

CREATING
COMPONENTS
THAT
SIMPLIFY
CIRCUITRY

M-100

molex

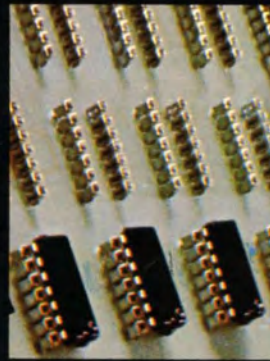
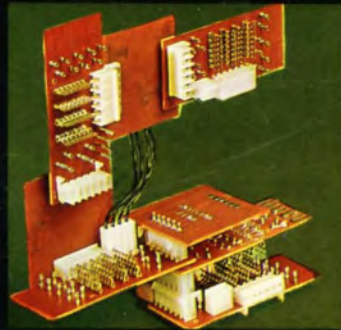

MOLEX INCORPORATED, LISLE, ILLINOIS 60532



Index

	Page
CONNECTORS – Plugs and Receptacles with Terminals	2-9
Flat Blade Connectors	7
International Pin Connectors	6
Miniature Pin Connectors	4-5
Phono Receptacle for PC Board	9
Relay Connector	8
Standard Pin Connectors	2-3
Switch, Miniature Snap-Action, Connectors	9
Tube and Socket Connectors	8
DISTRIBUTORS	22
INDEX	Inside Front Cover
INTRODUCTION	1
NEW PRODUCTS	Inside Front Cover
PRINTED CIRCUIT CONNECTORS AND TERMINALS	10-15
Board to Board Interconnections	10-12
Board to Chassis Interconnections	10-12
Konektcon Modular Interconnect System	10-11
Edgecon Edge Connectors	13
Inconnect	12
PRINTED CIRCUIT TERMINALS	14-15
Claspcn	15
IC Connections	14
Soldercon	14
Solder Tail Terminals	15
Transistor Connections	14
Wafercon	15
SWITCHES	16-18
Phonograph	18
Push Button, Lighted	16-17
Push Button/Receptacle	18
Rocker Type	18
Special Purpose	18
TECHNICAL CATALOGS	23
TECHNICAL AND SALES REPRESENTATIVES	
International	24
U. S. and Canada	Inside Back Cover
TOOLING	19-21
Crimping, Automatic Machines	21
Hand Tools, Crimping and Assembly	19
Vibrator Terminal Assembly Machines	20



KONEKTCON
PC Board
Connectors
Page 10



Removable
Lamp Push
Button Switch
Page 16



14-Circuit
Relay Socket
Page 8



PC Phono
Receptacle
Page 9



SOLDERCON
IC Connections
Page 14

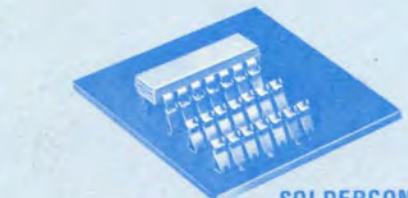

Terminal
"Nest"

Creating Components That Simplify Circuitry

Connectors, Terminals, Interconnection Systems, Modular Connecting Devices Switching Components, Applications Tools. . .

These are our products . . .

But our business is creating them in the most usable shapes and forms imaginable . . . developing, designing, and engineering economical simplicity into electrical/electronic components . . . producing components that lower assembly, testing, and servicing costs . . . as they increase versatility and reliability.

This is what sets MOLEX apart from others in the field . . . the ability to create new concepts and translate these concepts into practical products, which save time, money, and man hours.

MOLEX was founded on these concepts in 1938 in Downers Grove, Illinois, near Chicago, and today, MOLEX electrical/electronic components are being used worldwide.

Every year, millions of MOLEX components become an integral part of electrical/electronic systems used in household appliances, computers, home entertainment units, business machines, communications equipment, automobiles, medical electronics, instrumentation, aircraft, vending machines, leisure-time vehicles, etc.

The components manufactured by MOLEX are a variety of stand-

ard and miniature terminating, connecting, and switching devices. MOLEX also offers and services a complete line of hand tools, semi-automatic, and fully automatic wire stripping and crimping machines.

But why do people responsible for so many leading products turn to MOLEX? ACTION!! It's as simple as that. MOLEX proves continuously that its "person-to-person" approach to problem solving saves time and money and provides its customers with products developed to meet their specific requirements. The MOLEX representative you deal with is experienced in solving connecting and switching problems . . . And he is backed up by a team of experts at the home office.

Your MOLEX man knows what will and will not work in a product and on the production line. If one of our standard products doesn't meet your parameters, he can get something off the drawing board and into production that will . . . for MOLEX people are not only knowledgeable but they have the facilities and the desire to meet your requirements. In service; in products; in action — MOLEX delivers. We want your business.



Connectors—Plugs and Receptacles with Terminals .093 STANDARD PIN CONNECTORS

Series 03-09 Nylon
Series 04-09 Phenolic

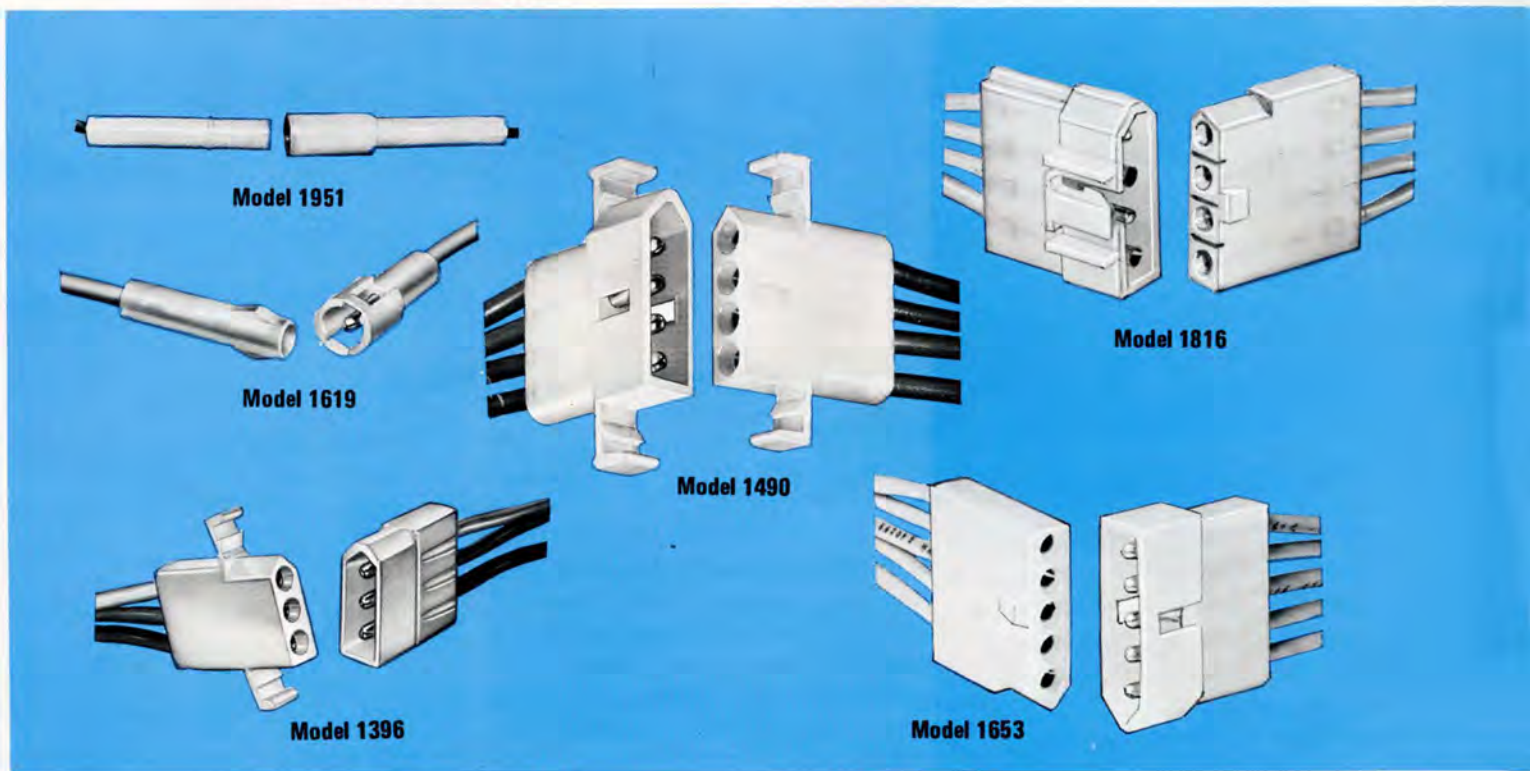

Molex connectors with crimped wire terminals are being specified for some of man's most exciting circuitry because they offer reliability, versatility, and economy. The Molex connector saves time and labor for mass production assembly, and provides a better mode of connection. Companies can produce sub-assemblies more economically in remote locations by using connectors to integrate components at final assembly.

A further advantage of Molex connectors is their use for making production line reliability checks. The plug-in connectors facilitate performance tests on the spot . . . for guaranteeing that components function properly.

Field installation and service of components connected by Molex connectors is easier and economical. Trouble-shooting and repair work is simplified.

Typical applications are for home appliances, automobiles, computers, vending dispensers,

business machines, home entertainment units, and instrumentation.

From 1 to 15 circuits can be connected by the molded nylon plugs and connecting receptacles. The series 04-09 phenolic connector, model 1055, houses 3 to 60 circuits in multiples of 3.

The .093-inch diameter terminals attach to 14- through 30-gauge insulated wire. Male and female terminal pins are easily crimped to wire leads with hand tools, semi-automatic bench machines, or high-speed machines that cut, strip, and crimp. The terminals lock into the connector, but are easily removed.

Molex standard pin connectors are UL and CSA listed for maximums of 250V and 12 amps per circuit for 1-3 circuits; 9 amps 4-9 circuits; and 7.5 amps 12-15 circuits. Nylon connectors operate to a maximum of 105° C. Maximum for phenolic is 325° F.

Model 1951 is a 1-circuit, high-

voltage connector rated for 5,000 volts and 12 amps.

Most of the nylon connectors have integrally molded mounting ears for snap-in, quick mounting of either the plug or receptacle in an .093-inch thick panel (note model 1261 detail). Most have a holding tab (model 1375 detail), and all are polarity keyed.

Male and female terminals may be assembled in either the plug or receptacle. Normally, male terminals are housed in the plug and mate with female terminals in the receptacle (models 1545/1360), but may be interchanged or mixed (models 1816 and 1375 detail).

Phenolic connectors can be mounted on panels with a jack screw assembly as shown (model 1055) or with a bracket or clip.

SPECIFICATIONS

Series 03-09 nylon 6/6

Models: 1951, 1619, 1545, 1396, 1490, 1292, 1360, 1375, 1261, 1653, 1816.

Circuits: 1, 2, 3, 4, 5, 6, 9, 12, 15 (model 1816 for 2, 3, or 4 circuits).



Model 1292



Model 1055

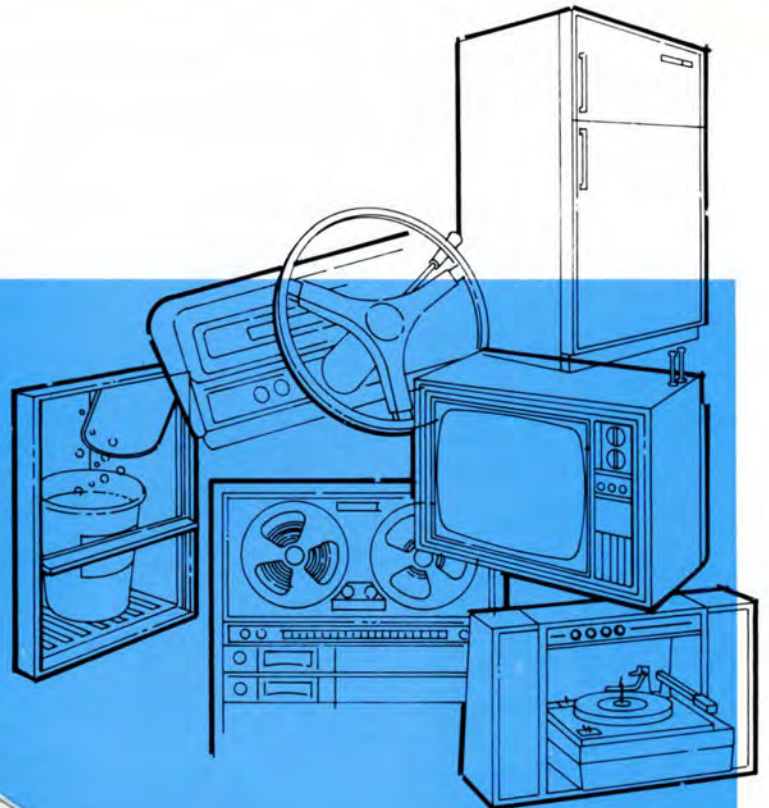

Terminal size: .093-in. dia. (2, 4mm), with crimp or PC tail.

Terminal material: Tin-plated brass, tin-plated phosphor bronze, modified copper, selective or overall gold plating.

Wire size: 14- through 30-gauge, insulated (model 1816 connects 18 gauge wire with 5/64-in. insulation).

Terminal crimping: Hand crimp tools, semi-automatic bench, or high-speed cut, strip, crimping machine (see pages 19-21).

Panel mounting: Mounting ears molded on most models for snap-lock mounting of plug or receptacle in .093-in. thick panel.

Locking device: Holding tabs on most models secure plug in receptacle.

Color: Standard nylon white, or at extra cost color dyed amber, black, blue, brown, green, grey, orange, red, yellow.

Series 04-09 Phenolic

Model: 1055.

Circuits: 3 through 60 in unit multiples of 3.

Terminals: Size, material, wire gauge, and crimping same as above.

Panel mounting: With nylon jack screw, metal bracket, or clip.

Color: Black

(For additional specifications and details see Molex catalog M200: CONNECTORS AND TERMINALS.)

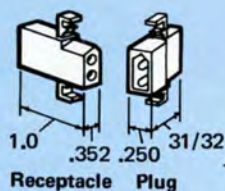

Model 1375 — Most models available with holding tabs and all are keyed for polarity. Male and female terminals may be intermixed.

◀ **Model 1545** — Typical overall dimensions.

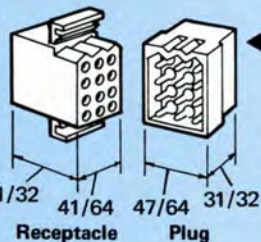
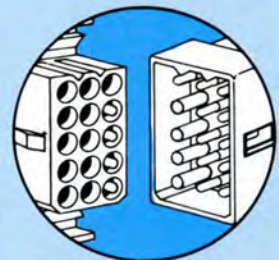

◀ **Model 1360** — Typical overall dimensions

Model 1261 — Molded ears provide quick snap-in mounting of plug or receptacle.

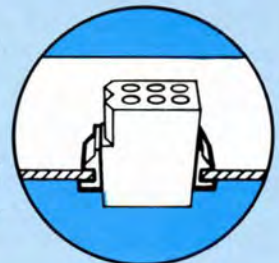

.093 TERMINALS

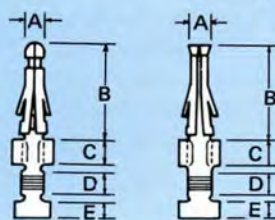

(Male)	Wire Gauge	(Female)
1190	14 through 20	1189
1380	18 through 22	1381
1434	24 through 30	1433
.093	A	.120
.468	B	.468
.125	C	.125
.125	D	.125
.078	E	.078



Connectors—Plugs and Receptacles with Terminals

.062 MINIATURE PIN CONNECTORS

Series 03-06 Nylon
Series 04-06 Phenolic

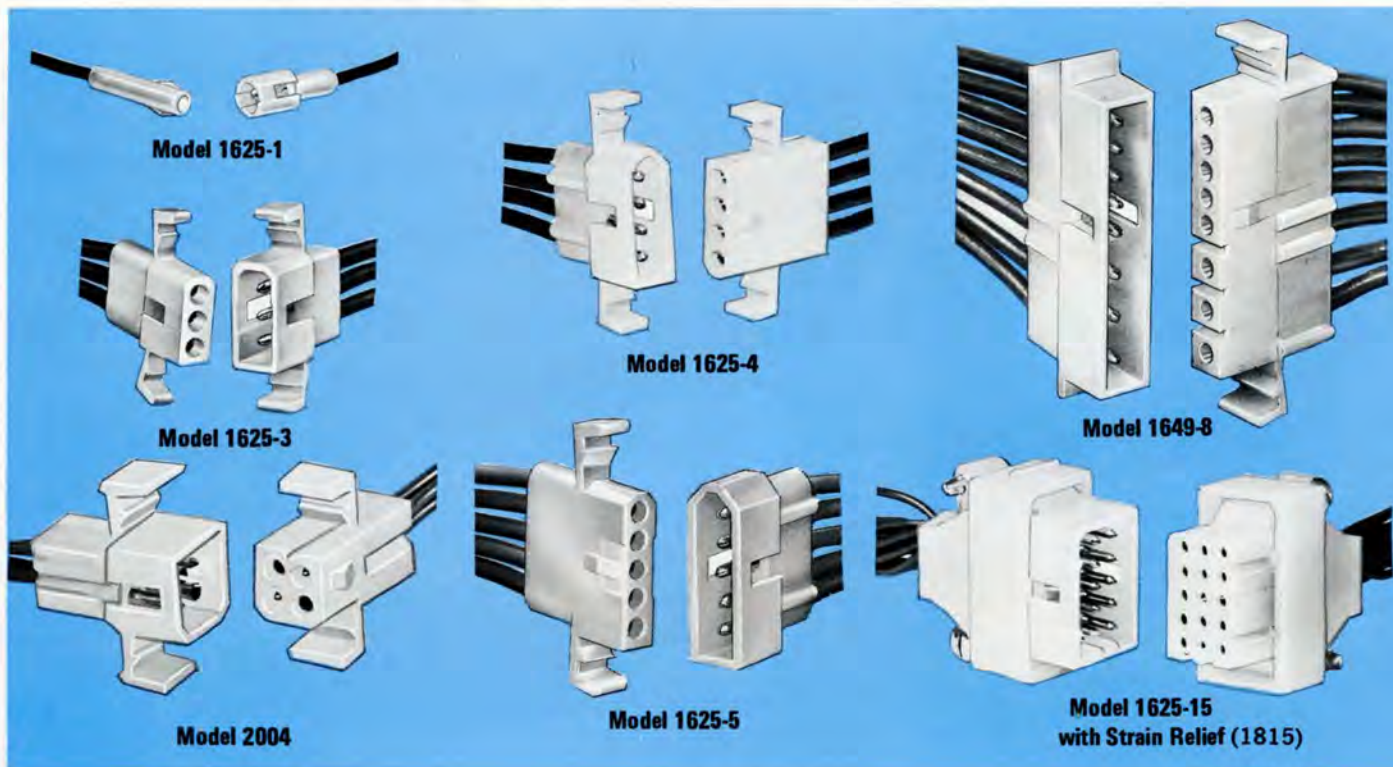

The demand for miniature connectors grows bigger by the day. Manufacturers of computers, business machines, portable appliances, communications equipment, etc., require smaller components; and Molex miniature connectors are meeting these demands.

The connectors have .062-inch diameter, crimp-type terminals for insulated wires ranging from 18-through 30-gauge. Terminals can be specified in different materials, including gold plate.

Hand tools, semi-automatic bench machines, or high-speed machines that cut, strip, and crimp can be used for attaching terminals to lead wires. The miniature terminals lock into the receptacle or plug, and easily are inserted or removed with simple hand tools. Molded nylon connectors are supplied for 1 through 36 circuits, and phenolic types for 4 through 104 circuits.

These connectors are UL and CSA listed for maximum use at 250V per circuit. They are designed for 5 amps per circuit for 1- to 15-circuit models, and 4 amps per circuit in the 24- and 36-circuit models. Molex miniature connectors of nylon function without loss of contact stability to maximum operating temperatures of 105° C, and to 325° F for phenolic types.

Male and female terminals can be inserted in either the plug or receptacle, or they can be intermixed (note models 2004 and 1625-9 detail). Normally, the male terminals are housed in the plug and mate with female terminals in the receptacle (models 1625-3 and 1625-6).

Most of the nylon connectors are available with integrally molded mounting ears (model 1625-12 detail) for quick snap-mounting of either plug or receptacle in a panel

of .060-inch maximum thickness.

Molded holding tabs (model 1625-9 detail) also offered on most of the nylon connectors, assure a strong connection.

Series 04-06 phenolic connectors can be mounted on panels with a jack screw assembly (model 1725) or bracket or clip.

Nylon connectors can be ordered in standard white, or, at a slight cost, dyed in any of nine Molex colors. Phenolic connectors come in black only.

SPECIFICATIONS

Series 03-06 nylon 6/6

Models: 1625, 1649, 1772, 2004

Circuits: 1, 2, 3, 4, 5, 6, 8 (model 1649), 9, 12, 15, 24, 36 (model 1772). Model 2004 in 4-circuit only.

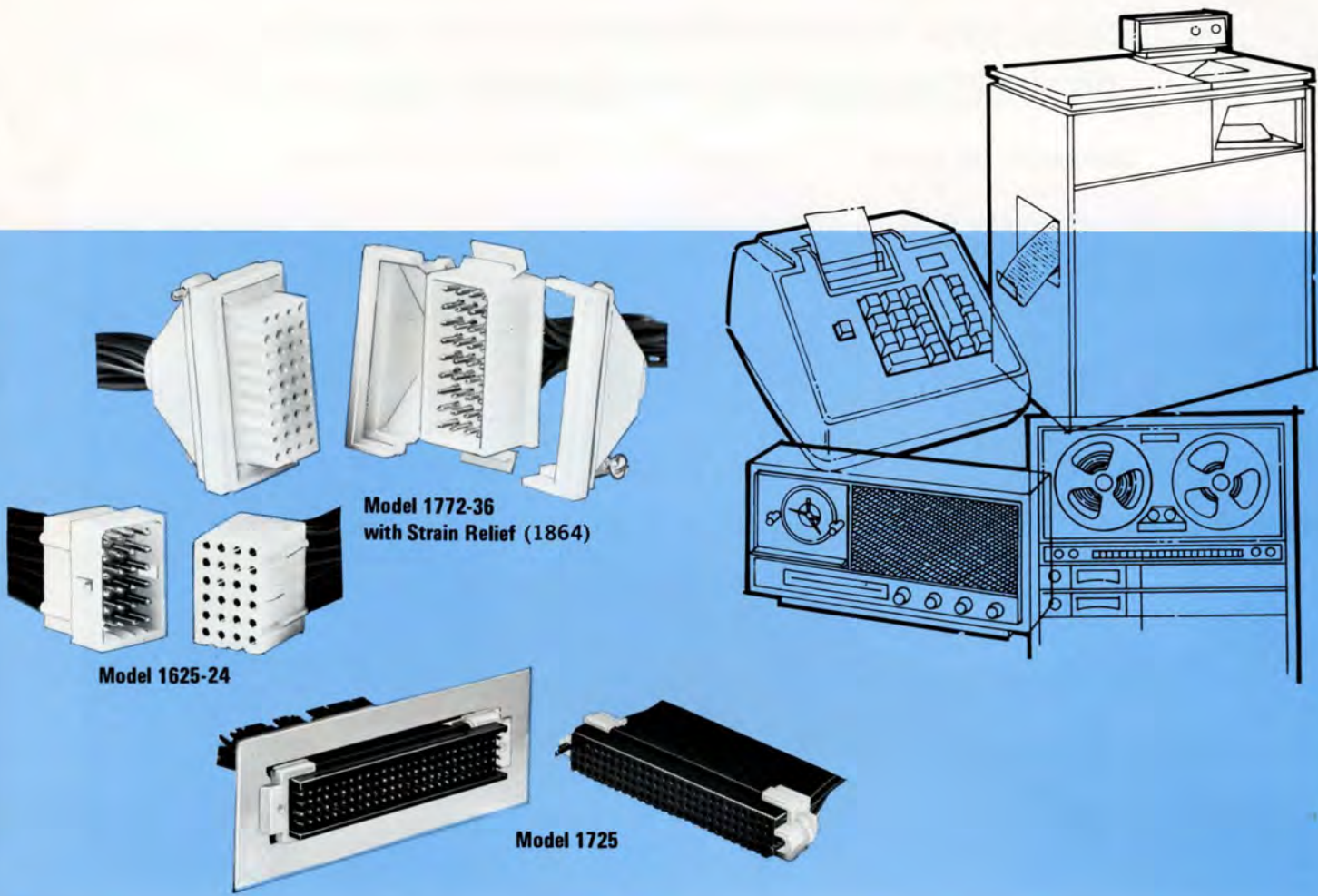

Terminal size: .062 in. dia. (1,6mm), with crimp tail.

Terminal material: Tin-plated brass, tin-plated phosphor bronze, selective or overall gold plating.

Wire size: 18- to 30-gauge, insulated.

Terminal crimping: Hand crimp tools, semi-automatic bench, or high-speed cut, strip, crimping machine (see pages 19-21).

Panel mounting: Mounting ears molded on most models for snap-lock mounting of plug or receptacle in .060-in. thick panel. 8-circuit model 1649 mounts in .062-in. panel.

Locking device: Holding tabs on most models secure plug in receptacle.

Color: Standard nylon white, or dyed at slight cost in nine available Molex colors.

Series 04-06 phenolic

Model: 1725

Circuits: 4 through 104 in unit multiples of 4.

Terminals: Size, material, wire size, and crimping same as above.

Panel mounting: Mount with nylon jack screw assembly, or metal bracket or clip.

Color: Black.

(For additional specifications and details see Molex catalog M200: CONNECTORS AND TERMINALS.)

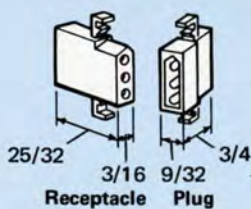

Model 1625-9 — Most models available with holding tabs and all are keyed for polarity. ▶
Male and female terminals may be intermixed.

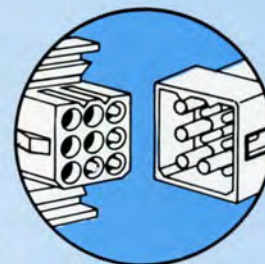

◀ **Model 1625-3** — Typical overall dimensions.

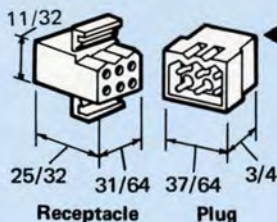

◀ **Model 1625-6** — Typical overall dimensions.

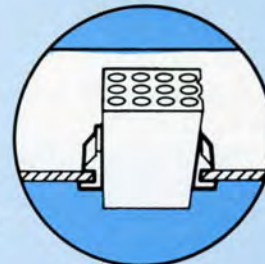

Model 1625-12 — Molded ears provide quick snap-in mounting of plug or receptacle. ▶

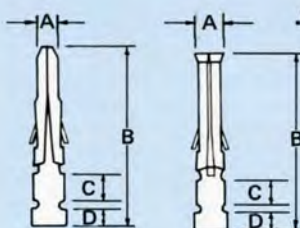

.062 TERMINALS

(Male)	Wire Gauge	(Female)
1854	24 through 30	1855
1560	18 through 22	1561
.062	A	.084/.080
.656	B	.640
.080	C	.080
.076	D	.076



Connectors—Plugs and Receptacles with Terminals .093 INTERNATIONAL PIN CONNECTORS

Series 19-09 Nylon

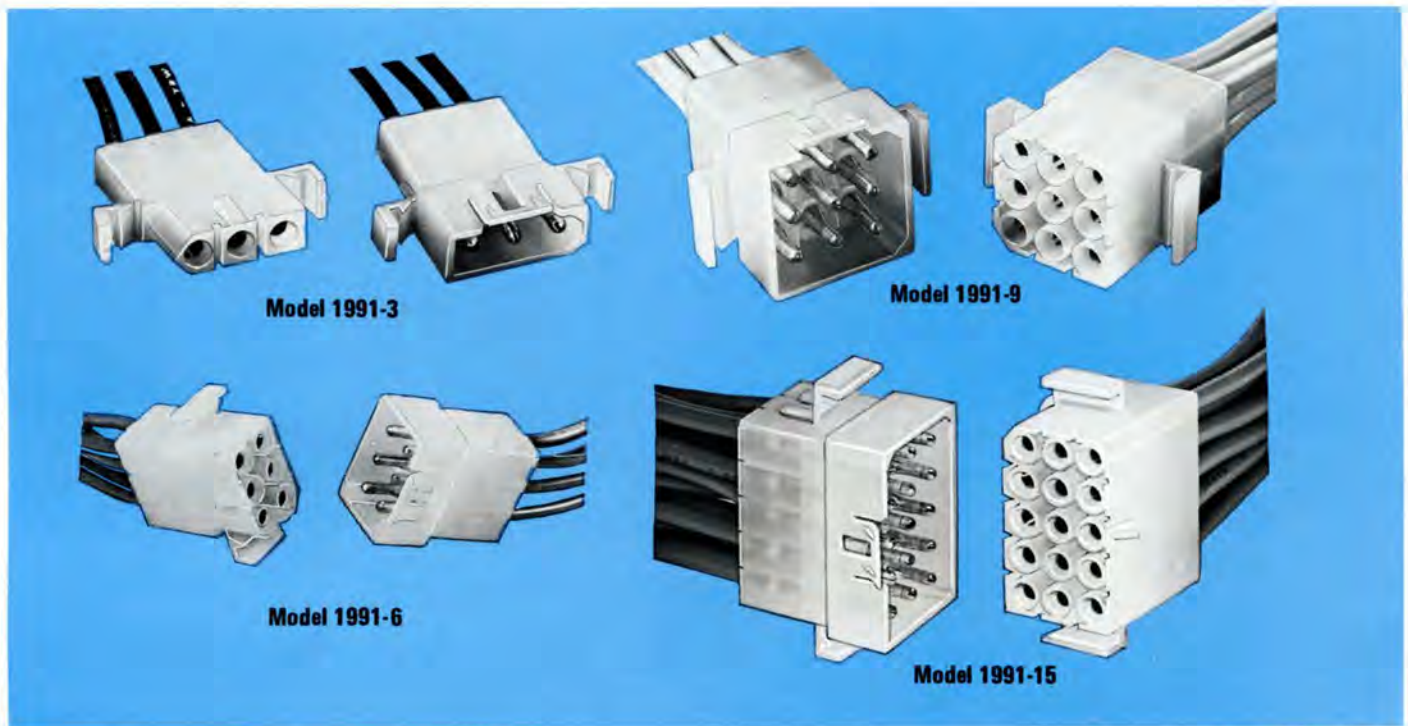

International connector specifications often vary from those of the U. S. The Molex international connector, series 19-09, meets foreign requirements with 3-, 6-, 9-, and 15-circuit 1991 molded nylon models. In addition a 12-circuit model is planned for production in the near future.

The 1991 connectors feature the Molex integrally molded receptacle/plug locking device and optional mounting ears for panel assembly. Their "egg-crate" housing design for terminal protection provides for 4mm over-surface spacing between terminals (note detail drawing), and 4mm spacing between the back of the connector and the end of the crimped terminal. Molex 1991 connectors are designed to meet European and Japanese requirements in addition to those of UL and CSA.

Terminals .093 inches in diameter (2,4mm), for 14- through 30-gauge insulated wire, can be specified in tin-plated brass, tin-plated phosphor bronze, selective and overall gold plating.

The connectors are UL listed, per circuit, for 600VAC at 11 amps (3 circuit), 9 amps (6-circuit), 8 amps (9-circuit), and 6 amps (15-circuit). They also accept heavier than usual insulation on leads.

SPECIFICATIONS

Series 19-09 nylon 6/6

Models: 1991-3, 1991-6, 1991-9, 1991-15.
Circuits: 3, 6, 9, 15 (query for 12-circuit availability).

Terminal size: .093-in. dia. (2,4mm).

Terminal material: Tin-plated brass, tin-plated phosphor bronze, selective or overall gold plating.

Wire size: 14- through 30-gauge, heavy insulation.

Amp rating: Per circuit at 600VAC: 11 amps (3-circuit), 9 amps (6-circuit), 8 amps (9-circuit), 6 amps (15-circuit).

Terminal crimping: Hand crimp tools, semi-automatic bench, or high-speed cut, strip, crimping machine (see pages 19-21).

Panel mounting: Mounting ears available optionally for snap-lock mounting of plug or receptacle in .062-in. (1,6mm) maximum thickness panel.

Locking device: Holding tabs secure plug in receptacle.

Color: Standard nylon white, or dyed at slight cost in nine available Molex colors.

(For additional specifications and details see Molex catalog M200: CONNECTORS AND TERMINALS.)

TYPICAL OVERALL DIMENSIONS

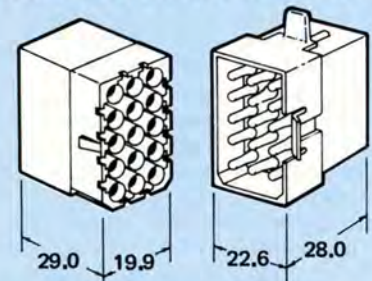

Receptacle and plug — available with or without mounting ears and positive holding tabs.

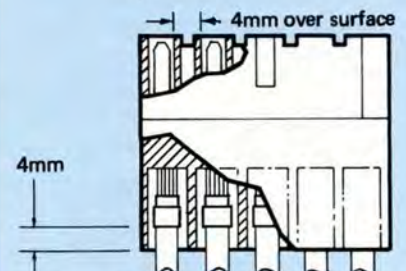

Terminal spacing meets CEE and VDE specifications.



Connectors—Plugs and Receptacles with Terminals

1/4-INCH FLAT BLADE CONNECTORS

Series 06-01 Nylon

Molex 1/4-inch flat blade series 06-01 connectors are for higher-current carrying applications; ones that draw a maximum of 18 amps per contact on a 250V circuit.

These connectors operate to a maximum temperature of 105° C. Low friction insertion and withdrawal, and keyed mating for positive polarity connection are other advantages. They are UL listed and approved in models for 2, 3, 4, 15, and 30 circuits.

Optional, integrally molded holding tabs can be specified on most models. Integrally molded mounting ears allow easy, snap-lock mounting into a panel of .062-inch maximum thickness. Model 1257 for 15 and 30 circuits requires metal mounting clips.

SPECIFICATIONS

Series 06-01 nylon 6/6

Models: 1184, 1183, 1181, 1257.

Circuits: 2, 3, 4, 15, 30.

Terminal size: 1/4-in. wide (6.4mm).

Terminal material: tin-plated brass.

Wire size: 10- through 20-gauge, insulated.

Amp rating: 18 amps maximum per contact, 250V.

Terminal crimping: Hand crimp tools, semi-automatic bench, or high-speed cut, strip, crimping machines (see pages 19-21).

Panel mounting: Integrally molded mounting ears for snap-lock mounting in .062-in. (1.6mm) maximum thickness panel.

Locking device: Optional holding tabs on most models.

Color: Standard nylon white, or dyed in nine available Molex colors at slight cost.

(For additional specifications and details refer to Molex catalog M200: CONNECTORS AND TERMINALS.)

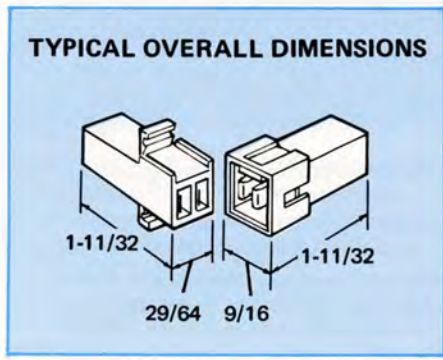
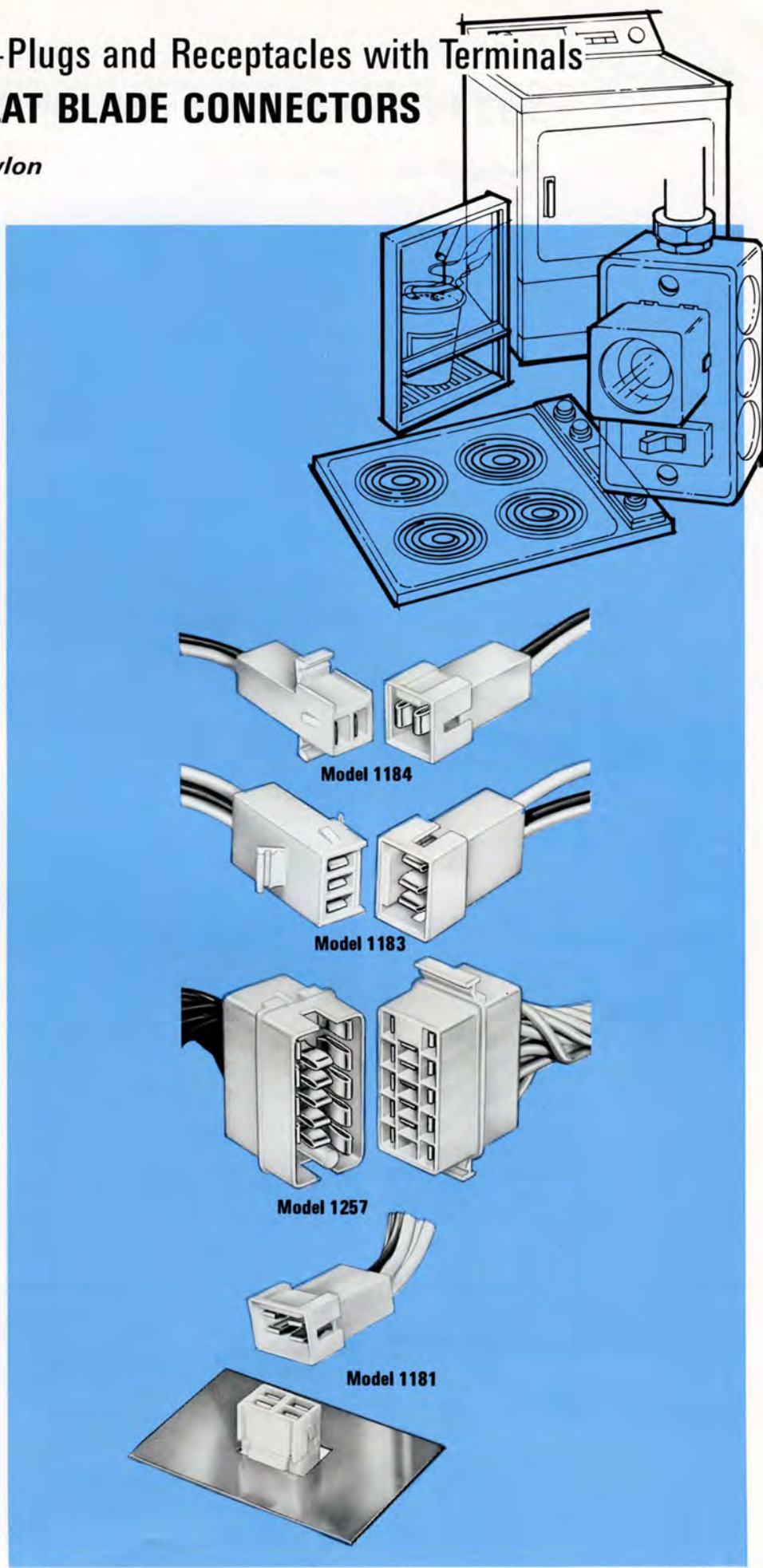



Connectors

RELAY, TUBE AND SOCKET CONNECTORS

Series 03-09 Series 06-02

A 14-circuit relay connector of molded nylon material houses completely-insulated Molex crimp-type miniature terminals. The .100-inch, spring-tempered, tin-plated brass terminals can be crimped to 18-through 24-gauge wire. This series 06-02 model 1852 relay connector can be mounted in a panel up to .093-inch maximum thickness. The usual standard relay mounting screw fits into a socket opening, which is designed as a friction lock, and is held firmly in the socket.

Tube and socket receptacles for 8, 9, and 11 circuits provide for standard crimp-type .093-inch diameter terminals for 14- through 30-gauge insulated wire.

Molex tube and relay receptacles may be mounted in .093-inch, or .062-inch, maximum thickness panels.

A tube and socket plug, model 1664, also is available for a nine-circuit connection.

SPECIFICATIONS

RELAY CONNECTOR

Series 06-02 nylon 6/6

Models: 1852.

Circuits: 14.

Terminal size: .100-in. flat.

Terminal material: Spring-tempered, tin-plated brass.

Wire size: 18- through 24-gauge, insulated.

Terminal crimping: Hand-crimp tools, semi-automatic bench, or high-speed cut, strip, crimping machine (see pages 19-21).

Panel mounting: Molded single ear for snap-mounting in .093-in. (2,4mm) thickness panel.

Locking device: Relay screw anchored by connector friction lock.

Color: Standard nylon white, or at slight cost, dyed in nine available Molex colors.

TUBE AND SOCKET CONNECTORS

Series 03-9 nylon 6/6

Models: 1412, 1664.

Circuits: 8, 9, 11 (model 1664 tube and relay socket 9-circuit only).

Terminal size: .093-in. dia. (2,4mm).

Terminal material: Tin-plated brass, phosphor bronze, modified copper, overall gold plating.

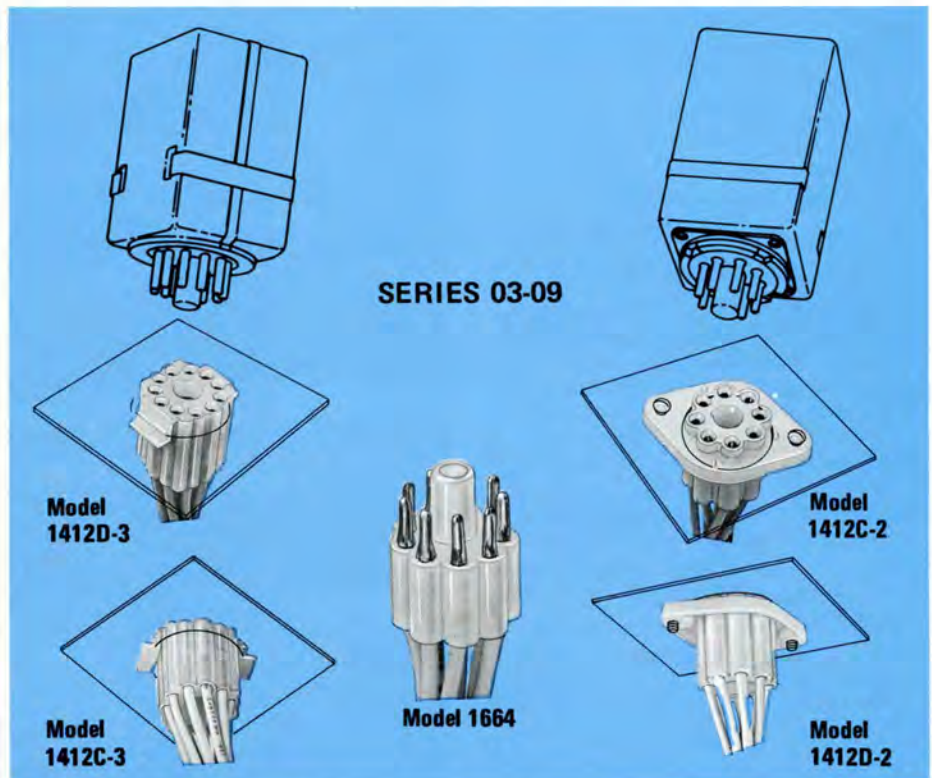
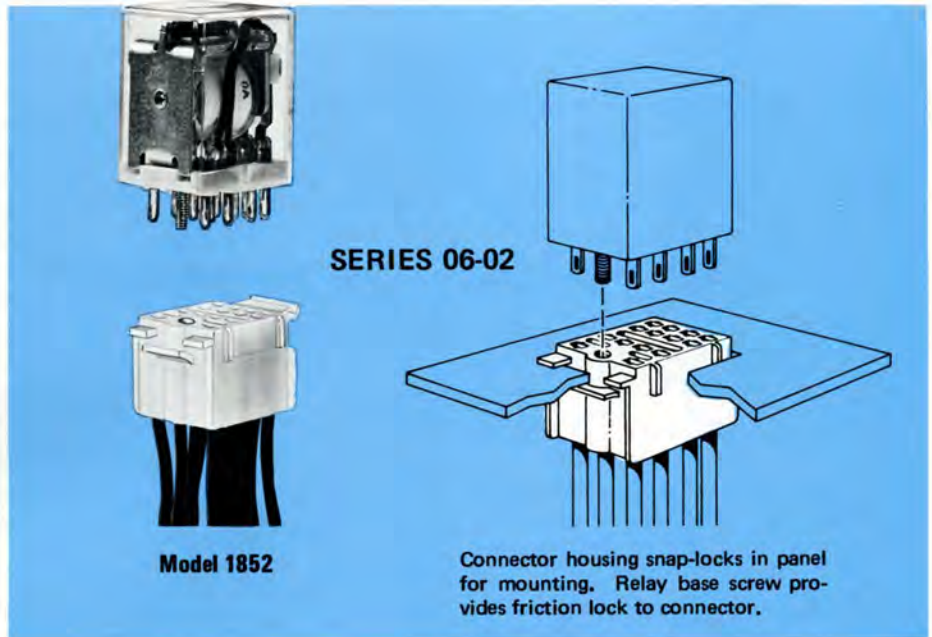

Wire size: 14- through 30-gauge, insulated.

Terminal crimping: Hand-crimp tools, semi-automatic bench, or high-speed cut, strip, crimping machine (see pages 19-21).

Panel mounting: Model 1412 tube and relay receptacles with optional mounting ears, or screw flanges for above or below panel mounting. Mount in .093-in. (2,4mm) or

.062-in. (1,6mm) maximum thickness panel.

Color: Standard nylon white, or at slight cost, dyed in nine available Molex colors.

(For additional specifications and details see Molex catalog M200: CONNECTORS AND TERMINALS, or Sales Technical Data Sheets.)



Connectors

MINIATURE SNAP-ACTION SWITCH CONNECTORS

Series 06-02 Nylon

A nylon-molded Molex connector for either 1 or 3 circuits for miniature snap-action switches is UL listed for up to 10 amps, and maximum operating temperature to 105° C. The model 2211 and 2191 switch connectors house 3/16-inch flat, spring-type terminals.

SPECIFICATIONS

Series 06-02 nylon 6/6

Models: 2211, 2191.

Circuits: 1, 3.

Terminal size: 3/16-in, flat.

Terminal material: Tin-plated brass.

Wire size: 18- through 22-gauge, insulated.

Terminal crimping: Hand-crimp tools, semi-automatic bench, or high-speed cut, strip, crimping machine (see pages 19-21).

Color: Standard nylon white, or at slight cost, dyed in nine available Molex colors.

(For additional specifications and details see Molex catalog M200: CONNECTORS AND TERMINALS, or Sales Technical Data Sheets.)

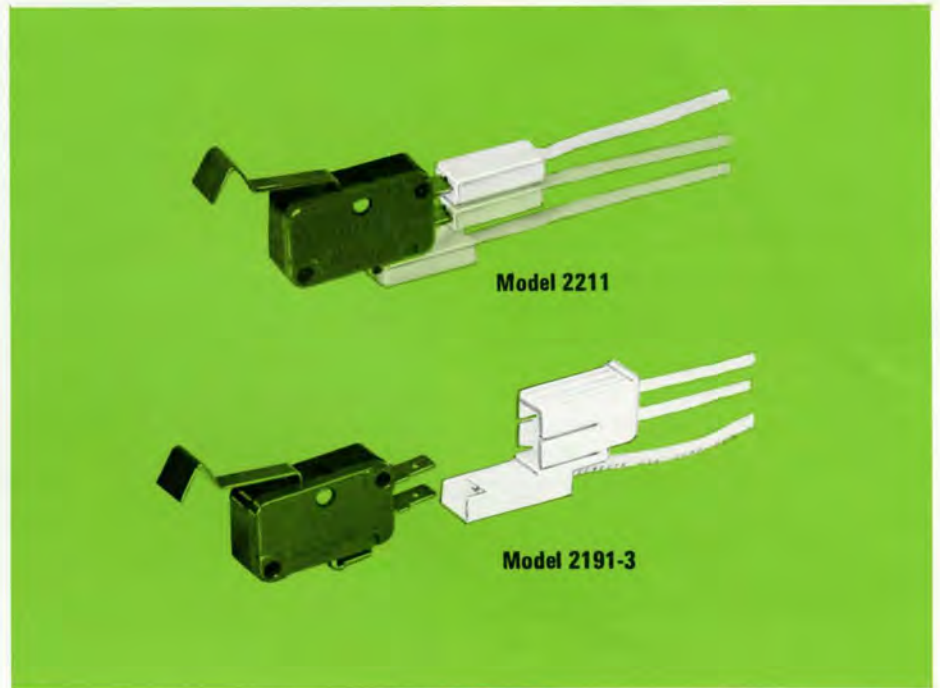

PC PHONO RECEPTACLE

Series 15-24

The Molex PC board receptacle assembly for a phonograph jack is of molded nylon, with a hard-temper, tin-plated outer shell and snap-in solder tabs for mounting. The receptacle can be assembled on a PC board to .062-inch maximum thickness. It extends 3/8 inches above. A clearance hole allows for any length jack insertion. The receptacle is UL listed, and operates to a maximum temperature of 105° C.

SPECIFICATIONS

Series 15-24

Models: 2181.

Circuits: 1.

Terminal size: For standard phonograph jack.

Terminal material: Tin-plated brass.

Panel mounting: Snap-in tabs for PC board soldering. Maximum panel board thickness .062-in. (1,6mm).

(For additional specifications and details see Molex catalog M400: CONNECTORS AND TERMINALS, or Sales Technical Data Sheets.)

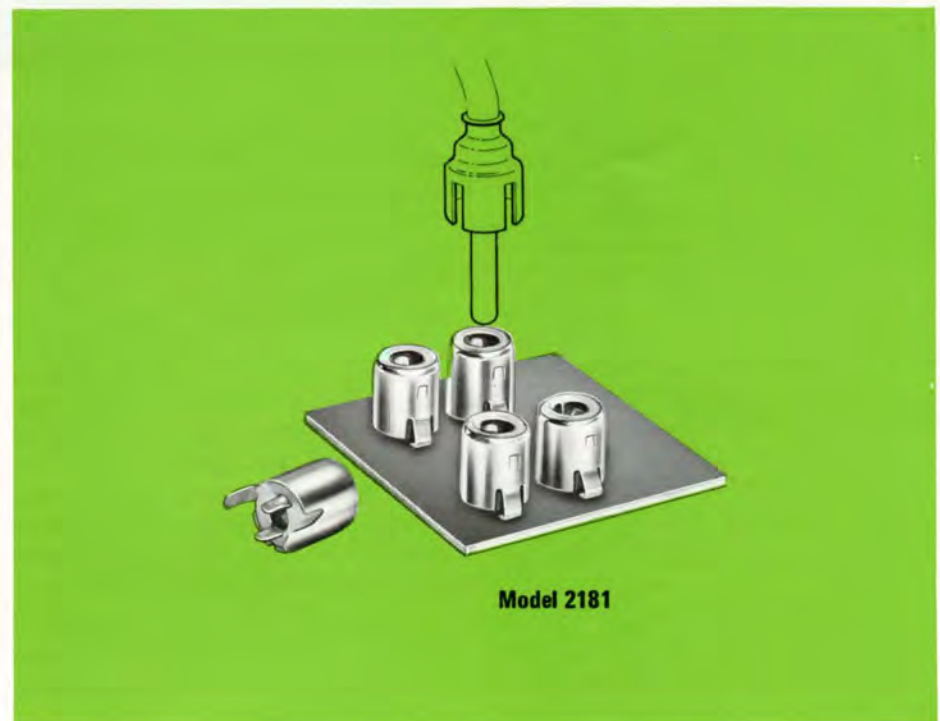



Printed Circuit Connectors and Terminals

KONEKTCON[®] Board and Chassis Connections

Series 09-50/52/57/60/64/65 Series 08-50 Series 08-54

Konektcon is a versatile and adaptable interconnecting system designed by Molex for almost any printed circuit requirement.

The system is unlike anything else available to the assembler of printed circuits, and the exponent of modularization.

The Konektcon system makes possible almost any form of board-to-board, board-to-component, and chassis-to-board PC connection. Four basic connectors, using their assembled male or female terminals in various modes, permit the designer to complete the most complex of interconnections.

Konektcon is built around the unique Molex use of .045-inch rigid square wire male pins (series 08-54). These tin-plated pins can be specified in 1/2-inch to 2-inch lengths, permitting a stacking arrangement for multiple board connections to the same circuits. By using the Molex vibration assembly method (see page 20), pins are positioned into a .050-inch diameter hole at a rate of up to 300 per minute, and then wave soldered.

A round male pin, 0.45 inches in diameter and mounted in a nylon support wafer, also can be used. No special staking equipment is needed. The pin is supplied in specified lengths from 3/4-inch to 1-3/8-inches for 2 through 18 circuits (model 09-64). Pins are on .156-inch centers. A similar wafer (series 09-65) for round male pins has an added friction locking device. This snaps over a molded ramp on the female connector (recommended with less than six circuits).

A locking, snap-in wafer for chassis mounting (series 09-57) and a polarizing wafer for board positioning (series 09-60) are available also.

Three assemblies with female terminals on .156-inch centers with many variations available are used for connecting cable-to-board;



board-to-board, parallel; board-to-board, perpendicular; board-to-chassis; and for three-circuit power transistor connections.

Crimp or PC board solder tail female terminals are available. Crimp-type terminals are used in the cable-to-board connectors (series 09-50) in various units for 3 to 24 circuits, and for power transistor connections (series 09-52-3030). These terminals can be crimped to 22- through 26-gauge wire, or 18- through 22-gauge. The 3-circuit model with mounting ears (09-50-4031) snap-locks into a .062-inch (1.6mm) panel.

Terminals can be crimped with Molex hand tools, semi-automatic, and high-speed automatic cut, strip, crimping machines.

Board edge connectors with crimped terminal leads (series 09-50) mate with .062-inch thick boards.

SPECIFICATIONS

HARNESS CONNECTOR

Series 09-50 nylon 6/6

Models: 2139.

Circuits: 3, 4, 5, 6, 8, 12, 15, 24.

Terminal type: Double cantilever bellows crimp type.

Terminal material: Tin-plated brass, selective or overall gold plating.

Wire size: Terminals 2478 crimp 18- through 22-gauge insulated wire; terminals 2578 crimp 22- through 26-gauge wire.

Terminal spacing: .156-in. centers.

Panel mounting: 3-circuit with molded-on mounting ears snap-locks into panel .062-in. (1.6mm) thick.

Locking device: Molded edge locking ramp: 2, 3, 4, 5, 6, 8, 9, 12, 15, 24 circuits.



09-52 Models

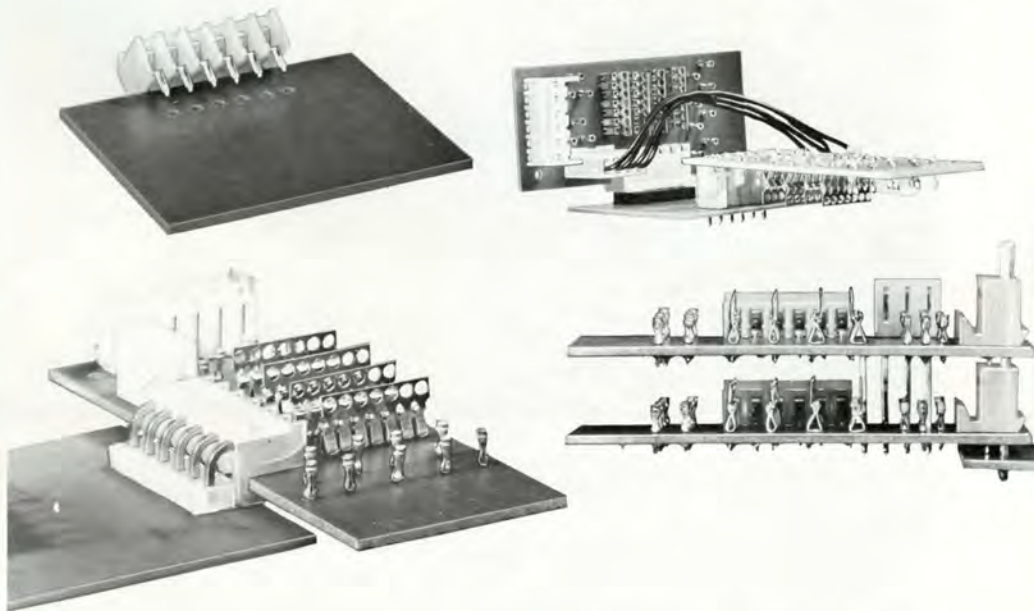
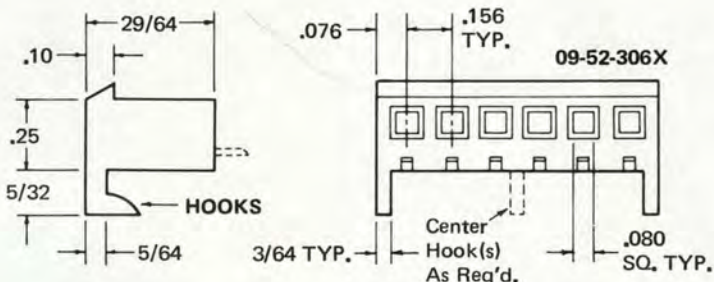
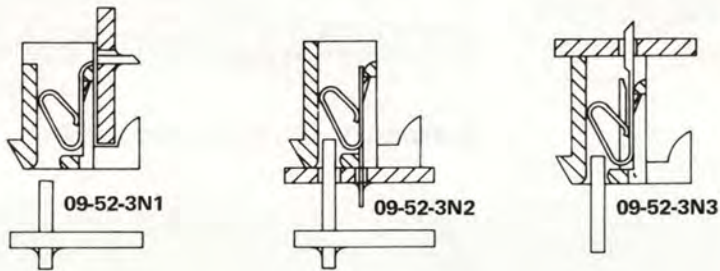

BOARD INTERCONNECTORS

Series 09-52 nylon 6/6

Models: 2145 A, B & C.

Circuits: 3, 4, 6, 8, 10.

Terminal type: Double cantilever bellows type with solder tail.

Terminal material: Brass, with tin plating or overall gold plating.

Terminal spacing: .156-in. centers.

Panel mounting: Terminals extend horizontally one side or vertically (up or down) through connector for soldering to parallel or perpendicular board.

Locking device: Molded edge locking ramp; molded hook support for stabilizing board.

WAFER INTERCONNECTORS

Series 09-57/60/64/65 nylon 6/6

Models: A2220, A2403, A2402, A2391.

Circuits: 2 through 18 with or without friction lock (friction lock unavailable for chassis-mount series 09-57).

Pin size: .045-in. dia. or .045-in. square wire, 3/4-in. through 1-3/8-in. long.

Pin material: Brass, with tin plating or overall gold plating.

Pin spacing: .156-in. centers.

Panel mounting: Pins extend from wafer through board for soldering in board of .062-in. (1,6mm) Maximum thickness.

POWER TRANSISTOR CONNECTORS

Series 09-50 and 09-52 nylon 6/6

Models: 2139-31, A2169.

Circuits: 3.

Terminal type: .045-in. double cantilever bellows type with .080-in. square contact opening: 09-50 crimp type; 09-52 solder tail.

Terminal material: Brass, with tin plating or overall gold plating.

Panel mounting: Terminals extend through connector with solder tails for board mounting. Optional molded ears for snap-lock mounting in panel of .062-in. (1,6mm) maximum thickness.

(For additional specifications and details see Molex catalog M400: PRINTED CIRCUIT CONNECTIONS, or Sales Technical Data Sheets.)

MALE PIN SPECIFICATIONS

Series 08-54

Models: 2161.

Size: 1/2, 3/4, 15/16, 1-3/16, 1-3/8, .045-in. square wire.

Material: Brass, with tin plating or overall gold plating.

Assembly: Vibration positioning with template for staking into .050-in. dia. PC board hole and soldering (see page 20). (Round wire .045-in. dia. can be substituted, preassembled for board soldering in nylon interconnection wafer, see series 09-64/65).



Printed Circuit Connectors and Terminals

INCONNECT® Board and Chassis Connections

Series 09-08 Series 09-18

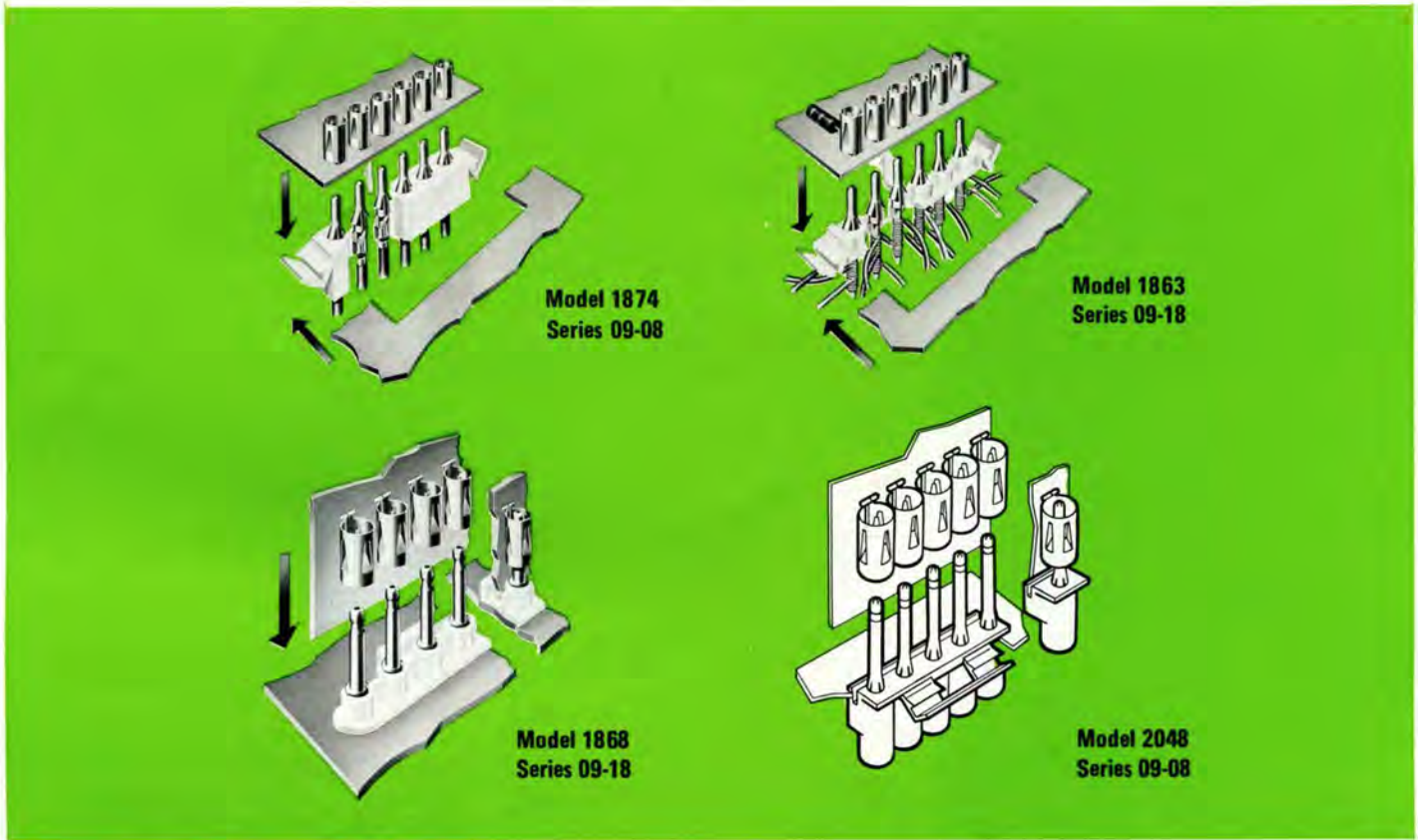

A fast production and assembly system for modular interconnection of electrical and electronic PC assemblies . . . that's Inconnect.

For the designer; Inconnect liberalizes flexibility for modularization and enhances reliability of connections. This system also reduces assembly testing and servicing costs. Model changes are simplified, and the rugged construction of the components allows for wide tolerance in connections.

Housings for the six-circuit male terminal components are of molded nylon material.

Basic applications are: parallel male board connections using .093-inch diameter crimp-type terminals (model 1874) and pre-assembled units for wire-wrapping (model 1863); perpendicular board connections with pre-assembled round pins (model 1868); perpendicular chassis-to-male board with male crimp-type terminals (model 2048).

Terminals can be obtained in several materials, for 18- through 22-gauge wire. Parallel assemblies are designed with .250-inch terminal centers, and snap-lock into board cutouts. The perpendicular connection employs male terminals that stake for soldering to the Inconnect assembly, with .300-inch centers.

SPECIFICATIONS

Series 09-08

Models: 1874, 2048.

Circuits: 6.

Terminal size: .093-in. dia. crimp type.

Terminal material: Tin-plated brass, selective or overall gold plating.

Wire size: 18- through 22-gauge insulated wire.

Terminal spacing: .250-in. centers.

Terminal crimping: Hand-crimp tools, semi-automatic bench, or high-speed cut, strip, crimping machine (see pages 19-21).

Panel mounting: End snap-lock ears for chassis cutout mounting, parallel board/chassis connection (model 1874); side

snap-lock ears for chassis cutout mounting, perpendicular board/chassis connection (model 2048).

Locking device: Optional molded through-board locking arm (model 1874), integral aligning and holding track (model 2048).

Series 09-18

Models: 1863, 1868.

Circuits: 6.

Terminal size: Pre-assembled .093-in. dia. for wire wrapping (model 1863); pre-assembled .093-in. dia. round pin.

Terminal material: Same as above except model 1868 tin-plated brass only.

Wire size: 18- through 22-gauge insulated wire (model 1863).

Terminal spacing: .250-in. centers, except .300-in. center for model 1868.

Terminal crimping: Same as above (not applicable model 1868).

Panel mounting: Model 1863 has end snap-lock ears for chassis cutout mounting, parallel board/chassis connection; model 1868 stakes for soldering.

Locking device: As above, locking arm (model 1863), aligning track (model 1868).

(For additional specifications and details see Molex catalog M400: PRINTED CIRCUIT CONNECTIONS.)



Printed Circuit Connectors and Terminals

EDGECON[®] Edge Connectors

Series 09-01 Series 09-02

Fast assembly, reliability, and economy are the major benefits in using Edgecon, straight-on and right-angle Molex edge connectors.

The color-coded nylon housings are designed for 5 through 24 circuits. Individual terminals are on .156-inch spacing with each circuit rated to 10 amps maximum, for 18-through 30-gauge wire.

Edgecon connectors mate with PC boards of .063-inch thickness. The Molex bifurcated flat terminal makes excellent contact with both board terminal contact faces. Terminals are available in loose or chain form for hand or machine crimping.

SPECIFICATIONS

Series 09-01 nylon 6/6

Models: 1796 straight-on.

Circuits: 6, 9, 12, 15, 18, 21, 22, 24, with .156-in. spacing.

Terminal material: Tin-plated brass, tin-plated phosphor bronze, selective or overall gold plating on nickel.

Wire size: 18- through 30-gauge, insulated, depending on terminal.

Terminal rating: 10 amps maximum per circuit.

Terminal crimping: Hand-crimp tools, semi-automatic bench, or high-speed cut, strip, crimping machine (see pages 19-21).

Panel mounting: .125-in. dia. hole end flanges optional.

Board thickness: .063-in. \pm .008 in.

Color: Standard nylon white, or at slight cost, dyed in nine available Molex colors.

Series 09-02 nylon 6/6

Models: 1800M right angle.

Circuits: 9, 15, 18, 21, 22, with .156-in. spacing.

Terminal material: See above.

Wire size: 18- through 24-gauge insulated, depending on terminal.

Terminal rating: See above.

Terminal crimping: Hand-crimp tools, semi-automatic bench, or high-speed cut, strip, crimping machine (see pages 19-21).

Panel mounting: .156-in. dia. hole end flanges — optional without flanges 18-circuit only.

Board thickness: .063-in. \pm .005 in.

Color: See above.

(For additional specifications and details see Molex Catalog M400: PRINTED CIRCUIT CONNECTIONS.)

SERIES 09-01

Model 1796

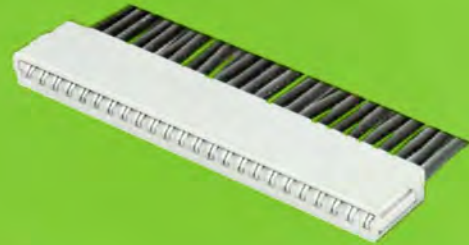

Model 1796-1

SERIES 09-02

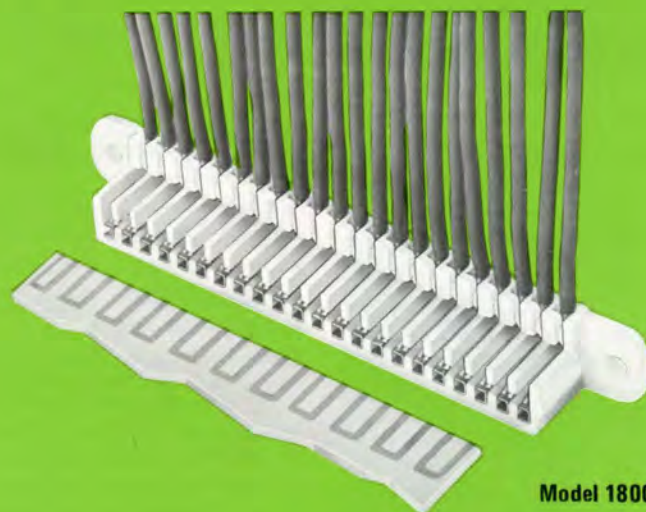

Model 1800M



Printed Circuit Terminals

SOLDERCON[®] IC Connections

Series 02-04 Series 05-30/35 Series 05-40/45

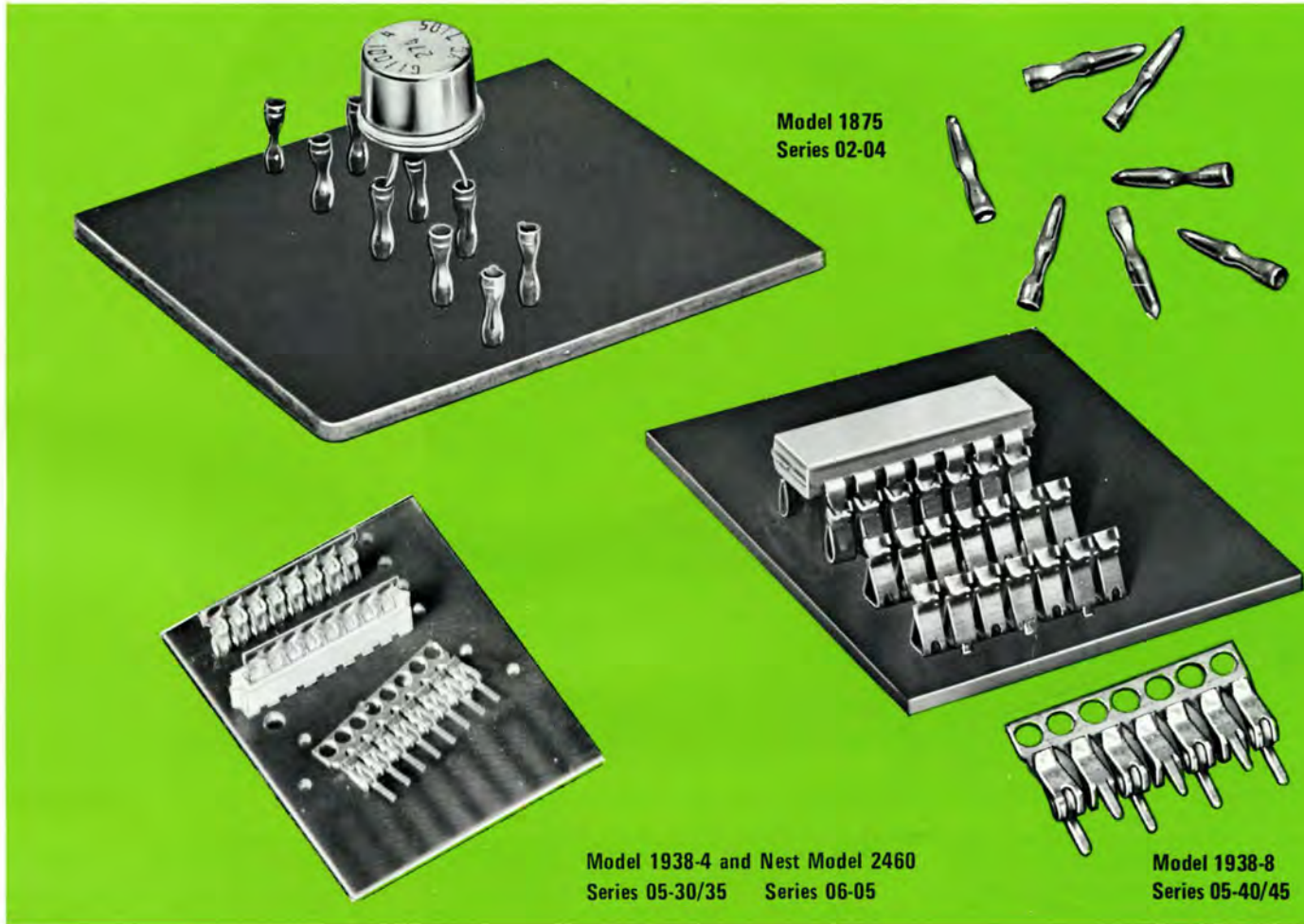

Model 1875
Series 02-04

Model 1938-4 and Nest Model 2460
Series 05-30/35 Series 06-05

Model 1938-8
Series 05-40/45

Soldercon terminals provide the advantage of plug-in packages for connecting transistor and integrated circuits with economy.

The Molex (series 02-04 female) transistor terminal can be assembled for soldering several hundred at a time using Molex vibrator equipment (see page 20) and can be positioned in any desired configuration. For ease of assembly, they have a lead opening of .015/.020 inches in diameter. No connecting insulator is required.

Soldercon IC terminals optionally in-line (series 05-30/35) with assembly nest (series 06-05) or staggered (series 05-40/45) configurations have .007/.011 x .018/.030-inch lead openings. Chain form or pre-cut terminal strips can be specified.

SPECIFICATIONS

Series 02-04

Model: 1875.

Type: Round female transistor socket type; takes .015/.020-in. dia. leads. Rises .197 in. above board.

Terminal material: Tin-plated brass.

Assembly: Press-fitted and soldered to board.

Terminal spacing: .090-in. minimum.

Series 05-30/35 Series 05-40/45

Models: 1938-4, 1938-8.

Type: Rectangular female IC type; for .007/.011 x .018/.030-in. leads. Rises .180 in. above board.

Terminal material: Tin-plated brass, phosphor bronze, or gold-plated over nickel.

Assembly: Soldered in strips for straight-line (model 1938-4) or staggered (model 1938-8) for IC mating.

Terminal spacing: .100 in. on centers; 200 in minimum between rows.

(For additional specifications and details, see Molex Catalog M400: PRINTED CIRCUIT CONNECTIONS.)

Terminals furnished in chain form; carrier breaks off after soldering.

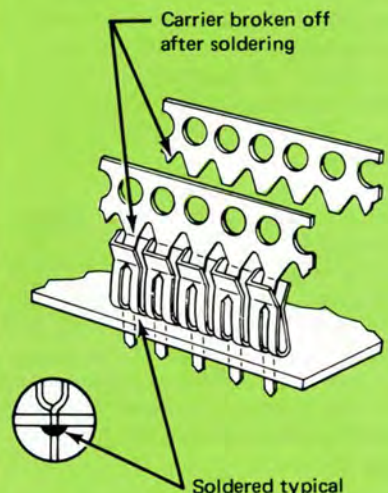



Printed Circuit Terminals CLASPCON[®] PC Connections

Series 02-05
Series 02-08

Single printed circuit board connections are mated easily with the rugged, simply designed Claspcon terminals. It is one of the most economical ways for making removable connections to printed circuit boards. These terminals are also useful where circuits cannot easily be brought to the board edge for connection. Both series are crimp types. Series 02-05 mates with .045-inch square-wire terminals, and series 02-08 with .093-inch diameter round-pin terminals.

SPECIFICATIONS

Series 02-05 Series 02-08

Models: 1929, 1881

Type: Round female crimp type for .045-in. square post (02-05); round female crimp type for .093-in. round pin (02-08).

Terminal material: Tin-plated brass; selective gold-plating over nickel model 02-05 only.

Wire size: 18- through 30-gauge (02-05); 16- through 28-gauge (02-08), insulated.

Assembly: Connect with board-staked male terminal.

Terminal crimping: Hand crimp tools, semi-automatic bench, or high-speed, cut, strip, crimp machine (see pages 19-21).

(For additional specifications and details, see Molex Catalog M400: PRINTED CIRCUIT CONNECTIONS.)



Model 1929

Model 1881



WAFERCON[®] PC Connections

Series 09-18

Wafercon provides a printed circuit board connector that speeds production, testing, and servicing. The Wafercon series 09-18 is available in units ranging from 3 to 12 circuits. Terminals mate with Molex .093 crimp type terminals.

An intermix of male and female terminals assures error-free connections and positive polarity. This series of products is not available for all applications. Check with your local representative or Molex Incorporated for details.

SPECIFICATIONS

Series 09-18 nylon 6/6

Model: 1840

Circuits: 3, 5, 6, 9, 12 assembled in 3/32-in. thick nylon wafer.

Type: .093-in. dia. with solder tail.

Terminal material: Tin-plated brass.

Assembly: Press-fit for board soldering.

Color: Standard nylon white or, at slight cost, dyed in nine available Molex colors.

(For additional specifications and details, see Molex Catalog M400: PRINTED CIRCUIT CONNECTIONS.)

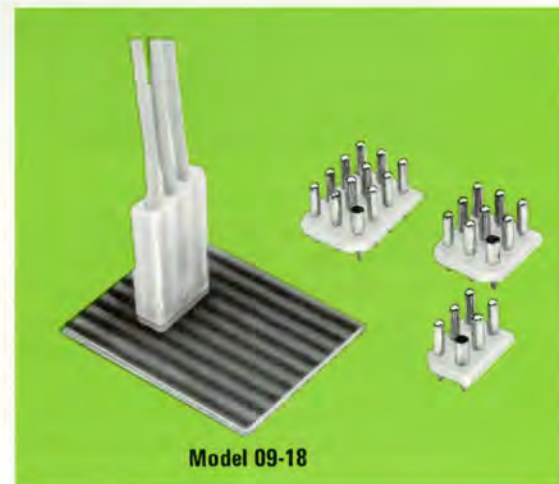

Model 09-18



.093 PC SOLDER TAIL TERMINALS

Series 02-09

Nylon-housed standard .093-inch diameter tin-plated brass male or female PC terminals with solder tails interface with Molex crimped terminal harness connectors. Either the female (model 1376) or the male (model 1377) is assembled in a nylon housing, for insertion into a PC board and dip soldering, for one- through 15-circuit connections. Housing the terminals in a connector avoids board damage. Mixing male and female terminals on the board assures error-free connections.

SPECIFICATIONS

Series 02-09

Models: 1376, 1377.

Circuits: 1 through 15 assembled in Molex standard 03-09 nylon connector.

Terminal size: .093-in. dia. with solder tail.

Terminal material: Tin-plated brass.

Assembly: Housed in plug or receptacle, press-fitted and soldered.

(For additional specifications and details, see Molex Catalog M400: PRINTED CIRCUIT CONNECTIONS.)

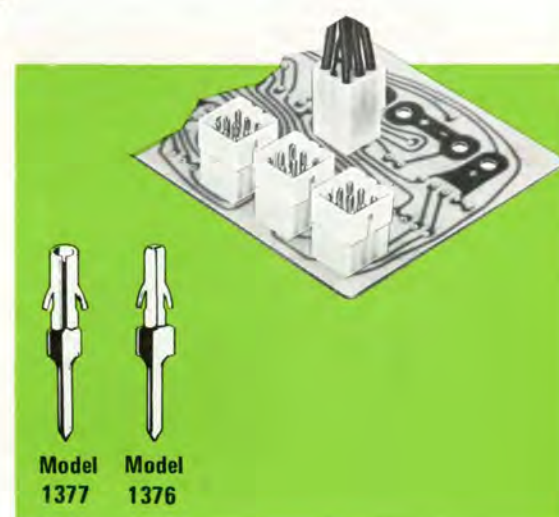

Model 1377

Model 1376



Switches

MODEL 1820 LIGHTED PUSH BUTTON SWITCHES

Series 01-50/60

Series 21-50/60

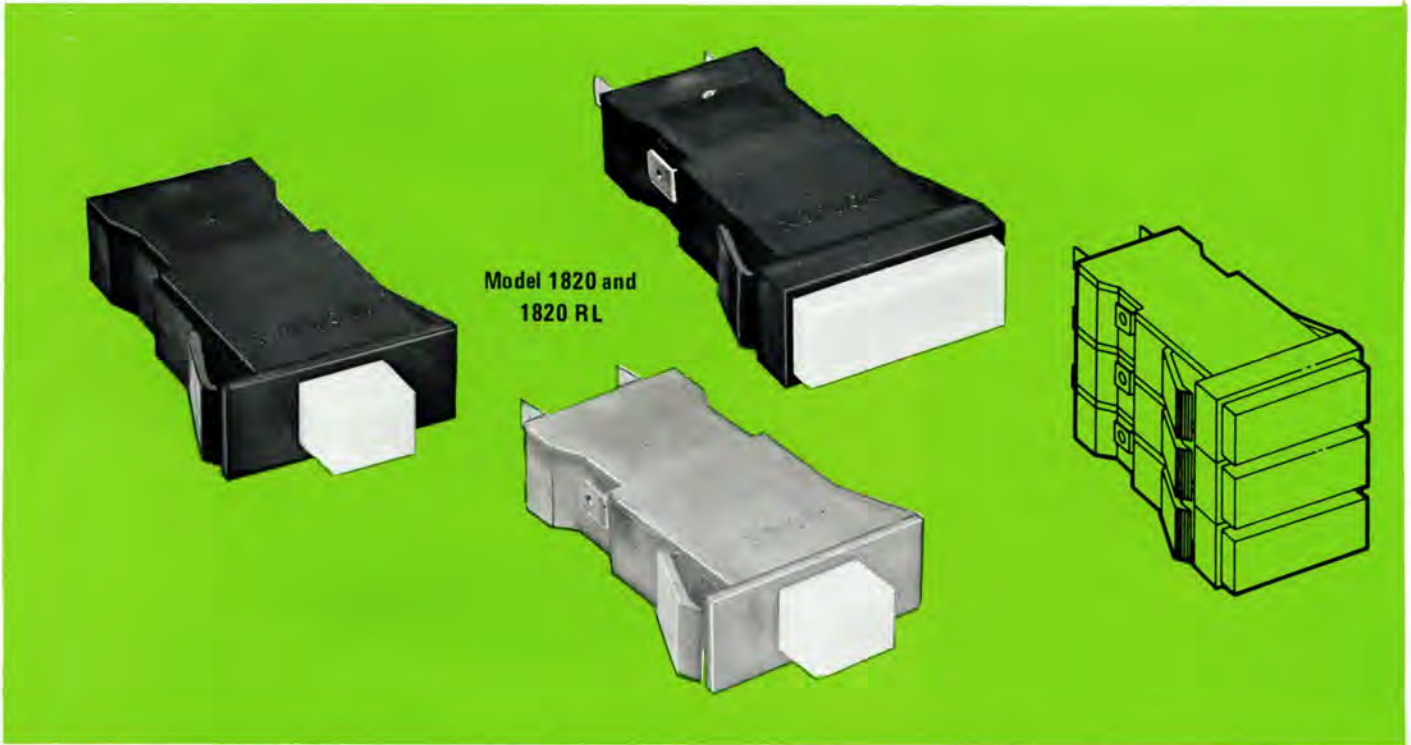

Model 1820 and 1820 RL

Tremendous versatility and almost limitless design possibilities are offered by the model 1820 lighted push button switches.

These SPST or SPDT switches may be used individually or stacked as multiple units, and can be used as a pilot light indicator without switching action or as a switch without the light . . . they are low in cost.

Applications range from use in test equipment to copy machines, office equipment, computers, peripheral equipment, vending machines, home entertainment units, appliances, conveyor systems, alarm systems, broadcast equipment, air pollution recording devices, medical electronics, pleasure boats, etc.

The 1820 RL (series 21-50/60) model has a removable lamp, but a fixed lamp is assembled in the 1820 (series 01-50/60). Both are UL and CSA rated at 2 or 9 amps at 125VAC, and the 1820 also at 6 amps at 125VAC and 4½ amps at 250VAC. Incandescent lamps of 6, 12, 14, or 28VAC ratings are

available. Neon glow lamps for 250VAC also are offered for the 1820 fixed-lamp. Actions for SPST or SPDT may be specified, including light-without-switch and switch-without-light.

Snap-lock molded mounting ears on the nylon housing permit easy insertion and removal in pre-cut panel openings. The locking ears permit a friction-holding assembly up to a 1-inch deep opening.

A choice of six colors can be specified for the housing. Buttons are available in identical or other colors to the housing in a square or rectangular shape and can be hot-stamped as specified. Also available are bezels of chrome, black oxide, or brass plate.

SPECIFICATIONS

Series 01-50/60 Series 21-50/60

Models: 1820, 1820RL

Switch action: SPST, SPDT, push-on/push-off, push-push (SPDT), momentary on or off, light-without-switch, switch-without-light, UL and CSA listed.

Switch rating: 2, 9 amps, 125VAC. Model 1820 also 6 amps, 125 VAC; 4½ amps, 250VAC.

Switch light: 6, 12 (except 1820), 14, 28VAC incandescent; 125 or 250VAC neon (1820).

Terminal size: 3/16 x .020-in. male spade.

Mounting method: Snap-lock with integrally molded mounting ears, removable.

Panel opening: .500 x 1.200 ins.

Panel thickness: .070-in. snap-lock minimum, friction fit to 1-in. maximum

Colors: Housing and bezel — amber, black, blue, green, red, white; buttons — amber, black, blue, brown, green, grey, orange, red, yellow, white; bezel — chrome, black oxide, or brass plate.

Button stamping: White on grey, red, blue, green, brown, and black; black on amber, yellow, white, and orange.

(For further specifications and details see Molex Catalog M300: SWITCHES.)

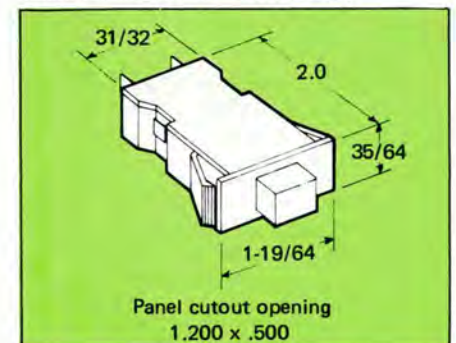



MODEL 1175 LIGHTED PUSH BUTTON SWITCHES

Series 01-10/20 Series 01-80

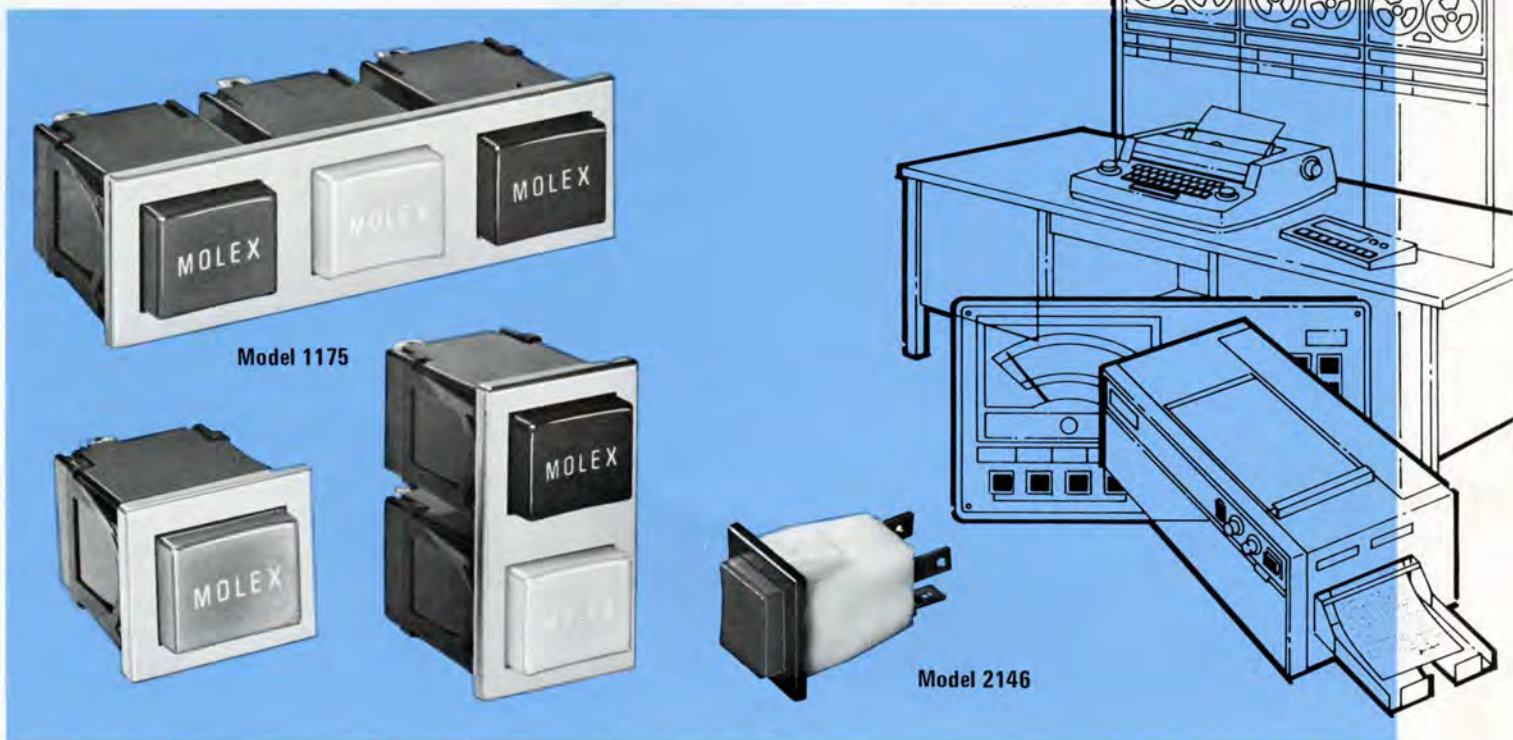

These model lighted switches add functional beauty to hundreds of products in the computer, home entertainment, business machine, appliance, vending and instrumentation industries.

They provide limitless variations for a user to tailor the switch to his specific needs. Series 01-80 (model 2146) is constructed with a dust-free nylon housing.

They are engineered for practical consumer use. Both are UL and CSA rated at 2 or 8½ amps at 125 VAC and 4 amps at 250VAC. The SPST action is available with push-on/push-off, momentary normally open or momentary normally closed. Switches can be clustered as multiple units and have optional mounting for fast, easy front panel insertion into cutouts.

A standard 125 VAC neon bulb illuminates the button. Also available are 6, 14, 28 VAC incandescent and 250 VAC neon bulbs. Either model may be used as a pilot light without the switch, or a switch without the light.

Mar-resistant nylon buttons are available in various colors, and can be hot-stamped with vertical or horizontal legends. Bezels also may be obtained in chrome, brass plate, or black oxide. The phenolic molded housing is made only in black for the 1175 (series 01-10/20).

Switch terminals are standard 1/4-inch male spade type, but can be ordered optionally with 18-gauge wire leads.

SPECIFICATIONS

Series 01-10/20 Series 01-80

Models: 1175, 2146

Switch action: SPST, push-on/push-off, or momentary on or off, light without switch, switch without light.

Switch rating: 2 amps or 8-1/2 amps at 125VAC; 4 amps at 250VAC; UL and CSA listed.

Switch light: 6, 14, 28VAC incandescent; 125 and 250VAC neon.

Terminal size: 1/4 in. male spade, optional 18-gauge wire leads.

Mounting method: Optional standard or positive snap-lock panel mounting.

Panel opening: .915 x 1.115 ins. for single unit.

Panel thickness: .031- to .171-in. range depending on clip.

Colors: Housing — black (1175), white nylon (2146); buttons — amber, black, blue, brown, green, grey, orange, red, yellow, white; bezel — chrome, black oxide, or brass plate.

Button stamping: White on grey, red, blue, green, brown, and black; black on amber, yellow, white, and orange.

(For further specifications and details see Molex Catalog M300: SWITCHES.)

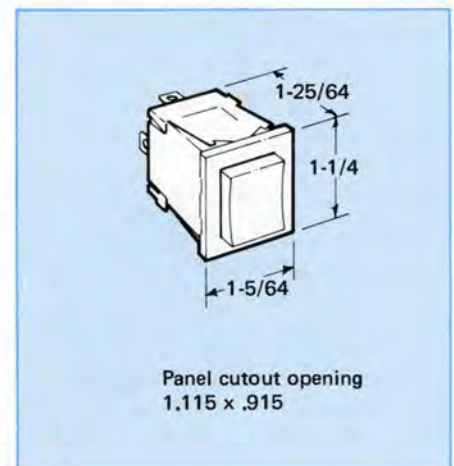



Switches SPECIAL PURPOSE SWITCHES

Series 01-01 Series 01-30/40 Series 01-70 Series 01-90/91/92/93



A unique switch designed by Molex specifically for a record changer; series 01-70, model 1500 demonstrates Molex design and engineering capabilities. This unit replaced many individual parts and provided a complete assembly that saves production time and money. Its molded mounting ears provide fast, single push assembly and its staked pin terminals double as external power connections and internal switch contacts.

SPECIFICATIONS

Series 01-70

Model: 1500.

Switch action: On/off.

Switch rating: 3 amps at 115VAC inductive load, UL and CSA listed.

Terminal size: .093-in. dia.

Mounting method: Integrally molded ears for snap-lock mounting.

Panel thickness: .062 ins.

Molex special purpose switches include combination push button with receptacle; momentary normally on or off rocker type; and on-off record changer.

The series 01-01 push-button switch combines a mounted receptacle with a push-on/push-off switch. It is available with an optional fluorescent light starter. This model 1151 is used extensively in bathroom medicine cabinets, ranges, and similar appliances.

SPECIFICATIONS

Series 01-01

Model: 1151.

Switch action: Push-on/push-off, optional fluorescent light starter.

Switch rating: 2 amps; receptacle 15 amps; starter for 40W fluorescent light at 125VAC; UL and CSA listed.

Terminal size: Wire leads attached, 14- and 18-gauge insulated.

Mounting method: Spring clip, snap-lock panel mount.

Panel opening: .929/.921 x 1.900/1.880 ins.

Panel thickness: .031 to .062 ins.

Colors: Housing and button — black, grey, white, brown, medium grey.

Model 1139 in the series 01-30/40 provides a combination of one or two push-on/push-off switches and a grounded receptacle. One switch can be used as a fluorescent starter and an on-off switch. Many combinations of switch action and internal connections are available.

SPECIFICATIONS

Series 01-30/40

Model: 1139.

Switch action: Push-on/push-off, single or double switch, optional fluorescent starter.

Switch rating: 2 amps; receptacle 15 amps; starter for 40W fluorescent light at 125VAC; UL and CSA listed.

Terminal size: 1/4-in. male spade with 16-gauge grounded lead and ring or pressure wire.

Mounting method: Optional standard for front-panel mounting, or clips for positive locking.

Panel opening: .985 x 2.435/2.460-in. range depending on clip.

Panel thickness: .020 to .090 ins.

Button stamping: White on black and grey; black on medium grey, white, and brown.

Colors: Housing — black; bezel — black or chrome; buttons — black, grey, medium grey, white, brown.

Among the newer switches is the series 01-90/91/92/93 model 1977 rocker type that provides for momentary on or off switching. The model 1977 was developed for use as a refrigerator light switch. It can be adapted for automatic lighting of equipment cabinets, closets, garages, as a safety switch, a treadle switch, for activating alarm systems, and similar uses. It is rated for 500,000 operating cycles with a 150W incandescent load.

SPECIFICATIONS

Series 01-90/91/92/93

Model: 1977.

Switch action: Momentary on or off.

Switch rating: 125 and 250VAC, UL listed.

Terminals: Silver button contacts.

Mounting method: Integrally molded ears for front entry snap-lock mounting.

Panel opening: 1.080 x .410 ins. or 1.080 x .900 ins. with optional cover flanges 19/32 x 1-13/64 ins., or 1 x 1-13/64.

Panel thickness: 3/32-in. thick maximum.

Colors: White.

(For further specifications and details, see Molex Catalog M300: SWITCHES.)



Tooling CRIMPING AND ASSEMBLY HAND TOOLS

Series 11-01/02/03



Series 11-01

Crimping is one of the most important steps in connector performance and Molex offers a number of ways to make reliable, strong and durable terminal/lead connections.

Prototype or repair work and small production runs are best handled with the simple but rugged hand tools developed by Molex. The series 11-01 models are supplied with dies for precise crimping of specified terminals. These hand-crimping tools include a ratchet assembly that facilitates operation.

Terminal extractors available for all Molex terminals are part of the hand tool line. Plunger types in separate models of series 11-03 are available for automatic extraction of .093- or .062-inch terminals.

For the .062-inch diameter and smaller terminals, special insertion equipment can be obtained. Two models of the series 11-02 are available.



Series 11-03



Series 11-02



Series 11-03



Series 11-02



Tooling

ASSEMBLY AND AUTOMATIC CRIMPING MACHINES

Series 11-05 Series 11-20 CS-9

Terminals assembled in PC board with Molex model 11-20-0001 vibration equipment, at the rate of 300 per minute, ready for soldering.



1. Place the PC board under the template of the Molex vibrator.



2. Sprinkle terminals over template.



3. Start vibrator.



4. Empty excess terminals from template into hopper.



5. Remove template with PC board.



6. Insert template and PC board into air press for staking.

Semi- and automatic machines for crimping terminals to leads assure strong, reliable connections.

The Molex bench press (model 11-05-0001) is designed specifically for fast, precision crimping operations. The press is fed from reels of chain-linked terminals and crimps terminals to leads at a rate of up to 3,000 per hour. The Molex bench press can easily be adjusted for crimping either male or female terminals. Bench presses may be

leased, purchased, or obtained through a lease-purchase basis.

Artos high-speed presses (models CS-9ST, CS-9AT) automatically cut, strip and crimp with utmost reliability.

The CS-9ST can be equipped with a double crimping head. It cuts, strips, and crimps 8,000 single wires per hour. The CS-9AT cuts, strips and crimps terminals at each end of a lead wire at a rate of 4,000

wires per hour. Artos machines may be obtained on a lease, purchase, or on a lease-purchase basis.

The Molex vibrator assembly equipment (model 11-20-0001) is especially advantageous when large numbers of PC terminals require board staking. Using a template as a guide, specified terminals can be placed on a board in any desired position at a rate of up to 300 per minute.

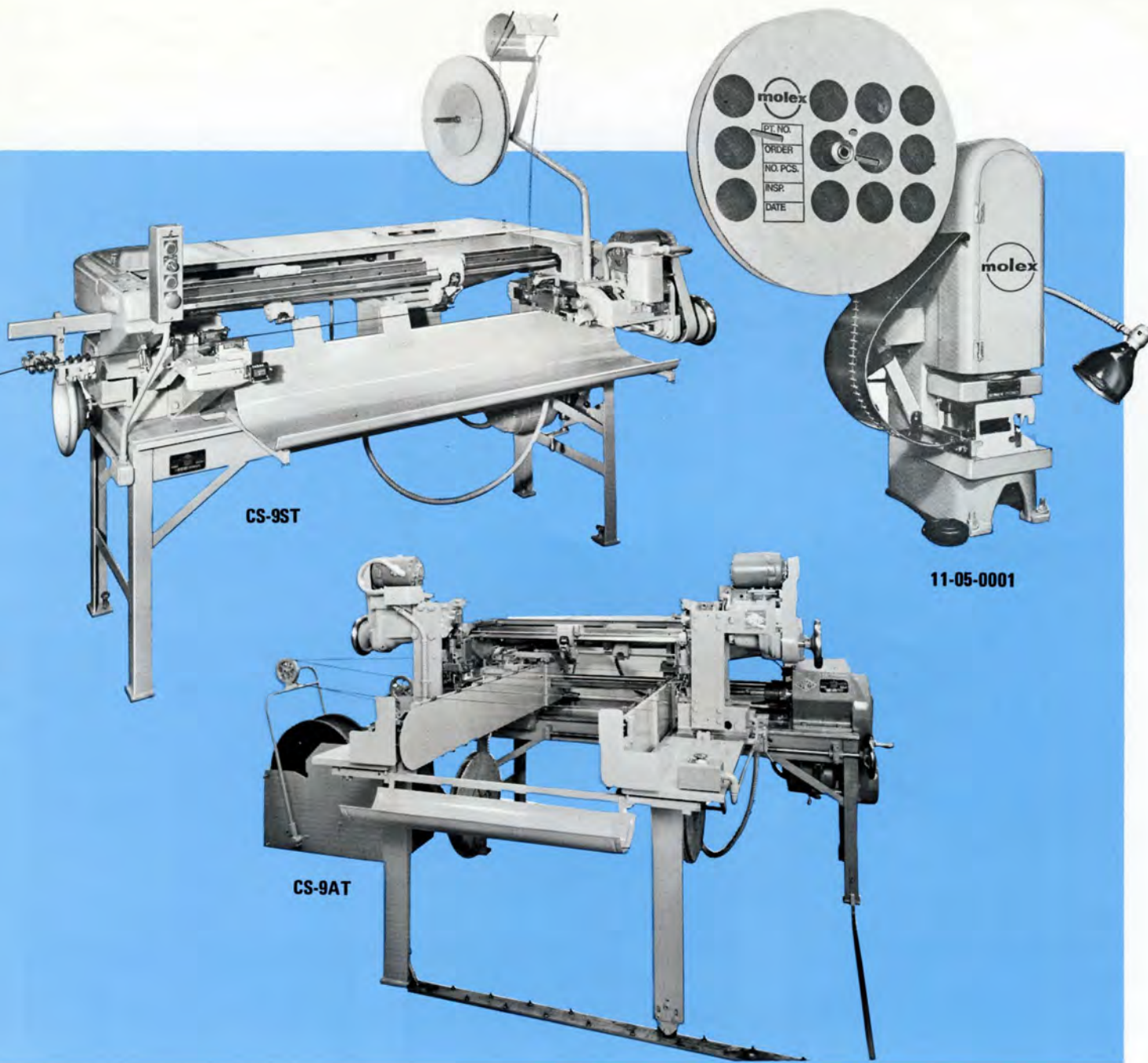

CS-9ST

11-05-0001

CS-9AT

SPECIFICATIONS

Series 11-05-0001

Model: 11-05-0001

Operation: Chain-link terminal crimping, semi-automatic, electric powered.

Terminal type: Crimp.

Wire sizes processed: 10- through 30-gauge.

Assembly rate: Up to 3,000 per hour

Bench space: 18 x 28 ins.

CS-9

Models: CS-9AT, CS-9ST

Operation: Automatically cuts and strips leads, crimps chain-linked terminals, elec-

tric powered. (CS-9AT also crimps loose terminals.)

Terminal type: Crimp.

Wire sizes processed: 4- through 24-gauge, insulated.

Lead lengths cut: 7-1/2 to 100 ins. (CS-9AT), 4 to 100 ins. (CS-9ST).

Lengths stripped: 3/16 through 1-1/2 ins., two ends (CS-9AT); 3/16 through 3/4 ins., one end (CS-9ST).

Assembly rate: CS-9AT - 24- through 4-gauge: 7-1/2- through 50-in. lengths, 3,600 to 4,000 per hour; 24- through 12-gauge: 50- through 100-in. lengths, 1,800 to 2,000 per hour.

CS-9ST - 24- through 4-gauge: 4- through 50-in. lengths, 3,600 to 4,000 per hour; 24- through 12-gauge: 50- through 100-in. lengths, 1,800 to 3,000 per hour.

Floor space: CS-9AT - 89-1/2 x 91-1/2 ins.
CS-9ST - 49 x 88 ins.

Series 11-20-0001

Model: 1875.

Operation: PC terminal vibrator assembly, electric powered.

Terminal type: Soldercon, Konektcon, similar staking types.

Assembly rate: Up to 300 per minute.

Bench space: 22 x 22 ins.

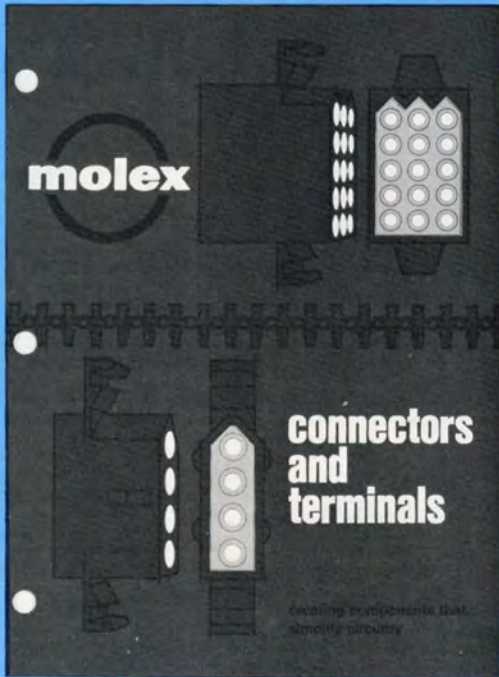

Catalog M200: Connectors and Terminals



Catalog M300: Switches

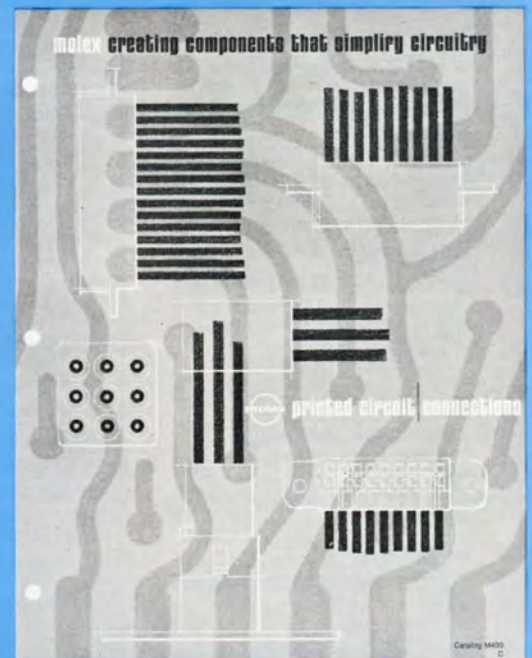

Catalog M400: Printed Circuit Connections

MOLEX products shown in this catalog are detailed with design drawings, engineering, and performance specifications in three technical catalogs. They may be obtained on request by:

- Using the information reply card enclosed in this catalog to order a copy of any or all of these catalogs;
- Contacting your area technical sales representative. Locations of these representatives are listed on the inside back cover; or
- Direct contact with MOLEX INCORPORATED, 2222 Wellington Court, Lisle, Illinois 60532. Telephone (312) 969-4550, TWX 910-695-3533.



Technical Sales Representatives throughout the world



UNITED STATES
MOLEX INCORPORATED
INTERNATIONAL DIVISION
 5224 Katrine Ave.
 Downers Grove, Illinois 60515
 Phone: 312-852-8400
 TWX 910/695-3533
 Telex No. 72-1540

AUSTRALIA
UTILUX PTY. LIMITED
 14 Commercial Road
 Kingsgrove, N. S.W., 2208
 Australia
 Phone: 50 0312

BELGIUM
ETS. CLOFIS S.P.R.L.
 Steenweg Brussel 539
 Notre-Dame Au Bois
 B-1900 Overijse, Belgium
 Phone: 02/57.18.05

CANADA
HENRY DAYMOND SALES,
LTD.
 262 Kerr Street
 Oakville, Ont., Canada
 Phone: (416) 844-6721

DENMARK
HANS FOLSGAARD
AGENTUR A-S
 Amalievej 20
 DK 1875
 Copenhagen, Denmark
 Phone: (01) 31 22 77

FRANCE
C.E.R.E.L. S.A.
 14-16 Rue de Lilas
 F-75 Paris 19E France
 Phone: 202-67-20

HOLLAND
N. V. Elspec
 Tetteroweweg 8-10
 Overveen
 Holland
 Phone: 023-255050

IRELAND
ATRONICS
 7 Lower Doreset Street
 Dublin 2, Ireland
 Phone: 48408

ISRAEL
GIVEON AGENCIES
 105 Hahashmonaim Street
 Tel-Aviv 67011
 Israel
 Phone: 266-122

ITALY
INTERTECNICA S.R.L.
 20144 Milano
 Via elba, 10
 Italy
 Phone: 46.97.241/2/3/4/5

JAPAN
MOLEX-SHOWA CO., LTD.
 No. 4, Kochi 322
 Shimosoyagi, Yamato-Shi
 Kanagawa-Ken, 242, Japan
 Phone: 0462-61-4500 & 4501

MEXICO
TELESISTEMAS e
INSTRUMENTACION S.A.
de C.V.
 Quetzalcoatl No. 10 Bix
 Col. Tlaxpana
 Mexico 17, D.F.
 Phone: 535-43-82

NEW ZEALAND
TERMINAL DISTRIBUTORS
LIMITED
 23 Edinburgh Street
 Newton
 Auckland, New Zealand
 Phone: 361-788

NORWAY
H. C. A. Melbye A/S
 Sandakerveien 104B
 Postboks 42, Grefsen
 Oslo 4, Norway
 Phone: 21 37 55

PUERTO RICO
E. FRANCESCHINI
ASSOCIATES
 187 Jose Padin St.
 Hato Rey, P.R. 00918
 Phone: 722-1291

SOUTH AFRICA
TECHNIX (PTY) LIMITED
 P.O. Box 10736
 Johannesburg, South Africa
 Phone: 35-7991

SPAIN
ELETRONICA INDUSTRIAL
COMERCIALIZADA
FASTRONIX, S.A. (ELICO)
 Constanca, 43
 Madrid 2, Spain
 Phone: 415 66 54

SWEDEN
ELKAB ELEKTRISKA
KABLAR AB
 Akers Runo
 Post Nummer 180 20
 Sweden
 Phone: 0764-201 10

SWITZERLAND
ERNST M. EGLI
INGENIEURBUREAU AG
 CH-8053 Zurich
 Witikonstrasse 295
 Switzerland
 Phone: (051) 53-38-11

UNITED KINGDOM
MOLEX INTERNATIONAL
 14 Yeading Lane, Hayes
 Middlesex, England
 Phone: (01) 561-0066

WEST GERMANY
ALFRED NEYE-
ENETECHNIK-GmbH
 2085 Quickborn - Hamburg
 Schillerstrabe 14
 West Germany
 Phone: 04106/612-1



Regional Sales
Offices
Lisle, Illinois

Eastern Region (312) 852-6600
Central Region (312) 852-6610
Midwestern Region (312) 852-6605
Western Region (312) 852-6630

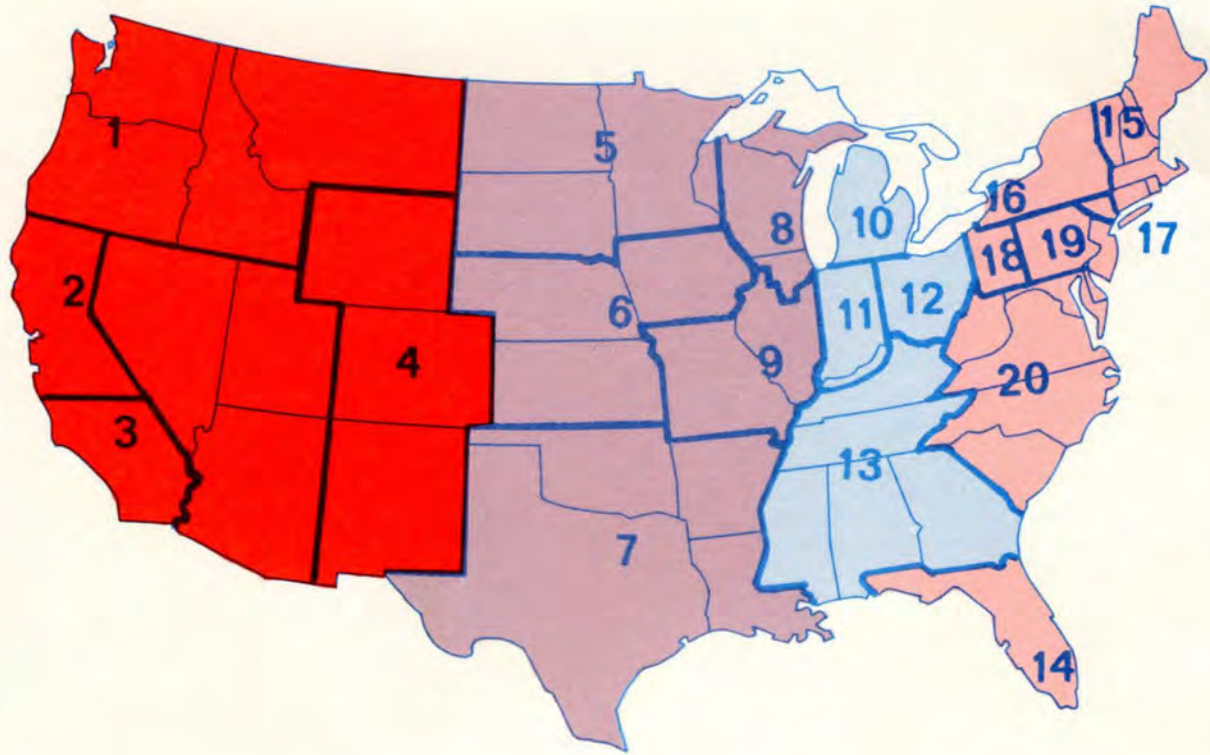

1. HENRY PAULMAN SALES
P.O. Box 875
Bellevue, Washington 98009
(206) 827-2421
Henry Paulman

2. JOHNSON & ASSOCIATES
2160 Prospect
Menlo Park, Calif. 94025
(415) 854-3550
Larry Johnson

3. R. H. McDONALD & ASSOCIATES
1323 Lincoln Boulevard
Santa Monica, Calif. 90401
(213) 393-9237
Russ McDonald,
Charles McLaughlin

4. I. W. STRONG & ASSOCIATES
635 Canosa Court
Denver, Colo. 80204
(303) 292-6900
Woody Strong, Ted Strong,
LeRoy (Bud) Knopfle

5. ED MELIUS & ASSOCIATES, INC.
1301 East 79th Street
Minneapolis, Minn. 55420
(612) 854-4270
Ed Melius, Ron Berthe,
Darrel McGillis

6. PALATINE ENGINEERING SALES, INC.
7520 West 63rd Street
Suite 10
Overland Park, Kans. 66202
(913) 262-5643
Frank McLean, John Schroy,
Carl Morgan, Marty Taraski

PALATINE ENGINEERING SALES, INC.
1722 North Terry Lane
Andover, Kans. 67002
(316) 683-7512
Richard Loosen

PALATINE ENGINEERING SALES, INC.
720 Third Avenue, S.E.
Cedar Rapids, Iowa 52401
(319) 365-8071
David Ott

7. STASCO
13310 Spring Grove Avenue
Dallas, Tex. 75240
(214) 239-5054
Bob Stastny

8. E. S. HEALY & ASSOCIATES
225 Warwick Lane
Crystal Lake, Ill. 60014
(815) 459-4386
Ed Healy, Sr., Ed Healy, Jr.,
Barry Fues, John Walsh

9. PALMER STILL & ASSOCIATES
9415 Old Bonhomme Road
St. Louis, Mo. 63132
(314) 993-2077
Palmer Still, Frank Manczuk

10. HAMPTON, ASKIN & ASSOC., INC.
205 W. Main Street
Benton Harbor, Mich. 49022
(616) 925-0341
Ike Hampton
Barney Askin

D. D. DOUGLASS & ASSOCIATES (Chrysler)
29563 Northwestern Hwy.
Suite 208
Southfield, Mich. 48075
(313) 352-7180

11. DALE A. MILLER & ASSOCIATES
P.O. Box 9
124 East Main
Crawfordsville, Ind. 47933
(317) 362-6348
Dale Miller, Doug Thomson,
Bob Greim, Kelly Howell

12. RALPH MECKLING ASSOCIATES
1575 Marion Avenue
Mansfield, Ohio 44906
(419) 529-3225
Ralph E. Meckling,
Harold J. Kieffer

13. PEIRSON, DEAKINS & MCGINNESS, INC.
3806 Tennessee Avenue
Chattanooga, Tenn. 37409
(615) 821-4501
Joe McGinness, Sr.,
Joe McGinness, Jr.,
Lynn Deakins

14. WMM ASSOCIATES, INC.
Hulmac Bldg., Suite 115
3118 Gulf to Bay Blvd.
Clearwater, Fla. 33515
(815) 726-8871
Fran (R. F.) Willett
WMM ASSOCIATES, INC.
1628 East Atlantic Blvd.
Pompano Beach, Fla. 33060
(305) 943-3091
Lee May, Russ Redhouse

WMM ASSOCIATES, INC.
515 Tivoli Court
Altamonte Springs,
Fla. 32701
(305) 831-4645
15. SALES ENGINEERING COMPANY
113 Commonwealth Avenue
West Concord, Mass. 01742
(617) 369-3943
Oscar Kress, Steve Curran,
Bill Allen, Jay Anderson,
Andy Terenzi, Norm Kraft,
Jack Grady

16. L-MAR ASSOCIATES
285 Mount Read Blvd.
P.O. Box 7945 Lyell Station
Rochester, New York 14606
(716) 328-5240
Edward L. Lepkowski,
David Kirby

17. P. SAFTLER ASSOCIATES, INC.
157 West 57th Street
New York, N. Y. 10019
(212) 247-3855
Arthur Saftler,
Norman Leeb,
Murray Toback

18. FLINN SALES & ASSOCIATES
11201 Frankstown Road
Pittsburgh, Penn. 15235
(412) 242-2442
Howard Flinn, Terry Flinn

19. EDWARD J. SWEENEY
District Sales Manager
MOLEX INCORPORATED
1304 Zachary
Roslyn, Pa. 19001
(215) 657-3107

20. BARNHILL & ASSOCIATES, INC.
Glen White
(headquarter office)
P.O. Box 1104
Lynchburg, Va. 24505
(703) 846-4624
Glen White
Garland Haynes

BARNHILL & ASSOCIATES, INC.
P.O. Box 251
Glen Arm, Md. 21057
(301) 252-5610
Bob Smith

BARNHILL & ASSOCIATES, INC.
6030 Bellow Street
Raleigh, N. C. 27609
(919) 787-5744
Lou Campbell

BARNHILL & ASSOCIATES, INC.
206 Chickasaw Drive
Johnson City, Tenn. 37601
(615) 928-0184
Bob Danzer



molex incorporated

2222 WELLINGTON CT.
LISLE, ILLINOIS 60532
312-969-4550
TWX 695-3553