

Distributed by:

**JAMECO**<sup>®</sup>  
ELECTRONICS

**www.Jameco.com ♦ 1-800-831-4242**

The content and copyrights of the attached  
material are the property of its owner.

Jameco Part Number 39909MOT



# MCM2708 MCM27A08

## 1024 X 8 ERASABLE PROM

The MCM2708/27A08 is an 8192-bit Erasable and Electrically Reprogrammable PROM designed for system debug usage and similar applications requiring nonvolatile memory that could be reprogrammed periodically. The transparent window on the package allows the memory content to be erased with ultraviolet light. Pin-for-pin mask-programmable ROMs are available for large volume production runs of systems initially using the MCM2708/27A08.

- Organized as 1024 Bytes of 8 Bits
- Static Operation
- Standard Power Supplies of +12 V, +5 V and -5 V
- Maximum Access Time = 300 ns – MCM27A08  
450 ns – MCM2708
- Low Power Dissipation
- Chip-Select Input for Memory Expansion
- TTL Compatible
- Three-State Outputs
- Pin Equivalent to the 2708
- Pin-for-Pin Compatible to MCM65308, MCM68308 or 2308 Mask-Programmable ROMs

## MOS

(N-CHANNEL, SILICON-GATE)

1024 X 8-BIT  
UV ERASABLE PROM

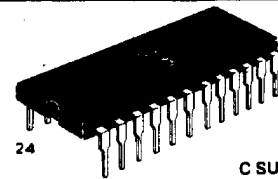

C SUFFIX  
FRIT-SEAL PACKAGE  
CASE 623A

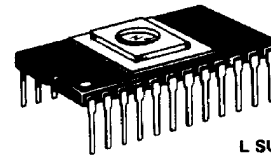

L SUFFIX  
CERAMIC PACKAGE  
CASE 716

### PIN CONNECTION DURING READ OR PROGRAM

Mode	Pin Number						
	9-11, 13-17	12	18	19	20	21	24
Read	D <sub>out</sub>	V <sub>SS</sub>	V <sub>SS</sub>	V <sub>DD</sub>	V <sub>IL</sub>	V <sub>BB</sub>	V <sub>CC</sub>
Program	D <sub>in</sub>	V <sub>SS</sub>	Pulsed V <sub>IHP</sub>	V <sub>DD</sub>	V <sub>IHW</sub>	V <sub>BB</sub>	V <sub>CC</sub>

### ABSOLUTE MAXIMUM RATINGS (1)

Rating	Value	Unit
Operating Temperature	0 to +70	°C
Storage Temperature	-65 to +125	°C
V <sub>DD</sub> with Respect to V <sub>BB</sub>	+20 to -0.3	V <sub>dc</sub>
V <sub>CC</sub> and V <sub>SS</sub> with Respect to V <sub>BB</sub>	+15 to -0.3	V <sub>dc</sub>
All Input or Output Voltages with Respect to V <sub>BB</sub> during Read	+15 to -0.3	V <sub>dc</sub>
CS/WE Input with Respect to V <sub>BB</sub> during Programming	+20 to -0.3	V <sub>dc</sub>
Program Input with Respect to V <sub>BB</sub>	+35 to -0.3	V <sub>dc</sub>
Power Dissipation	1.8	Watts

#### Note 1:

Permanent device damage may occur if ABSOLUTE MAXIMUM RATINGS are exceeded. Functional operation should be restricted to RECOMMENDED OPERATING CONDITIONS. Exposure to higher than recommended voltages for extended periods of time could affect device reliability.

### PIN ASSIGNMENT

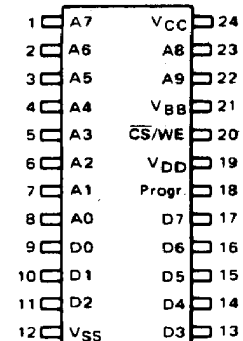

# MCM2708, MCM27A08

## BLOCK DIAGRAM

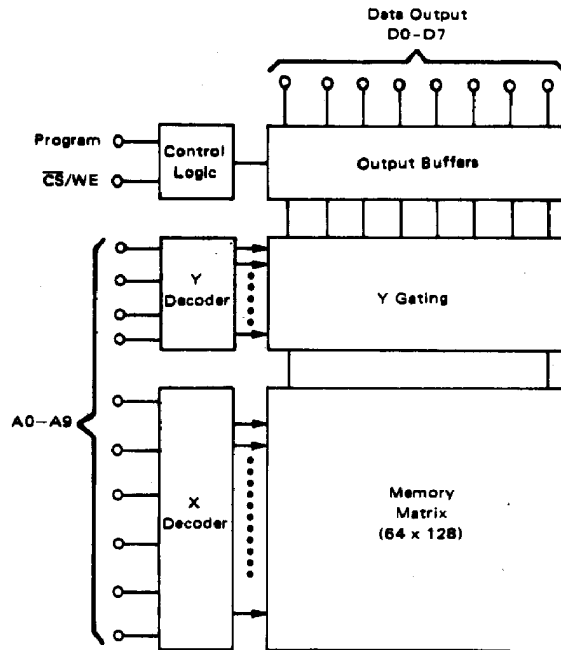

## DC READ OPERATING CONDITIONS AND CHARACTERISTICS (Full operating voltage and temperature range unless otherwise noted.)

### RECOMMENDED DC READ OPERATING CONDITIONS

Parameter	Symbol	Min	Nom	Max	Unit
Supply Voltage	$V_{CC}$	4.75	5.0	5.25	Vdc
	$V_{DD}$	11.4	12	12.6	Vdc
	$V_{BB}$	-5.25	-5.0	-4.75	Vdc
Input High Voltage	$V_{IH}$	3.0	—	$V_{CC} + 1.0$	Vdc
Input Low Voltage	$V_{IL}$	$V_{SS}$	—	0.65	Vdc

### READ OPERATION DC CHARACTERISTICS

Characteristic	Condition	Symbol	Min	Typ	Max	Unit
Address and CS Input Sink Current	$V_{in} = 5.25 \text{ V}$ or $V_{in} = V_{IL}$	$I_{in}$	—	1	10	$\mu\text{A}$
Output Leakage Current	$V_{out} = 5.25 \text{ V}$ , $\overline{\text{CS/WE}} = 5 \text{ V}$	$I_{LO}$	—	1	10	$\mu\text{A}$
$V_{DD}$ Supply Current	Worst-Case Supply Currents All Inputs High $\overline{\text{CS/WE}} = 5.0 \text{ V}$ , $T_A = 0^\circ\text{C}$	$I_{DD}$	—	50	65	mA
$V_{CC}$ Supply Current		$I_{CC}$	—	6	10	mA
$V_{BB}$ Supply Current		$I_{BB}$	—	30	45	mA
Output Low Voltage	$I_{OL} = 1.6 \text{ mA}$	$V_{OL}$	—	—	0.45	V
Output High Voltage	$I_{OH} = -100 \mu\text{A}$	$V_{OH1}$	3.7	—	—	V
Output High Voltage	$I_{OH} = -1.0 \text{ mA}$	$V_{OH2}$	2.4	—	—	V
Power Dissipation (Note 2)	$T_A = 70^\circ\text{C}$	$P_D$	—	—	800	mW

#### Note 2:

The total power dissipation is specified at 800 mW. It is not calculable by summing the various current ( $I_{DD}$ ,  $I_{CC}$ , and  $I_{BB}$ ) multiplied by their respective voltages, since current paths exist between the various power supplies and  $V_{SS}$ . The  $I_{DD}$ ,  $I_{CC}$ , and  $I_{BB}$  currents should be used to determine power supply capacity only.

$V_{BB}$  must be applied prior to  $V_{CC}$  and  $V_{DD}$ .  $V_{BB}$  must also be the last power supply switched off.

**AC READ OPERATING CONDITIONS AND CHARACTERISTICS**  
 (Full operating voltage and temperature range unless otherwise noted.)  
 (All timing with  $t_r = t_f = 20$  ns, Load per Note 3)

Characteristic	Symbol	MCM27A08			MCM2708			Unit
		Min	Typ	Max	Min	Typ	Max	
Address to Output Delay	$t_{AO}$	—	220	300	—	280	450	ns
Chip Select to Output Delay	$t_{CO}$	—	60	120	—	60	120	ns
Data Hold from Address	$t_{DHA}$	0	—	—	0	—	—	ns
Data Hold from Deselection	$t_{DHD}$	0	—	120	0	—	120	ns

**CAPACITANCE** (periodically sampled rather than 100% tested.)

Characteristic	Condition	Symbol	Typ	Max	Unit
Input Capacitance (f = 1.0 MHz)	$V_{in} = 0$ V, $T_A = 25^\circ$ C	$C_{in}$	4.0	6.0	pF
Output Capacitance (f = 1.0 MHz)	$V_{out} = 0$ V, $T_A = 25^\circ$ C	$C_{out}$	8.0	12	pF

**Note 3:**  
 Output Load = 1 TTL Gate and  $C_L = 100$  pF (Includes Jig Capacitance)  
 Timing Measurement Reference Levels: Inputs: 0.8 V and 2.8 V  
 Outputs: 0.8 V and 2.4 V

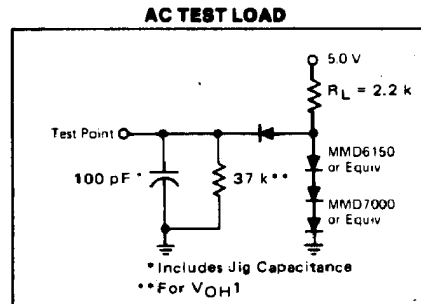

**READ OPERATION TIMING DIAGRAM**

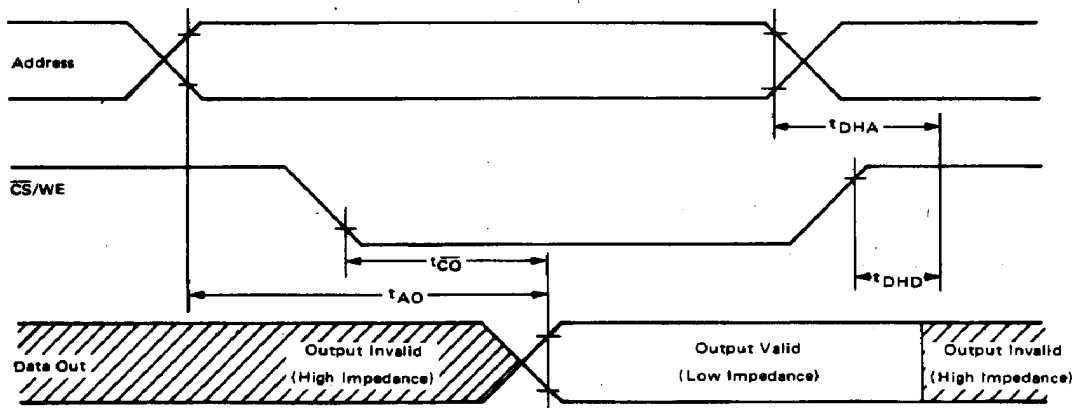

**DC PROGRAMMING CONDITIONS AND CHARACTERISTICS**  
(Full operating voltage and temperature range unless otherwise noted.)

**RECOMMENDED PROGRAMMING OPERATING CONDITIONS**

Parameter	Symbol	Min	Nom	Max	Unit
Supply Voltage	V <sub>CC</sub>	4.75	5.0	5.25	V <sub>dc</sub>
	V <sub>DD</sub>	11.4	12	12.6	V <sub>dc</sub>
	V <sub>BB</sub>	-5.25	-5.0	-4.75	V <sub>dc</sub>
Input High Voltage for All Addresses and Data	V <sub>IH</sub>	3.0	—	V <sub>CC</sub> + 1.0	V <sub>dc</sub>
Input Low Voltage (except Program)	V <sub>IL</sub>	V <sub>SS</sub>	—	0.65	V <sub>dc</sub>
CS/WE Input High Voltage (Note 4)	V <sub>IHW</sub>	11.4	12	12.6	V <sub>dc</sub>
Program Pulse Input High Voltage (Note 4)	V <sub>IHP</sub>	25	—	27	V <sub>dc</sub>
Program Pulse Input Low Voltage (Note 5)	V <sub>ILP</sub>	V <sub>SS</sub>	—	1.0	V <sub>dc</sub>

Note 4: Referenced to V<sub>SS</sub>.  
 Note 5: V<sub>IHP</sub> - V<sub>ILP</sub> = 25 V min.

**PROGRAMMING OPERATION DC CHARACTERISTICS**

Characteristic	Condition	Symbol	Min	Typ	Max	Unit
Address and CS/WE Input Sink Current	V <sub>in</sub> = 5.25 V	I <sub>LI</sub>	—	—	10	μ <sub>Adc</sub>
Program Pulse Source Current		I <sub>IPL</sub>	—	—	3.0	m <sub>Adc</sub>
Program Pulse Sink Current		I <sub>IPH</sub>	—	—	20	m <sub>Adc</sub>
V <sub>DD</sub> Supply Current	Worst-Case Supply Currents All Inputs High CS/WE = 5 V, T <sub>A</sub> = 0°C	I <sub>DD</sub>	—	50	65	m <sub>Adc</sub>
V <sub>CC</sub> Supply Current		I <sub>CC</sub>	—	6	10	m <sub>Adc</sub>
V <sub>BB</sub> Supply current		I <sub>BB</sub>	—	30	45	m <sub>Adc</sub>

**AC PROGRAMMING OPERATING CONDITIONS AND CHARACTERISTICS**  
(Full operating voltage and temperature unless otherwise noted.)

Characteristic	Symbol	Min	Max	Unit
Address Setup Time	t <sub>AS</sub>	10	—	μs
CS/WE Setup Time	t <sub>CSS</sub>	10	—	μs
Data Setup Time	t <sub>DS</sub>	10	—	μs
Address Hold Time	t <sub>AH</sub>	1.0	—	μs
CS/WE Hold Time	t <sub>CH</sub>	0.5	—	μs
Data Hold Time	t <sub>DH</sub>	1.0	—	μs
Chip Deselect to Output Float Delay	t <sub>DF</sub>	0	120	ns
Program to Read Delay	t <sub>DPR</sub>	—	10	μs
Program Pulse Width	t <sub>PW</sub>	0.1	1.0	ms
Program Pulse Rise Time	t <sub>PR</sub>	0.5	2.0	μs
Program Pulse Fall Time	t <sub>PF</sub>	0.5	2.0	μs

PROGRAMMING OPERATION TIMING DIAGRAM

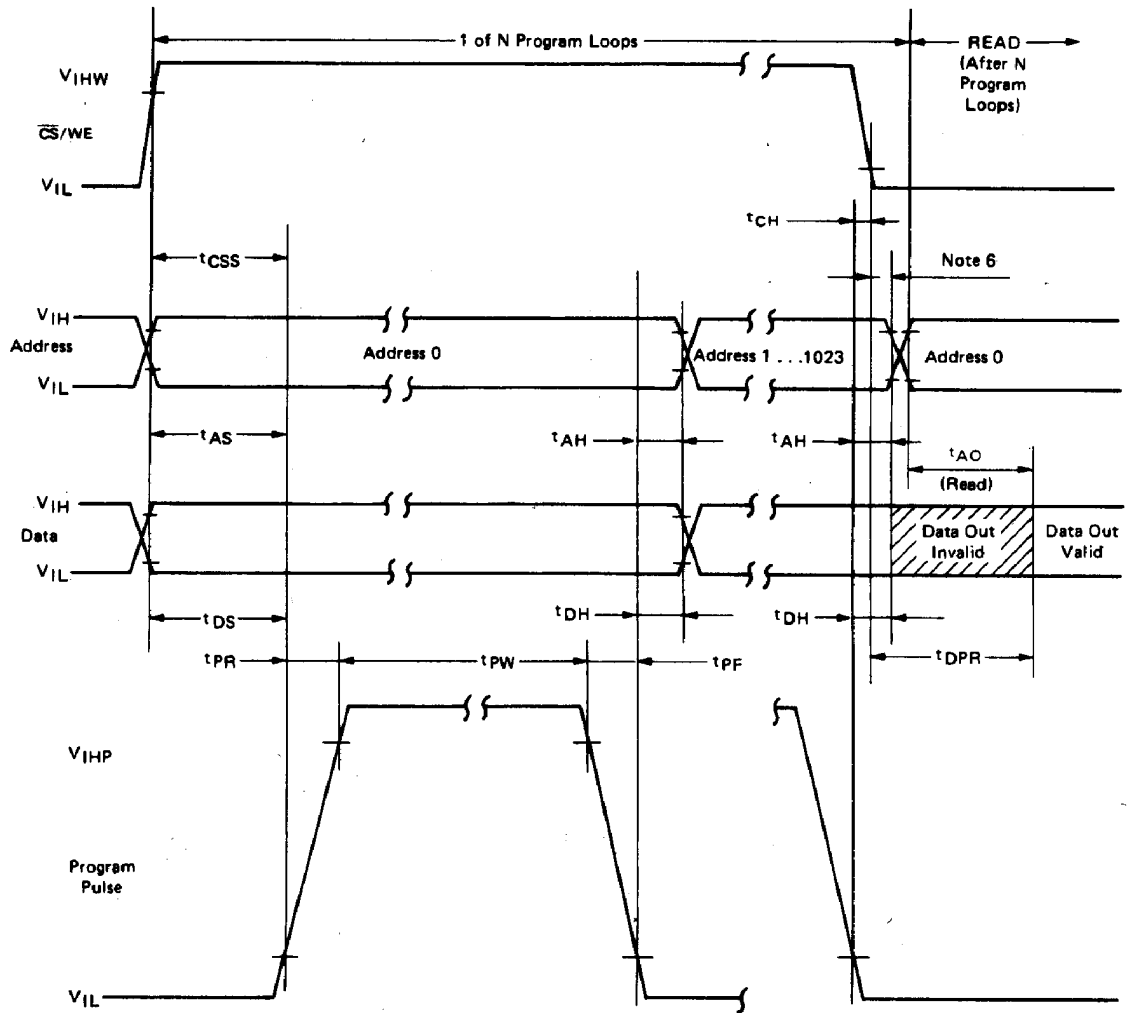

Note 6: The  $\overline{CS/WE}$  transition must occur after the Program Pulse transition and before the Address Transition.

Motorola reserves the right to make changes to any products herein to improve reliability, function or design. Motorola does not assume any liability arising out of the application or use of any product or circuit described herein; neither does it convey any license under its patent rights nor the rights of others.

## PROGRAMMING INSTRUCTIONS

After the completion of an ERASE operation, every bit in the device is in the "1" state (represented by Output High). Data are entered by programming zeros (Output Low) into the required bits. The words are addressed the same way as in the READ operation. A programmed "0" can only be changed to a "1" by ultra-violet light erasure.

To set the memory up for programming mode, the  $\overline{CS}/WE$  input (Pin 20) should be raised to +12 V. Programming data is entered in 8-bit words through the data output terminals (D0 to D7).

Logic levels for the data lines and addresses and the supply voltages ( $V_{CC}$ ,  $V_{DD}$ ,  $V_{BB}$ ) are the same as for the READ operation.

After address and data setup one program pulse per address is applied to the program input (Pin 18). A program loop is a full pass through all addresses. Total programming time,  $T_{Ptotal} = N \times t_{PW} \geq 100$  ms. The required number of program loops (N) is a function of the program pulse width ( $t_{PW}$ ), where:  $0.1 \text{ ms} \leq t_{PW} \leq 1.0 \text{ ms}$ ; correspondingly N is:  $100 \leq N \leq 1000$ . There must be N successive loops through all 1024 addresses. It is not permitted to apply more than one program pulse in succession to the same address (i.e., N program pulses to an address and then change to the next address to be programmed). At the end of a program sequence the  $\overline{CS}/WE$  falling edge transition must occur before the first address transition, when changing from a PROGRAM to a READ cycle. The program pin (Pin 18) should be pulled down to  $V_{ILP}$  with an active device, because this pin sources a small amount of current ( $I_{PL}$ ) when  $\overline{CS}/WE$  is at  $V_{IHW}$  (12 V) and the program pulse is at  $V_{ILP}$ .

### EXAMPLES FOR PROGRAMMING

Always use the  $T_{Ptotal} = N \times t_{PW} \geq 100$  ms relationship.

1. All 8192 bits should be programmed with a 0.2 ms program pulse width.

The minimum number of program loops:

$$N = \frac{T_{Ptotal}}{t_{PW}} = \frac{100 \text{ ms}}{0.2 \text{ ms}} = 500. \text{ One program loop}$$

consists of words 0 to 1023.

2. Words 0 to 200 and 300 to 700 are to be programmed. All other bits are "don't care". The program pulse width is 0.5 ms. The minimum number of program loops,  $N = \frac{100}{0.5} = 200$ . One program loop consists of words 0 to 1023. The data entered into the "don't care" bits should be all 1s.
3. Same requirements as example 2, but the EPROM is now to be updated to include data for words 850 to 880. The minimum number of program loops is the same as in the previous example,  $N = 200$ . One program loop consists of words 0 to 1023. The data entered into the "don't care" bits should be all 1s. Addresses 0 to 200 and 300 to 700 must be re-programmed with their original data pattern.

## ERASING INSTRUCTIONS

The MCM2708/27A08 can be erased by exposure to high intensity shortwave ultraviolet light, with a wavelength of 2537 Å. The recommended integrated dose (i.e., UV-intensity x exposure time) is 12.5 Ws/cm<sup>2</sup>. As an example, using the "Model 30-000" UV-Eraser (Turner Designs, Mountain View, CA94043) the ERASE-time is 30 minutes. The lamps should be used without shortwave filters and the MCM2708/27A08 should be positioned about one inch away from the UV-tubes.