

### Features

- **Maximum Input Clock Maximum Frequency Options**  
At  $V_{DD} = 5V$ 
  - CDP1802A, AC .....3.2MHz
  - CDP1802BC.....5.0MHz
- **Maximum Input Clock Maximum Frequency Options**  
At  $V_{DD} = 10V$ 
  - CDP1802A, AC .....6.4MHz
- **Minimum Instruction Fetch-Execute Times**  
At  $V_{DD} = 5V$ 
  - CDP1802A, AC ..... 5.0 $\mu$ s
  - CDP1802BC..... 3.2 $\mu$ s
- **Any Combination of Standard RAM and ROM Up to 65,536 Bytes**
- **8-Bit Parallel Organization With Bidirectional Data Bus and Multiplexed Address Bus**
- **16 x 16 Matrix of Registers for Use as Multiple Program Counters, Data Pointers, or Data Registers**
- **On-Chip DMA, Interrupt, and Flag Inputs**
- **Programmable Single-Bit Output Port**
- **91 Easy-to-Use Instructions**

### Description

The CDP1802 family of CMOS microprocessors are 8-bit register oriented central processing units (CPUs) designed for use as general purpose computing or control elements in a wide range of stored program systems or products.

The CDP1802 types include all of the circuits required for fetching, interpreting, and executing instructions which have been stored in standard types of memories. Extensive input/output (I/O) control features are also provided to facilitate system design.

The 1800 series architecture is designed with emphasis on the total microcomputer system as an integral entity so that systems having maximum flexibility and minimum cost can be realized. The 1800 series CPU also provides a synchronous interface to memories and external controllers for I/O devices, and minimizes the cost of interface controllers. Further, the I/O interface is capable of supporting devices operating in polled, interrupt driven, or direct memory access modes.

The CDP1802A and CDP1802AC have a maximum input clock frequency of 3.2MHz at  $V_{DD} = 5V$ . The CDP1802A and CDP1802AC are functionally identical. They differ in that the CDP1802A has a recommended operating voltage range of 4V to 10.5V, and the CDP1802AC a recommended operating voltage range of 4V to 6.5V.

The CDP1802BC is a higher speed version of the CDP1802AC, having a maximum input clock frequency of 5.0MHz at  $V_{DD} = 5V$ , and a recommended operating voltage range of 4V to 6.5V.

### Ordering Information

| PART NUMBER |             | TEMPERATURE RANGE | PACKAGE | PKG. NO. |
|-------------|-------------|-------------------|---------|----------|
| 5V - 3.2MHz | 5V - 5MHz   |                   |         |          |
| CDP1802ACE  | CDP1802BCE  | -40°C to +85°C    | PDIP    | E40.6    |
| CDP1802ACEX | CDP1802BCEX |                   | Burn-In | E40.6    |
| CDP1802ACQ  | CDP1802BCQ  | -40°C to +85°C    | PLCC    | N44.65   |
| CDP1802ACD  | -           | -40°C to +85°C    | SBDIP   | D40.6    |
| CDP1802ACDX | CDP1802BCDX |                   | Burn-In | D40.6    |



CDP1802A, CDP1802AC, CDP1802BC

Block Diagram

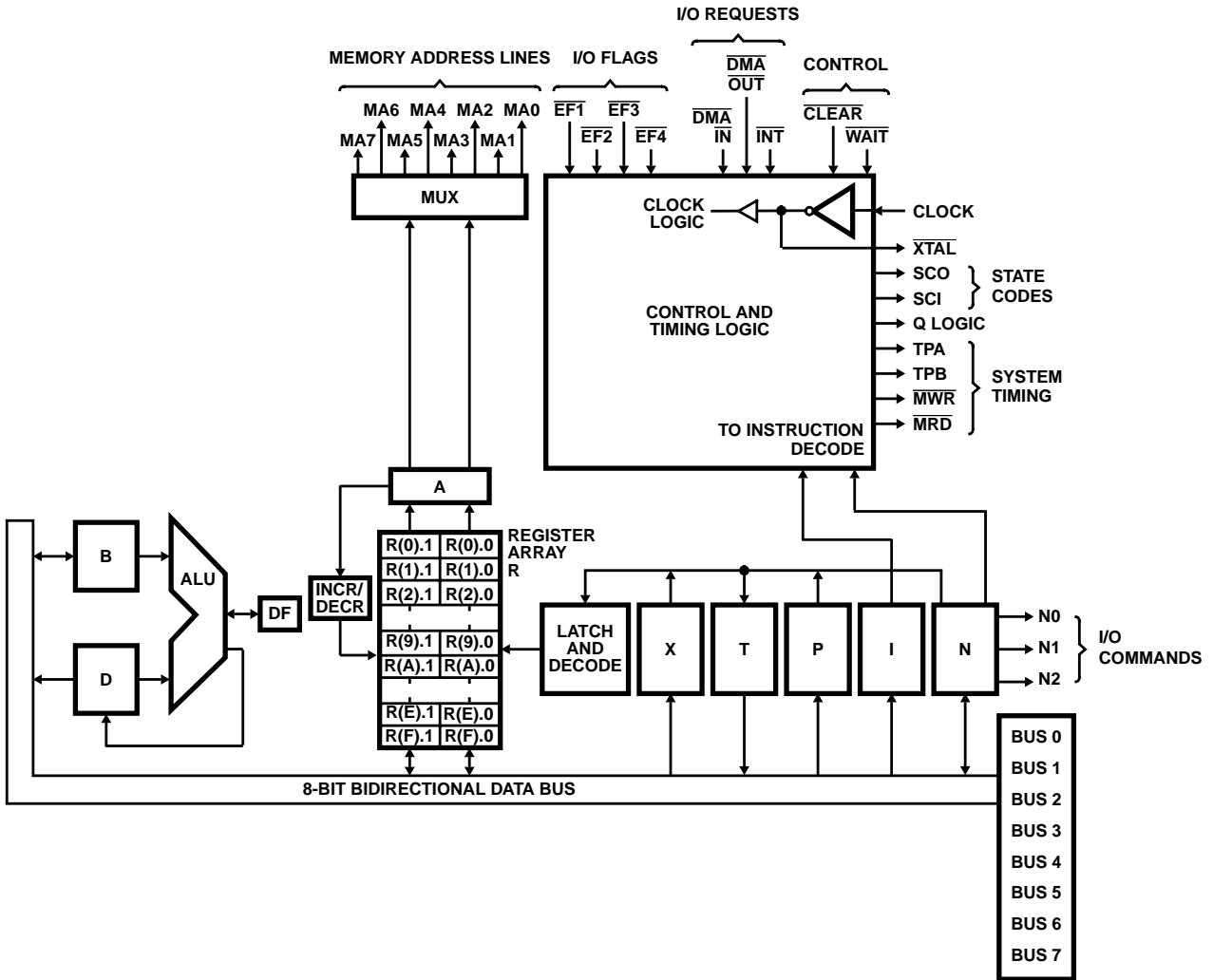

FIGURE 2.

## CDP1802A, CDP1802AC, CDP1802BC

### Absolute Maximum Ratings

DC Supply Voltage Range, ( $V_{DD}$ )  
 (All Voltages Referenced to  $V_{SS}$  Terminal)  
 CDP1802A..... -0.5V to +11V  
 CDP1802AC, CDP1802BC..... -0.5V to +7V  
 Input Voltage Range, All Inputs ..... -0.5V to  $V_{DD}$  +0.5V  
 DC Input Current, any One Input.....  $\pm 10$ mA

### Thermal Information

|                                      |                                 |                                 |
|--------------------------------------|---------------------------------|---------------------------------|
| Thermal Resistance (Typical, Note 4) | $\theta_{JA}$ ( $^{\circ}$ C/W) | $\theta_{JC}$ ( $^{\circ}$ C/W) |
| PDIP .....                           | 50                              | N/A                             |
| PLCC .....                           | 46                              | N/A                             |
| SBDIP .....                          | 55                              | 15                              |

Device Dissipation Per Output Transistor  
 $T_A$  = Full Package Temperature Range ..... 100mW  
 Operating Temperature Range ( $T_A$ )  
 Package Type D ..... -55 $^{\circ}$ C to +125 $^{\circ}$ C  
 Package Type E and Q ..... -40 $^{\circ}$ C to +85 $^{\circ}$ C  
 Storage Temperature Range ( $T_{STG}$ ) ..... -65 $^{\circ}$ C to +150 $^{\circ}$ C  
 Lead Temperature (During Soldering)  
 At distance 1/16  $\pm$  1/32 In. (1.59  $\pm$  0.79mm)  
 from case for 10s max..... +265 $^{\circ}$ C  
 Lead Tips Only ..... +300 $^{\circ}$ C

*CAUTION: Stresses above those listed in "Absolute Maximum Ratings" may cause permanent damage to the device. This is a stress only rating and operation of the device at these or any other conditions above those indicated in the operational sections of this specification is not implied.*

**Recommended Operating Conditions**  $T_A = -40^{\circ}$ C to +85 $^{\circ}$ C. For maximum reliability, operating conditions should be selected so that operation is always within the following ranges:

| PARAMETER   | TEST CONDITIONS             |                 | CDP1802A |          | CDP1802AC |          | CDP1802BC |          | UNITS    |
|---|-----------------------------|-----------------|----------|----------|-----------|----------|-----------|----------|----------|
|   | (NOTE 2)<br>$V_{CC}$<br>(V) | $V_{DD}$<br>(V) | MIN      | MAX      | MIN       | MAX      | MIN       | MAX      |          |
| DC Operating Voltage Range  | -                           | -               | 4        | 10.5     | 4         | 6.5      | 4         | 6.5      | V        |
| Input Voltage Range   | -                           | -               | $V_{SS}$ | $V_{DD}$ | $V_{SS}$  | $V_{DD}$ | $V_{SS}$  | $V_{DD}$ | V        |
| Maximum Clock Input Rise or Fall Time                                       | 4 to 6.5                    | 4 to 6.5        | -        | -        | -         | 1        | -         | 1        | $\mu$ s  |
|   | 4 to 10.5                   | 4 to 10.5       | -        | 1        | -         | -        | -         | -        | $\mu$ s  |
| Minimum Instruction Time (Note 3)   | 5                           | 5               | 5        | -        | 5         | -        | 3.2       | -        | $\mu$ s  |
|   | 5                           | 10              | 4        | -        | -         | -        | -         | -        | $\mu$ s  |
|   | 10                          | 10              | 2.5      | -        | -         | -        | -         | -        | $\mu$ s  |
| Maximum DMA Transfer Rate   | 5                           | 5               | -        | 400      | -         | 400      | -         | 667      | KBytes/s |
|   | 5                           | 10              | -        | 500      | -         | -        | -         | -        |          |
|   | 10                          | 10              | -        | 800      | -         | -        | -         | -        |          |
| Maximum Clock Input Frequency, $f_{CL}$ , Load Capacitance ( $C_L$ ) = 50pF | 5                           | 5               | DC       | 3.2      | DC        | 3.2      | DC        | 5        | MHz      |
|   | 5                           | 10              | DC       | 4        | -         | -        | -         | -        | MHz      |
|   | 10                          | 10              | DC       | 6.4      | -         | -        | -         | -        | MHz      |

**NOTES:**

1. Printed circuit board mount: 57mm x 57mm minimum area x 1.6mm thick G10 epoxy glass, or equivalent.
2.  $V_{CC}$  must never exceed  $V_{DD}$ .
3. Equals 2 machine cycles - one Fetch and one Execute operation for all instructions except Long Branch and Long Skip, which require 3 machine cycles - one Fetch and two Execute operations.
4.  $\theta_{JA}$  is measured with component mounted on an evaluation board in free air.

**CDP1802A, CDP1802AC, CDP1802BC**

**Static Electrical Specifications** at  $T_A = -40^{\circ}\text{C}$  to  $+85^{\circ}\text{C}$ , Except as Noted

| PARAMETER   | SYMBOL                | TEST CONDITIONS        |                 |                              | CDP1802A |                 |         | CDP1802AC,<br>CDP1802BC |                 |         | UNITS         |
|---|-----------------------|------------------------|-----------------|------------------------------|----------|-----------------|---------|-------------------------|-----------------|---------|---------------|
|   |                       | $V_{OUT}$<br>(V)       | $V_{IN}$<br>(V) | $V_{CC},$<br>$V_{DD}$<br>(V) | MIN      | (NOTE 1)<br>TYP | MAX     | MIN                     | (NOTE 1)<br>TYP | MAX     |               |
| Quiescent Device Current                                    | $I_{DD}$              | -                      | -               | 5                            | -        | 0.1             | 50      | -                       | 1               | 200     | $\mu\text{A}$ |
|   |                       | -                      | -               | 10                           | -        | 1               | 200     | -                       | -               | -       | $\mu\text{A}$ |
| Output Low Drive (Sink)<br>Current                          | $I_{OL}$              | 0.4                    | 0, 5            | 5                            | 1.1      | 2.2             | -       | 1.1                     | 2.2             | -       | mA            |
| (Except $\overline{\text{XTAL}}$ )                          |                       | 0.5                    | 0, 10           | 10                           | 2.2      | 4.4             | -       | -                       | -               | -       | mA            |
| $\overline{\text{XTAL}}$                                    |                       | 0.4                    | 5               | 5                            | 170      | 350             | -       | 170                     | 350             | -       | $\mu\text{A}$ |
| Output High Drive (Source)<br>Current                       | $I_{OH}$              | 4.6                    | 0, 5            | 5                            | -0.27    | -0.55           | -       | -0.27                   | -0.55           | -       | mA            |
| (Except $\overline{\text{XTAL}}$ )                          |                       | 9.5                    | 0, 10           | 10                           | -0.55    | -1.1            | -       | -                       | -               | -       | mA            |
| $\overline{\text{XTAL}}$                                    |                       | 4.6                    | 0               | 5                            | -125     | -250            | -       | -125                    | -250            | -       | $\mu\text{A}$ |
| Output Voltage<br>Low Level                                 | $V_{OL}$              | -                      | 0, 5            | 5                            | -        | 0               | 0.1     | -                       | 0               | 0.1     | V             |
|   |                       | -                      | 0, 10           | 10                           | -        | 0               | 0.1     | -                       | -               | -       | V             |
| Output Voltage<br>High Level                                | $V_{OH}$              | -                      | 0, 5            | 5                            | 4.9      | 5               | -       | 4.9                     | 5               | -       | V             |
|   |                       | -                      | 0, 10           | 10                           | 9.9      | 10              | -       | -                       | -               | -       | V             |
| Input Low Voltage   | $V_{IL}$              | 0.5, 4.5               | -               | 5                            | -        | -               | 1.5     | -                       | -               | 1.5     | V             |
|   |                       | 0.5, 4.5               | -               | 5, 10                        | -        | -               | 1       | -                       | -               | -       | V             |
|   |                       | 1, 9                   | -               | 10                           | -        | -               | 3       | -                       | -               | -       | V             |
| Input High Voltage  | $V_{IH}$              | 0.5, 4.5               | -               | 5                            | 3.5      | -               | -       | 3.5                     | -               | -       | V             |
|   |                       | 0.5, 4.5               | -               | 5, 10                        | 4        | -               | -       | -                       | -               | -       | V             |
|   |                       | 1, 9                   | -               | 10                           | 7        | -               | -       | -                       | -               | -       | V             |
| CLEAR Input Voltage   | $V_H$                 | -                      | -               | 5                            | 0.4      | 0.5             | -       | 0.4                     | 0.5             | -       | V             |
| Schmitt Hysteresis  |                       | -                      | -               | 5, 10                        | 0.3      | 0.4             | -       | -                       | -               | -       | V             |
|   |                       | -                      | -               | 10                           | 1.5      | 2               | -       | -                       | -               | -       | V             |
| Input Leakage Current                                       | $I_{IN}$              | Any Input              | 0, 5            | 5                            | -        | $\pm 10^{-4}$   | $\pm 1$ | -                       | $\pm 10^{-4}$   | $\pm 1$ | $\mu\text{A}$ |
|   |                       |                        | 0, 10           | 10                           | -        | $\pm 10^{-4}$   | $\pm 1$ | -                       | -               | -       | $\mu\text{A}$ |
| Three-State Output Leakage<br>Current                       | $I_{OUT}$             | 0, 5                   | 0, 5            | 5                            | -        | $\pm 10^{-4}$   | $\pm 1$ | -                       | $\pm 10^{-4}$   | $\pm 1$ | $\mu\text{A}$ |
|   |                       | 0, 10                  | 0, 10           | 10                           | -        | $\pm 10^{-4}$   | $\pm 1$ | -                       | -               | -       | $\mu\text{A}$ |
| Operating Current<br>CDP1802A, AC<br>at $f = 3.2\text{MHz}$ | $I_{DDI}$<br>(Note 2) | -                      | -               | 5                            | -        | 2               | 4       | -                       | 2               | 4       | mA            |
| CDP1802BC<br>at $f = 5.0\text{MHz}$                         |                       | -                      | -               | 5                            | -        | -               | -       | -                       | 3               | 6       | mA            |
| Minimum Data Retention<br>Voltage                           | $V_{DR}$              | $V_{DD} = V_{DR}$      |                 |                              | -        | 2               | 2.4     | -                       | 2               | 2.4     | V             |
| Data Retention Current                                      | $I_{DR}$              | $V_{DD} = 2.4\text{V}$ |                 |                              | -        | 0.05            | -       | -                       | 0.5             | -       | $\mu\text{A}$ |

**CDP1802A, CDP1802AC, CDP1802BC**

**Static Electrical Specifications** at  $T_A = -40^{\circ}\text{C}$  to  $+85^{\circ}\text{C}$ , Except as Noted (Continued)

| PARAMETER          | SYMBOL    | TEST CONDITIONS |              |                      | CDP1802A |              |     | CDP1802AC, CDP1802BC |              |     | UNITS |
|--------------------|-----------|-----------------|--------------|----------------------|----------|--------------|-----|----------------------|--------------|-----|-------|
|                    |           | $V_{OUT}$ (V)   | $V_{IN}$ (V) | $V_{CC}, V_{DD}$ (V) | MIN      | (NOTE 1) TYP | MAX | MIN                  | (NOTE 1) TYP | MAX |       |
| Input Capacitance  | $C_{IN}$  |                 |              |                      | -        | 5            | 7.5 | -                    | 5            | 7.5 | pF    |
| Output Capacitance | $C_{OUT}$ |                 |              |                      | -        | 10           | 15  | -                    | 10           | 15  | pF    |

NOTES:

1. Typical values are for  $T_A = +25^{\circ}\text{C}$  and nominal  $V_{DD}$ .
2. Idle "00" at M(0000),  $C_L = 50\text{pF}$ .

**Dynamic Electrical Specifications**  $T_A = -40^{\circ}\text{C}$  to  $+85^{\circ}\text{C}$ ,  $C_L = 50\text{pF}$ ,  $V_{DD} \pm 5\%$ , Except as Noted

| PARAMETER                              | SYMBOL             | TEST CONDITIONS |              | CDP1802A, CDP1802AC |     | CDP1802BC    |     | UNITS |
|--|--------------------|-----------------|--------------|---------------------|-----|--------------|-----|-------|
|  |                    | $V_{CC}$ (V)    | $V_{DD}$ (V) | (NOTE 1) TYP        | MAX | (NOTE 1) TYP | MAX |       |
| <b>PROPAGATION DELAY TIMES</b>         |                    |                 |              |                     |     |              |     |       |
| Clock to TPA, TPB                      | $t_{PLH}, t_{PHL}$ | 5               | 5            | 200                 | 300 | 200          | 300 | ns    |
|  |                    | 5               | 10           | 150                 | 250 | -            | -   | ns    |
|  |                    | 10              | 10           | 100                 | 150 | -            | -   | ns    |
| Clock-to-Memory High-Address Byte      | $t_{PLH}, t_{PHL}$ | 5               | 5            | 600                 | 850 | 475          | 525 | ns    |
|  |                    | 5               | 10           | 400                 | 600 | -            | -   | ns    |
|  |                    | 10              | 10           | 300                 | 400 | -            | -   | ns    |
| Clock-to-Memory Low-Address Byte Valid | $t_{PLH}, t_{PHL}$ | 5               | 5            | 250                 | 350 | 175          | 250 | ns    |
|  |                    | 5               | 10           | 150                 | 250 | -            | -   | ns    |
|  |                    | 10              | 10           | 100                 | 150 | -            | -   | ns    |
| Clock to $\overline{\text{MRD}}$       | $t_{PHL}$          | 5               | 5            | 200                 | 300 | 175          | 275 | ns    |
|  |                    | 5               | 10           | 150                 | 250 | -            | -   | ns    |
|  |                    | 10              | 10           | 100                 | 150 | -            | -   | ns    |
| Clock to $\overline{\text{MRD}}$       | $t_{PLH}$          | 5               | 5            | 200                 | 350 | 175          | 275 | ns    |
|  |                    | 5               | 10           | 150                 | 290 | -            | -   | ns    |
|  |                    | 10              | 10           | 100                 | 175 | -            | -   | ns    |
| Clock to $\overline{\text{MWR}}$       | $t_{PLH}, t_{PHL}$ | 5               | 5            | 200                 | 300 | 175          | 225 | ns    |
|  |                    | 5               | 10           | 150                 | 250 | -            | -   | ns    |
|  |                    | 10              | 10           | 100                 | 150 | -            | -   | ns    |
| Clock to (CPU DATA to BUS) Valid       | $t_{PLH}, t_{PHL}$ | 5               | 5            | 300                 | 450 | 250          | 375 | ns    |
|  |                    | 5               | 10           | 250                 | 350 | -            | -   | ns    |
|  |                    | 10              | 10           | 100                 | 200 | -            | -   | ns    |

**CDP1802A, CDP1802AC, CDP1802BC**

**Dynamic Electrical Specifications**  $T_A = -40^{\circ}\text{C}$  to  $+85^{\circ}\text{C}$ ,  $C_L = 50\text{pF}$ ,  $V_{DD} \pm 5\%$ , Except as Noted **(Continued)**

| PARAMETER                            | SYMBOL             | TEST CONDITIONS |              | CDP1802A, CDP1802AC |     | CDP1802BC       |     | UNITS |
|--------------------------------------|--------------------|-----------------|--------------|---------------------|-----|-----------------|-----|-------|
|                                      |                    | $V_{CC}$ (V)    | $V_{DD}$ (V) | (NOTE 1)<br>TYP     | MAX | (NOTE 1)<br>TYP | MAX |       |
| Clock to State Code                  | $t_{PLH}, t_{PHL}$ | 5               | 5            | 300                 | 450 | 250             | 400 | ns    |
|                                      |                    | 5               | 10           | 250                 | 350 | -               | -   | ns    |
|                                      |                    | 10              | 10           | 150                 | 250 | -               | -   | ns    |
| Clock to Q                           | $t_{PLH}, t_{PHL}$ | 5               | 5            | 250                 | 400 | 200             | 300 | ns    |
|                                      |                    | 5               | 10           | 150                 | 250 | -               | -   | ns    |
|                                      |                    | 10              | 10           | 100                 | 150 | -               | -   | ns    |
| Clock to N (0 - 2)                   | $t_{PLH}, t_{PHL}$ | 5               | 5            | 300                 | 550 | 275             | 350 | ns    |
|                                      |                    | 5               | 10           | 200                 | 350 | -               | -   | ns    |
|                                      |                    | 10              | 10           | 150                 | 250 | -               | -   | ns    |
| <b>MINIMUM SET UP AND HOLD TIMES</b> |                    |                 |              |                     |     |                 |     |       |
| Data Bus Input Set Up                | $t_{SU}$           | 5               | 5            | -20                 | 25  | -20             | 0   | ns    |
|                                      |                    | 5               | 10           | 0                   | 50  | -               | -   | ns    |
|                                      |                    | 10              | 10           | -10                 | 40  | -               | -   | ns    |
| Data Bus Input Hold                  | $t_H$<br>(Note 2)  | 5               | 5            | 150                 | 200 | 125             | 150 | ns    |
|                                      |                    | 5               | 10           | 100                 | 125 | -               | -   | ns    |
|                                      |                    | 10              | 10           | 75                  | 100 | -               | -   | ns    |
| $\overline{\text{DMA}}$ Set Up       | $t_{SU}$           | 5               | 5            | 0                   | 30  | 0               | 30  | ns    |
|                                      |                    | 5               | 10           | 0                   | 20  | -               | -   | ns    |
|                                      |                    | 10              | 10           | 0                   | 10  | -               | -   | ns    |
| $\overline{\text{DMA}}$ Hold         | $t_H$<br>(Note 2)  | 5               | 5            | 150                 | 250 | 100             | 150 | ns    |
|                                      |                    | 5               | 10           | 100                 | 200 | -               | -   | ns    |
|                                      |                    | 10              | 10           | 75                  | 125 | -               | -   | ns    |
| Interrupt Set Up                     | $t_{SU}$           | 5               | 5            | -75                 | 0   | -75             | 0   | ns    |
|                                      |                    | 5               | 10           | -50                 | 0   | -               | -   | ns    |
|                                      |                    | 10              | 10           | -25                 | 0   | -               | -   | ns    |
| Interrupt Hold                       | $t_H$<br>(Note 2)  | 5               | 5            | 100                 | 150 | 75              | 125 | ns    |
|                                      |                    | 5               | 10           | 75                  | 100 | -               | -   | ns    |
|                                      |                    | 10              | 10           | 50                  | 75  | -               | -   | ns    |
| $\overline{\text{WAIT}}$ Set Up      | $t_{SU}$           | 5               | 5            | 10                  | 50  | 20              | 40  | ns    |
|                                      |                    | 5               | 10           | -10                 | 15  | -               | -   | ns    |
|                                      |                    | 10              | 10           | 0                   | 25  | -               | -   | ns    |

**CDP1802A, CDP1802AC, CDP1802BC**

**Dynamic Electrical Specifications**  $T_A = -40^{\circ}\text{C}$  to  $+85^{\circ}\text{C}$ ,  $C_L = 50\text{pF}$ ,  $V_{DD} \pm 5\%$ , Except as Noted (Continued)

| PARAMETER  | SYMBOL                      | TEST CONDITIONS |              | CDP1802A, CDP1802AC |     | CDP1802BC    |     | UNITS |
|--|-----------------------------|-----------------|--------------|---------------------|-----|--------------|-----|-------|
|  |                             | $V_{CC}$ (V)    | $V_{DD}$ (V) | (NOTE 1) TYP        | MAX | (NOTE 1) TYP | MAX |       |
| $\overline{\text{EF1-4}}$ Set Up                                   | $t_{\text{SU}}$             | 5               | 5            | -30                 | 20  | -30          | 0   | ns    |
|  |                             | 5               | 10           | -20                 | 30  | -            | -   | ns    |
|  |                             | 10              | 10           | -10                 | 40  | -            | -   | ns    |
| EF1-4 Hold   | $t_{\text{H}}$<br>(Note 2)  | 5               | 5            | 150                 | 200 | 100          | 150 | ns    |
|  |                             | 5               | 10           | 100                 | 150 | -            | -   | ns    |
|  |                             | 10              | 10           | 75                  | 100 | -            | -   | ns    |
| Minimum Pulse Width Times<br>$\overline{\text{CLEAR}}$ Pulse Width | $t_{\text{WL}}$<br>(Note 2) | 5               | 5            | 150                 | 300 | 100          | 150 | ns    |
|  |                             | 5               | 10           | 100                 | 200 | -            | -   | ns    |
|  |                             | 10              | 10           | 75                  | 150 | -            | -   | ns    |
| $\overline{\text{CLOCK}}$ Pulse Width                              | $t_{\text{WL}}$             | 5               | 5            | 125                 | 150 | 90           | 100 | ns    |
|  |                             | 5               | 10           | 100                 | 125 | -            | -   | ns    |
|  |                             | 10              | 10           | 60                  | 75  | -            | -   | ns    |

NOTES:

1. Typical values are for  $T_A = +25^{\circ}\text{C}$  and nominal  $V_{DD}$ .
2. Maximum limits of minimum characteristics are the values above which all devices function.

**Timing Specifications** as a function of  $T(T = 1/f_{\text{CLOCK}})$  at  $T_A = -40$  to  $+85^{\circ}\text{C}$ , Except as Noted

| PARAMETERS   | SYMBOL          | TEST CONDITIONS |              | CDP1802A, CDP1802AC |              | CDP1802BC |              | UNITS |
|--|-----------------|-----------------|--------------|---------------------|--------------|-----------|--------------|-------|
|  |                 | $V_{CC}$ (V)    | $V_{DD}$ (V) | MIN                 | (NOTE 1) TYP | MIN       | (NOTE 1) TYP |       |
| High-Order Memory-Address Byte Set Up to TPA  Time | $t_{\text{SU}}$ | 5               | 5            | 2T-550              | 2T-400       | 2T-325    | 2T-275       | ns    |
|  |                 | 5               | 10           | 2T-350              | 2T-250       | -         | -            | ns    |
|  |                 | 10              | 10           | 2T-250              | 2T-200       | -         | -            | ns    |
| High-Order Memory-Address Byte Hold After TPA Time | $t_{\text{H}}$  | 5               | 5            | $t/2-25$            | $T/2-15$     | $T/2-25$  | $T/2-15$     | ns    |
|  |                 | 5               | 10           | $T/2-35$            | $T/2-25$     | -         | -            | ns    |
|  |                 | 10              | 10           | $T/2-10$            | $T/2+0$      | -         | -            | ns    |
| Low-Order Memory-Address Byte Hold After WR Time   | $t_{\text{H}}$  | 5               | 5            | T-30                | T+0          | T-30      | T+0          | ns    |
|  |                 | 5               | 10           | T-20                | T+0          | -         | -            | ns    |
|  |                 | 10              | 10           | T-10                | T+0          | -         | -            | ns    |
| CPU Data to Bus Hold After WR Time                 | $t_{\text{H}}$  | 5               | 5            | T-200               | T-150        | T-175     | T-125        | ns    |
|  |                 | 5               | 10           | T-150               | T-100        | -         | -            | ns    |
|  |                 | 10              | 10           | T-100               | T-50         | -         | -            | ns    |



## CDP1802A, CDP1802AC, CDP1802BC

**Timing Specifications** as a function of T (T = 1/f<sub>CLOCK</sub>) at T<sub>A</sub> = -40 to +85°C, Except as Noted

| PARAMETERS                                     | SYMBOL           | TEST CONDITIONS     |                     | CDP1802A,<br>CDP1802AC |                 | CDP1802BC |                 | UNITS |
|--|------------------|---------------------|---------------------|------------------------|-----------------|-----------|-----------------|-------|
|  |                  | V <sub>CC</sub> (V) | V <sub>DD</sub> (V) | MIN                    | (NOTE 1)<br>TYP | MIN       | (NOTE 1)<br>TYP |       |
| Required Memory Access Time<br>Address to Data | t <sub>ACC</sub> | 5                   | 5                   | 5T-375                 | 5T-250          | 5T-225    | 5T-175          | ns    |
|  |                  | 5                   | 10                  | 5T-250                 | 5T-150          | -         | -               | ns    |
|  |                  | 10                  | 10                  | 5T-190                 | 5T-100          | -         | -               | ns    |
| MRD to TPA                                     | t <sub>SU</sub>  | 5                   | 5                   | T/2-25                 | T/2-18          | T/2-20    | T/2-15          | ns    |
|  |                  | 5                   | 10                  | T/2-20                 | T/2-15          | -         | -               | ns    |
|  |                  | 10                  | 10                  | T/2-15                 | T/2-10          | -         | -               | ns    |

NOTE:

1. Typical values are for T<sub>A</sub> = +25°C and nominal V<sub>DD</sub>.

### Timing Waveforms

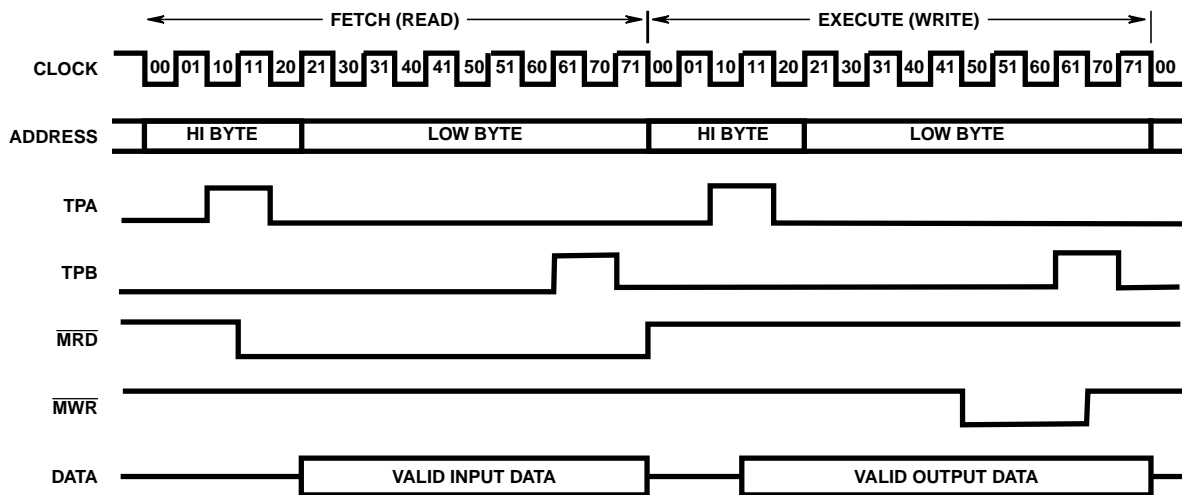
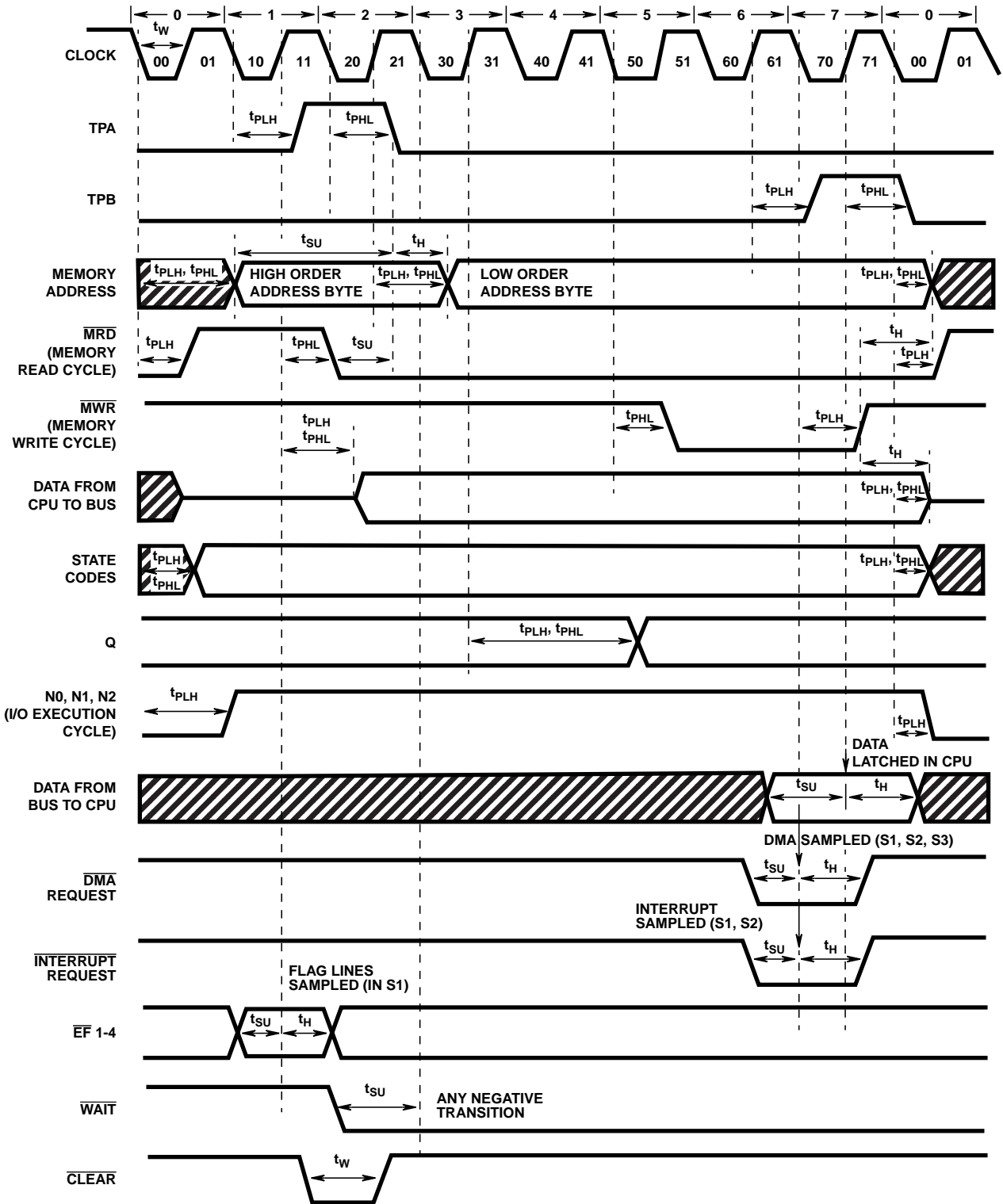

FIGURE 3. BASIC DC TIMING WAVEFORM, ONE INSTRUCTION CYCLE

CDP1802A, CDP1802AC, CDP1802BC

Timing Waveforms (Continued)



NOTES:

1. This timing diagram is used to show signal relationships only and does not represent any specific machine cycle.
2. All measurements are referenced to 50% point of the waveforms.
3. Shaded areas indicate "Don't Care" or undefined state. Multiple transitions may occur during this period.

FIGURE 4. TIMING WAVEFORM

CDP1802A, CDP1802AC, CDP1802BC

Machine Cycle Timing Waveforms (Propagation Delays Not Shown)

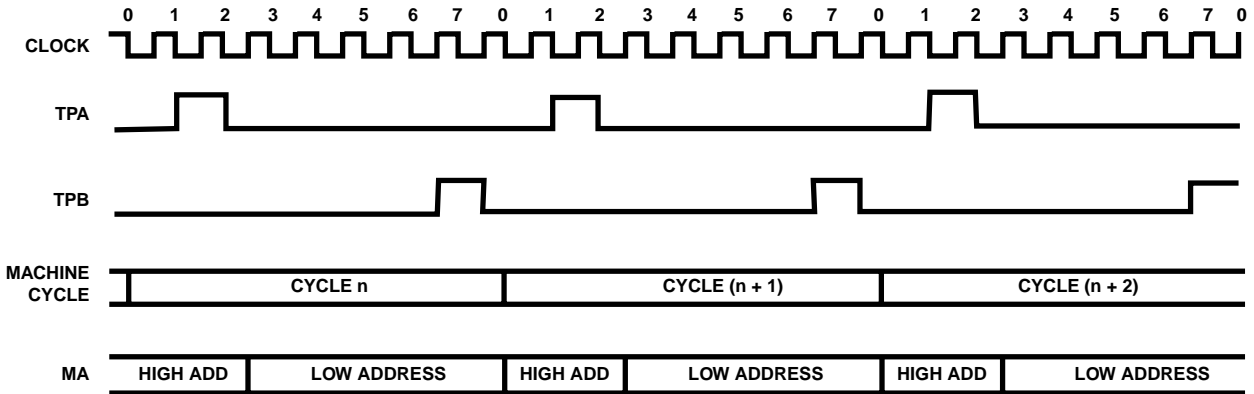

FIGURE 5. GENERAL TIMING WAVEFORMS

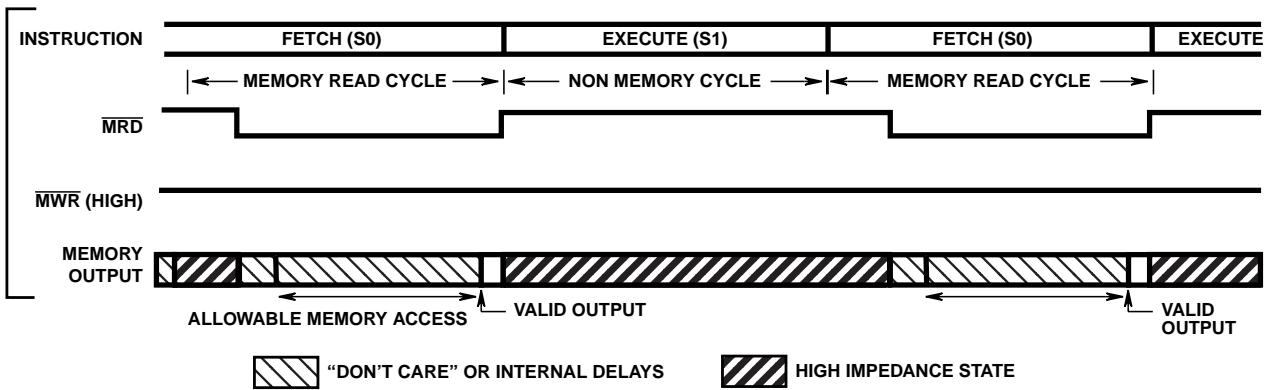

FIGURE 6. NON-MEMORY CYCLE TIMING WAVEFORMS

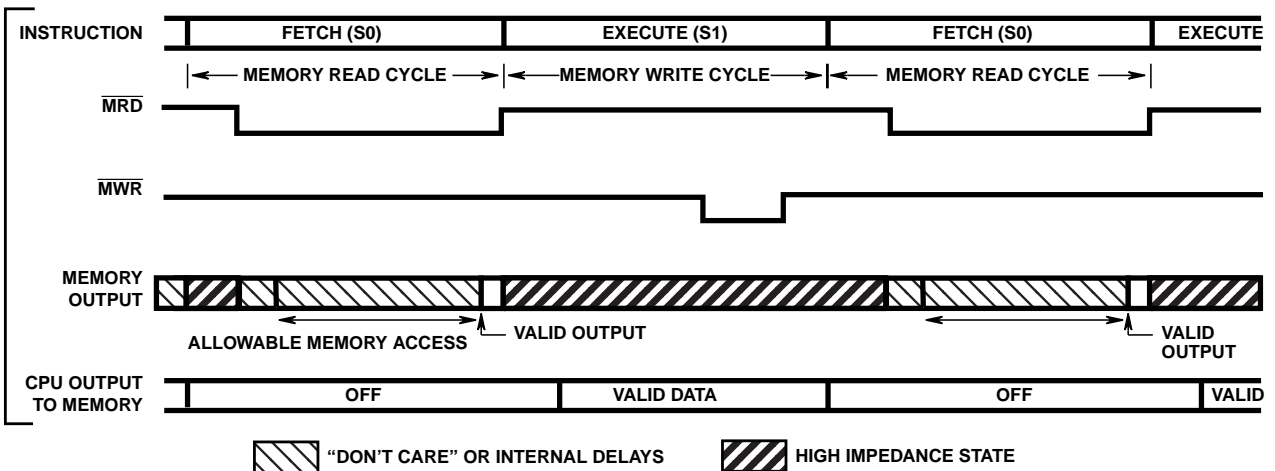

FIGURE 7. MEMORY WRITE CYCLE TIMING WAVEFORMS

**Machine Cycle Timing Waveforms** (Propagation Delays Not Shown) (Continued)

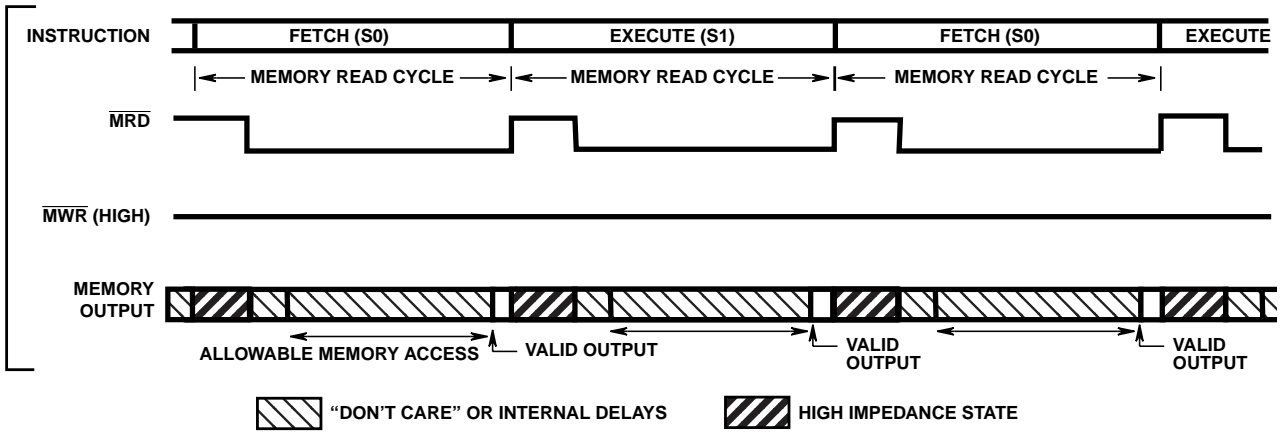

FIGURE 8. MEMORY READ CYCLE TIMING WAVEFORMS

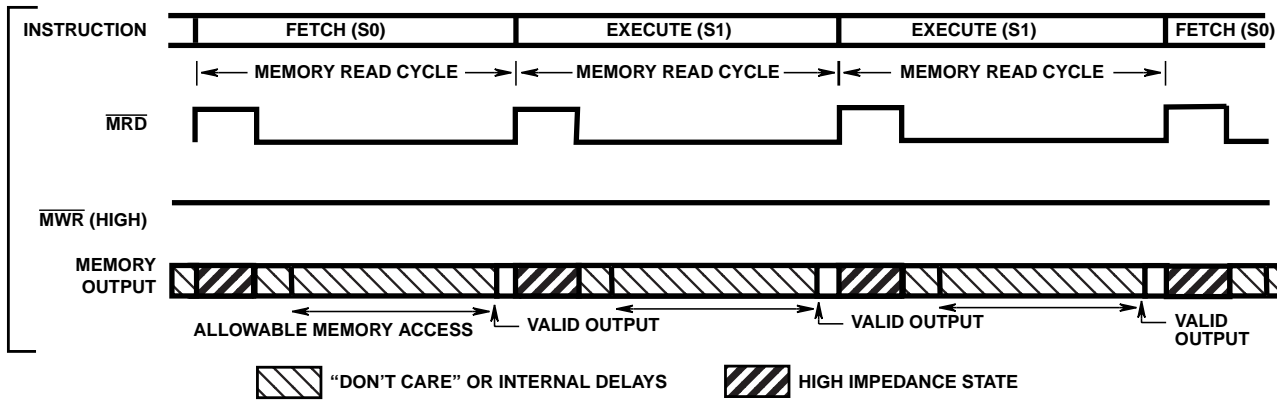

FIGURE 9. LONG BRANCH OR LONG SKIP CYCLE TIMING WAVEFORMS

CDP1802A, CDP1802AC, CDP1802BC

Machine Cycle Timing Waveforms (Propagation Delays Not Shown) (Continued)

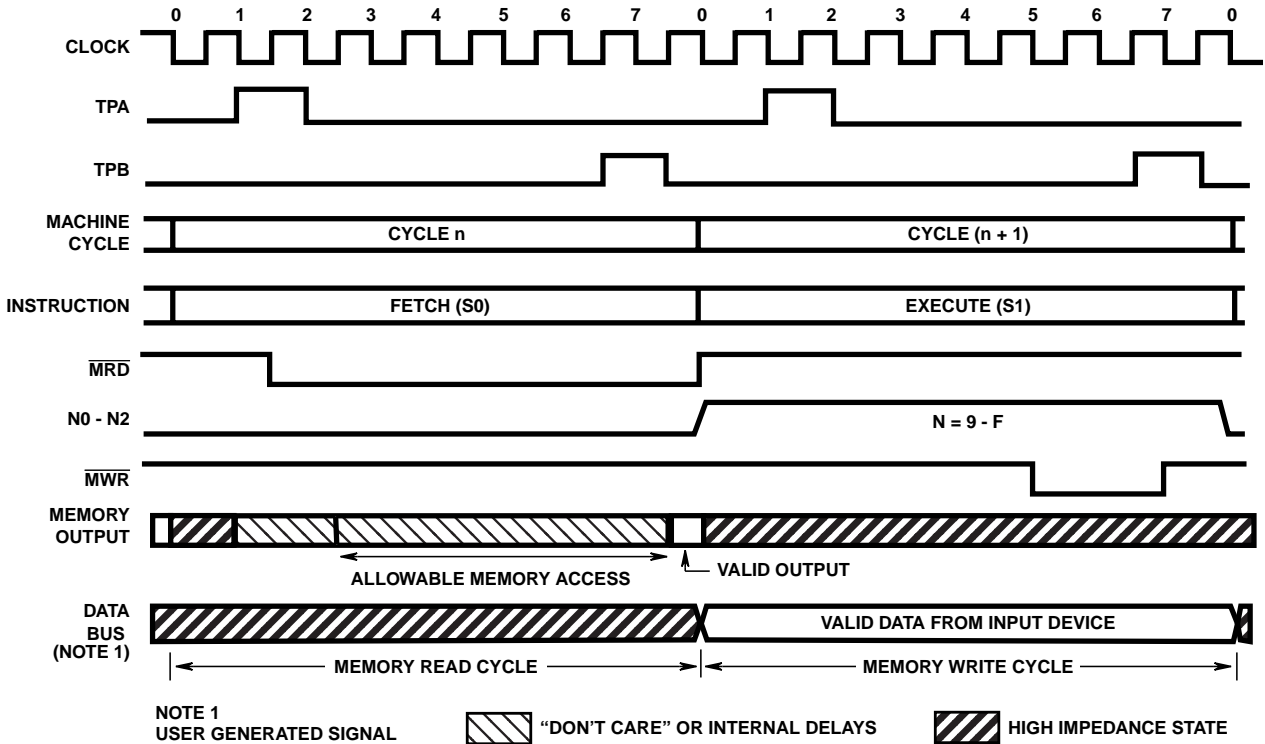

FIGURE 10. INPUT CYCLE TIMING WAVEFORMS

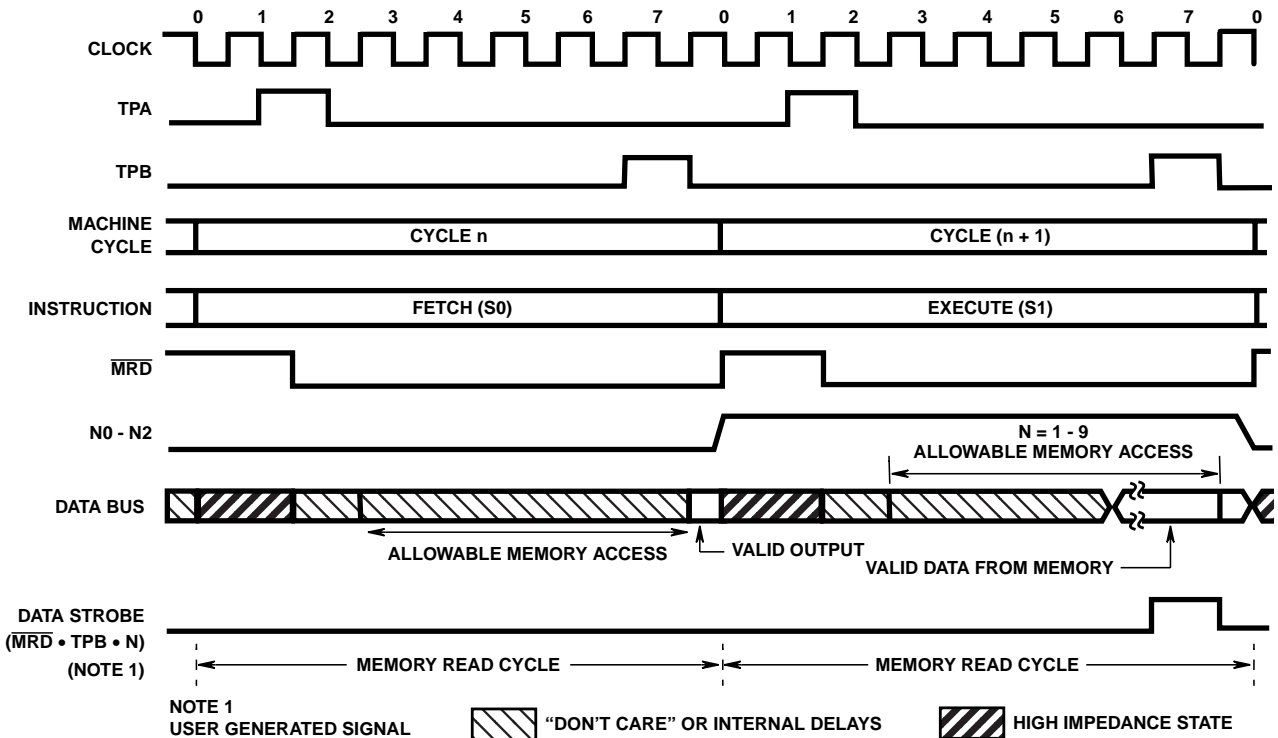

FIGURE 11. OUTPUT CYCLE TIMING WAVEFORMS

CDP1802A, CDP1802AC, CDP1802BC

Machine Cycle Timing Waveforms (Propagation Delays Not Shown) (Continued)

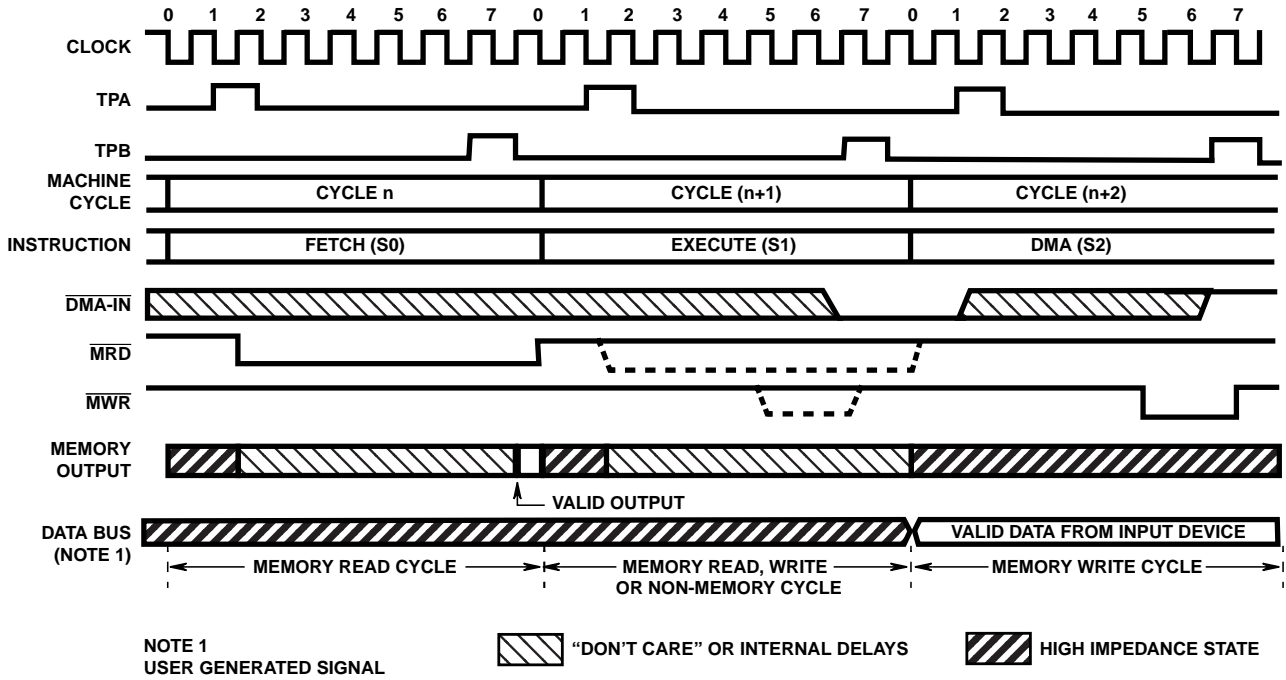

FIGURE 12. DMA IN CYCLE TIMING WAVEFORMS

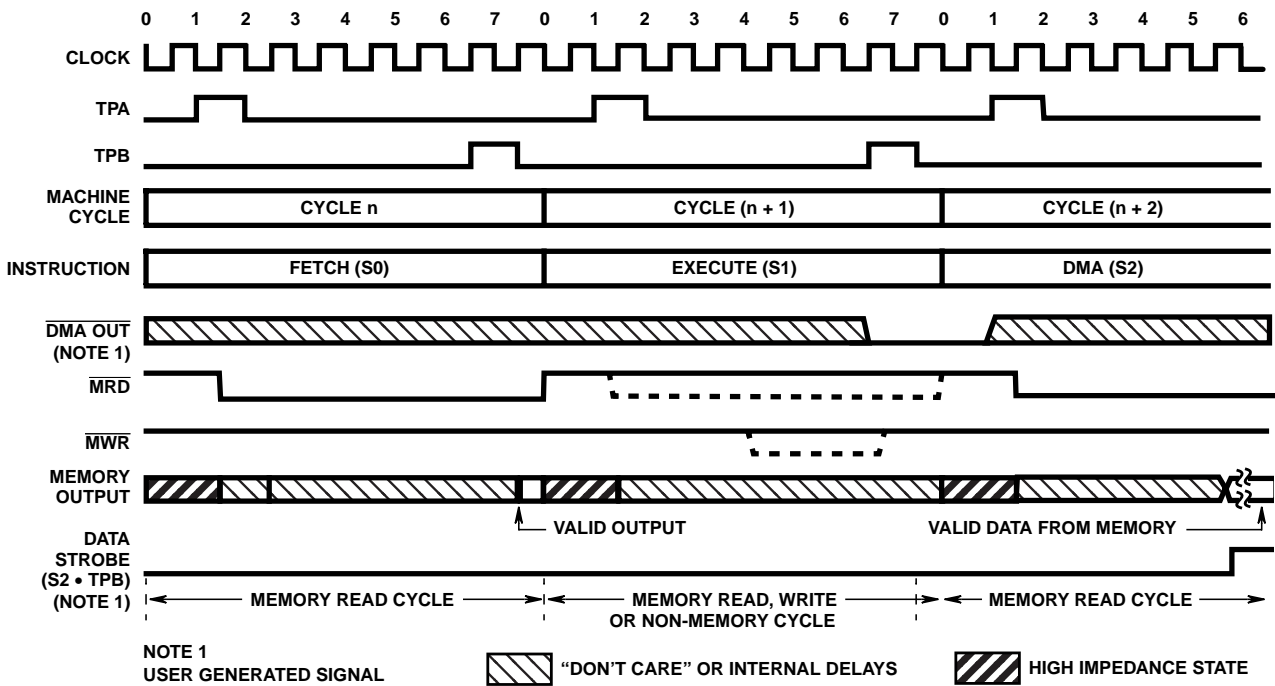

FIGURE 13. DMA OUT CYCLE TIMING WAVEFORMS

CDP1802A, CDP1802AC, CDP1802BC

Machine Cycle Timing Waveforms (Propagation Delays Not Shown) (Continued)

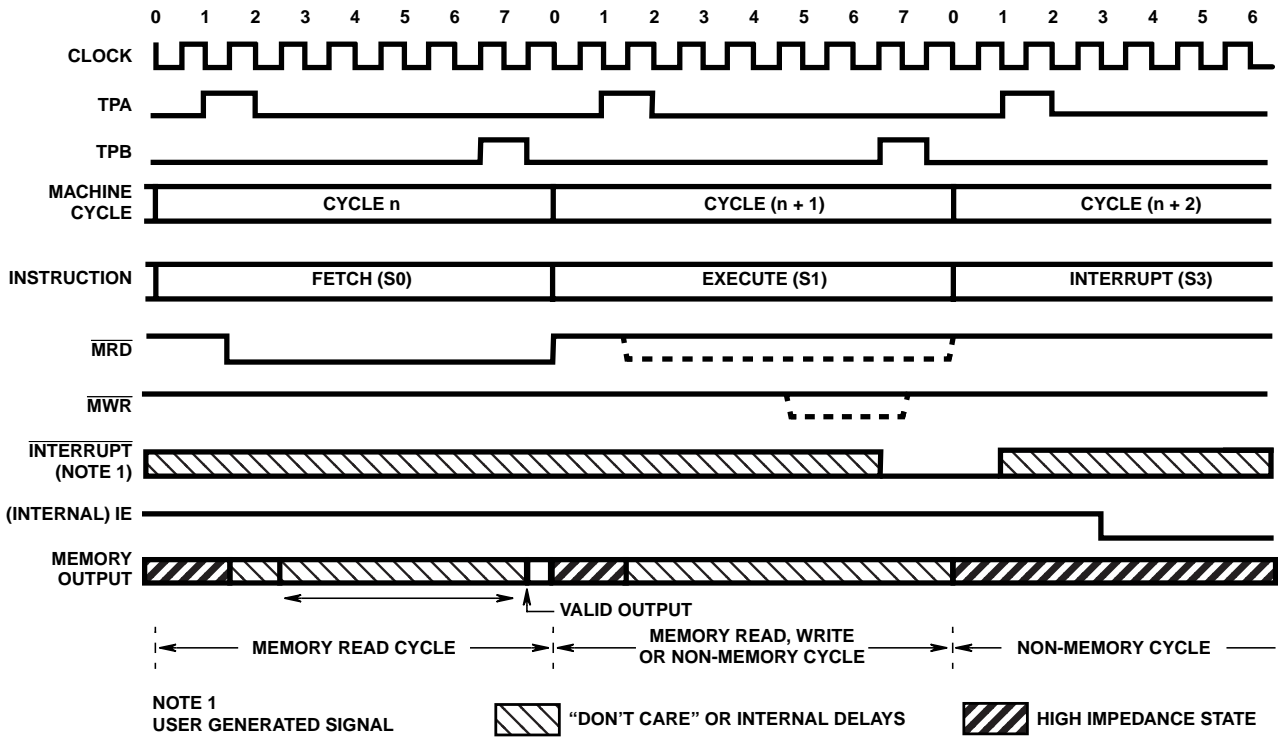

FIGURE 14. INTERRUPT CYCLE TIMING WAVEFORMS

Performance Curves

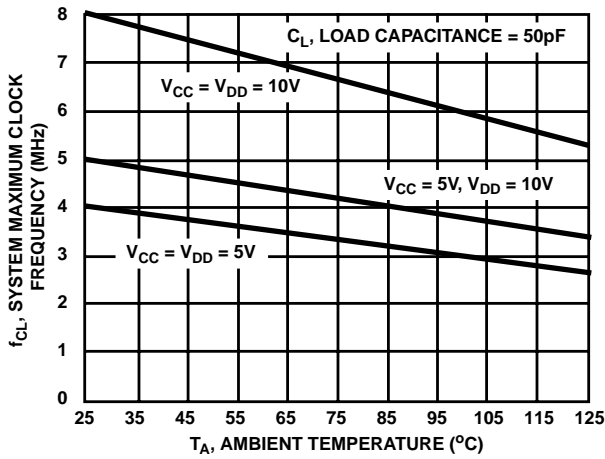

FIGURE 15. CDP1802A, AC TYPICAL MAXIMUM CLOCK FREQUENCY AS A FUNCTION OF TEMPERATURE

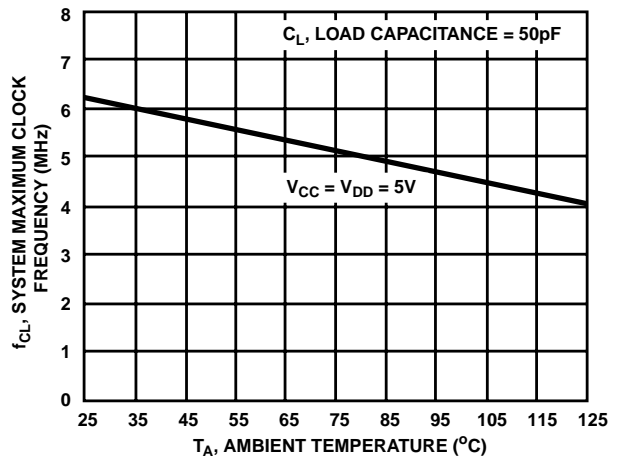

FIGURE 16. CDP1802BC TYPICAL MAXIMUM CLOCK FREQUENCY AS A FUNCTION OF TEMPERATURE

CDP1802A, CDP1802AC, CDP1802BC

Performance Curves (Continued)

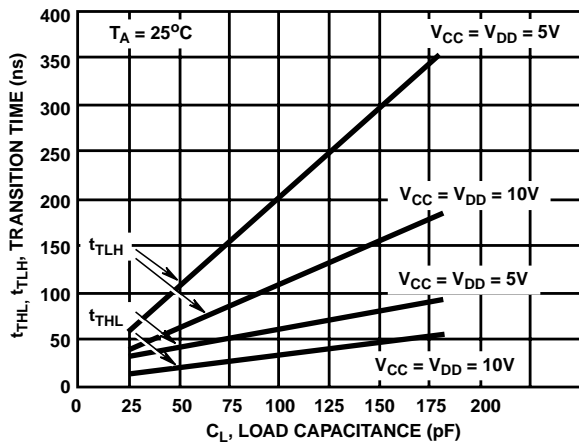

FIGURE 17. TYPICAL TRANSITION TIME vs LOAD CAPACITANCE FOR ALL TYPES

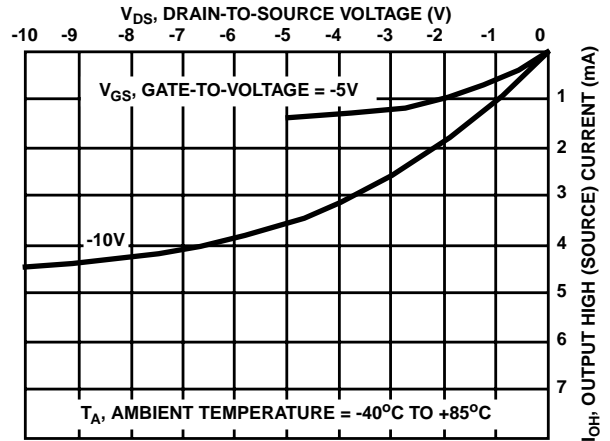

FIGURE 18. CDP1802A, AC MINIMUM OUTPUT HIGH (SOURCE) CURRENT CHARACTERISTICS

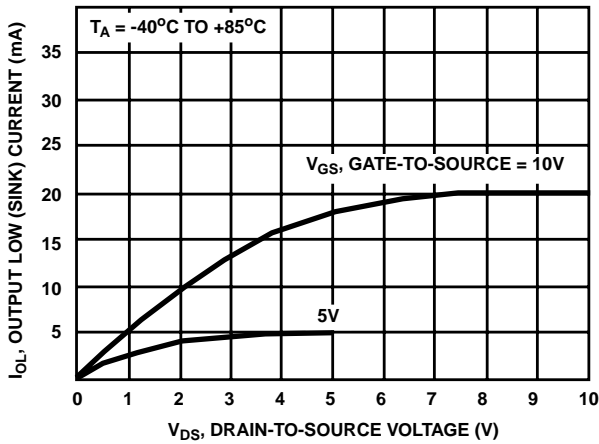

FIGURE 19. CDP1802A, AC MINIMUM OUTPUT LOW (SINK) CURRENT CHARACTERISTICS

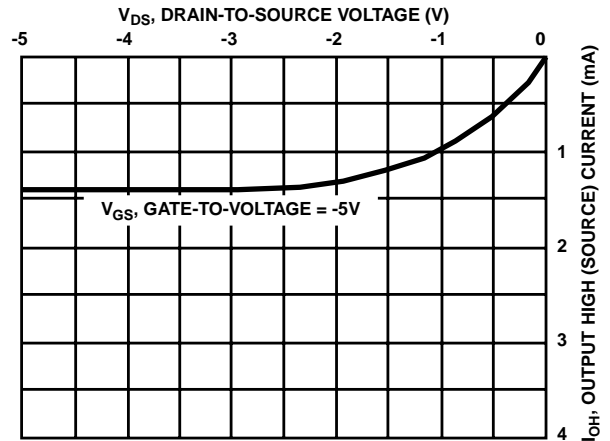

FIGURE 20. CDP1802BC MINIMUM OUTPUT HIGH (SOURCE) CURRENT CHARACTERISTICS

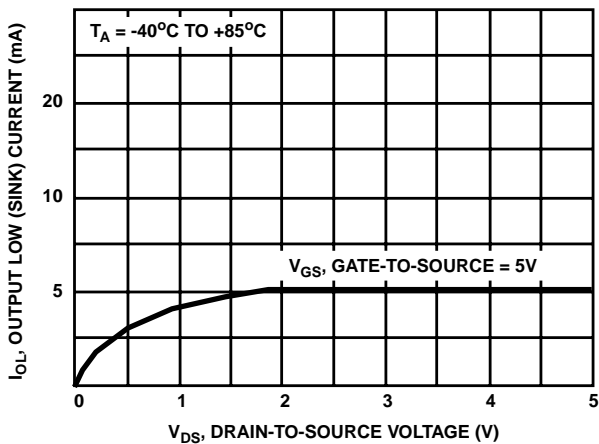
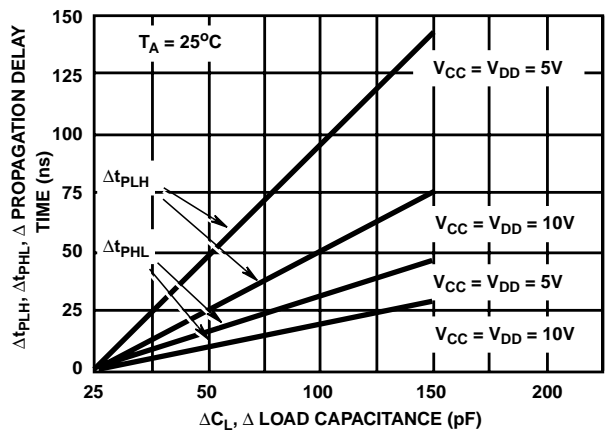

FIGURE 21. CDP1802BC MINIMUM OUTPUT LOW (SINK) CURRENT CHARACTERISTICS



NOTE: ANY OUTPUT EXCEPT XTAL

FIGURE 22. TYPICAL CHANGE IN PROPAGATION DELAY AS A FUNCTION OF A CHANGE IN LOAD CAPACITANCE FOR ALL TYPES



## CDP1802A, CDP1802AC, CDP1802BC

### Performance Curves (Continued)

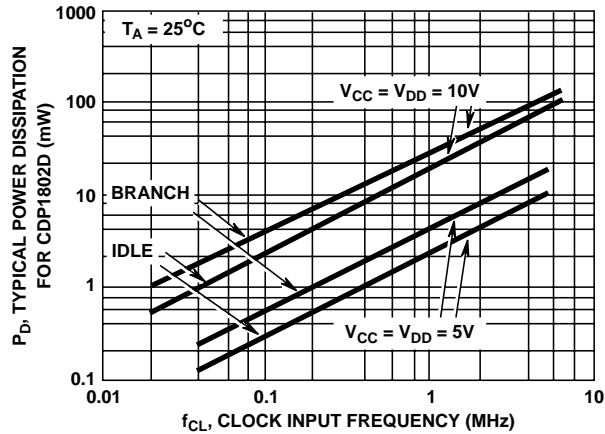

NOTE: IDLE = "00" AT M(0000), BRANCH = "3707" AT M(8107), CL = 50pF

**FIGURE 23. TYPICAL POWER DISSIPATION AS A FUNCTION OF CLOCK FREQUENCY FOR BRANCH INSTRUCTION AND IDLE INSTRUCTION FOR ALL TYPES**

### Signal Descriptions

#### Bus 0 to Bus 7 (Data Bus)

8-bit bidirectional DATA BUS lines. These lines are used for transferring data between the memory, the microprocessor, and I/O devices.

#### N0 to N2 (I/O Control Lines)

Activated by an I/O instruction to signal the I/O control logic of a data transfer between memory and I/O interface. These lines can be used to issue command codes or device selection codes to the I/O devices (independently or combined with the memory byte on the data bus when an I/O instruction is being executed). The N bits are low at all times except when an I/O instruction is being executed. During this time their state is the same as the corresponding bits in the N register.

The direction of data flow is defined in the I/O instruction by bit N3 (internally) and is indicated by the level of the MRD signal.

$\overline{\text{MRD}} = V_{\text{CC}}$ : Data from I/O to CPU and Memory

$\overline{\text{MRD}} = V_{\text{SS}}$ : Data from Memory to I/O

#### EF1 to EF4 (4 Flags)

These inputs enable the I/O controllers to transfer status information to the processor. The levels can be tested by the conditional branch instructions. They can be used in conjunction with the INTERRUPT request line to establish interrupt priorities. These flags can also be used by I/O devices to "call the attention" of the processor, in which case the program must routinely test the status of these flag(s). The flag(s) are sampled at the beginning of every S1 cycle.

#### INTERRUPT, DMA-IN, DMA-OUT (3 I/O Requests)

These inputs are sampled by the CPU during the interval between the leading edge of TPB and the leading edge of TPA.

**Interrupt Action** - X and P are stored in T after executing current instruction; designator X is set to 2; designator P is set to 1; interrupt enable is reset to 0 (inhibit); and instruction execution is resumed. The interrupt action requires one machine cycle (S3).

**DMA Action** - Finish executing current instruction; R(0) points to memory area for data transfer; data is loaded into or read out of memory; and increment R(0).

NOTE: In the event of concurrent DMA and Interrupt requests, DMA-IN has priority followed by DMA-OUT and then Interrupt.

#### SC0, SC1, (2 State Code Lines)

These outputs indicate that the CPU is: 1) fetching an instruction, or 2) executing an instruction, or 3) processing a DMA request, or 4) acknowledging an interrupt request. The levels of state code are tabulated below. All states are valid at TPA. H =  $V_{\text{CC}}$ , L =  $V_{\text{SS}}$ .

| STATE TYPE     | STATE CODE LINES |     |
|----------------|------------------|-----|
|                | SC1              | SC0 |
| S0 (Fetch)     | L                | L   |
| S1 (Execute)   | L                | H   |
| S2 (DMA)       | H                | L   |
| S3 (Interrupt) | H                | H   |

#### TPA, TPB (2 Timing Pulses)

Positive pulses that occur once in each machine cycle (TPB follows TPA). They are used by I/O controllers to interpret codes and to time interaction with the data bus. The trailing edge of TPA is used by the memory system to latch the higher-order byte of the 16-bit memory address. TPA is suppressed in IDLE when the CPU is in the load mode.

## CDP1802A, CDP1802AC, CDP1802BC

### MA0 to MA7 (8 Memory Address Lines)

In each cycle, the higher-order byte of a 16-bit CPU memory address appears on the memory address lines MA0-7 first. Those bits required by the memory system can be strobed into external address latches by timing pulse TPA. The low order byte of the 16-bit address appears on the address lines after the termination of TPA. Latching of all 8 higher-order address bits would permit a memory system of 64K bytes.

### $\overline{\text{MWR}}$ (Write Pulse)

A negative pulse appearing in a memory-write cycle, after the address lines have stabilized.

### $\overline{\text{MRD}}$ (Read Level)

A low level on MRD indicates a memory read cycle. It can be used to control three-state outputs from the addressed memory which may have a common data input and output bus. If a memory does not have a three-state high-impedance output, MRD is useful for driving memory/bus separator gates. It is also used to indicate the direction of data transfer during an I/O instruction. For additional information see Table 1.

### Q

Single bit output from the CPU which can be set or reset under program control. During SEQ or REQ instruction execution, Q is set or reset between the trailing edge of TPA and the leading edge of TPB.

### CLOCK

Input for externally generated single-phase clock. The clock is counted down internally to 8 clock pulses per machine cycle.

### XTAL

Connection to be used with clock input terminal, for an external crystal, if the on-chip oscillator is utilized. The crystal is connected between terminals 1 and 39 (CLOCK and XTAL) in parallel with a resistance (10M $\Omega$  typ). Frequency trimming capacitors may be required at terminals 1 and 39. For additional information, see Application Note AN6565.

### $\overline{\text{WAIT}}$ , $\overline{\text{CLEAR}}$ (2 Control Lines)

Provide four control modes as listed in the following truth table:

| CLEAR | WAIT | MODE  |
|-------|------|-------|
| L     | L    | LOAD  |
| L     | H    | RESET |
| H     | L    | PAUSE |
| H     | H    | RUN   |

### $V_{DD}$ , $V_{SS}$ , $V_{CC}$ (Power Levels)

The internal voltage supply  $V_{DD}$  is isolated from the Input/Output voltage supply  $V_{CC}$  so that the processor may operate at maximum speed while interfacing with peripheral devices operating at lower voltage.  $V_{CC}$  must be less than or equal to  $V_{DD}$ . All outputs swing from  $V_{SS}$  to  $V_{CC}$ . The recommended input voltage swing is  $V_{SS}$  to  $V_{CC}$ .

### Architecture

The CPU block diagram is shown in Figure 2. The principal feature of this system is a register array (R) consisting of sixteen 16-bit scratchpad registers. Individual registers in the array (R) are designated (selected) by a 4-bit binary code from one of the 4-bit registers labeled N, P and X. The contents of any register can be directed to any one of the following three paths:

1. The external memory (multiplexed, higher-order byte first, on to 8 memory address lines).
2. The D register (either of the two bytes can be gated to D).
3. The increment/decrement circuit where it is increased or decreased by one and stored back in the selected 16-bit register.

The three paths, depending on the nature of the instruction, may operate independently or in various combinations in the same machine cycle.

With two exceptions, CPU instruction consists of two 8-clock-pulse machine cycles. The first cycle is the fetch cycle, and the second - and third if necessary - are execute cycles. During the fetch cycle the four bits in the P designator select one of the 16 registers R(P) as the current program counter. The selected register R(P) contains the address of the memory location from which the instruction is to be fetched. When the instruction is read out from the memory, the higher order 4 bits of the instruction byte are loaded into the register and the lower order 4 bits into the N register. The content of the program counter is automatically incremented by one so that R(P) is now "pointing" to the next byte in the memory.

The X designator selects one of the 16 registers R(X) to "point" to the memory for an operand (or data) in certain ALU or I/O operations.

The N designator can perform the following five functions depending on the type of instruction fetched:

1. Designate one of the 16 registers in R to be acted upon during register operations.
2. Indicate to the I/O devices a command code or device selection code for peripherals.
3. Indicate the specific operation to be executed during the ALU instructions, types of test to be performed during the Branch instruction, or the specific operation required in a class of miscellaneous instructions (70 - 73 and 78 - 7B).
4. Indicate the value to be loaded into P to designate a new register to be used as the program counter R(P).
5. Indicate the value to be loaded into X to designate a new register to be used as data pointer R(X).

The registers in R can be assigned by a programmer in three different ways: as program counters, as data pointers, or as scratchpad locations (data registers) to hold two bytes of data.

### Program Counters

Any register can be the main program counter; the address of the selected register is held in the P designator. Other reg-

## CDP1802A, CDP1802AC, CDP1802BC

isters in R can be used as subroutine program counters. By single instruction the contents of the P register can be changed to effect a "call" to a subroutine. When interrupts are being serviced, register R(1) is used as the program counter for the user's interrupt servicing routine. After reset, and during a DMA operation, R(0) is used as the program counter. At all other times the register designated as program counter is at the discretion of the user.

### Data Pointers

The registers in R may be used as data pointers to indicate a location in memory. The register designated by X (i.e., R(X)) points to memory for the following instructions (see Table 1).

1. ALU operations F1 - F5, F7, 74, 75, 77
2. Output instructions 61 through 67
3. Input instructions 69 through 6F
4. Certain miscellaneous instructions - 70 - 73, 78, 60, F0

The register designated by N (i.e., R(N)) points to memory for the "load D from memory" instructions 0N and 4N and the "Store D" instruction 5N. The register designated by P (i.e., the program counter) is used as the data pointer for ALU instructions F8 - FD, FF, 7C, 7D, 7F. During these instruction executions, the operation is referred to as "data immediate".

Another important use of R as a data pointer supports the built-in Direct-Memory-Access (DMA) function. When a DMA-In or DMA-Out request is received, one machine cycle is "stolen". This operation occurs at the end of the execute machine cycle in the current instruction. Register R(0) is always used as the data pointer during the DMA operation. The data is read from (DMA-Out) or written into (DMA-In) the memory location pointed to by the R(0) register. At the end of the transfer, R(0) is incremented by one so that the processor is ready to act upon the next DMA byte transfer request. This feature in the 1800-series architecture saves a substantial amount of logic when fast exchanges of blocks of data are required, such as with magnetic discs or during CRT-display-refresh cycles.

### Data Registers

When registers in R are used to store bytes of data, four instructions are provided which allow D to receive from or write into either the higher-order or lower-order byte portions of the register designated by N. By this mechanism (together with loading by data immediate) program pointer and data pointer designations are initialized. Also, this technique allows scratchpad registers in R to be used to hold general data. By employing increment or decrement instructions, such registers may be used as loop counters.

### The Q Flip-Flop

An internal flip-flop, Q, can be set or reset by instruction and can be sensed by conditional branch instructions. The output of Q is also available as a microprocessor output.

### Interrupt Servicing

Register R(1) is always used as the program counter whenever interrupt servicing is initiated. When an interrupt request occurs and the interrupt is allowed by the program (again, nothing takes place until the completion of the current instruction), the contents of the X and P registers are stored in the temporary register T, and X and P are set to new values; hex digit 2 in X and hex digit 1 in P. Interrupt Enable is automatically deactivated to inhibit further interrupts. The user's interrupt routine is now in control; the contents of T may be saved by means of a single instruction (78) in the memory location pointed to by R(X). At the conclusion of the interrupt, the user's routine may restore the pre-interrupted value of X and P with a single instruction (70 or 71). The Interrupt Enable flip-flop can be activated to permit further interrupts or can be disabled to prevent them.

### CPU Register Summary

|    |         |   |
|----|---------|---|
| D  | 8 Bits  | Data Register (Accumulator)                       |
| DF | 1-Bit   | Data Flag (ALU Carry)                             |
| B  | 8 Bits  | Auxiliary Holding Register                        |
| R  | 16 Bits | 1 of 16 Scratchpad Registers                      |
| P  | 4 Bits  | Designates which register is Program Counter      |
| X  | 4 Bits  | Designates which register is Data Pointer         |
| N  | 4 Bits  | Holds Low-Order Instruction Digit                 |
| I  | 4 Bits  | Holds High-Order Instruction Digit                |
| T  | 8 Bits  | Holds old X, P after Interrupt (X is high nibble) |
| IE | 1-Bit   | Interrupt Enable                                  |
| Q  | 1-Bit   | Output Flip-Flop                                  |

### CDP1802 Control Modes

The  $\overline{\text{WAIT}}$  and  $\overline{\text{CLEAR}}$  lines provide four control modes as listed in the following truth table:

| $\overline{\text{CLEAR}}$ | $\overline{\text{WAIT}}$ | MODE  |
|---------------------------|--------------------------|-------|
| L                         | L                        | LOAD  |
| L                         | H                        | RESET |
| H                         | L                        | PAUSE |
| H                         | H                        | RUN   |

The function of the modes are defined as follows:

#### Load

Holds the CPU in the IDLE execution state and allows an I/O device to load the memory without the need for a "bootstrap" loader. It modifies the IDLE condition so that DMA-IN operation does not force execution of the next instruction.

#### Reset

Registers I, N, Q are reset, IE is set and 0's (VSS) are placed on the data bus. TPA and TPB are suppressed while reset is held and the CPU is placed in S1. The first machine cycle after termination of reset is an initialization cycle which requires 9 clock pulses. During this cycle the CPU remains in S1 and register X, P, and R(0) are reset. Interrupt and DMA servicing are

## CDP1802A, CDP1802AC, CDP1802BC

suppressed during the initialization cycle. The next cycle is an S0, S1, or an S2 but never an S3. With the use of a 71 instruction followed by 00 at memory locations 0000 and 0001, this feature may be used to reset IE, so as to preclude interrupts until ready for them. Power-up reset can be realized by connecting an RC network directly to the CLEAR pin, since it has a Schmitt triggered input, see Figure 24.

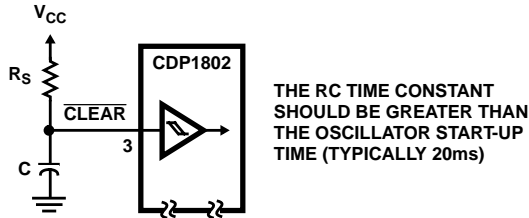

FIGURE 24. RESET DIAGRAM

### Pause

Stops the internal CPU timing generator on the first negative high-to-low transition of the input clock. The oscillator continues to operate, but subsequent clock transitions are ignored.

### Run

May be initiated from the Pause or Reset mode functions. If initiated from Pause, the CPU resumes operation on the first negative high-to-low transition of the input clock. When initiated from the Reset operation, the first machine cycle following Reset is always the initialization cycle. The initialization cycle is then followed by a DMA (S2) cycle or fetch (S0) from location 0000 in memory.

### Run-Mode State Transitions

The CPU state transitions when in the RUN and RESET modes are shown in Figure 25. Each machine cycle requires the same period of time, 8 clock pulses, except the initialization cycle, which requires 9 clock pulses. The execution of an instruction requires either two or three machine cycles, S0 followed by a single S1 cycle or two S1 cycles. S2 is the response to a DMA request and S3 is the interrupt response. Table 2 shows the conditions on Data Bus and Memory Address lines during all machine states.

### Instruction Set

The CPU instruction summary is given in Table 1. Hexadecimal notation is used to refer to the 4-bit binary codes.

In all registers bits are numbered from the least significant bit (LSB) to the most significant bit (MSB) starting with 0.

R(W): Register designated by W, where

W = N or X, or P

R(W).0: Lower order byte of R(W)

R(W).1: Higher order byte of R(W)

Operation Notation

$M(R(N)) \rightarrow D; R(N) + 1 \rightarrow R(N)$

This notation means: The memory byte pointed to by R(N) is loaded into D, and R(N) is incremented by 1.

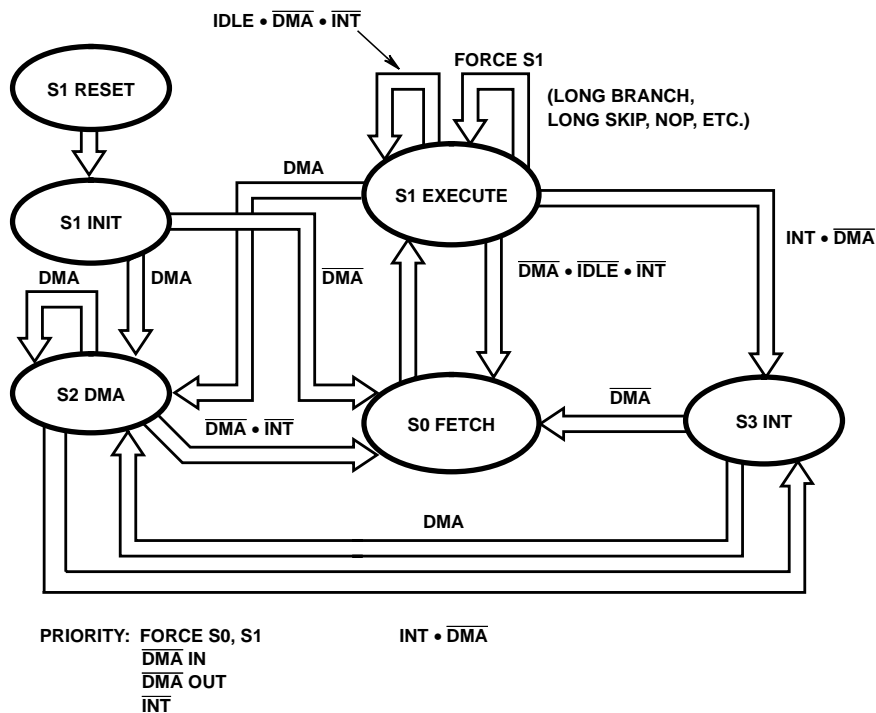

FIGURE 25. STATE TRANSITION DIAGRAM

**CDP1802A, CDP1802AC, CDP1802BC**

**TABLE 1. INSTRUCTION SUMMARY (SEE NOTES)**

| INSTRUCTION                           | MNEMONIC | OP CODE        | OPERATION  |
|---------------------------------------|----------|----------------|--|
| <b>MEMORY REFERENCE</b>               |          |                |  |
| LOAD VIA N                            | LDN      | 0N             | $M(R(N)) \rightarrow D$ ; FOR N not 0                                |
| LOAD ADVANCE                          | LDA      | 4N             | $M(R(N)) \rightarrow D$ ; $R(N) + 1 \rightarrow R(N)$                |
| LOAD VIA X                            | LDX      | F0             | $M(R(X)) \rightarrow D$  |
| LOAD VIA X AND ADVANCE                | LDXA     | 72             | $M(R(X)) \rightarrow D$ ; $R(X) + 1 \rightarrow R(X)$                |
| LOAD IMMEDIATE                        | LDI      | F8             | $M(R(P)) \rightarrow D$ ; $R(P) + 1 \rightarrow R(P)$                |
| STORE VIA N                           | STR      | 5N             | $D \rightarrow M(R(N))$  |
| STORE VIA X AND DECREMENT             | STXD     | 73             | $D \rightarrow M(R(X))$ ; $R(X) - 1 \rightarrow R(X)$                |
| <b>REGISTER OPERATIONS</b>            |          |                |  |
| INCREMENT REG N                       | INC      | 1N             | $R(N) + 1 \rightarrow R(N)$  |
| DECREMENT REG N                       | DEC      | 2N             | $R(N) - 1 \rightarrow R(N)$  |
| INCREMENT REG X                       | IRX      | 60             | $R(X) + 1 \rightarrow R(X)$  |
| GET LOW REG N                         | GLO      | 8N             | $R(N).0 \rightarrow D$   |
| PUT LOW REG N                         | PLO      | AN             | $D \rightarrow R(N).0$   |
| GET HIGH REG N                        | GHI      | 9N             | $R(N).1 \rightarrow D$   |
| PUT HIGH REG N                        | PHI      | BN             | $D \rightarrow R(N).1$   |
| <b>LOGIC OPERATIONS (Note 1)</b>      |          |                |  |
| OR                                    | OR       | F1             | $M(R(X)) \text{ OR } D \rightarrow D$                                |
| OR IMMEDIATE                          | ORI      | F9             | $M(R(P)) \text{ OR } D \rightarrow D$ ; $R(P) + 1 \rightarrow R(P)$  |
| EXCLUSIVE OR                          | XOR      | F3             | $M(R(X)) \text{ XOR } D \rightarrow D$                               |
| EXCLUSIVE OR IMMEDIATE                | XRI      | FB             | $M(R(P)) \text{ XOR } D \rightarrow D$ ; $R(P) + 1 \rightarrow R(P)$ |
| AND                                   | AND      | F2             | $M(R(X)) \text{ AND } D \rightarrow D$                               |
| AND IMMEDIATE                         | ANI      | FA             | $M(R(P)) \text{ AND } D \rightarrow D$ ; $R(P) + 1 \rightarrow R(P)$ |
| SHIFT RIGHT                           | SHR      | F6             | SHIFT D RIGHT, $LSB(D) \rightarrow DF$ , $0 \rightarrow MSB(D)$      |
| SHIFT RIGHT WITH CARRY                | SHRC     | 76<br>(Note 2) | SHIFT D RIGHT, $LSB(D) \rightarrow DF$ , $DF \rightarrow MSB(D)$     |
| RING SHIFT RIGHT                      | RSHR     | 76<br>(Note 2) | SHIFT D RIGHT, $LSB(D) \rightarrow DF$ , $DF \rightarrow MSB(D)$     |
| SHIFT LEFT                            | SHL      | FE             | SHIFT D LEFT, $MSB(D) \rightarrow DF$ , $0 \rightarrow LSB(D)$       |
| SHIFT LEFT WITH CARRY                 | SHLC     | 7E<br>(Note 2) | SHIFT D LEFT, $MSB(D) \rightarrow DF$ , $DF \rightarrow LSB(D)$      |
| RING SHIFT LEFT                       | RSHL     | 7E<br>(Note 2) | SHIFT D LEFT, $MSB(D) \rightarrow DF$ , $DF \rightarrow LSB(D)$      |
| <b>ARITHMETIC OPERATIONS (Note 1)</b> |          |                |  |
| ADD                                   | ADD      | F4             | $M(R(X)) + D \rightarrow DF$ , D                                     |
| ADD IMMEDIATE                         | ADI      | FC             | $M(R(P)) + D \rightarrow DF$ , D; $R(P) + 1 \rightarrow R(P)$        |
| ADD WITH CARRY                        | ADC      | 74             | $M(R(X)) + D + DF \rightarrow DF$ , D                                |
| ADD WITH CARRY, IMMEDIATE             | ADCI     | 7C             | $M(R(P)) + D + DF \rightarrow DF$ , D; $R(P) + 1 \rightarrow R(P)$   |
| SUBTRACT D                            | SD       | F5             | $M(R(X)) - D \rightarrow DF$ , D                                     |
| SUBTRACT D IMMEDIATE                  | SDI      | FD             | $M(R(P)) - D \rightarrow DF$ , D; $R(P) + 1 \rightarrow R(P)$        |
| SUBTRACT D WITH BORROW                | SDB      | 75             | $M(R(X)) - D - (\text{NOT } DF) \rightarrow DF$ , D                  |

**CDP1802A, CDP1802AC, CDP1802BC**

**TABLE 1. INSTRUCTION SUMMARY (SEE NOTES) (Continued)**

| INSTRUCTION   | MNEMONIC | OP CODE        | OPERATION  |
|---|----------|----------------|--|
| SUBTRACT D WITH BORROW, IMMEDIATE                     | SDBI     | 7D             | M(R(P)) - D - (Not DF) → DF, D; R(P) + 1 → R(P)                          |
| SUBTRACT MEMORY                                       | SM       | F7             | D-M(R(X)) → DF, D  |
| SUBTRACT MEMORY IMMEDIATE                             | SMI      | FF             | D-M(R(P)) → DF, D; R(P) + 1 → R(P)                                       |
| SUBTRACT MEMORY WITH BORROW                           | SMB      | 77             | D-M(R(X))-(NOT DF) → DF, D   |
| SUBTRACT MEMORY WITH BORROW, IMMEDIATE                | SMBI     | 7F             | D-M(R(P))-(NOT DF) → DF, D; R(P) + 1 → R(P)                              |
| <b>BRANCH INSTRUCTIONS - SHORT BRANCH</b>             |          |                |  |
| SHORT BRANCH  | BR       | 30             | M(R(P)) → R(P).0   |
| NO SHORT BRANCH (See SKP)                             | NBR      | 38<br>(Note 2) | R(P) + 1 → R(P)  |
| SHORT BRANCH IF D = 0                                 | BZ       | 32             | IF D = 0, M(R(P)) → R(P).0, ELSE R(P) + 1 → R(P)                         |
| SHORT BRANCH IF D NOT 0                               | BNZ      | 3A             | IF D NOT 0, M(R(P)) → R(P).0, ELSE R(P) + 1 → R(P)                       |
| SHORT BRANCH IF DF = 1                                | BDF      | 33<br>(Note 2) | IF DF = 1, M(R(P)) → R(P).0, ELSE R(P) + 1 → R(P)                        |
| SHORT BRANCH IF POS OR ZERO                           | BPZ      |                |  |
| SHORT BRANCH IF EQUAL OR GREATER                      | BGE      |                |  |
| SHORT BRANCH IF DF = 0                                | BNF      | 3B<br>(Note 2) | IF DF = 0, M(R(P)) → R(P).0, ELSE R(P) + 1 → R(P)                        |
| SHORT BRANCH IF MINUS                                 | BM       |                |  |
| SHORT BRANCH IF LESS                                  | BL       |                |  |
| SHORT BRANCH IF Q = 1                                 | BQ       | 31             | IF Q = 1, M(R(P)) → R(P).0, ELSE R(P) + 1 → R(P)                         |
| SHORT BRANCH IF Q = 0                                 | BNQ      | 39             | IF Q = 0, M(R(P)) → R(P).0, ELSE R(P) + 1 → R(P)                         |
| SHORT BRANCH IF EF1 = 1 ( $\overline{EF1} = V_{SS}$ ) | B1       | 34             | IF EF1 = 1, M(R(P)) → R(P).0, ELSE R(P) + 1 → R(P)                       |
| SHORT BRANCH IF EF1 = 0 ( $\overline{EF1} = V_{CC}$ ) | BN1      | 3C             | IF EF1 = 0, M(R(P)) → R(P).0, ELSE R(P) + 1 → R(P)                       |
| SHORT BRANCH IF EF2 = 1 ( $\overline{EF2} = V_{SS}$ ) | B2       | 35             | IF EF2 = 1, M(R(P)) → R(P).0, ELSE R(P) + 1 → R(P)                       |
| SHORT BRANCH IF EF2 = 0 ( $\overline{EF2} = V_{CC}$ ) | BN2      | 3D             | IF EF2 = 0, M(R(P)) → R(P).0, ELSE R(P) + 1 → R(P)                       |
| SHORT BRANCH IF EF3 = 1 ( $\overline{EF3} = V_{SS}$ ) | B3       | 36             | IF EF3 = 1, M(R(P)) → R(P).0, ELSE R(P) + 1 → R(P)                       |
| SHORT BRANCH IF EF3 = 0 ( $\overline{EF3} = V_{CC}$ ) | BN3      | 3E             | IF EF3 = 0, M(R(P)) → R(P).0, ELSE R(P) + 1 → R(P)                       |
| SHORT BRANCH IF EF4 = 1 ( $\overline{EF4} = V_{SS}$ ) | B4       | 37             | IF EF4 = 1, M(R(P)) → R(P).0, ELSE R(P) + 1 → R(P)                       |
| SHORT BRANCH IF EF4 = 0 ( $\overline{EF4} = V_{CC}$ ) | BN4      | 3F             | IF EF4 = 0, M(R(P)) → R(P).0, ELSE R(P) + 1 → R(P)                       |
| <b>BRANCH INSTRUCTIONS - LONG BRANCH</b>              |          |                |  |
| LONG BRANCH   | LBR      | C0             | M(R(P)) → R(P).1, M(R(P) + 1) → R(P).0                                   |
| NO LONG BRANCH (See LSKP)                             | NLBR     | C8<br>(Note 2) | R(P) = 2 → R(P)  |
| LONG BRANCH IF D = 0                                  | LBZ      | C2             | IF D = 0, M(R(P)) → R(P).1, M(R(P) + 1) → R(P).0, ELSE R(P) + 2 → R(P)   |
| LONG BRANCH IF D NOT 0                                | LBNZ     | CA             | IF D Not 0, M(R(P)) → R(P).1, M(R(P) + 1) → R(P).0, ELSE R(P) + 2 → R(P) |
| LONG BRANCH IF DF = 1                                 | LBDF     | C3             | IF DF = 1, M(R(P)) → R(P).1, M(R(P) + 1) → R(P).0, ELSE R(P) + 2 → R(P)  |
| LONG BRANCH IF DF = 0                                 | LBNF     | CB             | IF DF = 0, M(R(P)) → R(P).1, M(R(P) + 1) → R(P).0, ELSE R(P) + 2 → R(P)  |
| LONG BRANCH IF Q = 1                                  | LBQ      | C1             | IF Q = 1, M(R(P)) → R(P).1, M(R(P) + 1) → R(P).0, ELSE R(P) + 2 → R(P)   |

**CDP1802A, CDP1802AC, CDP1802BC**

**TABLE 1. INSTRUCTION SUMMARY (SEE NOTES) (Continued)**

| INSTRUCTION                         | MNEMONIC | OP CODE        | OPERATION  |
|-------------------------------------|----------|----------------|--|
| LONG BRANCH IF Q = 0                | LBNQ     | C9             | IF Q = 0, M(R(P)) → R(P).1, M(R(P) + 1) → R(P).0<br>ELSE R(P) + 2 → R(P) |
| <b>SKIP INSTRUCTIONS</b>            |          |                |  |
| SHORT SKIP (See NBR)                | SKP      | 38<br>(Note 2) | R(P) + 1 → R(P)  |
| LONG SKIP (See NLBR)                | LSKP     | C8<br>(Note 2) | R(P) + 2 → R(P)  |
| LONG SKIP IF D = 0                  | LSZ      | CE             | IF D = 0, R(P) + 2 → R(P), ELSE CONTINUE                                 |
| LONG SKIP IF D NOT 0                | LSNZ     | C6             | IF D Not 0, R(P) + 2 → R(P), ELSE CONTINUE                               |
| LONG SKIP IF DF = 1                 | LSDF     | CF             | IF DF = 1, R(P) + 2 → R(P), ELSE CONTINUE                                |
| LONG SKIP IF DF = 0                 | LSNF     | C7             | IF DF = 0, R(P) + 2 → R(P), ELSE CONTINUE                                |
| LONG SKIP IF Q = 1                  | LSQ      | CD             | IF Q = 1, R(P) + 2 → R(P), ELSE CONTINUE                                 |
| LONG SKIP IF Q = 0                  | LSNQ     | C5             | IF Q = 0, R(P) + 2 → R(P), ELSE CONTINUE                                 |
| LONG SKIP IF IE = 1                 | LSIE     | CC             | IF IE = 1, R(P) + 2 → R(P), ELSE CONTINUE                                |
| <b>CONTROL INSTRUCTIONS</b>         |          |                |  |
| IDLE                                | IDL      | 00<br>(Note 3) | WAIT FOR DMA OR INTERRUPT; M(R(0)) → BUS                                 |
| NO OPERATION                        | NOP      | C4             | CONTINUE   |
| SET P                               | SEP      | DN             | N → P  |
| SET X                               | SEX      | EN             | N → X  |
| SET Q                               | SEQ      | 7B             | 1 → Q  |
| RESET Q                             | REQ      | 7A             | 0 → Q  |
| SAVE                                | SAV      | 78             | T → M(R(X))  |
| PUSH X, P TO STACK                  | MARK     | 79             | (X, P) → T; (X, P) → M(R(2)), THEN P → X; R(2) - 1 → R(2)                |
| RETURN                              | RET      | 70             | M(R(X)) → (X, P); R(X) + 1 → R(X), 1 → IE                                |
| DISABLE                             | DIS      | 71             | M(R(X)) → (X, P); R(X) + 1 → R(X), 0 → IE                                |
| <b>INPUT - OUTPUT BYTE TRANSFER</b> |          |                |  |
| OUTPUT 1                            | OUT 1    | 61             | M(R(X)) → BUS; R(X) + 1 → R(X); N LINES = 1                              |
| OUTPUT 2                            | OUT 2    | 62             | M(R(X)) → BUS; R(X) + 1 → R(X); N LINES = 2                              |
| OUTPUT 3                            | OUT 3    | 63             | M(R(X)) → BUS; R(X) + 1 → R(X); N LINES = 3                              |
| OUTPUT 4                            | OUT 4    | 64             | M(R(X)) → BUS; R(X) + 1 → R(X); N LINES = 4                              |
| OUTPUT 5                            | OUT 5    | 65             | M(R(X)) → BUS; R(X) + 1 → R(X); N LINES = 5                              |
| OUTPUT 6                            | OUT 6    | 66             | M(R(X)) → BUS; R(X) + 1 → R(X); N LINES = 6                              |
| OUTPUT 7                            | OUT 7    | 67             | M(R(X)) → BUS; R(X) + 1 → R(X); N LINES = 7                              |
| INPUT 1                             | INP 1    | 69             | BUS → M(R(X)); BUS → D; N LINES = 1                                      |
| INPUT 2                             | INP 2    | 6A             | BUS → M(R(X)); BUS → D; N LINES = 2                                      |
| INPUT 3                             | INP 3    | 6B             | BUS → M(R(X)); BUS → D; N LINES = 3                                      |
| INPUT 4                             | INP 4    | 6C             | BUS → M(R(X)); BUS → D; N LINES = 4                                      |
| INPUT 5                             | INP 5    | 6D             | BUS → M(R(X)); BUS → D; N LINES = 5                                      |
| INPUT 6                             | INP 6    | 6E             | BUS → M(R(X)); BUS → D; N LINES = 6                                      |
| INPUT 7                             | INP 7    | 6F             | BUS → M(R(X)); BUS → D; N LINES = 7                                      |

**CDP1802A, CDP1802AC, CDP1802BC**

**TABLE 1. INSTRUCTION SUMMARY (SEE NOTES) (Continued)**

| INSTRUCTION | MNEMONIC | OP<br>CODE | OPERATION |
|-------------|----------|------------|-----------|
|-------------|----------|------------|-----------|

NOTES: (For Table 1)

- The arithmetic operations and the shift instructions are the only instructions that can alter the DF.

After an add instruction:

DF = 1 denotes a carry has occurred

DF = 0 Denotes a carry has not occurred

After a subtract instruction:

DF = 1 denotes no borrow. D is a true positive number

DF = 0 denotes a borrow. D is two's complement

The syntax “-(not DF)” denotes the subtraction of the borrow.

- This instruction is associated with more than one mnemonic. Each mnemonic is individually listed.

- An idle instruction initiates a repeating S1 cycle. The processor will continue to idle until an I/O request (INTERRUPT, DMA-IN, or DMA-OUT) is activated. When the request is acknowledged, the idle cycle is terminated and the I/O request is serviced, and then normal operation is resumed.

- Long-Branch, Long-Skip and No Op instructions require three cycles to complete (1 fetch + 2 execute).

Long-Branch instructions are three bytes long. The first byte specifies the condition to be tested; and the second and third byte, the branching address.

The long-branch instructions can:

- Branch unconditionally
- Test for D = 0 or D ≠ 0
- Test for DF = 0 or DF = 1
- Test for Q = 0 or Q = 1
- Effect an unconditional no branch

If the tested condition is met, then branching takes place; the branching address bytes are loaded in the high-and-low order bytes of the current program counter, respectively. This operation effects a branch to any memory location.

If the tested condition is not met, the branching address bytes are skipped over, and the next instruction in sequence is fetched and executed. This operation is taken for the case of unconditional no branch (NLBR).

- The short-branch instructions are two bytes long. The first byte specifies the condition to be tested, and the second specifies the branching address.

The short branch instruction can:

- Branch unconditionally
- Test for D = 0 or D ≠ 0
- Test for DF = 0 or DF = 1
- Test for Q = 0 or Q = 1
- Test the status (1 or 0) of the four EF flags
- Effect an unconditional no branch

If the tested condition is met, then branching takes place; the branching address byte is loaded into the low-order byte position of the current program counter. This effects a branch within the current 256-byte page of the memory, i.e., the page which holds the branching address. If the tested condition is not met, the branching address byte is skipped over, and the next instruction in sequence is fetched and executed. This same action is taken in the case of unconditional no branch (NBR).

- The skip instructions are one byte long. There is one Unconditional Short-Skip (SKP) and eight Long-Skip instructions.

The Unconditional Short-Skip instruction takes 2 cycles to complete (1 fetch + 1 execute). Its action is to skip over the byte following it. Then the next instruction in sequence is fetched and executed. This SKP instruction is identical to the unconditional no-branch instruction (NBR) except that the skipped-over byte is not considered part of the program.

The Long-Skip instructions take three cycles to complete (1 fetch + 2 execute).

They can:

- Skip unconditionally
- Test for D = 0 or D ≠ 0
- Test for DF = 0 or DF = 1
- Test for Q = 0 or Q = 1
- Test for IE = 1

If the tested condition is met, then Long Skip takes place; the current program counter is incremented twice. Thus two bytes are skipped over, and the next instruction in sequence is fetched and executed. If the tested condition is not met, then no action is taken. Execution is continued by fetching the next instruction in sequence.



**CDP1802A, CDP1802AC, CDP1802BC**

**TABLE 2. CONDITIONS ON DATA BUS AND MEMORY ADDRESS LINES DURING ALL MACHINE STATES**

| STATE | I   | N       | SYMBOL                                | OPERATION                                   | DATA BUS | MEMORY ADDRESS | MRD | MWR    | N LINES | NOTES     |
|-------|-----|---------|---------------------------------------|---|----------|----------------|-----|--------|---------|-----------|
| S1    |     |         | RESET                                 | 0 → I, N, Q, X, P; 1 → IE                   | 00       | XXXX           | 1   | 1      | 0       | 1         |
|       |     |         | Initialize, Not Programmer Accessible | 0000 → R                                    | 00       | XXXX           | 1   | 1      | 0       | 2         |
| S0    |     |         | FETCH                                 | MRP → I, N; RP + 1 → RP                     | MRP      | RP             | 0   | 1      | 0       | 3         |
| S1    | 0   | 0       | IDL                                   | IDLE  | MR0      | RO             | 0   | 1      | 0       | 4, Fig. 8 |
|       | 0   | 1 - F   | LDN                                   | MRN → D                                     | MRN      | RN             | 0   | 1      | 0       | Fig. 8    |
|       | 1   | 0 - F   | INC                                   | RN + 1 → RN                                 | Float    | RN             | 1   | 1      | 0       | Fig. 6    |
|       | 2   | 0 - F   | DEC                                   | RN - 1 → RN                                 | Float    | RN             | 1   | 1      | 0       | Fig. 6    |
|       | 3   | 0 - F   | Short Branch                          | Taken: MRP → RP.0<br>Not Taken; RP + 1 → RP | MRP      | RP             | 0   | 1      | 0       | Fig. 8    |
|       | 4   | 0 - F   | LDA                                   | MRN → D; RN + 1 → RN                        | MRN      | RN             | 0   | 1      | 0       | Fig. 8    |
|       | 5   | 0 - F   | STR                                   | D → MRN                                     | D        | RN             | 1   | 0      | 0       | Fig. 7    |
|       | 6   | 0       | IRX                                   | RX + 1 → RX                                 | MRX      | RX             | 0   | 1      | 0       | Fig. 7    |
|       | 6   | 1       | OUT 1                                 | MRX → BUS; RX + 1 → RX                      | MRX      | RX             | 0   | 1      | 1       | Fig. 11   |
|       |     | 2       | OUT 2                                 |   |          |                |     |        | 2       | Fig. 11   |
|       |     | 3       | OUT 3                                 |   |          |                |     |        | 3       | Fig. 11   |
|       |     | 4       | OUT 4                                 |   |          |                |     |        | 4       | Fig. 11   |
|       |     | 5       | OUT 5                                 |   |          |                |     |        | 5       | Fig. 11   |
|       |     | 6       | OUT 6                                 |   |          |                |     |        | 6       | Fig. 11   |
|       |     | 7       | OUT 7                                 |   |          |                |     |        | 7       | Fig. 11   |
|       | 9   | INP 1   | BUS → MRX, D                          | Data from I/O Device                        | RX       | 1              | 0   | 1      | Fig. 10 |           |
|       |     | A       |                                       |   |          |                |     | INP 2  | 2       | Fig. 10   |
|       |     | B       |                                       |   |          |                |     | INP 3  | 3       | Fig. 10   |
|       |     | C       |                                       |   |          |                |     | INP 4  | 4       | Fig. 10   |
|       |     | D       |                                       |   |          |                |     | INP5   | 5       | Fig. 10   |
|       |     | E       |                                       |   |          |                |     | INP6   | 6       | Fig. 10   |
|       |     | F       |                                       |   |          |                |     | INP7   | 7       | Fig. 10   |
|       | 7   | 0       | RET                                   | MRX → (X, P); RX + 1 → RX;<br>1 → IE        | MRX      | RX             | 0   | 1      | 0       | Fig. 8    |
| 1     |     | DIS     | MRX → (X, P); RX + 1 → RX;<br>0 → IE  | MRX   | RX       | 0              | 1   | 0      | Fig. 8  |           |
| 2     |     | LDXA    | MRX → D; RX + 1 → RX                  | MRX   | RX       | 0              | 1   | 0      | Fig. 8  |           |
| 3     |     | STXD    | D → MRX; RX - 1 → RX                  | D   | RX       | 1              | 0   | 0      | Fig. 7  |           |
| 4     |     | ADC     | MRX + D + DF → DF, D                  | MRX   | RX       | 0              | 1   | 0      | Fig. 8  |           |
| 5     |     | SDB     | MRX - D - DFN → DF, D                 | MRX   | RX       | 0              | 1   | 0      | Fig. 8  |           |
| 6     |     | SHRC    | LSB(D) → DF; DF → MSB(D)              | Float                                       | RX       | 1              | 1   | 0      | Fig. 6  |           |
| 7     |     | SMB     | D - MRX - DFN → DF, D                 | MRX   | RX       | 0              | 1   | 0      | Fig. 8  |           |
| 8     | SAV | T → MRX | T                                     | RX  | 1        | 0              | 0   | Fig. 7 |         |           |

**CDP1802A, CDP1802AC, CDP1802BC**

**TABLE 2. CONDITIONS ON DATA BUS AND MEMORY ADDRESS LINES DURING ALL MACHINE STATES (Continued)**

| STATE | I     | N                               | SYMBOL                     | OPERATION                              | DATA BUS  | MEMORY ADDRESS | $\overline{MRD}$ | $\overline{MWR}$ | N LINES | NOTES  |        |
|-------|-------|---------------------------------|----------------------------|--|---|----------------|------------------|------------------|---------|--------|--------|
| S1    | 7     | 9                               | MARK                       | (X, P) → T, MR2; P → X;<br>R2 - 1 → R2 | T   | R2             | 1                | 0                | 0       | Fig. 7 |        |
|       |       | A                               | REQ                        | 0 → Q                                  | Float   | RP             | 1                | 1                | 0       | Fig. 6 |        |
|       |       | B                               | SEQ                        | 1 → Q                                  | Float   | RP             | 1                | 1                | 0       | Fig. 6 |        |
|       |       | C                               | ADCI                       | MRP + D + DF → DF, D;<br>RP + 1        | MRP   | RP             | 0                | 1                | 0       | Fig. 8 |        |
|       |       | D                               | SDBI                       | MRP - D - DFN → DF, D;<br>RP + 1       | MRP   | RP             | 0                | 1                | 0       | Fig. 8 |        |
|       |       | E                               | SHLC                       | MSB(D) → DF; DF → LSB(D)               | Float   | RP             | 1                | 1                | 0       | Fig. 6 |        |
|       |       | F                               | SMBI                       | D - MRP - DFN → DF, D;<br>RP + 1       | MRP   | RP             | 0                | 1                | 0       | Fig. 8 |        |
|       | 8     | 0 - F                           | GLO                        | RN.0 → D                               | RN.0  | RN             | 1                | 1                | 0       | Fig. 6 |        |
|       | 9     | 0 - F                           | GHI                        | RN.1 → D                               | RN.1  | RN             | 1                | 1                | 0       | Fig. 6 |        |
|       | A     | 0 - F                           | PLO                        | D → RN.0                               | D   | RN             | 1                | 1                | 0       | Fig. 6 |        |
| B     | 0 - F | PHI                             | D → RN.1                   | D                                      | RN  | 1              | 1                | 0                | Fig. 6  |        |        |
| S1#1  | C     | 0 - 3,<br>8 - B                 | Long Branch                | Taken: MRP → B; RP + 1 → RP            | MRP   | RP             | 0                | 1                | 0       | Fig. 9 |        |
| #2    |       |                                 |                            | Taken: B → RP.1;<br>MRP → RP.0         | M(RP + 1)   | RP + 1         | 0                | 1                | 0       | Fig. 9 |        |
| S1#1  |       |                                 |                            | Not Taken: RP + 1 → RP                 | MRP   | RP             | 0                | 1                | 0       | Fig. 9 |        |
| #2    |       |                                 |                            | Not Taken: RP + 1 → RP                 | M(RP + 1)   | RP + 1         | 0                | 1                | 0       | Fig. 9 |        |
| S1#1  |       | 5<br>6<br>7<br>C<br>D<br>E<br>F | Long Skip                  | Taken: RP + 1 → RP                     | MRP   | RP             | 0                | 1                | 0       | Fig. 9 |        |
| #2    |       |                                 |                            | Taken: RP + 1 → RP                     | M(RP + 1)   | RP + 1         | 0                | 1                | 0       | Fig. 9 |        |
| S1#1  |       |                                 |                            | Not Taken: No Operation                | MRP   | RP             | 0                | 1                | 0       | Fig. 9 |        |
| #2    |       |                                 |                            | Not Taken: No Operation                | MRP   | RP             | 0                | 1                | 0       | Fig. 9 |        |
| S1#1  |       | 4                               | NOP                        | No Operation                           | MRP   | RP             | 0                | 1                | 0       | Fig. 9 |        |
| #2    |       |                                 |                            | No Operation                           | MRP   | RP             | 0                | 1                | 0       | Fig. 9 |        |
| S1    |       | D                               | 0 - F                      | SEP                                    | N → P   | NN             | RN               | 1                | 1       | 0      | Fig. 6 |
|       |       | E                               | 0 - F                      | SEX                                    | N → X   | NN             | RN               | 1                | 1       | 0      | Fig. 6 |
| S1    |       | F                               | 0                          | LDX                                    | MRX → D   | MRX            | RX               | 0                | 1       | 0      | Fig. 8 |
|       |       |                                 | 1<br>2<br>3<br>4<br>5<br>7 | OR<br>AND<br>XOR<br>ADD<br>SD<br>SM    | MRX OR D → D<br>MRX AND D → D<br>MRX XOR D → D<br>MRX + D → DF, D<br>MRX - D → DF, D<br>D - MRX → DF, D | MRX            | RX               | 0                | 1       | 0      | Fig. 8 |
|       |       |                                 | 6                          | SHR                                    | LSB(D) → DF; 0 → MSB(D)   | Float          | RX               | 1                | 1       | 0      | Fig. 6 |

**CDP1802A, CDP1802AC, CDP1802BC**

**TABLE 2. CONDITIONS ON DATA BUS AND MEMORY ADDRESS LINES DURING ALL MACHINE STATES (Continued)**

| STATE | I | N         | SYMBOL                  | OPERATION  | DATA BUS             | MEMORY ADDRESS | $\overline{MRD}$ | $\overline{MWR}$ | N LINES | NOTES      |
|-------|---|-----------|-------------------------|--|----------------------|----------------|------------------|------------------|---------|------------|
| S1    | F | 8         | LDI                     | MRP → D; RP + 1 → RP                               | MRP                  | RP             | 0                | 1                | 0       | Fig. 8     |
|       |   | 9         | ORI                     | MRP OR D → D; RP + 1 → RP                          |                      |                |                  |                  |         |            |
|       |   | A         | ANI                     | MRP AND D → D; RP + 1 → RP                         |                      |                |                  |                  |         |            |
|       |   | B         | XRI                     | MRP XOR D → D; RP + 1 → RP                         |                      |                |                  |                  |         |            |
|       |   | C         | ADI                     | MRP + D → DF, D; RP + 1 → RP                       |                      |                |                  |                  |         |            |
|       |   | D         | SDI                     | MRP - D → DF, D; RP + 1 → RP                       |                      |                |                  |                  |         |            |
|       |   | F         | SMI                     | D - MRP → DF, D; RP + 1 → RP                       |                      |                |                  |                  |         |            |
|       | E | SHL       | MSB(D) → DF; 0 → LSB(D) | Float  | RP                   | 1              | 1                | 0                | Fig. 6  |            |
| S2    |   | DMA IN    |                         | BUS → MR0; R0 + 1 → R0                             | Data from I/O Device | R0             | 1                | 0                | 0       | 6, Fig. 12 |
|       |   | DMAOUT    |                         | MR0 → BUS; R0 + 1 → R0                             | MR0                  | R0             | 0                | 1                | 0       | 6, Fig. 13 |
| S3    |   | INTERRUPT |                         | X, P → T; 0 → IE, 1 → P; 2 → X                     | Float                | RN             | 1                | 1                | 0       | Fig. 14    |
| S1    |   | LOAD      |                         | IDLE ( $\overline{CLEAR}$ , $\overline{WAIT}$ = 0) | M(R0 - 1)            | R0 - 1         | 0                | 1                | 0       | 5, Fig. 8  |

**NOTES:**

1. IE = 1, TPA, TPB suppressed, state = S1.
2. BUS = 0 for entire cycle.
3. Next state always S1.
4. Wait for DMA or INTERRUPT.
5. Suppress TPA, wait for DMA.
6. IN REQUEST has priority over OUT REQUEST.
7. See Timing Waveforms, Figure 5 through Figure 14 for machine cycles.

**Operating and Handling Considerations**

**Handling**

All inputs and outputs of Intersil CMOS devices have a network for electrostatic protection during handling.

**Operating**

**Operating Voltage** - During operation near the maximum supply voltage limit care should be taken to avoid or suppress power supply turn-on and turn-off transients, power supply ripple, or ground noise; any of these conditions must not cause  $V_{DD} - V_{SS}$  to exceed the absolute maximum rating.

**Input Signals** - To prevent damage to the input protection circuit, input signals should never be greater than  $V_{DD}$  nor less than  $V_{SS}$ . Input currents must not exceed 10mA even when the power supply is off.

**Unused Inputs** - A connection must be provided at every input terminal. All unused input terminals must be connected to either  $V_{DD}$  or  $V_{SS}$ , whichever is appropriate.

**Output Short Circuits** - Shorting of outputs to  $V_{DD}$  or  $V_{SS}$  may damage CMOS devices by exceeding the maximum device dissipation.

All Intersil semiconductor products are manufactured, assembled and tested under **ISO9000** quality systems certification.

*Intersil products are sold by description only. Intersil Corporation reserves the right to make changes in circuit design and/or specifications at any time without notice. Accordingly, the reader is cautioned to verify that data sheets are current before placing orders. Information furnished by Intersil is believed to be accurate and reliable. However, no responsibility is assumed by Intersil or its subsidiaries for its use; nor for any infringements of patents or other rights of third parties which may result from its use. No license is granted by implication or otherwise under any patent or patent rights of Intersil or its subsidiaries.*

For information regarding Intersil Corporation and its products, see web site <http://www.intersil.com>