

**CP/M<sup>®</sup>**

**OPERATING SYSTEM**

**MANUAL**

 **DIGITAL RESEARCH<sup>™</sup>**

**CP/M<sup>®</sup>**  
**OPERATING SYSTEM**  
**MANUAL**

 **DIGITAL RESEARCH<sup>™</sup>**  
P.O. Box 579  
Pacific Grove, California 93950

## **COPYRIGHT**

Copyright © 1976, 1977, 1978, 1979, and 1982 by Digital Research. All rights reserved. No part of this publication may be reproduced, transmitted, transcribed, stored in a retrieval system, or translated into any language or computer language, in any form or by any means, electronic, mechanical, magnetic, optical, chemical, manual or otherwise, without the prior written permission of Digital Research, Post Office Box 579, Pacific Grove, California 93950.

## **DISCLAIMER**

Digital Research makes no representations or warranties with respect to the contents hereof and specifically disclaims any implied warranties of merchantability or fitness for any particular purpose. Further, Digital Research reserves the right to revise this publication and to make changes from time to time in the content hereof without obligation of Digital Research to notify any person of such revision or changes.

## **TRADEMARKS**

CP/M is a registered trademark of Digital Research. MP/M, MAC, and SID are trademarks of Digital Research. Z-80 is a trademark of Zilog, Inc.

First Printing: July 1982

# CONTENTS

<b>1</b>	<b>CP/M FEATURES AND FACILITIES</b> .....	<b>1</b>
1.1	Introduction .....	1
1.2	Functional Description .....	3
1.2.1	General Command Structure .....	3
1.2.2	File References .....	3
1.3	Switching Disks .....	5
1.4	Built-in Commands.....	6
1.4.1	ERA.....	6
1.4.2	DIR .....	6
1.4.3	REN .....	7
1.4.4	SAVE .....	8
1.4.5	TYPE .....	8
1.4.6	USER .....	8
1.5	Line Editing and Output Control .....	9
1.6	Transient Commands .....	9
1.6.1	STAT .....	10
1.6.1	ASM .....	15
1.6.3	LOAD .....	16
1.6.4	PIP .....	17
1.6.5	ED .....	23
1.6.6	SYSGEN .....	24
1.6.7	SUBMIT .....	25
1.6.8	DUMP .....	27
1.6.9	MOVCPM .....	27
1.7	BDOS Error Messages .....	29
1.8	Operation of CP/M on the MDS .....	30
<b>2</b>	<b>ED</b> .....	<b>33</b>
2.1	Introduction to ED .....	33
2.1.1	ED Operation .....	33
2.1.2	Text Transfer Functions .....	35
2.1.3	Memory Buffer Organization .....	35
2.1.4	Line Numbers and ED Start Up .....	36
2.1.5	Memory Buffer Operation .....	37
2.1.6	Command Strings .....	38
2.1.7	Text Search and Alteration .....	39
2.1.8	Source Libraries .....	42
2.1.9	Repetitive Command Execution .....	42
2.2	ED Error Conditions .....	43
2.3	Control Characters and Commands .....	44

<b>3</b>	<b>CP/M ASSEMBLER</b> .....	47
3.1	Introduction .....	47
3.2	Program Format .....	48
3.3	Forming the Operand .....	49
3.3.1	Labels .....	50
3.3.2	Numeric Constants .....	50
3.3.3	Reserved Words .....	50
3.3.4	String Constants .....	51
3.3.5	Arithmetic and Logical Operators .....	52
3.3.6	Precedence of Operators .....	52
3.4	Assembler Directives .....	53
3.4.1	The ORG Directive .....	54
3.4.2	The END Directive .....	54
3.4.3	The EQU Directive .....	55
3.4.4	The SET Directive .....	55
3.4.5	The IF and ENDIF Directives .....	56
3.4.6	The DB Directive .....	57
3.4.7	The DW Directive .....	57
3.4.8	The DS Directive .....	57
3.5	Operation Codes .....	58
3.5.1	Jumps, Calls, and Returns .....	58
3.5.2	Immediate Operand Instructions .....	59
3.5.3	Increment and Decrement Instructions .....	60
3.5.4	Data Movement Instructions .....	60
3.5.5	Arithmetic Logic Unit Operations .....	61
3.5.6	Control Instructions .....	62
3.6	Error Messages .....	62
3.7	A Sample Session .....	63
<b>4</b>	<b>CP/M DYNAMIC DEBUGGING TOOL</b> .....	69
4.1	Introduction .....	69
4.2	DDT Commands .....	71
4.2.1	The A (Assembly) Command .....	71
4.2.2	The D (Display) Command .....	72
4.2.3	The F (Fill) Command .....	72
4.2.4	The G (Go) Command .....	72
4.2.5	The I (Input) Command .....	73
4.2.6	The L (List) Command .....	74
4.2.7	The M (Move) Command .....	74
4.2.8	The R (Read) Command .....	74
4.2.9	The S (Set) Command .....	75
4.2.10	The T (Trace) Command .....	75
4.2.11	The U (Untrace) Command .....	76
4.2.12	The X (Examine) Command .....	76
4.3	Implementation Notes .....	77
4.4	An Example .....	78
<b>5</b>	<b>CP/M 2 SYSTEM INTERFACE</b> .....	89
5.1	Introduction .....	89
5.2	Operating System Call Conventions .....	91
5.3	A Sample File-to-File Copy Program .....	110
5.4	A Sample File Dump Utility .....	113
5.5	A Sample Random Access Program .....	117
5.6	System Function Summary .....	124

<b>6</b>	<b>CP/M ALTERATION</b> .....	<b>127</b>
6.1	Introduction .....	127
6.2	First Level System Regeneration .....	128
6.3	Second Level System Generation .....	131
6.4	Sample GETSYS and PUTSYS Program .....	134
6.5	Diskette Organization .....	136
6.6	The BIOS Entry Points .....	137
6.7	A Sample BIOS .....	143
6.8	A Sample Cold Start Loader .....	143
6.9	Reserved Locations in Page Zero .....	144
6.10	Disk Parameter Tables .....	145
6.11	The DISKDEF Macro Library .....	148
6.12	Sector Blocking and Deblocking .....	152

## APPENDIXES

A	The MDS Basic I/O System (BIOS) .....	153
B	A Skeletal CBIOS .....	175
C	A Skeletal GETSYS/PUTSYS Program .....	187
D	The MDS-800 Cold Start Loader for CP/M 2 .....	191
E	A Skeletal Cold Start Loader .....	197
F	CP/M Disk Definition Library .....	201
G	Blocking and Deblocking Algorithms .....	209
H	Glossary .....	219
I	CP/M Messages .....	235

<b>INDEX</b> .....	<b>245</b>
--------------------	------------

## FIGURES

2.1	Overall ED Operation .....	34
2.2	Memory Buffer Organization .....	34
2.3	Logical Organization of Memory Buffer .....	36



# CP/M Features and Facilities

## 1.1 Introduction

CP/M is a monitor control program for microcomputer system development that uses floppy disks or Winchester hard disks for backup storage. Using a computer system based upon Intel's 8080 microcomputer, CP/M provides a general environment for program construction, storage, and editing, along with assembly and program check-out facilities. An important feature of CP/M is that it can be easily altered to execute with any computer configuration that uses an Intel 8080 (or Zilog Z-80) Central Processing Unit and has at least 20K bytes of main memory with up to 16 diskette drives. A detailed discussion of the modifications required for any particular hardware environment is given in Chapter 6. Although the standard Digital Research version operates on a single-density Intel MDS 800, several different hardware manufacturers support their own input-output drivers for CP/M.

The CP/M monitor provides rapid access to programs through a comprehensive file management package. The file subsystem supports a named file structure, allowing dynamic allocation of file space as well as sequential and random file access. Using this file system, a large number of programs can be stored in both source and machine-executable form.

CP/M 2 is a high-performance, single-console operating system that uses table-driven techniques to allow field reconfiguration to match a wide variety of disk capacities. All fundamental file restrictions are removed, maintaining upward compatibility from previous versions of release 1. Features of CP/M 2 include field specification of one to sixteen logical drives, each containing up to eight megabytes. Any particular file can reach the full drive size with the capability of expanding to thirty-two megabytes in future releases. The directory size can be field-configured to contain any reasonable number of entries, and each file is optionally tagged with read/only and system attributes. Users of CP/M 2 are physically separated by user numbers, with facilities for file copy operations from one user area to another. Powerful relative-record random access functions are present in CP/M 2 that provide direct access to any of the 65536 records of an eight-megabyte file.

CP/M also supports a powerful context editor, Intel-compatible assembler, and debugger subsystems. Optional software includes a powerful Intel-compatible macro assembler, symbolic debugger, along with various high-level languages. When coupled



with CP/M's Console Command Processor, the resulting facilities equal or excel similar large computer facilities.

CP/M is logically divided into several distinct parts:

BIOS	Basic I/O System (hardware-dependent)
BDOS	Basic Disk Operating System
CCP	Console Command Processor
TPA	Transient Program Area

The BIOS provides the primitive operations necessary to access the diskette drives and to interface standard peripherals (teletype, CRT, paper tape reader/punch, and user-defined peripherals). They can be tailored by the user for any particular hardware environment by "patching" this portion of CP/M. The BDOS provides disk management by controlling one or more disk drives containing independent file directories. The BDOS implements disk allocation strategies that provide fully dynamic file construction while minimizing head movement across the disk during access. The BDOS has entry points that include the following primitive operations, which can be programmatically accessed:

SEARCH	Look for a particular disk file by name.
OPEN	Open a file for further operations.
CLOSE	Close a file after processing.
RENAME	Change the name of a particular file.
READ	Read a record from a particular file.
WRITE	Write a record to a particular file.
SELECT	Select a particular disk drive for further operations.

The CCP provides a symbolic interface between the user's console and the remainder of the CP/M system. The CCP reads the console device and processes commands, which include listing the file directory, printing the contents of files, and controlling the operation of transient programs, such as assemblers, editors, and debuggers. The standard commands that are available in the CCP are listed in Section 1.2.1.

The last segment of CP/M is the area called the Transient Program Area (TPA). The TPA holds programs that are loaded from the disk under command of the CCP. During program editing, for example, the TPA holds the CP/M text editor machine code and data areas. Similarly, programs created under CP/M can be checked out by loading and executing these programs in the TPA.

Any or all of the CP/M component subsystems can be "overlaid" by an executing program. That is, once a user's program is loaded into the TPA, the CCP, BDOS, and BIOS areas can be used as the program's data area. A "bootstrap" loader is programmatically accessible whenever the BIOS portion is not overlaid; thus, the user program need only branch to the bootstrap loader at the end of execution and the complete CP/M monitor is reloaded from disk.

The CP/M operating system is partitioned into distinct modules, including the BIOS portion that defines the hardware environment in which CP/M is executing. Thus, the standard system is easily modified to any nonstandard environment by changing the peripheral drivers to handle the custom system.

## 1.2 Functional Description

The user interacts with CP/M primarily through the CCP, which reads and interprets commands entered through the console. In general, the CCP addresses one of several disks that are on-line (the standard system addresses up to sixteen different disk drives). These disk drives are labeled A through P. A disk is "logged in" if the CCP is currently addressing the disk. To clearly indicate which disk is the currently logged disk, the CCP always prompts the operator with the disk name followed by the symbol ">" indicating that the CCP is ready for another command. Upon initial start-up, the CP/M system is brought in from disk A, and the CCP displays the message

```
CP/M VER m.m
```

where m.m is the CP/M version number. All CP/M systems are initially set to operate in a 20K memory space, but can be easily reconfigured to fit any memory size on the host system (see Section 1.6.9). Following system sign-on, CP/M automatically logs in disk A, prompts the user with the symbol "A>" (indicating that CP/M is currently addressing disk "A"), and waits for a command. The commands are implemented at two levels: built-in commands and transient commands.

### 1.2.1 General Command Structure

Built-in commands are a part of the CCP program itself, while transient commands are loaded into the TPA from disk and executed. The built-in commands are

ERA	Erase specified files.
DIR	List file names in the directory.
REN	Rename the specified file.
SAVE	Save memory contents in a file.
TYPE	Type the contents of a file on the logged disk.

*USER*

Most of the commands reference a particular file or group of files. The form of a file reference is specified below.

### 1.2.2 File References

A file reference identifies a particular file or group of files on a particular disk attached to CP/M. These file references are either "unambiguous" (ufn) or "ambiguous" (afn). An unambiguous file reference uniquely identifies a single file, while an ambiguous file reference is satisfied by a number of different files.

File references consist of two parts: the primary filename and the filetype. Although the filetype is optional, it usually is generic; that is, the filetype "ASM," for example, is used to denote that the file is an assembly language source file, while the primary filename distinguishes each particular source file. The two names are separated by a ".", as shown below:

```
filename.typ
```

where filename is the primary filename of eight characters or less, and typ is the filetype of no more than three characters. As mentioned above, the name

filename

is also allowed and is equivalent to a filetype consisting of three blanks. The characters used in specifying an unambiguous file reference cannot contain any of the special characters

< > . , ; : = ? \* [ ] \_ % | ( ) / \

while all alphanumerics and remaining special characters are allowed.

An ambiguous file reference is used for directory search and pattern matching. The form of an ambiguous file reference is similar to an unambiguous reference, except the symbol "?" can be interspersed throughout the primary and secondary names. In various commands throughout CP/M, the "?" symbol matches any character of a file name in the "?" position. Thus, the ambiguous reference

X?Z.C?M

is satisfied by the unambiguous file names

XYZ.COM

and

X3Z.CAM

Note that the ambiguous reference

\*.\*

is equivalent to the ambiguous file reference

?????????.???

while

filename.\*

and

\*.typ

are abbreviations for

filename.???

and

?????????.typ

respectively. As an example,

```
A>DIR *.*
```

is interpreted by the CCP as a command to list the names of all disk files in the directory, while

```
A>DIR X.Y
```

searches only for a file by the name X.Y. Similarly, the command

```
A>DIR X?Y.C?M
```

causes a search for all (unambiguous) file names on the disk that satisfy this ambiguous reference.

The following file names are valid unambiguous file references:

X	XYZ	GAMMA
X.Y	XYZ.COM	GAMMA.1

As an added convenience, the programmer can generally specify the disk drive name along with the file name. In this case, the drive name is given as a letter A through P followed by a colon (:). The specified drive is then "logged in" before the file operation occurs. Thus, the following are valid file names with disk name prefixes:

A:X.Y	B:XYZ	C:GAMMA
P:XYZ.COM	B:X.A?M	C:*.ASM

All alphabetic lower case letters in file and drive names are translated to upper case when they are processed by the CCP.

## 1.3 Switching Disks

The operator can switch the currently logged disk by typing the disk drive name (A through P) followed by a colon (:) when the CCP is waiting for console input. Thus, the sequence of prompts and commands below can occur after the CP/M system is loaded from disk A:

```
CP/M VER 2.2
A>DIR                               List all files on disk A.
A: SAMPLE ASM SAMPLE PRN
A>B:                                 Switch to disk B.
B>DIR *.ASM                          List all "ASM" files on B.
B: DUMP ASM FILES ASM
B>A:                                 Switch back to A.
```

## 1.4 Built-in Commands

The file and device reference forms described can now be used to fully specify the structure of the built-in commands. The user should assume the following abbreviations in the description below:

ufn	unambiguous file reference
afn	ambiguous file reference

Recall that the CCP always translates lower case characters to upper case characters internally. Thus, lower case alphabets are treated as if they are upper case in command names and file references.

### 1.4.1 ERA afn

The ERA (erase) command removes files from the currently logged in disk (i.e., the disk name currently prompted by CP/M preceding the ">"). The files that are erased are those that satisfy the ambiguous file reference afn. The following examples illustrate the use of ERA:

ERA X.Y	The file named X.Y on the currently logged disk is removed from the disk directory and the space is returned.
ERA X.*	All files with primary name X are removed from the current disk.
ERA *.ASM	All files with secondary name ASM are removed from the current disk.
ERA X?Y.C?M	All files on the current disk that satisfy the ambiguous reference X?Y.C?M are deleted.
ERA *.*	Erase all files on the current disk (in this case the CCP prompts the console with the message ALL FILES (Y/N)? that requires a Y response before files are actually removed).
ERA B:*.PRN	All files on drive B that satisfy the ambiguous reference ???????.PRN are deleted, independently of the currently logged disk.

### 1.4.2 DIR afn

The DIR (directory) command causes the names of all files that satisfy the ambiguous file name afn to be listed at the console device. As a special case, the command

DIR

lists the files on the currently logged disk (the command "DIR" is equivalent to the command "DIR \*.\*"). Valid DIR commands are

```
DIR X.Y
DIR X?Z.C?M
DIR ??Y
```

Similar to other CCP commands, the afn can be preceded by a drive name. The following DIR commands cause the selected drive to be addressed before the directory search takes place.

```
DIR B:
DIR B:X.Y
DIR B:*.A?M
```

If no files on the selected diskette satisfy the directory request, the message "NO FILE" is typed at the console.

### 1.4.3 REN ufn1=ufn2

The REN (rename) command allows the user to change the names of files on disk. The file satisfying ufn2 is changed to ufn1. The currently logged disk is assumed to contain the file to rename (ufn2). The user can also type a left-directed arrow instead of the equal sign if the console supports this graphic character. Examples of the REN command are

```
REN X.Y=Q.R           The file Q.R is changed to X.Y.
REN XYZ.COM=XYZ.XXX   The file XYZ.XXX is changed to XYZ.COM.
```

The operator precedes either ufn1 or ufn2 (or both) by an optional drive address. If ufn1 is preceded by a drive name, then ufn2 is assumed to exist on the same drive. Similarly, if ufn2 is preceded by a drive name, then ufn1 is assumed to exist on that drive as well. The same drive must be specified in both cases if both ufn1 and ufn2 are preceded by drive names. The REN commands below illustrate this format.

```
REN A:X.ASM=Y.ASM     The file Y.ASM is changed to X.ASM on drive
                        A.
REN B:ZAP.BAS=ZOT.BAS The file ZOT.BAS is changed to ZAP.BAS on
                        drive B.
REN B:A.ASM=B:A.BAK   The file A.BAK is renamed to A.ASM on drive
                        B.
```

If ufn1 is already present, the REN command will respond with the error "FILE EXISTS" and not perform the change. If ufn2 does not exist on the specified diskette, the message "NO FILE" is printed at the console.

## 1.4.4 SAVE n ufn

The SAVE command places *n* pages (256-byte blocks) onto disk from the TPA and names this file *ufn*. In the CP/M distribution system, the TPA starts at 100H (hexadecimal) which is the second page of memory. The SAVE command must specify 2 pages of memory if the user's program occupies the area from 100H through 2FFH. The machine code file can be subsequently loaded and executed. Examples are

SAVE 3 X.COM	Copies 100H through 3FFH to X.COM.
SAVE 40 Q	Copies 100H through 28FFH to Q (note that 28 is the page count in 28FFH, and that 28H = 2*16+8 = 40 decimal).
SAVE 4 X.Y	Copies 100H through 4FFH to X.Y.

The SAVE command can also specify a disk drive in the *ufn* portion of the command, as shown below.

SAVE 10 B:ZOT.COM	Copies 10 pages (100H through 0AFFH) to the file ZOT.COM on drive B.
-------------------	--

## 1.4.5 TYPE ufn

The TYPE command displays the contents of the ASCII source file *ufn* on the currently logged disk at the console device. Valid TYPE commands are

TYPE X.Y  
TYPE X.PLM  
TYPE XXX

The TYPE command expands tabs (ct-I characters), assuming tab positions are set at every eighth column. The *ufn* can also reference a drive name.

TYPE B:X.PRN	The file X.PRN from drive B is displayed.
--------------	---

## 1.4.6 USER n

The USER command allows maintenance of separate files in the same directory and takes the form

USER *n*

where *n* is an integer value in the range 0 to 15. On cold start, the operator is automatically "logged" into user area number 0, which is compatible with standard CP/M 1 directories. The operator may issue the USER command at any time to move to another logical area within the same directory. Drives that are logged-in while addressing one user number are automatically active when the operator moves to another; a user number is simply a prefix that accesses particular directory entries on the active disks.

The active user number is maintained until changed by a subsequent USER command, or until a cold start when user 0 is again assumed.

## 1.5 Line Editing and Output Control

The CCP allows certain line editing functions while typing command lines.

ctl-C	CP/M system reboot when typed at start of line.
ctl-E	Physical end of line: carriage is returned, but line is not sent until the carriage return key is depressed.
ctl-H	Backspace one character position.
ctl-J	Terminate current input (line feed).
ctl-M	Terminate current input (carriage return).
ctl-R	Retype current command line: types a "clean line" following character deletion with rubouts.
ctl-U	Delete the entire line typed at the console.
ctl-X	Same as ctl-U.
ctl-Z	End input from the console (used in PIP and ED).
rub/del	Delete and echo the last character typed at the console.

The control functions ctl-P and ctl-S affect console output.

ctl-P	Copy all subsequent console output to the currently assigned list device (see Section 1.6.1). Output is sent to the list device and the console device until the next ctl-P is typed.
ctl-S	Stop the console output temporarily. Program execution and output continue when the next character is typed at the console (e.g., another ctl-S). This feature stops output on high speed consoles, such as CRT's, in order to view a segment of output before continuing.

The ctl-key sequences are obtained by depressing the control and letter keys simultaneously. Further, CCP command lines are generally up to 255 characters in length; they are not acted upon until the carriage return key is typed.

## 1.6 Transient Commands

Transient commands are loaded from the currently logged disk and executed in the TPA. The transient commands for execution under the CCP are below. Additional functions are easily defined by the user (see Section 1.6.3).

STAT	List the number of bytes of storage remaining on the currently logged disk, provide statistical information about particular files, and display or alter device assignment.
ASM	Load the CP/M assembler and assemble the specified program from disk.
LOAD	Load the file in Intel "HEX" machine code format and produce a file in machine executable form that can be loaded into the TPA (this loaded program becomes a new command under the CCP).
DDT	Load the CP/M debugger into TPA and start execution.



PIP	Load the Peripheral Interchange Program for subsequent disk file and peripheral transfer operations.
ED	Load and execute the CP/M text editor program.
SYSGEN	Create a new CP/M system diskette.
SUBMIT	Submit a file of commands for batch processing.
DUMP	Dump the contents of a file in hex.
MOVCPM	Regenerate the CP/M system for a particular memory size.

Transient commands are specified in the same manner as built-in commands, and additional commands are easily defined by the user. For convenience, the transient command can be preceded by a drive name that causes the transient to be loaded from the specified drive into the TPA for execution. Thus, the command

B:STAT

causes CP/M to temporarily "log in" drive B for the source of the STAT transient, and then return to the original logged disk for subsequent processing.

The basic transient commands are listed in detail below.

### 1.6.1 STAT

The STAT command provides general statistical information about file storage and device assignment. It is initiated by typing one of the following forms:

STAT

STAT "command line"

Special forms of the "command line" allow the current device assignment to be examined and altered. The various command lines that can be specified are shown, with an explanation of each form to the right.

STAT

If the user types an empty command line, the STAT transient calculates the storage remaining on all active drives, and prints a message

d: R/W, SPACE: nnnK

or

d: R/O, SPACE: nnnK

for each active drive d:, where R/W indicates the drive can be read or written, and R/O indicates the drive is read only (a drive becomes R/O by explicitly setting it to read only, as shown below, or by inadvertently changing diskettes without performing a warm start). The space remaining on the diskette in drive d: is given in kilobytes by nnn.

STAT d: If a drive name is given, then the drive is selected before the storage is computed. Thus, the command "STAT B:" could be issued while logged into drive A, resulting in the message

BYTES REMAINING ON B: nnnK

STAT afn The command line can also specify a set of files to be scanned by STAT. The files that satisfy afn are listed in alphabetical order, with storage requirements for each file under the heading

RECS BYTS EX D:FILENAME.TYP

rrrr bbbK ee d:filename.typ

where rrrr is the number of 128-byte records allocated to the file, bbb is the number of kilobytes allocated to the file ( $bbb=rrrr*128/1024$ ), ee is the number of 16K extensions ( $ee=bbb/16$ ), d is the drive name containing the file (A...P), filename is the (up to) eight-character primary filename, and typ is the (up to) three-character filetype. After listing the individual files, the storage usage is summarized.

STAT d:afn The drive name can be given ahead of the afn. The specified drive is first selected, and the form "STAT afn" is executed.

STAT d:=R/O This form sets the drive given by d to read only, remaining in effect until the next warm or cold start takes place. When a disk is read only, the message

BDOS ERR ON d: READ ONLY

will appear if there is an attempt to write to the read-only disk d:. CP/M waits until a key is depressed before performing an automatic warm start (at which time the disk becomes R/W).

The STAT command allows control over the physical to logical device assignment (see the IOBYTE function described in Chapters 5 and 6). There are four logical peripheral devices that are, at any particular instant, each assigned one of several physical peripheral devices. The four logical devices are

CON: The system console device (used by CCP for communication with the operator)

RDR: The paper tape reader device

PUN: The paper tape punch device

LST: The output list device

The actual devices attached to any particular computer system are driven by subroutines in the BIOS portion of CP/M. Thus, the logical RDR: device, for example, could

actually be a high speed reader, teletype reader, or cassette tape. To allow some flexibility in device naming and assignment, several physical devices are defined below:

TTY:	Teletype device (slow speed console)
CRT:	Cathode ray tube device (high speed console)
BAT:	Batch processing (console is current RDR:, output goes to current LST: device)
UC1:	User-defined console
PTR:	Paper tape reader (high speed reader)
UR1:	User-defined reader #1
UR2:	User-defined reader #2
PTP:	Paper tape punch (high speed punch)
UP1:	User-defined punch #1
UP2:	User-defined punch #2
LPT:	Line printer
UL1:	User-defined list device #1

It is emphasized that the physical device names may or may not actually correspond to devices that the names imply. That is, the PTP: device may be implemented as a cassette write operation if the user wishes. The exact correspondence and driving subroutine is defined in the BIOS portion of CP/M. In the standard distribution version of CP/M, these devices correspond to their names on the MDS 800 development system.

The command

STAT VAL:

produces a summary of the available status commands, resulting in the output

```
Temp R/O Disk d:$R/O
Set Indicator: filename.typ $R/O $R/W $SYS $DIR
Disk Status: DSK: d:DSK
lobyte Assign:
```

which gives an instant summary of the possible STAT commands and shows the permissible logical-to-physical device assignments:

```
CON: = TTY: CRT: BAT: UC1:
RDR: = TTY: PTR: UR1: UR2:
PUN: = TTY: PTP: UP1: UP2:
LST: = TTY: CRT: LPT: UL1:
```

The logical device to the left takes any of the four physical assignments shown to the right. The current logical to physical mapping is displayed by typing the command

STAT DEV:

producing a list of each logical device to the left and the current corresponding physical device to the right. For example, the list might appear as

```
CON: = CRT:
RDR: = UR1:
PUN: = PTP:
LST: = TTY:
```

The current logical to physical device assignment is changed by typing a STAT command of the form

```
STAT ld1 = pd1, ld2 = pd2 , ... , ldn = pdn
```

where ld1 through ldn are logical device names and pd1 through pdn are compatible physical device names (i.e., ldi and pdi appear on the same line in the "VAL:" command shown above). Valid STAT commands that change the current logical to physical device assignments are

```
STAT CON:=CRT:
STAT PUN: = TTY:, LST:=LPT:, RDR:=TTY:
```

The command form

```
STAT d:filename.typ $$
```

where "d:" is an optional drive name and "filename.typ" is an unambiguous or ambiguous file name, produces the output display format

Size	Recs	Bytes	Ext	Acc
48	48	6k	1	R/O A:ED.COM
55	55	12k	1	R/O (A:PIP.COM)
65536	128	16k	2	R/W A:X.DAT

where the \$\$ parameter causes the "Size" field to be displayed. (Without the \$\$, the Size field is skipped, but the remaining fields are displayed.) The Size field lists the virtual file size in records, while the "Recs" field sums the number of virtual records in each extent. For files constructed sequentially, the Size and Recs fields are identical. The "Bytes" field lists the actual number of bytes allocated to the corresponding file. The minimum allocation unit is determined at configuration time; thus, the number of bytes corresponds to the record count plus the remaining unused space in the last allocated block for sequential files. Random access files are given data areas only when written, so the Bytes field contains the only accurate allocation figure. In the case of random access, the Size field gives the logical end-of-file record position and the Recs field counts the logical records of each extent. (Each of these extents, however, may contain unallocated "holes" even though they are added into the record count.) The "Ext" field counts the number of physical extents allocated to the file. The Ext count corresponds to the number of directory entries given to the file. Depending on allocation size, there can be up to 128K bytes (8 logical extents) directly addressed by a single directory entry. (In a special case, there are actually 256K bytes that can be directly addressed by a physical extent.)

The Acc field gives the R/O or R/W file indicator that is changed using the commands shown. Similarly, the parentheses shown about the PIP.COM filename indicate that it

has the "system" indicator set, so that it will not be listed in DIR commands. The four command forms

```
STAT d:filename.typ $R/O
STAT d:filename.typ $R/W
STAT d:filename.typ $SYS
STAT d:filename.typ $DIR
```

set or reset various permanent file indicators. The R/O indicator places the file (or set of files) in a read-only status until changed by a subsequent STAT command. The R/O status is recorded in the directory with the file so that it remains R/O through intervening cold start operations. The R/W indicator places the file in a permanent read/write status. The SYS indicator attaches the system indicator to the file, while the DIR command removes the system indicator. The "filename.typ" may be ambiguous or unambiguous, but files whose attributes are changed are listed at the console when the change occurs. The drive name denoted by "d:" is optional.

When a file is marked R/O, subsequent attempts to erase or write into the file result in a terminal BDOS message

```
BDOS Err on d: File R/O
```

The BDOS waits for a console input before performing a subsequent warm start (a "return" is sufficient). The command form

```
STAT d:DSK:
```

lists the drive characteristics of the disk named by "d:" that is in the range A:, B:, ..., P:. The drive characteristics are listed in the format

```
d: Drive Characteristics
65536: 128 Byte Record Capacity
8192: Kilobyte Drive Capacity
128: 32 Byte Directory Entries
0: Checked Directory Entries
1024: Records/ Extent
128: Records/ Block
58: Sectors/ Track
2: Reserved Tracks
```

where "d:" is the selected drive, followed by the total record capacity (65536 is an eight-megabyte drive), followed by the total capacity listed in kilobytes. The directory size is listed next, followed by the "checked" entries. The number of checked entries is usually identical to the directory size for removable media, because this mechanism is used to detect changed media during CP/M operation without an intervening warm start. For fixed media, the number is usually zero, because the media are not changed without at least a cold or warm start. The number of records per extent determines the addressing capacity of each directory entry (1024 times 128 bytes, or 128K in the previous example). The number of records per block shows the basic allocation size (in the example, 128 records/block times 128 bytes per record, or 16K bytes per block). The listing is then followed by the number of physical sectors per track and the number of reserved tracks.

For logical drives that share the same physical disk, the number of reserved tracks can be quite large because this mechanism is used to skip lower-numbered disk areas allocated to other logical disks. The command form

**STAT DSK:**

produces a drive characteristics table for all currently active drives. The final STAT command form is

**STATUSR:**

which produces a list of the user numbers that have files on the currently addressed disk. The display format is

Active User: 0

Active Files: 0 1 3

where the first line lists the currently addressed user number, as set by the last CCP USER command, followed by a list of user numbers scanned from the current directory. In this case, the active user number is 0 (default at cold start), with three user numbers that have active files on the current disk. The operator can subsequently examine the directories of the other user numbers by logging-in with USER 1 or USER 3 commands, followed by a DIR command at the CCP level.

## 1.6.2 ASM ufn

The ASM command loads and executes the CP/M 8080 assembler. The ufn specifies a source file containing assembly language statements where the filetype is assumed to be ASM and is not specified. The following ASM commands are valid:

ASM X

ASM GAMMA

The two-pass assembler is automatically executed. Assembly errors that occur during the second pass are printed at the console.

The assembler produces a file

X.PRN

where X is the primary name specified in the ASM command. The PRN file contains a listing of the source program (with imbedded tab characters if present in the source program), along with the machine code generated for each statement and diagnostic error messages, if any. The PRN file is listed at the console using the TYPE command, or sent to a peripheral device using PIP (see Section 1.6.4). The user should note that the PRN file contains the original source program, augmented by miscellaneous assembly information in the leftmost 16 columns (program addresses and hexadecimal machine code, for example). The PRN file serves as a backup for the original source file. If the source file is accidentally removed or destroyed, the PRN file can be edited (see Chapter 2) by removing the leftmost 16 characters of each line. This is done by issuing a single editor "macro" command. The resulting file is identical to the original source file and can be renamed (REN) from PRN to ASM for subsequent editing and assembly. The file

X.HEX

is also produced, which contains 8080 machine language in Intel "HEX" format suitable for subsequent loading and execution (see Section 1.6.3). For complete details of CP/M's assembly language program, see Chapter 3.

The source file for assembly is taken from an alternate disk by prefixing the assembly language file name by a disk drive name. The command

**ASM B:ALPHA**

loads the assembler from the currently logged drive and processes the source program ALPHA.ASM on drive B. The HEX and PRN files are also placed on drive B in this case.

### **1.6.3 LOAD ufn**

The LOAD command reads the file ufn, which is assumed to contain "HEX" format machine code, and produces a memory image file that can subsequently be executed. The file name ufn is assumed to be of the form

**X.HEX**

and only the filename X need be specified in the command. The LOAD command creates a file named

**X.COM**

that marks it as containing machine executable code. The file is actually loaded into memory and executed when the user types the filename X immediately after the prompting character ">" printed by the CCP.

Generally the CCP reads the filename X following the prompting character and looks for a built-in function name. If no function name is found, the CCP searches the system disk directory for a file by the name

**X.COM**

If found, the machine code is loaded into the TPA, and the program executes. Thus, the user need only LOAD a hex file once; it can be subsequently executed any number of times by typing the primary name. In this way the user can "invent" new commands in the CCP. (Initialized disks contain the transient commands as COM files, which are deleted at the user's option.) The operation takes place on an alternate drive if the file name is prefixed by a drive name. Thus

**LOAD B:BETA**

brings the LOAD program into the TPA from the currently logged disk and operates upon drive B after execution begins.

The user should note that the BETA.HEX file must contain valid Intel format hexadecimal machine code records (as produced by the ASM program, for example) that begin at 100H of the TPA. The addresses in the hex records must be in ascending order; gaps in unfilled memory regions are filled with zeroes by the LOAD command as the hex records are read. Thus, LOAD must be used only for creating CP/M standard "COM" files that operate in the TPA. Programs that occupy regions of memory other than the TPA are loaded under DDT.

## 1.6.4 PIP

PIP is the CP/M Peripheral Interchange Program that implements the basic media conversion operations necessary to load, print, punch, copy, and combine disk files. The PIP program is initiated by typing one of the following forms:

- (1) PIP
- (2) PIP 'command line'

In both cases PIP is loaded into the TPA and executed. In form (1), PIP reads command lines directly from the console, prompted with the "" character, until an empty command line is typed (i.e., a single carriage return is issued by the operator). Each successive command line causes some media conversion to take place according to the rules shown below. Form (2) of the PIP command is equivalent to the first, except that the single command line given with the PIP command is automatically executed, and PIP terminates immediately with no further prompting of the console for input command lines. The form of each command line is

destination = source#1, source#2, ... , source#n

where "destination" is the file or peripheral device to receive the data and "source#1, ..., source#n" is a series of one or more files or devices that are copied from left to right to the destination.

When multiple files are given in the command line (i.e.,  $n > 1$ ), the individual files are assumed to contain ASCII characters, with an assumed CP/M end-of-file character (ctl-Z) at the end of each file (see the O parameter to override this assumption). Lower case ASCII alphabets are internally translated to upper case to be consistent with CP/M file and device name conventions. Finally, the total command line length cannot exceed 255 characters (ctl-E can be used to force a physical carriage return for lines that exceed the console width).

The destination and source elements are unambiguous references to CP/M source files with or without a preceding disk drive name. That is, any file can be referenced with a preceding drive name (A: through P:) that defines the particular drive where the file may be obtained or stored. When the drive name is not included, the currently logged disk is assumed. The destination file can also appear as one or more of the source files, in which case the source file is not altered until the entire concatenation is complete. If it already exists, the destination file is removed if the command line is properly formed (it is not removed if an error condition arises). The following command lines (with explanations to the right) are valid as input to PIP:

X=Y	Copy to file X from file Y, where X and Y are unambiguous file names; Y remains unchanged.
X=Y,Z	Concatenate files Y and Z and copy to file X, with Y and Z unchanged.
X.ASM=Y.ASM,Z.ASM,FIN.ASM	Create the file X.ASM from the concatenation of the Y, Z, and FIN files with type ASM.
NEW.ZOT=B:OLD.ZAP	Move a copy of OLD.ZAP from drive B to the currently logged disk; name the file NEW.ZOT.



B:A.U = B:B.V,A:C.W,D.X

Concatenate file B.V from drive B with C.W from drive A and D.X from the logged disk; create the file A.U on drive B.

For convenience, PIP allows abbreviated commands for transferring files between disk drives. The abbreviated forms are

PIP d:=afn

PIP d<sub>1</sub>:=d<sub>2</sub>:afn

PIP ufn = d<sub>2</sub>:

PIP d<sub>1</sub>:ufn = d<sub>2</sub>:

The first form copies all files from the currently logged disk that satisfy the afn to the same files on drive d (d = A . . . P). The second form is equivalent to the first, where the source for the copy is drive d<sub>2</sub> (d<sub>2</sub> = A . . . P). The third form is equivalent to the command "PIP d<sub>1</sub>:ufn=d<sub>2</sub>:ufn" that copies the file given by ufn from drive d<sub>2</sub> to the file ufn on drive d<sub>1</sub>. The fourth form is equivalent to the third, where the source disk is explicitly given by d<sub>2</sub>.

The source and destination disks must be different in all of these cases. If an afn is specified, PIP lists each ufn that satisfies the afn as it is being copied. If a file exists by the same name as the destination file, it is removed on successful completion of the copy and replaced by the copied file.

The following PIP commands give examples of valid disk-to-disk copy operations:

B:=*.COM	Copy all files that have the secondary name "COM" to drive B from the current drive.
A:=B:ZAP.*	Copy all files that have the primary name "ZAP" to drive A from drive B.
ZAP.ASM=B:	Equivalent to ZAP.ASM=B:ZAP.ASM
B:ZOT.COM=A:	Equivalent to B:ZOT.COM=A:ZOT.COM
B:=GAMMA.BAS	Same as B:GAMMA.BAS=GAMMA.BAS
B:=A:GAMMA.BAS	Same as B:GAMMA.BAS=A:GAMMA.BAS

PIP allows reference to physical and logical devices that are attached to the CP/M system. The device names are the same as given under the STAT command, along with a number of specially named devices. The logical devices given in the STAT command are

CON: (console), RDR: (reader), PUN: (punch), and LST: (list)

while the physical devices are

TTY: (console, reader, punch, or list)

CRT: (console, or list), UC1: (console)

PTR: (reader), UR1: (reader), UR2: (reader)

PTP: (punch), UP1: (punch), UP2: (punch)

LPT: (list), UL1: (list)

(The "BAT:" physical device is not included, since this assignment is used only to indicate that the RDR: and LST: devices are used for console input/output.)

The RDR, LST, PUN, and CON devices are all defined within the BIOS portion of CP/M, and are easily altered for any particular I/O system. (The current physical device mapping is defined by IOBYTE; see Chapter 6 for a discussion of this function). The destination device must be capable of receiving data (i.e., data cannot be sent to the punch), and the source devices must be capable of generating data (i.e., the LST: device cannot be read).

The additional device names that can be used in PIP commands are

NUL:	Send 40 "nulls" (ASCII 0's) to the device (this can be issued at the end of punched output).
EOF:	Send a CP/M end-of-file (ASCII ctl-Z) to the destination device (sent automatically at the end of all ASCII data transfers through PIP).
INP:	Special PIP input source that can be patched into the PIP program: PIP gets the input data character-by-character by CALLing location 103H, with data returned in location 109H (parity bit must be zero).
OUT:	Special PIP output destination that can be patched into the PIP program: PIP CALLs location 106H with data in register C for each character to transmit. The user should note that locations 109H through 1FFH of the PIP memory image are not used and can be replaced by special purpose drivers using DDT (see Chapter 4).
PRN:	Same as LST: except that tabs are expanded at every eighth character position, lines are numbered, and page ejects are inserted every 60 lines with an initial eject (same as using PIP options [t8np]).

File and device names can be interspersed in the PIP commands. In each case, the specific device is read until end-of-file (ctl-Z for ASCII files, and end-of-data for non-ASCII disk files). Data from each device or file are concatenated from left to right until the last data source has been read. The destination device or file is written using the data from the source files, and an end-of-file character (ctl-Z) is appended to the result for ASCII files. If the destination is a disk file, a temporary file is created (\$\$\$ secondary name) that is changed to the actual file name only on successful completion of the copy. Files with the extension "COM" are always assumed to be non-ASCII.

The copy operation can be aborted at any time by depressing any key on the keyboard (a return suffices). PIP will respond with the message "ABORTED" to indicate that the operation has not been completed. If any operation is aborted, or if an error occurs during processing, PIP removes any pending commands that were set up while using the SUBMIT command.

PIP performs a special function if the destination is a disk file with type "HEX" (an Intel hex-formatted machine code file), and the source is an external peripheral device, such as a paper tape reader. In this case, the PIP program checks to ensure that the source file contains a properly formed hex file, with legal hexadecimal values and checksum records. When an invalid input record is found, PIP reports an error message at the console and waits for corrective action. It is usually sufficient to open the reader and rerun a section of the tape (pull the tape back about 20 inches). When the tape is ready for the reread, a single carriage return is typed at the console, and PIP will attempt another read. If the tape position cannot be properly read, the user continues the read (by typing a return following the error message), and enters the record manually with the ED program after the disk file is constructed. For convenience, PIP allows the end-of-file to be entered from the console if the source file is an RDR: device. In this case, the PIP program reads the device and monitors the keyboard. If ctl-Z is typed at the keyboard the read operation is terminated normally.

Valid PIP commands are

PIP LST; = X.PRN	Copy X.PRN to the LST device and terminate the PIP program.
PIP	Start PIP for a sequence of commands (PIP prompts with "***").
*CON:=X.ASM,Y.ASM,Z.ASM	Concatenate three ASM files and copy to the CON device.
*X.HEX=CON:;Y.HEX,PTR:	Create a HEX file by reading the CON (until a ctl-Z is typed), followed by data from Y.HEX and PTR until a ctl-Z is encountered.
(carriage return)	Single carriage return stops PIP.
PIP PUN:=NUL:;X.ASM,EOF:;NUL:	Send 40 nulls to the punch device; copy the X.ASM file to the punch, followed by an end-of-file (ctl-Z) and 40 more null characters.

The user can also specify one or more PIP parameters, enclosed in left and right square brackets, separated by zero or more blanks. Each parameter affects the copy operation, and the enclosed list of parameters must immediately follow the affected file or device. Generally, each parameter can be followed by an optional decimal integer value (the S and Q parameters are exceptions). Valid PIP parameters are

B	Block mode transfer: data are buffered by PIP until an ASCII x-off character (ctl-S) is received from the source device. This allows transfer of data to a disk file from a continuous reading device, such as a cassette reader. Upon receipt of the x-off, PIP clears the disk buffers and returns for more input data. The amount of data that can be buffered depends on the memory size of the host system (PIP will issue an error message if the buffers overflow).
Dn	Delete characters that extend past column n in the transfer of data to the destination from the character source. This parameter is generally used to truncate long lines that are sent to a (narrow) printer or console device.
E	Echo all transfer operations to the console as they are being performed.
F	Filter form feeds from the file. All imbedded form feeds are removed. The P parameter can be used simultaneously to insert new form feeds.
Gn	Get File from user number n (n in the range 0-15).
H	HEX data transfer: all data are checked for proper Intel hex file format. Nonessential characters between hex records are removed during the copy operation. The console will be prompted for corrective action in case errors occur.
I	Ignore ":00" records in the transfer of Intel hex format file (the I parameter automatically sets the H parameter).
L	Translate upper case alphabetic to lower case.

- N** Add line numbers to each line transferred to the destination, starting at one and incrementing by 1. Leading zeroes are suppressed, and the number is followed by a colon. If N2 is specified, leading zeroes are included and a tab is inserted following the number. The tab is expanded if T is set.
- O** Object file (non-ASCII) transfer: the normal CP/M end-of-file is ignored.
- Pn** Include page ejects at every n lines (with an initial page eject). If n = 1 or is excluded altogether, page ejects occur every 60 lines. If the F parameter is used, form feed suppression takes place before the new page ejects are inserted.
- Qstz** Quit copying from the source device or file when the string s (terminated by ctl-Z) is encountered.
- R** Read system files.
- Sstz** Start copying from the source device when the string s (terminated by ctl-Z) is encountered. The S and Q parameters can be used to "abstract" a particular section of a file (such as a subroutine). The start and quit strings are always included in the copy operation.
- If the user selects form (2) of the PIP command, the CCP translates strings following the S and Q parameters to upper case. Form (1) of the PIP invocation does not perform the automatic upper case translation.
- (1) PIP  
(2) PIP 'command line'
- Tn** Expand tabs (ctl-I characters) to every nth column during the transfer of characters to the destination from the source.
- U** Translate lower case alphabets to upper case during the copy operation.
- V** Verify that data have been copied correctly by rereading after the write operation (the destination must be a disk file).
- W** Write over R/O files without console interrogation.
- Z** Zero the parity bit on input for each ASCII character.

Valid PIP commands that specify parameters in the file transfer are

- |                            |   |
|----------------------------|---|
| PIP X.ASM=B:[v]            | Copy X.ASM from drive B to the current drive and verify that the data were properly copied.   |
| PIP LPT:=X.ASM[nt8u]       | Copy X.ASM to the LPT: device; number each line, expand tabs to every eighth column, and translate lower case alphabets to upper case.  |
| PIP PUN:=X.HEX[i],Y.ZOT[h] | First copy X.HEX to the PUN: device and ignore the trailing ":00" record in X.HEX; continue the transfer of data by reading Y.ZOT, which contains HEX records, including any ":00" records it contains. |

PIP X.LIB = Y.ASM [ sSUBRI:tz qJMP L3tz ]

Copy from the file Y.ASM into the file X.LIB. Start the copy when the string "SUBRI:" has been found, and quit copying after the string "JMP L3" is encountered.

PIP PRN:=X.ASM[p50]

Send X.ASM to the LST: device with line numbers, tabs expanded to every eighth column, and page ejects at every 50th line. The assumed parameter list for a PRN file is nt8p60; p50 overrides the default value.

Under normal operation, PIP will not overwrite a file that is set to a permanent R/O status. If an attempt is made to overwrite an R/O file, the prompt

DESTINATION FILE IS R/O, DELETE (Y/N)?

is issued. If the operator responds with the character "y" the file is overwritten. Otherwise, the response

\*\* NOT DELETED \*\*

is issued, the file transfer is skipped, and PIP continues with the next operation in sequence. To avoid the prompt and response in the case of R/O file overwrite, the command line can include the W parameter

PIP A:=B:\*.COM[W]

which copies all nonsystem files to the A drive from the B drive and overwrites any R/O files in the process. If the operation involves several concatenated files, the W parameter need only be included with the last file in the list, as in the example

PIP A.DAT = B.DAT,F:NEW.DAT,G:OLD.DAT[W]

Files with the system attribute can be included in PIP transfers if the R parameter is included; otherwise, system files are not recognized. The command line

PIP ED.COM = B:ED.COM[R]

for example, reads the ED.COM file from the B drive, even if it has been marked as an R/O and system file. The system file attributes are copied, if present.

Downward compatibility with previous versions of CP/M is only maintained if the file does not exceed one megabyte, no file attributes are set, and the file is created by user 0. If compatibility is required with nonstandard (e.g., "double density") versions of 1.4, it may be necessary to select 1.4 compatibility mode when constructing the internal disk parameter block. (See Chapter 6 and refer to Section 6.10, which describes BIOS differences.)

Note: To copy files into another user area, PIP.COM must be located in that user area. Follow the procedure shown below to make a copy of PIP.COM in another user area.

USER 0	Log-in user 0.
DDT PIP.COM (note PIP size s)	Load PIP to memory.
GO	Return to CCP.
USER 3	Log-in user 3.
SAVE s PIP.COM	

where *s* is the integral number of memory "pages" (256-byte segments) occupied by PIP. The number *s* can be determined when PIP.COM is loaded under DDT, by referring to the value under the NEXT display. If, for example, the next available address is 1D00, then PIP.COM requires 1C hexadecimal pages (or 1 times 16 + 12 = 28 pages), and the value of *s* is 28 in the subsequent save. Once PIP is copied in this manner, it can be copied to another disk belonging to the same user number through normal PIP transfers.

### 1.6.5 ED ufn

The ED program is the CP/M system context editor that allows creation and alteration of ASCII files in the CP/M environment. Complete details of operation are given in Chapter 2. ED allows the operator to create and operate upon source files that are organized as a sequence of ASCII characters, separated by end-of-line characters (a carriage-return line-feed sequence). There is no practical restriction on line length (no single line can exceed the size of the working memory) that is defined by the number of characters typed between carriage returns. The ED program has a number of commands for character string searching, replacement, and insertion that are useful in creation and correction of programs or text files under CP/M. Although the CP/M has a limited memory work space area (approximately 5000 characters in a 20K CP/M system), the file size that can be edited is not limited, since data are easily "paged" through this work area.

If it does not exist, ED creates the specified source file and opens the file for access. If the source file does exist (see the A command), the programmer "appends" data for editing. The appended data can then be displayed, altered, and written from the work area back to the disk (see the W command). Particular points in the program can be automatically paged and located by context (see the N command), allowing easy access to particular portions of a large file.

Given that the operator has typed

```
ED X.ASM
```

the ED program creates an intermediate work file with the name

```
X.$$$
```

to hold the edited data during the ED run. Upon completion of ED, the X.ASM file (original file) is renamed to X.BAK, and the edited work file is renamed to X.ASM. Thus, the X.BAK file contains the original (unedited) file, and the X.ASM file contains the newly edited file. The operator can always return to the previous version of a file by removing the most recent version and renaming the previous version. If the current X.ASM file has been improperly edited, the sequence of commands below will reclaim the backup file.

DIR X.*	Check to see that BAK file is available.
ERA X.ASM	Erase most recent version.
REN X.ASM=X.BAK	Rename the BAK file to ASM.

The operator can abort the edit at any point (reboot, power failure, `ctl-C`, or `Q` command) without destroying the original file. In this case, the BAK file is not created and the original file is always intact.

The ED program allows the user to edit the source on one disk and create the backup file on another disk. This form of the ED command is

```
ED ufn d:
```

where ufn is the name of the file to edit on the currently logged disk and d is the name of an alternate drive. The ED program reads and processes the source file and writes the new file to drive d using the name ufn. After processing, the original file becomes the backup file. If the operator is addressing disk A, the following command is valid:

**ED X.ASM B:**

This edits the file X.ASM on drive A, creating the new file X.\$\$\$ on drive B. After a successful edit, A:X.ASM is renamed to A:X.BAK, and B:X.\$\$\$ is renamed to B:X.ASM. For convenience the currently logged disk becomes drive B at the end of the edit. The user should note that if a file named B:X.ASM exists before the editing begins, the message

#### **FILE EXISTS**

is printed at the console as a precaution against accidentally destroying a source file. The operator first erases the existing file and then restarts the edit operation.

Similar to other transient commands, editing can take place on a drive different from the currently logged disk by preceding the source file name by a drive name. Examples of valid edit requests are

<b>ED A:X.ASM</b>	Edit the file X.ASM on drive A, with new file and backup on drive A.
<b>ED B:X.ASM A:</b>	Edit the file X.ASM on drive B to the temporary file X.\$\$\$ on drive A. After editing, change X.ASM on drive B to X.BAK and change X.\$\$\$ on drive A to X.ASM.

### **1.6.6 SYSGEN**

The SYSGEN transient command allows generation of an initialized diskette containing the CP/M operating system. The SYSGEN program prompts the console for commands by interacting as shown.

<b>SYSGEN cr</b>	Initiate the SYSGEN program.
<b>SYSGEN VERSION m.m</b>	SYSGEN sign-on message.
<b>SOURCE DRIVE NAME (OR RETURN TO SKIP)</b>	Respond with the drive name (one of the letters A, B, C, or D) of the disk containing a CP/M system, usually A. If a copy of CP/M already exists in memory due to a MOVCPM command, type a carriage return only. Typing a drive name d will cause the response:
<b>SOURCE ON d THEN TYPE RETURN</b>	Place a diskette containing the CP/M operating system on drive d (d is one of A, B, C, or D). Answer by typing a carriage return when ready.

FUNCTION COMPLETE	System is copied to memory. SYSGEN will then prompt with:
DESTINATION DRIVE NAME (OR RETURN TO REBOOT)	If a diskette is being initialized, place the new disk into a drive and answer with the drive name. Otherwise, type a cr and the system will reboot from drive A. Typing drive name d will cause SYSGEN to prompt with:
DESTINATION ON d THEN TYPE RETURN	Place new diskette into drive d; type return when ready.
FUNCTION COMPLETE	New diskette is initialized in drive d.

The "DESTINATION" prompt will be repeated until a single carriage return is typed at the console, so that more than one disk can be initialized.

Upon completion of a successful system generation, the new diskette contains the operating system and only the built-in commands are available. A factory-fresh, IBM-compatible diskette appears to CP/M as a diskette with an empty directory; therefore, the operator must copy the appropriate COM files from an existing CP/M diskette to the newly constructed diskette using the PIP transient.

The user can copy all files from an existing diskette by typing the PIP command

```
PIP B: = A: *.*[v]
```

which copies all files from disk drive A to disk drive B and verifies that each file has been copied correctly. The name of each file is displayed at the console as the copy operation proceeds.

The user should note that a SYSGEN does not destroy the files that already exist on a diskette; it only constructs a new operating system. If a diskette is being used only on drives B through P and will never be the source of a bootstrap operation on drive A, the SYSGEN need not take place.

### 1.6.7 SUBMIT ufn parm#1 ... parm#n

The SUBMIT command allows CP/M commands to be batched for automatic processing. The ufn given in the SUBMIT command must be the file name of a file that exists on the currently logged disk, with an assumed file type of "SUB." The SUB file contains CP/M prototype commands with possible parameter substitution. The actual parameters parm#1 ... parm#n are substituted into the prototype commands, and, if no errors occur, the file of substituted commands are processed sequentially by CP/M.

The prototype command file is created using the ED program, with interspersed "\$" parameters of the form

```
$1 $2 $3 ... $n
```

corresponding to the number of actual parameters that will be included when the file is submitted for execution. When the SUBMIT transient is executed, the actual parameters parm#1 ... parm#n are paired with the formal parameters \$1 ... \$n in the prototype commands. If the numbers of formal and actual parameters do not correspond, the



submit function is aborted with an error message at the console. The SUBMIT function creates a file of substituted commands with the name

\$\$\$SUB

on the logged disk. When the system reboots (at the termination of the SUBMIT), this command file is read by the CCP as a source of input rather than the console. If the SUBMIT function is performed on any disk other than drive A, the commands are not processed until the disk is inserted into drive A and the system reboots. The user can abort command processing at any time by typing a rubout when the command is read and echoed. In this case the \$\$\$SUB file is removed and the subsequent commands come from the console. Command processing is also aborted if the CCP detects an error in any of the commands. Programs that execute under CP/M can abort processing of command files when error conditions occur by erasing any existing \$\$\$SUB file.

To introduce dollar signs into a SUBMIT file, the user may type a "\$\$" which reduces to a single "\$" within the command file. An up-arrow symbol "^" may precede an alphabetic character x, which produces a single ctl-x character within the file.

The last command in a SUB file can initiate another SUB file, allowing chained batch commands.

Suppose the file ASMBL.SUB exists on disk and contains the prototype commands

```
ASM $1
DIR $1.*
ERA *.BAK
PIP $2:=$1.PRN
ERA $1.PRN
```

and the command

```
SUBMIT ASMBL X PRN
```

is issued by the operator. The SUBMIT program reads the ASMBL.SUB file, substituting "X" for all occurrences of \$1 and "PRN" for all occurrences of \$2. This results in a \$\$\$SUB file containing the commands

```
ASM X
DIR X.*
ERA *.BAK
PIP PRN:=X.PRN
ERA X.PRN
```

which are executed in sequence by the CCP.

The SUBMIT function can access a SUB file on an alternate drive by preceding the file name by a drive name. Submitted files are only acted upon when they appear on drive A. Thus it is possible to create a submitted file on drive B that is executed at a later time when inserted in drive A.

An additional utility program called XSUB extends the power of the SUBMIT facility to include line input to programs as well as the console command processor. The XSUB command is included as the first line of the submit file. When it is executed, XSUB self-relocates directly below the CCP. All subsequent submit command lines are processed by XSUB so that programs that read buffered console input (BDOS function 10)

receive their input directly from the submit file. For example, the file SAVER.SUB can contain the submit lines

```
XSUB
DDT
I$1.COM
R
G0
SAVE 1 $2.COM
```

with a subsequent SUBMIT command

```
A>SUBMIT SAVER PIP Y
```

that substitutes X for \$1 and Y for \$2 in the command stream. The XSUB program loads, followed by DDT, which is sent to the command lines PIP.COM, R, and G0, thus returning to the CCP. The final command SAVE 1 Y.COM is processed by the CCP.

The XSUB program remains in memory and prints the message

```
(xsub active)
```

on each warm start operation to indicate its presence. Subsequent submit command streams do not require the XSUB, unless an intervening cold start has occurred. The user should note that XSUB must be loaded after the optional CP/M DESPOOL utility, if both are to run simultaneously.

### 1.6.8 DUMP ufn

The DUMP program types the contents of the disk file (ufn) at the console in hexadecimal form. The file contents are listed sixteen bytes at a time, with the absolute byte address listed to the left of each line in hexadecimal. Long typeouts can be aborted by pushing the rubout key during printout. (The source listing of the DUMP program is given in Chapter 5 as an example of a program written for the CP/M environment.)

### 1.6.9 MOVCPM

The MOVCPM program allows the user to reconfigure the CP/M system for any particular memory size. Two optional parameters can be used to indicate the desired size of the new system and the disposition of the new system at program termination. If the first parameter is omitted or an "\*" is given, the MOVCPM program will reconfigure the system to its maximum size, based upon the kilobytes of contiguous RAM in the host system (starting at 0000H). If the second parameter is omitted, the system is executed, but not permanently recorded; if "\*" is given, the system is left in memory, ready for a SYSGEN operation. The MOVCPM program relocates a memory image of CP/M and places this image in memory in preparation for a system generation operation. The command forms are

MOVCPM	Relocate and execute CP/M for management of the current memory configuration (memory is examined for contiguous RAM, starting at 100H). On
--------	--

completion of the relocation, the new system is executed but not permanently recorded on the diskette. The system that is constructed contains a BIOS for the Intel MDS 800.

- |        |    |  |
|--------|----|--|
| MOVCPM | n  | Create a relocated CP/M system for management of an n kilobyte system (n must be in the range of 20 to 64), and execute the system as described.     |
| MOVCPM | ** | Construct a relocated memory image for the current memory configuration, but leave the memory image in memory in preparation for a SYSGEN operation. |
| MOVCPM | n* | Construct a relocated memory image for an n kilobyte memory system, and leave the memory image in preparation for a SYSGEN operation.                |

The command

MOVCPM \*\*

for example, constructs a new version of the CP/M system and leaves it in memory, ready for a SYSGEN operation. The message

READY FOR 'SYSGEN' OR  
'SAVE 34 CPMxx.COM'

is printed at the console upon completion, where xx is the current memory size in kilobytes. The operator can then type

- |   |  |
|---|--|
| SYSGEN  | Start the system generation.   |
| SOURCE DRIVE NAME<br>(OR RETURN TO SKIP)        | Respond with a carriage return to skip the CP/M read operation since the system is already in memory as a result of the previous MOVCPM operation. |
| DESTINATION DRIVE NAME<br>(OR RETURN TO REBOOT) | Respond with B to write new system to the diskette in drive B. SYSGEN will prompt with:  |
| DESTINATION ON B,<br>THEN TYPE RETURN           | Ready the fresh diskette on drive B and type a return when ready.  |

If the user responds with "A" rather than "B" above, the system will be written to drive A rather than B. SYSGEN will continue to type the prompt

DESTINATION DRIVE NAME (OR RETURN TO REBOOT)

until the operator responds with a single carriage return, which stops the SYSGEN program with a system reboot.

The user can then go through the reboot process with the old or new diskette. Instead of performing the SYSGEN operation, the user can type

SAVE 34 CPMxx.COM

at the completion of the MOVCPM function, where "xx" is the value indicated in the SYSGEN message. The CP/M memory image on the currently logged disk is in a form that can be "patched." This is necessary when operating in a nonstandard environment where the BIOS must be altered for a particular peripheral device configuration, as described in Chapter 6.

Valid MOVCPM commands are

MOVCPM	48	Construct a 48K version of CP/M and start execution.
MOVCPM	48 *	Construct a 48K version of CP/M in preparation for permanent recording; response is
		READY FOR 'SYSGEN' OR 'SAVE 34 CPM48.COM'
MOVCPM	* *	Construct a maximum memory version of CP/M and start execution.

The newly created system is serialized with the number attached to the original diskette and is subject to the conditions of the Digital Research Software Licensing Agreement.

## 1.7 BDOS Error Messages

There are three error situations that the Basic Disk Operating System intercepts during file processing. When one of these conditions is detected, the BDOS prints the message:

BDOS ERR ON d: error

where d is the drive name and "error" is one of the three error messages:

BAD SECTOR  
SELECT  
READ ONLY

The "BAD SECTOR" message indicates that the disk controller electronics has detected an error condition in reading or writing the diskette. This condition is generally caused by a malfunctioning disk controller or an extremely worn diskette. If the user finds that the CP/M reports this error more than once a month, the state of the controller electronics and the condition of the media should be checked. The user can also encounter this condition in reading files generated by a controller produced by a different manufacturer. Even though controllers are claimed to be IBM-compatible, one often finds small differences in recording formats. The MDS-800 controller, for example, requires two bytes of one's following the data CRC byte, which is not required in the IBM format. As a result, diskettes generated by the Intel MDS can be read by almost all other IBM-compatible systems, while disk files generated on other manufacturers' equipment will produce the "BAD SECTOR" message when read by the MDS. Recovery from this condition is accomplished by typing a ctl-C to reboot (the safest course), or a return,

which ignores the bad sector in the file operation. The user should, however, note that typing a return may destroy diskette integrity if the operation is a directory write. The user should be sure to have adequate backups in this case.

The "SELECT" error occurs when there is an attempt to address a drive beyond the range supported by the BIOS. In this case, the value of *d* in the error message gives the selected drive. The system reboots following any input from the console.

The "READ ONLY" message occurs when there is an attempt to write to a diskette or file that has been designated as read only in a STAT command or has been set to read only by the BDOS. The operator should reboot CP/M by using the warm start procedure (ctl-C) or by performing a cold start whenever the diskettes are changed. If a changed diskette is to be read but not written, BDOS allows the diskette to be changed without the warm or cold start, but internally marks the drive as read only. The status of the drive is subsequently changed to read/write if a warm or cold start occurs. On issuing this message, CP/M waits for input from the console. An automatic warm start takes place following any input.

## 1.8 Operation of CP/M on the MDS

This section gives operating procedures for using CP/M on the Intel MDS microcomputer development system. Basic knowledge of the MDS hardware and software systems is assumed.

CP/M is initiated in essentially the same manner as Intel's ISIS operating system. The disk drives are labeled 0 through 3 on the MDS, corresponding to CP/M drives A through D, respectively. The CP/M system diskette is inserted into drive 0, and the BOOT and RESET switches are depressed in sequence. The interrupt 2 light should go on at this point. The space bar is then depressed on the system console, and the light should go out (if it does not, the user should check connections and baud rates). The BOOT switch is turned off, and the CP/M sign-on message should appear at the selected console device, followed by the "A>" system prompt. The user can then issue the various resident and transient commands.

The CP/M system can be restarted (warm start) at any time by pushing the INT 0 switch on the front panel. The built-in Intel ROM monitor can be initiated by pushing the INT 7 switch (which generates an RST 7), except when operating under DDT, in which case the DDT program gets control instead.

Diskettes can be removed from the drives at any time, and the system can be shut down during operation without affecting data integrity. The user must not remove a diskette and replace it with another without rebooting the system (cold or warm start) unless the inserted diskette is "read only."

As a result of hardware hang-ups or malfunctions, CP/M may type the message

```
BDOS ERR ON d: BAD SECTOR
```

where *d* is the drive that has a permanent error. This error can occur when drive doors are opened and closed randomly, followed by disk operations, or can be caused by a diskette, drive, or controller failure. The user can optionally elect to ignore the error by typing a single return at the console. The error may produce a bad data record, requiring reinitialization of up to 128 bytes of data. The operator can reboot the CP/M system and try the operation again.

Termination of a CP/M session requires no special action, except that it is necessary to remove the diskettes before turning the power off to avoid random transients that often make their way to the drive electronics.

Factory-fresh, IBM-compatible diskettes should be used rather than diskettes that have previously been used with any ISIS version. In particular, the ISIS "FORMAT" operation produces nonstandard sector numbering throughout the diskette. This nonstandard numbering seriously degrades the performance of CP/M and will operate noticeably slower than the distribution version. If it becomes necessary to reformat a diskette (which should not be the case for standard diskettes), a program can be written under CP/M that causes the MDS 800 controller to reformat with sequential sector numbering (1-26) on each track.

IBM-compatible 8-inch diskettes in general do not need to be formatted. However, 5¼-inch diskettes will need to be formatted.



# 2 ED

## 2.1 Introduction to ED

ED is the context editor for CP/M, and is used to create and alter CP/M source files. ED is initiated in CP/M by typing

ED filename

or

ED filename. typ

In general, ED reads segments of the source file given by filename or filename.typ into the central memory, where the file is manipulated by the operator and subsequently written back to disk after alterations. If the source file does not exist before editing, it is created by ED and initialized to empty. The overall operation of ED is shown in Figure 2.1.

### 2.1.1 ED Operation

ED operates upon the source file, denoted in Figure 2.1 by x.y, and passes all text through a memory buffer where the text can be viewed or altered (the number of lines that can be maintained in the memory buffer varies with the line length, but has a total capacity of about 5000 characters in a 20K CP/M system). Text material that has been edited is written into a temporary work file under command of the operator. Upon termination of the edit, the memory buffer is written to the temporary file, followed by any remaining (unread) text in the source file. The name of the original file is changed from x.y to x.BAK so that the most recent previously edited source file can be reclaimed if necessary (see the CP/M commands ERASE and RENAME). The temporary file is then changed from x.\$\$\$ to x.y, which becomes the resulting edited file.

The memory buffer is logically between the source file and working file as shown in Figure 2.2.



Figure 2.1 Overall ED Operation

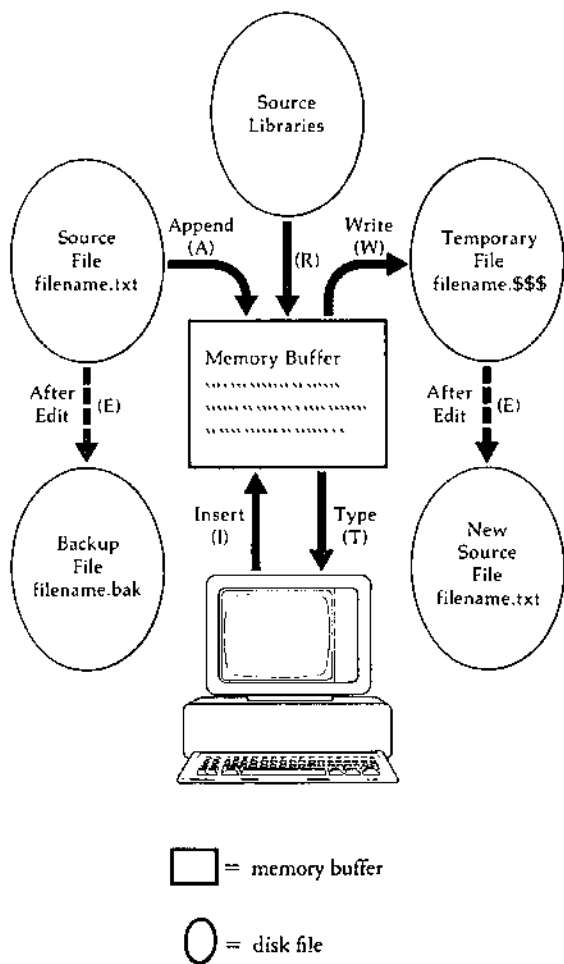
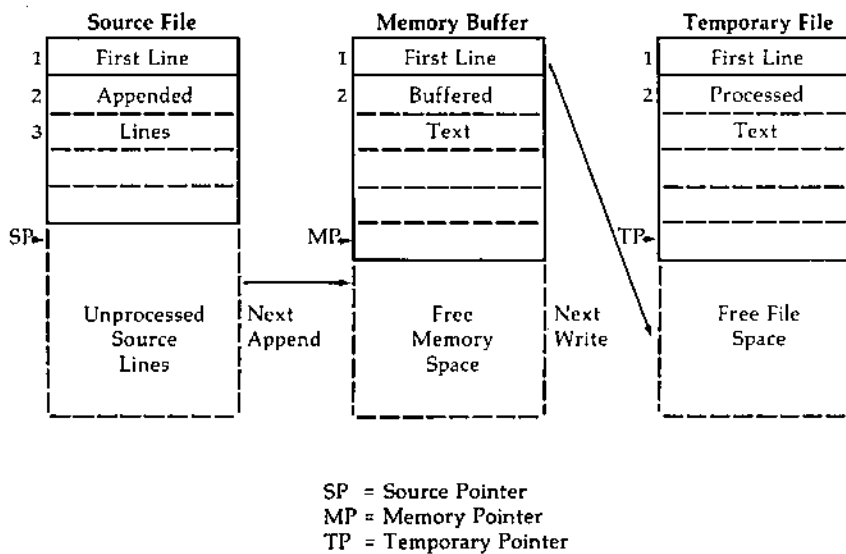

Figure 2.2 Memory Buffer Organization



## 2.1.2 Text Transfer Functions

Given that *n* is an integer value in the range 0 through 65535, several single letter ED commands transfer lines of text from the source file through the memory buffer to the temporary (and eventually final) file. Single letter commands are shown in upper case, but can be typed in either upper or lower case.

nA	Append the next <i>n</i> unprocessed source lines from the source file at SP to the end of the memory buffer at MP. Increment SP and MP by <i>n</i> . If upper case translation is set (see the U command) and the A command is typed in upper case, all input lines will automatically be translated to upper case.
nW	Write the first <i>n</i> lines of the memory buffer to the temporary file free space. Shift the remaining lines <i>n</i> +1 through MP to the top of the memory buffer. Increment TP by <i>n</i> .
E	End the edit. Copy all buffered text to temporary file and copy all unprocessed source lines to temporary file. Rename files as described previously.
H	Move to head of new file by performing automatic E command. Temporary file becomes the new source file, the memory buffer is emptied, and a new temporary file is created (equivalent to issuing an E command, followed by a reinvocation of ED using <i>x.y</i> as the file to edit).
O	Return to original file. The memory buffer is emptied, the temporary file is deleted, and the SP is returned to position 1 of the source file. The effects of the previous editing commands are thus nullified.
Q	Quit edit with no file alterations, return to CP/M.

There are a number of special cases to consider. If the integer *n* is omitted in any ED command where an integer is allowed, then 1 is assumed. Thus, the commands A and W append one line and write one line, respectively. In addition, if a pound sign (#) is given in the place of *n*, then the integer 65535 is assumed (the largest value for *n* that is allowed). Since most reasonably sized source files can be contained entirely in the memory buffer, the command #A is often issued at the beginning of the edit to read the entire source file to memory. Similarly, the command #W writes the entire buffer to the temporary file. Two special forms of the A and W commands are provided as a convenience. The command OA fills the current memory buffer at least half full, while OW writes lines until the buffer is at least half empty. An error is issued if the memory buffer size is exceeded. The operator can then enter any command (such as W) that does not increase memory requirements. The remainder of any partial line read during the overflow will be brought into memory on the next successful append.

## 2.1.3 Memory Buffer Organization

The memory buffer can be considered a sequence of source lines brought in with the A command from a source file. The memory buffer has an associated (imaginary) character pointer CP that moves throughout the memory buffer under command of the operator. The memory buffer appears logically as shown in Figure 2.3 where the dashes represent characters of the source line of indefinite length, terminated by carriage-return (<cr>) and line-feed (<lf>) characters, and CP represents the imaginary character pointer. The

user should note that the CP is always located ahead of the first character of the first line, behind the last character of the last line, or between two characters. The current line CL is the source line that contains the CP.

Figure 2.3 Logical Organization of Memory Buffer

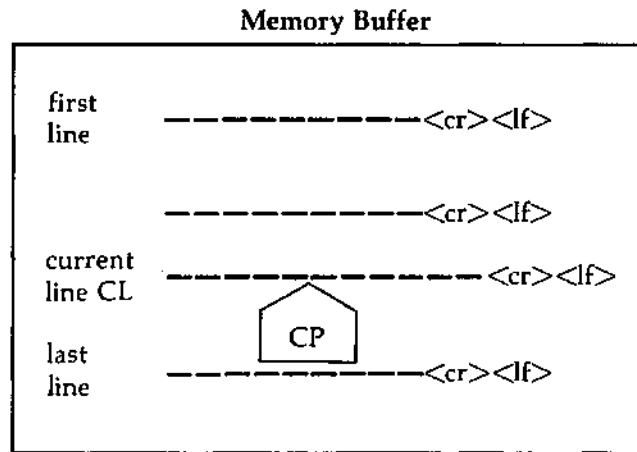

#### 2.1.4 Line Numbers and ED Start-up

ED produces absolute line number prefixes that can be used to reference a line, or range of lines. The absolute line number is displayed at the beginning of each line when ED is in "insert mode" (see the I command in Section 2.1.5), where each line number takes the form

nnnn:

where nnnnn is an absolute line number in the range of 1 to 65535. If the memory buffer is empty or if the current line is at the end of the memory buffer, nnnnn appears as 5 blanks.

The user may reference an absolute line number by preceding any command by a number followed by a colon, in the same format as the line number display. In this case, the ED program moves the current line reference to the absolute line number, if the line exists in the current memory buffer. The line denoted by the absolute line number must be in the memory buffer (see the A command). Thus, the command

345:T

is interpreted as "move to absolute 345, and type the line." Absolute line numbers are produced only during the editing process and are not recorded with the file. In particular, the line numbers will change following a deleted or expanded section of text.

The user may also reference an absolute line number as a backward or forward distance from the current line by preceding the absolute number by a colon. Thus, the command

:400T

is interpreted as "type from the current line number through the line whose absolute number is 400." Combining the two line reference forms, the command

```
345::400T
```

for example, is interpreted as "move to absolute line 345, then type through absolute line 400." Absolute line references of this sort can precede any of the standard ED commands.

Line numbering is controlled by the "V" (Verify line numbers) command. Line numbering can be disabled by typing the "-V" command.

If the file to edit does not exist, ED types the message

```
NEW FILE
```

The user must enter an "i" command so that text can be inserted into the memory buffer by typing input lines terminated by carriage-returns. A single ctl-Z character returns ED to command mode.

### 2.1.5 Memory Buffer Operation

When ED begins, the memory buffer is empty. The operator may either append lines (A command) from the source file or enter the lines directly from the console with the insert command

```
i
```

ED then accepts any number of input lines, where each line terminates with a <cr> (the <lf> is supplied automatically), until a control-z (denoted by tz) is typed by the operator. The CP is positioned after the last character entered. The sequence

```
<cr>  
NOW IS THE<cr>  
TIME FOR<cr>  
ALL GOOD MEN<cr>  
tz
```

leaves the memory buffer as

```
NOW IS THE<cr><lf>  
TIME FOR<cr><lf>  
ALL GOOD MEN<cr><lf>
```

Generally, ED accepts command letters in upper or lower case. If the command is upper case, all input values associated with the command are translated to upper case. In particular, if the "I" command is typed, all input lines are automatically translated internally to upper case. The lower case form of the "i" command is most often used to allow both upper and lower case letters to be entered.

Various commands can be issued that manipulate the CP or display source text in the vicinity of the CP. The commands shown below with a preceding n indicate that an

optional unsigned value can be specified. When preceded by  $\pm$ , the command can be unsigned, or have an optional preceding plus or minus sign. As before, the pound sign (#) is replaced by 65535. If an integer  $n$  is optional, but not supplied, then  $n = 1$  is assumed. Finally, if a plus sign is optional, but none is specified, then  $+$  is assumed.

$\pm B$	Move CP to beginning of memory buffer if $+$ and to bottom if $-$ .
$\pm nC$	Move CP by $\pm n$ characters (moving ahead if $+$ ), counting the $\langle cr \rangle \langle lf \rangle$ as two distinct characters.
$\pm nD$	Delete $n$ characters ahead of CP if plus and behind CP if minus.
$\pm nK$	Kill (i.e., remove) $\pm n$ lines of source text using CP as the current reference. If CP is not at the beginning of the current line when K is issued, the characters before CP remain if $+$ is specified, while the characters after CP remain if $-$ is given in the command.
$\pm nL$	If $n = 0$ , move CP to the beginning of the current line (if it is not already there). If $n \neq 0$ , first move the CP to the beginning of the current line and then move it to the beginning of the line that is $n$ lines down (if $+$ ) or up (if $-$ ). The CP will stop at the top or bottom of the memory buffer if too large a value of $n$ is specified.
$\pm nT$	If $n = 0$ , type the contents of the current line up to CP. If $n = 1$ , type the contents of the current line from CP to the end of the line. If $n > 1$ , type the current line along with $n - 1$ lines that follow, if $+$ is specified. Similarly, if $n > 1$ and $-$ is given, type the previous $n$ lines up to the CP. Any key can be depressed to abort long type-outs.
$\pm n$	Equivalent to $\pm nLT$ , which moves up or down and types a single line.

## 2.1.6 Command Strings

Any number of commands can be typed contiguously (up to the capacity of the console buffer) and are executed only after the  $\langle cr \rangle$  is typed. Thus, the operator may use the CP/M console line editing operation to manipulate the input command line:

ctl-C	CP/M system reboot when typed at start of line.
ctl-E	Physical end of line: carriage is returned, but line is not sent until the carriage return key is depressed.
ctl-H	Backspace one character position.
ctl-J	Terminate current input (line feed).
ctl-M	Terminate current input (carriage return).
ctl-R	Retype current command line: types a "clean line" following character deletion with rubouts.
ctl-U	Delete the entire line typed at the console.
ctl-X	Same as ctl-U.
ctl-Z	End input from the console (used in PIP and ED).
rub/del	Delete and echo the last character typed at the console.

Suppose the memory buffer contains the characters shown in the previous section, with the CP following the last character of the buffer. The command strings shown below produce the results shown to the right. Use lower case command letters to avoid automatic translation of strings to upper case.

Command String	Effect	Resulting Memory Buffer
1. B2T<cr>	Move to beginning of buffer and type 2 lines: 'NOW IS THE TIME FOR'	NOW IS THE<cr><lf> TIME FOR<cr><lf> ALL GOOD MEN<cr><lf>
2. 5C0T<cr>	Move CP 5 characters and type the beginning of the line 'NOW I'	NOW I S THE <cr><lf>
3. 2L-T<cr>	Move two lines down and type previous line 'TIME FOR'	NOW IS THE<cr><lf> TIME FOR<cr><lf> ALL GOOD MEN<cr><lf>
4. -L#K<cr>	Move up one line, delete 65535 lines that follow	NOW IS THE<cr><lf>
5. I<cr> TIME TO<cr> INSERT<cr> tz	Insert two lines of text with automatic translation to upper case	NOW IS THE<cr><lf> TIME TO<cr><lf> INSERT<cr><lf>
6. -2L#T<cr>	Move up two lines and type 65535 lines ahead of CP 'NOW IS THE'	NOW IS THE<cr><lf> TIME TO<cr><lf> INSERT<cr><lf>
7. <cr>	Move down one line and type one line 'INSERT'	NOW IS THE<cr><lf> TIME TO<cr><lf> INSERT<cr><lf>



### 2.1.7 Text Search and Alteration

ED also has a command that locates strings within the memory buffer. The command takes the form

```
nF s <cr>
or
nF s tz
```

where *s* represents the string to match, followed by either a <cr> or ctl-Z, denoted by tz. ED starts at the current position of CP and attempts to match the string. The match is attempted *n* times, and, if successful, the CP is moved directly after the string. If the *n* matches are not successful, the CP is not moved from its initial position. Search strings can include ctl-L, which is replaced by the pair of symbols <cr><lf>.

The following commands illustrate the use of the F command:

Command String	Effect	Resulting Memory Buffer
1. B#T<cr>	Move to beginning and type entire buffer	 NOW IS THE<cr><lf> TIME FOR<cr><lf> ALL GOOD MEN<cr><lf>
2. FS T<cr>	Find the end of the string 'S T'	NOW IS T  HE<cr><lf>
3. FIz0TT	Find the next 'I' and type to the CP; then type the remainder of the current line: 'ME FOR'	NOW IS THE<cr><lf> TI  ME FOR<cr><lf> ALL GOOD MEN<cr><lf>





An abbreviated form of the insert command is also allowed, which is often used in conjunction with the F command to make simple textual changes. The form is

I s lz

or

I s<cr>

where s is the string to insert. If the insertion string is terminated by a lz, the string is inserted directly following the CP, and the CP positioned directly after the string. The action is the same if the command is followed by a <cr> except that a <cr><lf> is automatically inserted into the text following the string. Consider the following command sequences as examples of the F and I commands:

Command String	Effect	Resulting Memory Buffer
1. BITHIS IS lz<cr>	Insert 'THIS IS' at the beginning of the text	THIS IS  NOW THE<cr><lf> TIME FOR<cr><lf> ALL GOOD MEN<cr><lf>
2. FTIMElz-4DIPLACElz<cr>	Find 'TIME' and delete it; then insert 'PLACE'	THIS IS NOW THE<cr><lf> PLACE  FOR<cr><lf> ALL GOOD MEN<cr><lf>
3. 3FOlz-3D5D1 CHANGESlz<cr>	Find third occurrence of 'O' (i.e., the second 'O' in GOOD), delete previous 3 characters and the subsequent 5 characters; then insert 'CHANGES'	THIS IS NOW THE<cr><lf> PLACE FOR<cr><lf> ALL CHANGES  <cr><lf>
4. -8CISOURCE<cr>	Move back 8 characters and insert the line 'SOURCE<cr><lf>'	THIS IS NOW THE<cr><lf> PLACE FOR<cr><lf> ALL SOURCE<cr><lf>  CHANGES<cr><lf>

ED also provides a single command that combines the F and I commands to perform simple string substitutions. The command takes the form

n S s<sub>1</sub>lz s<sub>2</sub> <cr>

or

n S s<sub>1</sub>lz s<sub>2</sub> lz

and has exactly the same effect as applying the following command string a total of *n* times:

```
F s1 |z-kD|s2 <cr>
or
F s1 |z-kD|s2 |z
```

where *k* is the length of the string. That is, ED searches the memory buffer starting at the current position of CP and successively substitutes the second string for the first string until the end of buffer or until the substitution has been performed *n* times.

As a convenience, a command similar to F is provided by ED, which automatically appends and writes lines as the search proceeds. The form is

```
n N s <cr>
or
n N s |z ,
```

which searches the entire source file for the *n*th occurrence of the strings (the user should recall that F fails if the string cannot be found in the current buffer). The operation of the N command is precisely the same as F except in the case that the string cannot be found within the current memory buffer. In this case, the entire memory content is written (i.e., an automatic #W is issued). Input lines are then read until the buffer is at least half full or the entire source file is exhausted. The search continues in this manner until the string has been found *n* times or until the source file has been completely transferred to the temporary file.

A final line editing function, called the juxtaposition command, takes the form

```
n J s1|z s2|z s3 <cr>
or
n J s1|z s2|z s3 |z
```

with the following action applied *n* times to the memory buffer: search from the current CP for the next occurrence of the string *s*<sub>1</sub>. If found, insert the string *s*<sub>2</sub>, and move CP to follow *s*<sub>2</sub>. Then delete all characters following CP up to (but not including) the string *s*<sub>3</sub>, leaving CP directly after *s*<sub>2</sub>. If *s*<sub>3</sub> cannot be found, then no deletion is made. If the current line is

```
NOW IS THE TIME<cr><lf>
```

the command

```
JW |zWHAT|z|l<cr>
```

results in

```
NOW WHAT <cr |f>
```

(The user should recall that |l (ctl-L) represents the pair <cr><lf> in search and substitute strings.)

The number of characters allowed by ED in the F, S, N, and J commands is limited to 100 symbols.



## 2.1.8 Source Libraries

ED also allows the inclusion of source libraries during the editing process with the R command. The form of this command is

```
R filename lz  
or  
R filename <cr>
```

where filename is the primary filename of a source file on the disk with an assumed filetype of 'LIB'. ED reads the specified file, and places the characters into the memory buffer after CP, in a manner similar to the I command. Thus, if the command

```
RMACRO<cr>
```

is issued by the operator, ED reads from the file MACRO.LIB until the end-of-file and automatically inserts the characters into the memory buffer.

ED also includes a "block move" facility implemented through the X (Xfer) command. The form

```
nX
```

transfers the next n lines from the current line to a temporary file called

```
X$$$$$.LIB
```

which is active only during the editing process. In general, the user can reposition the current line reference to any portion of the source file and transfer lines to the temporary file. The transferred lines accumulate one after another in this file and can be retrieved by simply typing

```
R
```

which is the trivial case of the library read command. In this case, the entire transferred set of lines is read into the memory buffer. The user should note that the X command does not remove the transferred lines from the memory buffer, although a K command can be used directly after the X, and the R command does not empty the transferred LIB file. That is, given that a set of lines has been transferred with the X command, they can be reread any number of times back into the source file. The command

```
OX
```

is provided, however, to empty the transferred line file.

The user should note that upon normal completion of the ED program through Q or E, the temporary LIB file is removed. If ED is aborted through ctl-C, the LIB file will exist if lines have been transferred, but will generally be empty (a subsequent ED invocation will erase the temporary file).

## 2.1.9 Repetitive Command Execution

The macro command M allows the ED user to group ED commands together for repeated evaluation. The M command takes the form

```
n M CS <cr>  
or  
n M CS lz
```

where CS represents a string of ED commands, not including another M command. ED executes the command string n times if n>1. If n=0 or 1, the command string is executed repetitively until an error condition is encountered (e.g., the end of the memory buffer is reached with an F command).

As an example, the following macro changes all occurrences of GAMMA to DELTA within the current buffer, and types each line that is changed

```
MFGAMMA1z-5DIDELTA1z0TT<cr>
```

or equivalently

```
MSGAMMA1zDELTA1z0TT<cr>
```

## 2.2 ED Error Conditions

On error conditions, ED prints the message "BREAK X AT C" where X is one of the error indicators shown below:

- ? Unrecognized command.
- > Memory buffer full (use one of the commands D, K, N, S, or W to remove characters); F, N, or S strings too long.
- # Cannot apply command the number of times specified (e.g., in F command).
- O Cannot open LIB file in R command.

If there is a disk error, CP/M displays the following message:

```
BDOS ERR on d: BAD SECTOR
```

The operator can choose to ignore the error by pressing the return key at the console (in this case, the memory buffer data should be examined to see if they were incorrectly read), or the user can reset the system by ctl-C and reclaim the backup file if it exists. The file can be reclaimed by first typing the contents of the BAK file to ensure that it contains the proper information

```
TYPE x.BAK
```

where x is the file being edited. Then remove the primary file

```
ERA x.y
```

and rename the BAK file

```
REN x.y=x.BAK
```

The file can then be reedited, starting with the previous version.

ED also takes file attributes into account. If the operator attempts to edit a read/only file, the message

```
** FILE IS READ/ONLY **
```

appears at the console. The file can be loaded and examined, but cannot be altered. Normally the operator simply ends the edit session and uses STAT to change the file attribute to R/W. If the edited file has the "system" attribute set, the message

'SYSTEM' FILE NOT ACCESSIBLE

is displayed and the edit session is aborted. Again, the STAT program can be used to change the system attribute, if desired.

## 2.3 Control Characters and Commands

The following tabulation summarizes the control characters and commands available in ED:

Control Character	Function
ctl-C	System reboot
ctl-E	Physical <cr><lf> (not actually entered in command)
ctl-H	Backspace
ctl-J	Logical tab (cols 1, 9, 16,...)
ctl-L	Logical <cr><lf> in search and substitute strings
ctl-R	Repeat line
ctl-U	Line delete
ctl-X	Line delete
ctl-Z	String terminator
rub/del	Character delete

Command	Function
nA	Append lines
±B	Begin or bottom of buffer
±nC	Move character positions
±nD	Delete characters
E	End edit and close files (normal end)
nF	Find string
H	End edit, close and reopen files
I	Insert characters, use i if both upper and lower case characters are to be entered
nJ	Place strings in juxtaposition
±nK	Kill lines
±nL	Move down/up lines
nM	Macro definition
nN	Find next occurrence with autoscan

O	Return to original file
$\pm nP$	Move and print pages
Q	Quit with no file changes
R	Read library file
nS	Substitute strings
$\pm nT$	Type lines
$\pm U$	Translate lower to upper case if U, no translation if -U
$\pm V$	Verify line numbers, or show remaining free character space
0V	A special case of the V command, 0V, prints the memory buffer statistics in the form <div style="text-align: center;">free/total</div> where free is the number of free bytes in the memory buffer (in decimal) and total is the size of the memory buffer
nW	Write lines
nZ	Wait (sleep) for approximately n seconds
$\pm n$	Move and type ( $\pm nLT$ ).

Because of common typographical errors, ED requires several potentially disastrous commands to be typed as single letters, rather than in composite commands. The commands

E(end), H(head), O(original), Q(quit)

must be typed as single letter commands.

The commands I, J, M, N, R, and S should be typed as i, j, m, n, r, and s if both upper and lower case characters are used in the operation, otherwise all characters are converted to upper case. When a command is entered in upper case, ED automatically converts the associated string to upper case, and vice-versa.



# 3

## CP/M Assembler

### 3.1 Introduction

The CP/M assembler reads assembly language source files from the diskette and produces 8080 machine language in Intel hex format. The CP/M assembler is initiated by typing

ASM filename

or

ASM filename.parms

In both cases, the assembler assumes there is a file on the diskette with the name

filename.ASM

which contains an 8080 assembly language source file. The first and second forms shown above differ only in that the second form allows parameters to be passed to the assembler to control source file access and hex and print file destinations.

In either case, the CP/M assembler loads and prints the message

CP/M ASSEMBLER VER n.n

where n.n is the current version number. In the case of the first command, the assembler reads the source file with assumed file type ASM and creates two output files

filename.HEX

and

filename.PRN

The HEX file contains the machine code corresponding to the original program in Intel hex format, and the PRN file contains an annotated listing showing generated machine

code, error flags, and source lines. If errors occur during translation, they will be listed in the PRN file as well as at the console.

The form ASM filename parms can be used to redirect input and output files from their defaults. In this case, the parms portion of the command is a three-letter group that specifies the origin of the source file, the destination of the hex file, and the destination of the print file. The form is

filename.p1p2p3

where p1, p2, and p3 are single letters

P1: A,B, ..., P designates the disk name that contains the source file

p2: A,B, ..., P designates the disk name that will receive the hex file

Z skips the generation of the hex file

p3: A,B, ..., P designates the disk name that will receive the print file

X places the listing at the console

Z skips generation of the print file

Thus, the command

ASM X.AAA

indicates that the source file (X.ASM) is to be taken from disk A and that the hex (X.HEX) and print (X.PRN) files are also to be created on disk A. This form of the command is implied if the assembler is run from disk A. That is, given that the operator is currently addressing disk A, the above command is equivalent to

ASM X

The command

ASM X.ABX

indicates that the source file is to be taken from disk A, the hex file is to be placed on disk B, and the listing file is to be sent to the console. The command

ASM X.BZZ

takes the source file from disk B and skips the generation of the hex and print files (this command is useful for fast execution of the assembler to check program syntax).

The source program format is compatible with the Intel 8080 assembler (macros are not implemented in ASM; see the optional MAC macro assembler). There are certain extensions in the CP/M assembler that make it somewhat easier to use. These extensions are described below.

## 3.2 Program Format

An assembly language program acceptable as input to the assembler consists of a sequence of statements of the form

line# label operation operand ;comment

where any or all of the fields may be present in a particular instance. Each assembly language statement is terminated with a carriage return and line feed (the line feed is inserted automatically by the ED program), or with the character !, which is treated as an end-of-line by the assembler (thus, multiple assembly language statements can be written on the same physical line if separated by exclamation mark symbols).

The line# is an optional decimal integer value representing the source program line number, and ASM ignores this field if present.

The label field takes the form

identifier

or

identifier:

and is optional, except where noted in particular statement types. The identifier is a sequence of alphanumeric characters where the first character is alphabetic. Identifiers can be freely used by the programmer to label elements such as program steps and assembler directives, but cannot exceed 16 characters in length. All characters are significant in an identifier, except for the embedded dollar symbol (\$), which can be used to improve readability of the name. Further, all lower case alphabets are treated as if they were upper case. The following are all valid instances of labels

x	xy	long\$name
x:	ysl:	longer\$name\$data:
X1Y2	X1x2	x234\$5678\$9012\$3456:

The operation field contains either an assembler directive or pseudo-operation, or an 8080 machine operation code. The pseudo-operations and machine operation codes are described below.

The operand field of the statement, in general, contains an expression formed out of constants and labels, along with arithmetic and logical operations on these elements. Again, the complete details of properly formed expressions are given below.

The comment field contains arbitrary characters following the ; symbol until the next real or logical end-of-line. These characters are read, listed, and otherwise ignored by the assembler. The CP/M assembler also treats statements that begin with an \* in column one as comment statements, which are listed and ignored in the assembly process.

The assembly language program is formulated as a sequence of statements of the above form, terminated by an optional END statement. All statements following the END are ignored by the assembler.

### 3.3 Forming the Operand

To describe the operation codes and pseudo-operations completely, it is necessary first to present the form of the operand field, since it is used in nearly all statements. Expressions in the operand field consist of simple operands (labels, constants, and reserved words), combined in properly formed subexpressions by arithmetic and logical operators. The expression computation is carried out by the assembler as the assembly proceeds. Each expression must produce a 16-bit value during the assembly. Further, the number of significant digits in the result must not exceed the intended use. That is, if an expression is to be used in a byte move immediate instruction, the most significant 8 bits of the expression must be zero. The restriction on the expression significance is given with the individual instructions.



### 3.3.1 Labels

As discussed above, a label is an identifier that occurs on a particular statement. In general, the label is given a value determined by the type of statement that it precedes. If the label occurs on a statement that generates machine code or reserves memory space (e.g., a MOV instruction or a DS pseudo-operation), the label is given the value of the program address that it labels. If the label precedes an EQU or SET, the label is given the value that results from evaluating the operand field. Except for the SET statement, an identifier can label only one statement.

When a label appears in the operand field, its value is substituted by the assembler. This value can then be combined with other operands and operators to form the operand field for a particular instruction.

### 3.3.2 Numeric Constants

A numeric constant is a 16-bit value in one of several bases. The base, called the radix of the constant, is denoted by a trailing radix indicator. The radix indicators are

B	binary constant (base 2)
O	octal constant (base 8)
Q	octal constant (base 8)
D	decimal constant (base 10)
H	hexadecimal constant (base 16)

Q is an alternate radix indicator for octal numbers since the letter O is easily confused with the digit 0. Any numeric constant that does not terminate with a radix indicator is assumed to be a decimal constant.

A constant is thus composed as a sequence of digits, followed by an optional radix indicator, where the digits are in the appropriate range for the radix. That is, binary constants must be composed of 0 and 1 digits, octal constants can contain digits in the range 0-7, while decimal constants contain decimal digits. Hexadecimal constants contain decimal digits as well as hexadecimal digits A (10D), B (11D), C (12D), D (13D), E (14D), and F (15D). The user should note that the leading digit of a hexadecimal constant must be a decimal digit to avoid confusing a hexadecimal constant with an identifier (a leading 0 will always suffice). A constant composed in this manner must evaluate to a binary number that can be contained within a 16-bit counter, otherwise it is truncated on the right by the assembler. Similar to identifiers, imbedded \$ signs are allowed within constants to improve their readability. Finally, the radix indicator is translated to upper case if a lower case letter is encountered. The following are all valid instances of numeric constants

1234	1234D	1100B	1111\$0000\$1111\$0000B
1234H	0FFEH	3377O	33\$77\$22Q
3377o	0fe3h	1234d	0ffffh

### 3.3.3 Reserved Words

There are several reserved character sequences that have predefined meanings in the

operand field of a statement. The names of 8080 registers are given below. When they are encountered, they produce the values shown to the right.

A	7
B	0
C	1
D	2
E	3
H	4
L	5
M	6
SP	6
PSW	6

(Again, lower case names have the same values as their upper case equivalents.) Machine instructions can also be used in the operand field and evaluate to their internal codes. In the case of instructions that require operands, where the specific operand becomes a part of the binary bit pattern of the instruction (e.g., MOV A,B), the value of the instruction (in this case MOV) is the bit pattern of the instruction with zeroes in the optional fields (e.g., MOV produces 40H)

When the symbol \$ occurs in the operand field (not imbedded within identifiers and numeric constants), its value becomes the address of the next instruction to generate, not including the instruction contained within the current logical line.

### 3.3.4 String Constants

String constants represent sequences of ASCII characters and are represented by enclosing the characters within apostrophe symbols ('). All strings must be fully contained within the current physical line (thus allowing ! symbols within strings) and must not exceed 64 characters in length. The apostrophe character itself can be included within a string by representing it as a double apostrophe (the two keystrokes "), which becomes a single apostrophe when read by the assembler. In most cases, the string length is restricted to either one or two characters (the DB pseudo-operation is an exception), in which case the string becomes an 8- or 16-bit value, respectively. Two character strings become a 16-bit constant, with the second character as the low order byte, and the first character as the high order byte.

The value of a character is its corresponding ASCII code. There is no case translation within strings, and thus both upper and lower case characters can be represented. The user should note, however, that only graphic (printing) ASCII characters are allowed within strings.

Valid strings are	which represent
'A' 'AB' 'ab' 'c'	A AB ab c
''a'' '''' ''''	a' ' ' '
'Walla Walla Wash.'	Walla Walla Wash.
'She said "Hello" to me.'	She said "Hello" to me
'I said "Hello" to her.'	I said "Hello" to her

### 3.3.5 Arithmetic and Logical Operators

The operands described above can be combined in normal algebraic notation using any combination of properly formed operands, operators, and parenthesized expressions. The operators recognized in the operand field are

$a + b$	unsigned arithmetic sum of a and b
$a - b$	unsigned arithmetic difference between a and b
$+ b$	unary plus (produces b)
$- b$	unary minus (identical to $0 - b$ )
$a * b$	unsigned magnitude multiplication of a and b
$a / b$	unsigned magnitude division of a by b
$a \text{ MOD } b$	remainder after $a / b$
NOT b	logical inverse of b (all 0s become 1s, 1s become 0s), where b is considered a 16-bit value
a AND b	bit-by-bit logical and of a and b
a OR b	bit-by-bit logical or of a and b
a XOR b	bit-by-bit logical exclusive or of a and b
a SHL b	the value that results from shifting a to the left by an amount b, with zero fill
a SHR b	the value that results from shifting a to the right by an amount b, with zero fill.

In each case, a and b represent simple operands (labels, numeric constants, reserved words, and one or two character strings) or fully enclosed parenthesized subexpressions such as

```
10+20 10h+37Q LI /3 (L2+4) SHR 3
('a' and 5fh) + '0' ('B'+B) OR (PSW+M)
(1+(2+c)) shr (A-(B+1))
```

Note that all computations are performed at assembly time as 16-bit unsigned operations. Thus, -1 is computed as 0-1, which results in the value 0ffffh (i.e., all 1s). The resulting expression must fit the operation code in which it is used. For example, if the expression is used in an ADI (add immediate) instruction, the high order 8 bits of the expression must be zero. As a result, the operation ADI -1 produces an error message (-1 becomes 0ffffh, which cannot be represented as an 8-bit value), while ADI (-1) AND 0FFH is accepted by the assembler since the AND operation zeroes the high order bits of the expression.

### 3.3.6 Precedence of Operators

As a convenience to the programmer, ASM assumes that operators have a relative precedence of application that allows the programmer to write expressions without nested levels of parentheses. The resulting expression has assumed parentheses that are defined by the relative precedence. The order of application of operators in unparenthesized expressions is listed below. Operators listed first have highest precedence (they are applied first in an unparenthesized expression), while operators listed last have lowest

precedence. Operators listed on the same line have equal precedence, and are applied from left to right as they are encountered in an expression

\* / MOD SHL SHR  
- +  
NOT  
AND  
OR XOR

Thus, the expressions shown to the left below are interpreted by the assembler as the fully parenthesized expressions shown to the right

a * b + c	(a * b) + c
a + b * c	a + (b * c)
a MOD b * c SHL d	((a MOD b) * c) SHL d
a OR b AND NOT c + d SHL e	a OR (b AND (NOT (c + (d SHL e))))

Balanced parenthesized subexpressions can always be used to override the assumed parentheses; thus, the last expression above could be rewritten to force application of operators in a different order as

(a OR b) AND (NOT c) + d SHL e

resulting in the assumed parentheses

(a OR b) AND ((NOT c) + (d SHL e))

An unparenthesized expression is well-formed only if the expression that results from inserting the assumed parentheses is well-formed.

## 3.4 Assembler Directives

Assembler directives are used to set labels to specific values during the assembly, perform conditional assembly, define storage areas, and specify starting addresses in the program. Each assembler directive is denoted by a pseudo-operation that appears in the operation field of the line. The acceptable pseudo-operations are

ORG	set the program or data origin
END	end program, optional start address
EQU	numeric "equate"
SET	numeric "set"
IF	begin conditional assembly
ENDIF	end of conditional assembly
DB	define data bytes

DW	define data words
DS	define data storage area

The individual directives are detailed below.

### 3.4.1 The ORG Directive

The ORG statement takes the form

```
label ORG expression
```

where "label" is an optional program identifier and expression is a 16-bit expression, consisting of operands that are defined before the ORG statement. The assembler begins machine code generation at the location specified in the expression. There can be any number of ORG statements within a particular program, and there are no checks to ensure that the programmer is not defining overlapping memory areas. The user should note that most programs written for the CP/M system begin with an ORG statement of the form

```
ORG 100H
```

which causes machine code generation to begin at the base of the CP/M transient program area. If a label is specified in the ORG statement, the label is given the value of the expression (this label can then be used in the operand field of other statements to represent this expression).

### 3.4.2 The END Directive

The END statement is optional in an assembly language program, but if it is present it must be the last statement (all subsequent statements are ignored in the assembly). The two forms of the END directive are

```
label END
```

```
label END expression
```

where the label is again optional. If the first form is used, the assembly process stops, and the default starting address of the program is taken as 0000. Otherwise, the expression is evaluated, and becomes the program starting address (this starting address is included in the last record of the Intel formatted machine code hex file, which results from the assembly). Thus, most CP/M assembly language programs end with the statement

```
END 100H
```

resulting in the default starting address of 100H (beginning of the transient program area).

### 3.4.3 The EQU Directive

The EQU (equate) statement is used to set up synonyms for particular numeric values. The form is

```
label EQU expression
```

where the label must be present and must not label any other statement. The assembler evaluates the expression, and assigns this value to the identifier given in the label field. The identifier is usually a name that describes the value in a more human-oriented manner. Further, this name is used throughout the program to "parameterize" certain functions. Suppose data received from a teletype appear on a particular input port and data are sent to the teletype through the next output port in sequence. The series of equate statements could be used to define these ports for a particular hardware environment

```
TTYBASE EQU 10H ;BASE PORT NUMBER FOR TTY
TTYIN EQU TTYBASE ;TTY DATA IN
TTYOUT EQU TTYBASE+1 ;TTY DATA OUT
```

At a later point in the program, the statements that access the teletype could appear as

```
IN TTYIN ;READ TTY DATA TO REG-A
...
OUT TTYOUT ;WRITE DATA TO TTY FROM REG-A
```

making the program more readable than if the absolute I/O ports had been used. Further, if the hardware environment is redefined to start the teletype communications ports at 7FH instead of 10H, the first statement need only be changed to

```
TTYBASE EQU 7FH ;BASE PORT NUMBER FOR TTY
```

and the program can be reassembled without changing any other statements.

### 3.4.4 The SET Directive

The SET statement is similar to the EQU, taking the form

```
label SET expression
```

except that the label can occur on other SET statements within the program. The expression is evaluated and becomes the current value associated with the label. Thus, the EQU statement defines a label with a single value, while the SET statement defines a value that is valid from the current SET statement to the point where the label occurs on the next SET statement. The use of the SET is similar to the EQU statement, but is used most often in controlling conditional assembly.

### 3.4.5 The IF and ENDIF Directives

The IF and ENDIF statements define a range of assembly language statements that are to be included or excluded during the assembly process. The form is

```
IF expression
statement#1
statement#2
...
statement#n
ENDIF
```

Upon encountering the IF statement, the assembler evaluates the expression following the IF (all operands in the expression must be defined ahead of the IF statement). If the expression evaluates to a nonzero value, then statement#1 through statement#n are assembled; if the expression evaluates to zero, the statements are listed but not assembled. Conditional assembly is often used to write a single "generic" program that includes a number of possible run-time environments, with only a few specific portions of the program selected for any particular assembly. The following program segments, for example, might be part of a program that communicates with either a teletype or a CRT console (but not both) by selecting a particular value for TTY before the assembly begins.

```
TRUE      EQU      0FFFFH      ;DEFINE VALUE OF TRUE
FALSE     EQU      NOT TRUE     ;DEFINE VALUE OF FALSE
;
TTY       EQU      TRUE        ;TRUE IF TTY, FALSE IF CRT
;
TTYBASE   EQU      10H         ;BASE OF TTY I/O PORTS
CRTBASE   EQU      20H         ;BASE OF CRT I/O PORTS
IF TTY
;ASSEMBLE RELATIVE TO
;TTYBASE
CONIN     EQU      TTYBASE     ;CONSOLE INPUT
CONOUT    EQU      TTYBASE+1   ;CONSOLE OUTPUT
ENDIF
;
IF NOT TTY
;ASSEMBLE RELATIVE TO
;CRTBASE
CONIN     EQU      CRTBASE     ;CONSOLE INPUT
CONOUT    EQU      CRTBASE+1   ;CONSOLE OUTPUT
ENDIF
...
IN        CONIN      ;READ CONSOLE DATA
...
OUT       CONOUT     ;WRITE CONSOLE DATA
```

In this case, the program would assemble for an environment where a teletype is connected, based at port 10H. The statement defining TTY could be changed to

```
TTY      EQU      FALSE
```

and, in this case, the program would assemble for a CRT based at port 20H.

### 3.4.6 The DB Directive

The DB directive allows the programmer to define initialized storage areas in single precision (byte) format. The statement form is

```
label DB e#1, e#2, ..., e#n
```

where e#1 through e#n are either expressions that evaluate to 8-bit values (the high order bit must be zero) or are ASCII strings of length no greater than 64 characters. There is no practical restriction on the number of expressions included on a single source line. The expressions are evaluated and placed sequentially into the machine code file following the last program address generated by the assembler. String characters are similarly placed into memory starting with the first character and ending with the last character. Strings of length greater than two characters cannot be used as operands in more complicated expressions. The user should note that ASCII characters are always placed in memory with the parity bit reset (0). Also, there is no translation from lower to upper case within strings. The optional label can be used to reference the data area throughout the remainder of the program. Examples of valid DB statements are

```
data:      DB      0,1,2,3,4,5
           DB      data and 0ffh,5,377Q,1+2+3+4
sign-on:   DB      'please type your name',cr,lf,0
           DB      'AB' SHR 8, 'C', 'DE' AND 7FH
```

### 3.4.7 The DW Directive

The DW statement is similar to the DB statement except double precision (two byte) words of storage are initialized. The form is

```
label      DW      e#1, e#2, ..., e#n
```

where e#1 through e#n are expressions that evaluate to 16-bit results. The user should note that ASCII strings of one or two characters are allowed, but strings longer than two characters are disallowed. In all cases, the data storage is consistent with the 8080 processor: the least significant byte of the expression is stored first in memory, followed by the most significant byte. Examples are

```
doub:      DW      0ffefh,doub+4,signon-$,255+255
           DW      'a', 5, 'ab', 'CD', 6 shl 8 or llb.
```

### 3.4.8 The DS Directive

The DS statement is used to reserve an area of uninitialized memory, and takes the form

```
label      DS      expression
```



where the label is optional. The assembler begins subsequent code generation after the area reserved by the DS. Thus, the DS statement given above has exactly the same effect as the statement

```
label:      EQU $ ;LABEL VALUE IS CURRENT CODE LOCATION
           ORG $+expression ;MOVE PAST RESERVED AREA
```

## 3.5 Operation Codes

Assembly language operation codes form the principal part of assembly language programs and form the operation field of the instruction. In general, ASM accepts all the standard mnemonics for the Intel 8080 microcomputer, which are given in detail in Intel's "8080 Assembly Language Programming Manual." Labels are optional on each input line. The individual operators are listed briefly in the following sections for completeness, although it is understood that the Intel manuals should be referenced for exact operator details. In the following tables,

- e3            represents a 3-bit value in the range 0-7 which can be one of the predefined registers A, B, C, D, E, H, L, M, SP, or PSW.
- e8            represents an 8-bit value in the range 0-255.
- e16          represents a 16-bit value in the range 0-65535.

These expressions can be formed from an arbitrary combination of operands and operators. In some cases, the operands are restricted to particular values within the allowable range, such as the PUSH instruction. These cases will be noted as they are encountered.

In the sections that follow, each operation code is listed in its most general form, along with a specific example, with a short explanation and special restrictions.

### 3.5.1 Jumps, Calls, and Returns

The Jump, Call, and Return instructions allow several different forms that test the condition flags set in the 8080 microcomputer CPU. The forms are

JMP	e16	JMP L1	Jump unconditionally to label
JNZ	e16	JNZ L2	Jump on nonzero condition to label
JZ	e16	JZ 100H	Jump on zero condition to label
JNC	e16	JNC L1+4	Jump no carry to label
JC	e16	JC L3	Jump on carry to label
JPO	e16	JPO \$+8	Jump on parity odd to label
JPE	e16	JPE L4	Jump on even parity to label
JP	e16	JP GAMMA	Jump on positive result to label
JM	e16	JM al	Jump on minus to label.
CALL	e16	CALL S1	Call subroutine unconditionally
CNZ	e16	CNZ S2	Call subroutine on nonzero condition

CZ	e16	CZ 100H	Call subroutine on zero condition
CNC	e16	CNC S1+4	Call subroutine if no carry set
CC	e16	CC S3	Call subroutine if carry set
CPO	e16	CPO \$+8	Call subroutine if parity odd
CPE	e16	CPE S4	Call subroutine if parity even
CP	e16	CP GAMMA	Call subroutine if positive result
CM	e16	CM b1\$c2	Call subroutine if minus flag.
RST	e3	RST 0	Programmed restart, equivalent to CALL 8*e3, except one byte call.
RET			Return from subroutine
RNZ			Return if nonzero flag set
RZ			Return if zero flag set
RNC			Return if no carry
RC			Return if carry flag set
RPO			Return if parity is odd
RPE			Return if parity is even
RP			Return if positive result
RM			Return if minus flag is set.

### 3.5.2 Immediate Operand Instructions

Several instructions are available that load single or double precision registers or single precision memory cells with constant values, along with instructions that perform immediate arithmetic or logical operations on the accumulator (register A).

MVI e3,e8	MVI B,255	Move immediate data to register A, B, C, D, E, H, L, or M (memory)
ADI e8	ADI 1	Add immediate operand to A without carry
ACI e8	ACI 0FFH	Add immediate operand to A with carry
SUI e8	SUI L + 3	Subtract from A without borrow (carry)
SBI e8	SBI L AND 11B	Subtract from A with borrow (carry)
ANI e8	ANI \$ AND 7FH	Logical "and" A with immediate data
XRI e8	XRI 1111\$0000B	"Exclusive or" A with immediate data
ORI e8	ORI L AND 1+1	Logical "or" A with immediate data

CPI e8	CPI 'a'	Compare A with immediate data (same as SUI except register A not changed).
LXI e3,e16	LXI B,100H	Load extended immediate to register pair (e3 must be equivalent to B,D,H, or SP).

### 3.5.3 Increment and Decrement Instructions

The 8080 provides instructions for incrementing or decrementing single and double precision registers. The instructions are

INR e3	INR E	Single precision increment register (e3 produces one of A, B, C, D, E, H, L, M)
DCR e3	DCR A	Single precision decrement register (e3 produces one of A, B, C, D, E, H, L, M)
INX e3	INX SP	Double precision increment register pair (e3 must be equivalent to B,D,H, or SP)
DCX e3	DCX B	Double precision decrement register pair (e3 must be equivalent to B,D,H, or SP).

### 3.5.4 Data Movement Instructions

Instructions that move data from memory to the CPU and from CPU to memory are given below.

MOV e3,e3	MOV A,B	Move data to leftmost element from rightmost element (e3 produces one of A,B,C,D,E,H,L, or M). MOV M,M is disallowed
LDAX e3	LDAX B	Load register A from computed address (e3 must produce either B or D)
STAX e3	STAX D	Store register A to computed address (e3 must produce either B or D)
LHLD e16	LHLD L1	Load HL direct from location e16 (double precision load to H and L)
SHLD e16	SHLD L5+x	Store HL direct to location e16 (double precision store from H and L to memory)
LDA e16	LDA Gamma	Load register A from address e16

STA e16	STA X3-5	Store register A into memory at e16
POP e3	POP PSW	Load register pair from stack, set SP (e3 must produce one of B, D, H, or PSW)
PUSH e3	PUSH B	Store register pair into stack, set SP (e3 must produce one of B, D, H, or PSW)
IN e8	IN 0	Load register A with data from port e8
OUT e8	OUT 255	Send data from register A to port e8
XTHL		Exchange data from top of stack with HL
PCHL		Fill program counter with data from HL
SPHL		Fill stack pointer with data from HL
XCHG		Exchange DE pair with HL pair

### 3.5.5 Arithmetic Logic Unit Operations

Instructions that act upon the single precision accumulator to perform arithmetic and logic operations are

ADD e3	ADD B	Add register given by e3 to accumulator without carry (e3 must produce one of A, B, C, D, E, H, or L)
ADC e3	ADC L	Add register to A with carry, e3 as above
SUB e3	SUB H	Subtract reg e3 from A without carry, e3 is defined as above
SBB e3	SBB 2	Subtract register e3 from A with carry, e3 defined as above
ANA e3	ANA 1+1	Logical "and" reg with A, e3 as above
XRA e3	XRA A	"Exclusive or" with A, e3 as above
ORA e3	ORA B	Logical "or" with A, e3 defined as above
CMP e3	CMP H	Compare register with A, e3 as above
DAA		Decimal adjust register A based upon last arithmetic logic unit operation
CMA		Complement the bits in register A

STC		Set the carry flag to 1
CMC		Complement the carry flag
RLC		Rotate bits left, (re)set carry as a side effect (high order A bit becomes carry)
RRC		Rotate bits right, (re)set carry as side effect (low order A bit becomes carry)
RAL		Rotate carry/A register to left (carry is involved in the rotate)
RAR		Rotate carry/A register to right (carry is involved in the rotate)
DAD e3	DAD B	Double precision add register pair e3 to HL (e3 must produce B, D, H, or SP).

### 3.5.6 Control Instructions

The four remaining instructions categorized as control instructions are

HLT	Halt the 8080 processor
DI	Disable the interrupt system
EI	Enable the interrupt system
NOP	No operation.

## 3.6 Error Messages

When errors occur within the assembly language program, they are listed as single character flags in the leftmost position of the source listing. The line in error is also echoed at the console so that the source listing need not be examined to determine if errors are present. The error codes are

D	Data error: element in data statement cannot be placed in the specified data area.
E	Expression error: expression is ill-formed and cannot be computed at assembly time.
L	Label error: label cannot appear in this context (may be duplicate label).
N	Not implemented: features that will appear in future ASM versions (e.g., macros) are recognized, but flagged in this version.
O	Overflow: expression is too complicated (i.e., too many pending operators) to be computed and should be simplified.
P	Phase error: label does not have the same value on two subsequent passes through the program.

- R Register error: the value specified as a register is not compatible with the operation code.
- S Syntax error: statement is not properly formed.
- V Value error: operand encountered in expression is improperly formed.

Several error messages are printed that are due to terminal error conditions:

NO SOURCE FILE PRESENT	The file specified in the ASM command does not exist on disk.
NO DIRECTORY SPACE	The disk directory is full; erase files that are not needed and retry.
SOURCE FILE NAME ERROR	Improperly formed ASM file name (e.g., it is specified with ? fields).
SOURCE FILE READ ERROR	Source file cannot be read properly by the assembler; execute a TYPE to determine the point of error.
OUTPUT FILE WRITE ERROR	Output files cannot be written properly; most likely cause is a full disk; erase and retry.
CANNOT CLOSE FILE	Output file cannot be closed; check to see if disk is write protected.

### 3.7 A Sample Session

The following session shows interaction with the assembler and debugger in the development of a simple assembly language program. The ↵ arrow represents a carriage return keystroke.

A>ASM SORT ↵ Assemble SORT.ASM

CP/M ASSEMBLER - VER 1.0

015C Next free address  
 003H USE FACTOR Percent of table used 00 to ff (hexadecimal)  
 END OF ASSEMBLY

A>DIR SORT. ↵

SORT ASM Source file  
 SORT BAK Backup from last edit  
 SORT PRN Print file (contains tab characters)  
 SORT HEX Machine code file

A>TYPE SORT.PRN ↵

```

Source line
-----
:      SORT PROGRAM IN CP/M ASSEMBLY LANGUAGE
:      START AT THE BEGINNING OF THE TRANSIENT
:      PROGRAM AREA

```

Machine code location  
 0100 ← ORG 100H

Generated machine code

```

0100 214601 SORT: LXI H,SW ;ADDRESS SWITCH TOGGLE
0103 3601 MVI M,1 ;SET TO 1 FOR FIRST ITERATION
0105 214701 LXI H,I ;ADDRESS INDEX
0108 3600 MVI M,0 ;I = 0
:
:
: COMPARE I WITH ARRAY SIZE
010A 7E COMPL: MOV A,M ;A REGISTER = I
010B FE09 CPI N-1 ;CY SET IF I < (N-1)
010D D21901 JNC CONT ;CONTINUE IF I <= (N-2)
:
:
: END OF ONE PASS THROUGH DATA
0110 214601 LXI H,SW ;CHECK FOR ZERO SWITCHES
0113 7EB7C20001 MOV A, M! ORA A! JNZ SORT ;END OF SORT IF SW=0
:
:
0118 FF RST 7 ;GO TO THE DEBUGGER INSTEAD OF REB
:
:
: CONTINUE THIS PASS
: ADDRESSING I, SO LOAD AV(I) INTO REGISTERS
Truncated
0119 5F16002148 CONT: MOV E, A! MVI D, 0! LXI H, AV! DAD D! DAD D
: MOV C, M! MOV A, C! INX H! MOV B, M
: LOW ORDER BYTE IN A AND C, HIGH ORDER BYTE IN B
:
:
: MOV H AND L TO ADDRESS AV(I+1)
0125 23 INX H
:
:
: COMPARE VALUE WITH REGS CONTAINING AV (I)
0126 965778239E SUB M! MOV D, A! MOV A, B! INX H! SBB M ;SUBTRACT
:
:
: BORROW SET IF AV(I+1) > AV(I)
012B DA3F01 JC INCI ;SKIP IF IN PROPER ORDER
:
:
: CHECK FOR EQUAL VALUES
012E B2CA3F01 ORA D! JZ INCI ;SKIP IF AV(I) = AV(I+1)
0132 56702B5E MOV D, M! MOV M, B! DCX H! MOV E, M
0136 712B722B73 MOV M, C! DCX H! MOV M, D! DCX H! MOV M, E
:
:
: INCREMENT SWITCH COUNT
013B 21460134 LXI H,SW! INR M
:
:
: INCREMENT I
013F 21470134C3INCI: LXI H,I! INR M! JMP COMP
:
:
: DATA DEFINITION SECTION
0146 00 SW: DB 0 ;RESERVE SPACE FOR SWITCH COUNT
0147 I: DS 1 ;SPACE FOR INDEX
0148 050064001EAV: DW 5, 100, 30, 50, 20, 7, 1000, 300, 100, -32767
000A = N EQU ($-AV)/2 ;COMPUTE N INSTEAD OF PRE
015C END
A>TYPE SORT.HEX Equate value

```

```

:10010000214601360121470136007EFE09D2190140
:100110002146017EB7C20001FF5F16002148011988
:10012000194E79234623965778239EDA3F01B2CAA7 } Machine code in
                                                    HEX format

```

```

:100130003F0156702B5E712B722B732146013421C7
:07014000470134C30A01006E
:10014800050064001E00320014000700E8032C01BB
:0401580064000180BE
:0000000000
A>DDT SORT.HEX/ Start debug run

```

} Machine code in  
HEX format

```

16K DDT VER 1.0
NEXT PC
015C 0000 Default address (no address on END statement)
-XP/

```

```
P=0000 100/ Change PC to 100
```

```
-UFFFF/ Untrace for 65535 steps
```

```

C0Z0M0E010 A=00 B=0000 D=0000 H=0000 S=0100 P=0100 LXI H,0146*0100
-T10/ Trace 1016 steps

```

```

C0Z0M0E010 A=01 B=0000 D=0000 H=0146 S=0100 P=0100 LXI H, 0146
C0Z0M0E010 A=01 B=0000 D=0000 H=0146 S=0100 P=0103 MVI M, 01
C0Z0M0E010 A=01 B=0000 D=0000 H=0146 S=0100 P=0105 LXI H, 0147
C0Z0M0E010 A=01 B=0000 D=0000 H=0147 S=0100 P=0108 MVI M, 00
C0Z0M0E010 A=01 B=0000 D=0000 H=0147 S=0100 P=010A MOV A, M
C0Z0M0E010 A=00 B=0000 D=0000 H=0147 S=0100 P=010B CPI 09
C1Z0M1E010 A=00 B=0000 D=0000 H=0147 S=0100 P=010D JNC 0119
C1Z0M1E010 A=00 B=0000 D=0000 H=0147 S=0100 P=0110 LXI H, 0146
C1Z0M1E010 A=00 B=0000 D=0000 H=0146 S=0100 P=0113 MOV A, M
C1Z0M1E010 A=01 B=0000 D=0000 H=0146 S=0100 P=0114 ORA A
C0Z0M0E010 A=01 B=0000 D=0000 H=0146 S=0100 P=0115 JNZ 0100
C0Z0M0E010 A=01 B=0000 D=0000 H=0146 S=0100 P=0100 LXI H, 0146
C0Z0M0E010 A=01 B=0000 D=0000 H=0146 S=0100 P=0103 MVI M, 01
C0Z0M0E010 A=01 B=0000 D=0000 H=0146 S=0100 P=0105 LXI H, 0147
C0Z0M0E010 A=01 B=0000 D=0000 H=0147 S=0100 P=0108 MVI M, 00
C0Z0M0E010 A=01 B=0000 D=0000 H=0147 S=0100 P=010A MOV A, M*010B
-A10D Stopped at 10BH/

```

```

010D JC 119/ Change to a jump on carry
0110/

```

```
-XP/
```

```
P=010B 100/ Reset program counter back to beginning of program
```

```
-T10/ Trace execution for 10H steps
```

```

C0Z0M0E010 A=00 B=0000 D=0000 H=0147 S=0100 P=0100 LXI H,0146
C0Z0M0E010 A=00 B=0000 D=0000 H=0146 S=0100 P=0103 MVI M,01
C0Z0M0E010 A=00 B=0000 D=0000 H=0146 S=0100 P=0105 LXI H,0147
C0Z0M0E010 A=00 B=0000 D=0000 H=0147 S=0100 P=0108 MVI M,00
C0Z0M0E010 A=00 B=0000 D=0000 H=0147 S=0100 P=010A MOV A,M
C0Z0M0E010 A=00 B=0000 D=0000 H=0147 S=0100 P=010B CPI 09
C1Z0M1E010 A=00 B=0000 D=0000 H=0147 S=0100 P=010D JC 0119 ← Altered instruction
C1Z0M1E010 A=00 B=0000 D=0000 H=0147 S=0100 P=0119 MOV E,A
C1Z0M1E010 A=00 B=0000 D=0000 H=0147 S=0100 P=011A MVI D,00

```



```

C1Z0M1E0I0 A=00 B=0000 D=0000 H=0147 S=0100 P=011C LXI H,0148
C1Z0M1E0I0 A=00 B=0000 D=0000 H=0148 S=0100 P=011F DAD D
C0Z0M1E0I0 A=00 B=0000 D=0000 H=0148 S=0100 P=0120 DAD D
C0Z0M1E0I0 A=00 B=0000 D=0000 H=0148 S=0100 P=0121 MOV C,M
C0Z0M1E0I0 A=00 B=0005 D=0000 H=0148 S=0100 P=0122 MOV A,C
C0Z0M1E0I0 A=05 B=0005 D=0000 H=0148 S=0100 P=1023 INX H
C0Z0M1E0I0 A=05 B=0005 D=0000 H=0149 S=0100 P=0124 MOV B,M*0125
-L100, Automatic breakpoint

```

```

0100 LXI H,0146
0103 MVI M,01
0105 LXI H,0147
0108 MVI M,00
010A MOV A,M
010B CPI 09
010D JC -0119
0110 LXI H,0146
0113 MOV A,M
0114 ORA A
0115 JNZ 0100
-L,

```

} List some code  
from 100H

```

0118 RST 07
0119 MOV E,A
011A MVI D,00
011C LXI H,0148

```

} List more

-Abort list with rubout

-G,11B, Start program from current PC (0125H) and run in real time to 11BH

\*0127 Stopped with an external interrupt 7 from front panel (program was looping indefinitely)  
-T4, Look at looping program in trace mode

```

C0Z0M0E0I0 A=38 B=0064 D=0006 H=0156 S=0100 P=0127 MOV D,A
C0Z0M0E0I0 A=38 B=0064 D=3806 H=0156 S=0100 P=0128 MOV A,B
C0Z0M0E0I0 A=00 B=0064 D=3806 H=0156 S=0100 P=0129 INX H
C0Z0M0E0I0 A=00 B=0064 D=3806 H=0157 S=0100 P=012A SBB M*012B
-D148

```

Data are sorted, but program does not stop.

```

0148 05 00 07 00 14 00 1E 00 .....
0150 32 00 64 00 64 00 2C 01 E8 03 01 80 00 00 00 00 2.D.D., .....
0160 00 00 00 00 00 00 00 00 00 00 00 00 00 00 00 .....

```

-GO, Return to CP/M

A>DDT SORT. HEX, Reload the memory image

```

16K DDT VER. 1.0
NEXT PC
015C 0000
-XP

```

P=0000 100, Set PC to beginning of program

-L10D⌘ List bad OPCODE

010D JNC 0119  
0110 LXI H,0146

-Abort list with rubout

-A10D⌘ Assemble new OPCODE

010D JC 119⌘

0110⌘

-L100⌘ List starting section of program

0100 LXI H,0146  
0103 MVI M,01  
0105 LXI H,0147  
0108 MVI M,00

-Abort list with rubout

-A103⌘ Change switch initialization to 00

0103 MVI M,0⌘

0105⌘

^C Return to CP/M with ctrl-C (GO works as well)

SAVE 1 SORT.COM⌘ Save 1 page (256 bytes, from 100H to 1ffH) on disk in case there is need to reload later

A>DDT SORT.COM⌘ Restart DDT with saved memory image

16K DDT VER 1.0

NEXT PC

0200 0100 COM file always starts with address 100H

-G⌘ Run the program from PC=100H

\*0118 Programmed stop (RST 7) encountered

-D148

0148 05 00 07 00 14 00 1E 00..... Data properly sorted

0150 32 00 64 00 64 00 2C 01 E8 03 01 80 00 00 00 00 2.D.D.....

0160 00 00 00 00 00 00 00 00 00 00 00 00 00 00 00 00.....

0170 00 00 00 00 00 00 00 00 00 00 00 00 00 00 00 00.....

-GO⌘ Return to CP/M

A>ED SORT.ASM<sub>f</sub> Make changes to original program

\*N,0 ^Z0TT<sub>f</sub> Find next ",0"  
MVI M, 0 ;I = 0

\*-<sub>f</sub> Up one line in text  
LXI H, I ;ADDRESS INDEX

\*-<sub>f</sub> Up another line  
MVI M, 1 ;SET TO 1 FOR FIRST ITERATION

\*KT<sub>f</sub> Kill line and type next line  
LXI H, I ;ADDRESS INDEX

\*I<sub>f</sub> Insert new line  
MVI M, 0 ;ZERO SW

\*T<sub>f</sub>  
LXI H, I ;ADDRESS INDEX

\*NJNC ^Z0T<sub>f</sub>  
JNC \*T<sub>f</sub>  
CONT ;CONTINUE IF I <= (N-2)

\*-2DIC ^Z0LT<sub>f</sub>  
JC CONT ;CONTINUE IF I <= (N-2)

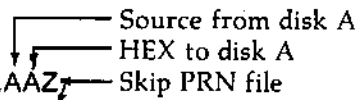
\*E<sub>f</sub>   
A>ASM SORT.AAZ<sub>f</sub>

CP/M ASSEMBLER - VER 1.0

015C Next address to assemble  
003H USE FACTOR  
END OF ASSEMBLY

A>DDT SORT.HEX<sub>f</sub> Test program changes

16K DDT VER 1.0  
NEXT PC  
015C 0000  
-G100<sub>f</sub>

\*0118  
-D148<sub>f</sub>

0148 05 00 07 00 14 00 1E 00 .....  
0150 32 00 64 00 64 00 2C 01 E8 03 01 80 00 00 00 00 2.D.D.....  
0160 00 00 00 00 00 00 00 00 00 00 00 00 00 00 00 00.....

-Abort with rubout

-G0<sub>f</sub> Return to CP/M—program checks OK.

# 4

## CP/M Dynamic Debugging Tool

### 4.1 Introduction

The DDT program allows dynamic interactive testing and debugging of programs generated in the CP/M environment. Invoke the debugger with a command of one of the following forms:

```
DDT
DDT filename.HEX
DDT filename.COM
```

where "filename" is the name of the program to be loaded and tested. In both cases, the DDT program is brought into main memory in place of the Console Command Processor (the user should refer to Chapter 5 for standard memory organization), and resides directly below the Basic Disk Operating System portion of CP/M. The BDOS starting address, located in the address field of the JMP instruction at location 5H, is altered to reflect the reduced Transient Program Area size.

The second and third forms of the DDT command perform the same actions as the first, except there is a subsequent automatic load of the specified HEX or COM file. The action is identical to the sequence of commands

```
DDT
Ifilename.HEX or Ifilename.COM
R
```

where the I and R commands set up and read the specified program to test. (The user should see the explanation of the I and R commands below for exact details.)

Upon initiation, DDT prints a sign-on message in the format

```
DDT VER m.m
```

where m.m is the revision number.

Following the sign-on message, DDT prompts the operator with the character "-" and waits for input commands from the console. The operator can type any of several single character commands, terminated by a carriage return to execute the command. Each line of input can be line-edited using the standard CP/M controls

rubout	remove the last character typed
ctl-U	remove the entire line, ready for retyping
ctl-C	system reboot.

Any command can be up to 32 characters in length (an automatic carriage return is inserted as the 33rd character), where the first character determines the command type

A	enter assembly language mnemonics with operands
D	display memory in hexadecimal and ASCII
F	fill memory with constant data
G	begin execution with optional breakpoints
I	set up a standard input file control block
L	list memory using assembler mnemonics
M	move a memory segment from source to destination
R	read program for subsequent testing
S	substitute memory values
T	trace program execution
U	untraced program monitoring
X	examine and optionally alter the CPU state.

The command character, in some cases, is followed by zero, one, two, or three hexadecimal values, which are separated by commas or single blank characters. All DDT numeric output is in hexadecimal form. The commands are not executed until the carriage return is typed at the end of the command.

At any point in the debug run, the operator can stop execution of DDT by using either a ctl-C or G0 (jmp to location 0000H), and save the current memory image by using a SAVE command of the form

SAVE n filename.COM

where n is the number of pages (256 byte blocks) to be saved on disk. The number of blocks is determined by taking the high order byte of the address in the TPA and converting this number to decimal. For example, if the highest address in the Transient Program Area is 1234H, the number of pages is 12H or 18 in decimal. The operator could type a ctl-C during the debug run, returning to the Console Command Processor level, followed by

SAVE 18 X.COM

The memory image is saved as X.COM on the diskette and can be directly executed by typing the name X. If further testing is required, the memory image can be recalled by typing

DDT X.COM

which reloads the previously saved program from location 100H through page 18 (23FFH). The CPU state is not a part of the COM file; thus, the program must be restarted from the beginning to test it properly.

## 4.2 DDT Commands

The individual commands are detailed below. In each case, the operator must wait for the prompt character (-) before entering the command. If control is passed to a program under test and the program has not reached a breakpoint, control can be returned to DDT by executing a RST 7 from the front panel. In the explanation of each command, the command letter is shown in some cases with numbers separated by commas, and the numbers are represented by lower case letters. These numbers are always assumed to be in a hexadecimal radix and from one to four digits in length (longer numbers will be automatically truncated on the right).

Many of the commands operate upon a "CPU state" that corresponds to the program under test. The CPU state holds the registers of the program being debugged and initially contains zeroes for all registers and flags except for the program counter (P) and stack pointer (S), which default to 100H. The program counter is subsequently set to the starting address given in the last record of a HEX file if a file of this form is loaded (see the I and R commands).

### 4.2.1 The A (Assembly) Command

DDT allows in-line assembly language to be inserted into the current memory image using the A command, that takes the form

As

where s is the hexadecimal starting address for the inline assembly. DDT prompts the console with the address of the next instruction to fill and reads the console, looking for assembly language mnemonics (see the Intel 8080 Assembly Language Reference Card for a list of mnemonics), followed by register references and operands in absolute hexadecimal form. Each successive load address is printed before reading the console. The A command terminates when the first empty line is input from the console.

Upon completion of assembly language input, the operator can review the memory segment using the DDT disassembler (see the L command).

The user should note that the assembler/disassembler portion of DDT can be overlaid by the transient program being tested, in which case the DDT program responds with an error condition when the A and L commands are used.

## 4.2.2 The D (Display) Command

The D command allows the operator to view the contents of memory in hexadecimal and ASCII formats. The forms are

D  
Ds  
Ds,f

In the first case, memory is displayed from the current display address (initially 100H) and continues for 16 display lines. Each display line takes the form shown below

```
aaaa bb bb bb bb bb bb bb bb bb bb bb bb bb bb bb cccccccccccccccc
```

where aaaa is the display address in hexadecimal and bb represents data present in memory starting at aaaa. The ASCII characters starting at aaaa are to the right (represented by the sequence of c's), where nongraphic characters are printed as a period (.). The user should note that both upper and lower case alphabets are displayed, and will appear as upper case symbols on a console device that supports only upper case. Each display line gives the values of 16 bytes of data, with the first line truncated so that the next line begins at an address that is a multiple of 16.

The second form of the D command is similar to the first, except that the display address is first set to address s. The third form causes the display to continue from address s through address f. In all cases, the display address is set to the first address not displayed in this command, so that a continuing display can be accomplished by issuing successive D commands with no explicit addresses.

Excessively long displays can be aborted by pushing the return key.

## 4.2.3 The F (Fill) Command

The F command takes the form

Fs,f,c

where s is the starting address, f is the final address, and c is a hexadecimal byte constant. DDT stores the constant c at address s, increments the value of s and tests against f. If s exceeds f, the operation terminates, otherwise the operation is repeated. Thus, the fill command can be used to set a memory block to a specific constant value.

## 4.2.4 The G (Go) Command

A program is executed using the G command, with up to two optional breakpoint addresses. The G command takes the forms

G  
Gs  
Gs,b  
Gs,b,c  
G,b  
G,b,c

The first form executes the program at the current value of the program counter in the current machine state, with no breakpoints set (the only way to regain control in DDT is through a RST 7 execution). The current program counter can be viewed by typing an X or XP command. The second form is similar to the first except that the program counter in the current machine state is set to address *s* before execution begins. The third form is the same as the second, except that program execution stops when address *b* is encountered (*b* must be in the area of the program under test). The instruction at location *b* is not executed when the breakpoint is encountered. The fourth form is identical to the third, except that two breakpoints are specified, one at *b* and the other at *c*. Encountering either breakpoint causes execution to stop, and both breakpoints are cleared. The last two forms take the program counter from the current machine state and set one and two breakpoints, respectively.

Execution continues from the starting address in real-time to the next breakpoint. There is no intervention between the starting address and the break address by DDT. If the program under test does not reach a breakpoint, control cannot return to DDT without executing a RST 7 instruction. Upon encountering a breakpoint, DDT stops execution and types

\*d

where *d* is the stop address. The machine state can be examined at this point using the X (Examine) command. The operator must specify breakpoints that differ from the program counter address at the beginning of the G command. Thus, if the current program counter is 1234H, then the commands

G,1234

and

G400,400

both produce an immediate breakpoint without executing any instructions.

## 4.2.5 The I (Input) Command

The I command allows the operator to insert a file name into the default file control block at 5CH (the file control block created by CP/M for transient programs is placed at this location; see Chapter 5). The default FCB can be used by the program under test as if it had been passed by the CP/M Console Processor. The user should note that this file name is also used by DDT for reading additional HEX and COM files. The form of the I command is

Ifilename

or

Ifilename.typ

If the second form is used and the filetype is either HEX or COM, subsequent R commands can be used to read the pure binary or hex format machine code. (Section 4.2.8 gives further details.)



## 4.2.6 The L (List) Command

The L command is used to list assembly language mnemonics in a particular program region. The forms are

L  
Ls  
Ls,f

The first form lists twelve lines of disassembled machine code from the current list address. The second form sets the list address to s and then lists twelve lines of code. The last form lists disassembled code from s through address f. In all three cases, the list address is set to the next unlisted location in preparation for a subsequent L command. Upon encountering an execution breakpoint, the list address is set to the current value of the program counter (G and T commands). Again, long typeouts can be aborted using the return key during the list process.

## 4.2.7 The M (Move) Command

The M command allows block movement of program or data areas from one location to another in memory. The form is

Ms,f,d

where s is the start address of the move, f is the final address, and d is the destination address. Data are first removed from s to d, and both addresses are incremented. If s exceeds f, the move operation stops; otherwise, the move operation is repeated.

## 4.2.8 The R (Read) Command

The R command is used in conjunction with the I command to read COM and HEX files from the diskette into the transient program area in preparation for the debug run. The forms are

R  
Rb

where b is an optional bias address that is added to each program or data address as it is loaded. The load operation must not overwrite any of the system parameters from 000H through 0FFH (i.e., the first page of memory). If b is omitted, then b=0000 is assumed. The R command requires a previous I command, specifying the name of a HEX or COM file. The load address for each record is obtained from each individual HEX record, while an assumed load address of 100H is used for COM files. The user should note that any number of R commands can be issued following the I command to reread the program under test, assuming the tested program does not destroy the default area at 5CH. Any file specified with the filetype "COM" is assumed to contain machine code in pure binary form (created with the LOAD or SAVE command), and all others are assumed to contain machine code in Intel hex format (produced, for example, with the ASM command.)

Recall that the command

```
DDT filename.filetype
```

which initiates the DDT program, is equivalent to the commands

```
DDT  
-lfilename.filetype  
-R
```

Whenever the R command is issued, DDT responds with either the error indicator "?" (file cannot be opened, or a checksum error occurred in a HEX file), or with a load message taking the form

```
NEXT PC  
nnnn pppp
```

where nnnn is the next address following the loaded program and pppp is the assumed program counter (100H for COM files, or taken from the last record if a HEX file is specified).

#### 4.2.9 The S (Set) Command

The S command allows memory locations to be examined and optionally altered. The form of the command is

```
Ss
```

where s is the hexadecimal starting address for examination and alteration of memory. DDT responds with a numeric prompt, giving the memory location, along with the data currently held in memory. If the operator types a carriage return, the data are not altered. If a byte value is typed, the value is stored at the prompted address. In either case, DDT continues to prompt with successive addresses and values until either a period (.) is typed by the operator or an invalid input value is detected.

#### 4.2.10 The T (Trace) Command

The T command allows selective tracing of program execution for 1 to 65535 program steps. The forms are

```
T  
Tn
```

In the first case, the CPU state is displayed and the next program step is executed. The program terminates immediately, with the termination address displayed as

```
*hhhh
```

where hhhh is the next address to execute. The display address (used in the D command) is set to the value of H and L, and the list address (used in the L command) is set to hhhh. The CPU state at program termination can then be examined using the X command.

The second form of the T command is similar to the first, except that execution is traced for n steps (n is a hexadecimal value) before a program breakpoint occurs. A breakpoint can be forced in the trace mode by typing a rubout character. The CPU state is displayed before each program step is taken in trace mode. The format of the display is the same as described in the X command.

The user should note that program tracing is discontinued at the CP/M interface and resumes after return from CP/M to the program under test. Thus, CP/M functions that access I/O devices, such as the diskette drive, run in real-time, avoiding I/O timing problems. Programs running in trace mode execute approximately 500 times slower than real-time since DDT gets control after each user instruction is executed. Interrupt processing routines can be traced, but commands that use the breakpoint facility (G, T, and U) accomplish the break using an RST 7 instruction, which means that the tested program cannot use this interrupt location. Further, the trace mode always runs the tested program with interrupts enabled, which may cause problems if asynchronous interrupts are received during tracing.

The operator should use the return key to get control back to DDT during trace, rather than executing an RST 7, to ensure that the trace for current instruction is completed before interruption.

### 4.2.11 The U (Untrace) Command

The U command is identical to the T command except that intermediate program steps are not displayed. The untrace mode allows from 1 to 65535 (0FFFFH) steps to be executed in monitored mode and is used principally to retain control of an executing program while it reaches steady state conditions. All conditions of the T command apply to the U command.

### 4.2.12 The X (Examine) Command

The X command allows selective display and alteration of the current CPU state for the program under test. The forms are

X  
Xr

where r is one of the 8080 CPU registers

C	Carry flag	(0/1)
Z	Zero flag	(0/1)
M	Minus flag	(0/1)
E	Even parity flag	(0/1)
I	Interdigit carry	(0/1)
A	Accumulator	(0-FF)
B	BC register pair	(0-FFFF)
D	DE register pair	(0-FFFF)
H	HL register pair	(0-FFFF)
S	Stack pointer	(0-FFFF)
P	Program counter	(0-FFFF)

In the first case, the CPU register state is displayed in the format

```
CfZfMfEfIf A=bb B=dddd D=dddd H=dddd S=dddd P=dddd inst
```

where *f* is a 0 or 1 flag value, *bb* is a byte value, and *dddd* is a double-byte quantity corresponding to the register pair. The "inst" field contains the disassembled instruction, which occurs at the location addressed by the CPU state's program counter.

The second form allows display and optional alteration of register values, where *r* is one of the registers given above (C, Z, M, E, I, A, B, D, H, S, or P). In each case, the flag or register value is first displayed at the console. The DDT program then accepts input from the console. If a carriage return is typed, the flag or register value is not altered. If a value in the proper range is typed, the flag or register value is altered. The user should note that BC, DE, and HL are displayed as register pairs. Thus, the operator types the entire register pair when B, C, or the BC pair is altered.

### 4.3 Implementation Notes

The organization of DDT allows certain nonessential portions to be overlaid to gain a larger transient program area for debugging large programs. The DDT program consists of two parts: the DDT nucleus and the assembler/disassembler module. The DDT nucleus is loaded over the Console Command Processor, and, although loaded with the DDT nucleus, the assembler/disassembler is overlayable unless used to assemble or disassemble.

In particular, the BDOS address at location 6H (address field of the JMP instruction at location 5H) is modified by DDT to address the base location of the DDT nucleus, which, in turn, contains a JMP instruction to the BDOS. Thus, programs that use this address field to size memory see the logical end of memory at the base of the DDT nucleus rather than the base of the BDOS.

The assembler/disassembler module resides directly below the DDT nucleus in the transient program area. If the A, L, T, or X commands are used during the debugging process, the DDT program again alters the address field at 6H to include this module, further reducing the logical end of memory. If a program loads beyond the beginning of the assembler/disassembler module, the A and L commands are lost (their use produces a "?" in response) and the trace and display (T and X) commands list the "inst" field of the display in hexadecimal, rather than as a decoded instruction.

## 4.4 An Example

The following example shows an edit, assemble, and debug for a simple program that reads a set of data values and determines the largest value in the set. The largest value is taken from the vector and stored into "LARGE" at the termination of the program

```
A>ED SCAN.ASM          Create source program;
                        "↵" represents carriage return.

*↵
                                ORG      1-00H      ;START OF TRANSIENT
                                                ;AREA ↵
                                MVI      B, LEN      ;LENGTH OF VECTOR TO SCAN↵
                                MVI      C, 0        ;LARGER_RST VALUE SO FAR↵
LOOP:                            LXI      H, VECT    ;BASE OF VECTOR↵
LOOP:                            MOV      A, M      ;GET VALUE↵
                                SUB      C          ;LARGER VALUE IN C?↵
                                JNC      NFOUND      ;JUMP IF LARGER VALUE NOT
                                                ;FOUND↵
;                                NEW LARGEST VALUE, STORE IT TO C ↵
NFOUND:                          MOV      C, A
                                INX      H          ;TO NEXT ELEMENT↵
                                DCR      B          ;MORE TO SCAN?↵
                                JNZ      LOOP        ;FOR ANOTHER ↵
;
;                                END OF SCAN, STORE C ↵
                                MOV      A, C        ;GET LARGEST VALUE ↵
                                STA      LARGE↵
                                JMP      0          ;REBOOT↵
;↵
;↵
                                TEST DATA
VECT:                            DB          2,0,4,3,5,6,1,5
LEN                               EQU      $-VECT    ;LENGTH
LARGE:                            DS          1        ;LARGEST VALUE ON EXIT↵
                                END↵

I-Z
*B0P↵

                                ORG      100H        ;START OF TRANSIENT AREA
                                MVI      B, LEN      ;LENGTH OF VECTOR TO SCAN
                                MVI      C, 0        ;LARGER VALUE SO FAR
                                LXI      H, VECT    ;BASE OF VECTOR
LOOP:                            MOV      A, M      ;GET VALUE
                                SUB      C          ;LARGER VALUE IN C?
                                JNC      NFOUND      ;JUMP IF LARGER VALUE NOT
                                                ;FOUND
;                                NEW LARGEST VALUE, STORE IT TO C
NFOUND:                          MOV      C, A
                                INX      H          ;TO NEXT ELEMENT
                                DCR      B          ;MORE TO SCAN?
                                JNZ      LOOP        ;FOR ANOTHER
;                                END OF SCAN, STORE C
                                MOV      A, C        ;GET LARGEST VALUE
                                STA      LARGE
                                JMP      0          ;REBOOT
;
;                                TEST DATA
```

```

VECT:          DB      2,0,4,3,5,6,1,5
LEN            EQU     $-VECT      ;LENGTH
LARGE:        DS      1            ;LARGEST VALUE ON EXIT
END

```

\*E ↙ ← End of edit

A>ASM SCAN ↙ Start Assembler

CP/M ASSEMBLER - VER 1.0

0122

002H USE FACTOR

END OF ASSEMBLY Assembly complete; lock at program listing

A>TYPE SCAN.PRN ↙

Code address	Source program	
0100 ↙		ORG 100H ;START OF TRANSIENT AREA
0100 0608		MVI B,LEN ;LENGTH OF VECTOR TO SCAN
0102 0E00	Machine code	MVI C,0 ;LARGEST VALUE SO FAR
0104 211901		LXI H,VECT. ;BASE OF VECTOR
0107 7E	LOOP:	MOV A,M ;GET VALUE
0108 91		SUB C ;LARGER VALUE IN C?
0109 D20D01		JNC NFOUND ;JUMP IF LARGER VALUE NOT ;FOUND
		; NEW LARGEST VALUE, STORE IT TO C
010C 4F		MOV C, A
010D 23	NFOUND:	INX H ;TO NEXT ELEMENT
010E 05		DCR B ;MORE TO SCAN?
010F C20701		JNZ LOOP ;FOR ANOTHER
		; END OF SCAN, STORE C
0112 79		MOV A, C ;GET LARGEST VALUE
0113 322101		STA LARGE
0116 C30000		JMP 0 ;REBOOT
	Code—data listing ;	
	truncated ↙	TEST DATA
0119 0200040305 ↙	VECT:	DB 2,0,4,3,5,6,1,5
0008 = Value of	LEN	EQU \$-VECT ;LENGTH
0121 equate	LARGE:	DS 1 ;LARGEST VALUE ON EXIT
0122		END

A>DDT SCAN.HEX ↙ Start debugger using hex format machine code

DDT VER 1.0

NEXT PC

0121 0000

-X ↙ Last load address + 1

Next instruction  
to execute at  
PC=0 ↙

C0Z0M0E0I0 A=00 B=0000 D=0000 H=0000 S=0100 P=0000 OUT 7F

-XP ↙ Examine registers before debug run

P=0000 100 ↙ Change PC to 100

-X ↙ Look at registers again

COZOM0E010 A=00 B=0000 D=0000 H=0000 S=0100 P=0100 MVI B,08  
 -L100/ PC changed. Next instruction to execute at PC=100

0100	MVI	B,08	} Disassembled machine code at 100H (see source listing for comparison)
0102	MVI	C,00	
0104	LXI	H,0119	
0107	MOV	A,M	
0108	SUB	C	
0109	JNC	010D	
010C	MOV	C,A	
010D	INX	H	
010E	DCR	B	
010F	JNZ	0107	
0112	MOV	A,C	

-L/			
0113	STA	0121	} A little more machine code. Note that program ends at location 116 with a JMP to 0000. Remainder of listing is assembly of data.
0116	JMP	0000	
0119	STAX	B	
011A	NOP		
011B	INR	B	
011C	INX	B	
011D	DCR	B	
011E	MVI	B,01	
0120	DCR	B	
0121	LXI	D,2200	
0124	LXI	H,0200	

-A116/ Enter in-line assembly mode to change the JMP to 0000 into a RST 7, which will cause the program under test to return to DDT if 116H is ever executed.  
 0116 RST 7

0117/ (Single carriage return stops assemble mode)

-L113/ List code at 113H to check that RST 7 was properly inserted

0113	STA	0121	
0116	RST	07	in place of JMP
0117	NOP		
0118	NOP		
0119	STAX	B	
011A	NOP		
011B	INR	B	
011C	INX	B	

-X/ Look at registers

COZOM0E010 A=00 B=0000 D=0000 H=0000 S=0100 P=0100 MVI B,08

-T/ Execute Program for one stop. Initial CPU state, before / is executed

COZOM0E010 A=00 B=0000 D=0000 H=0000 S=0100 P=0100 MVI B,08\*0102

-T/ Automatic breakpoint

Trace one step again (note 08H in B)

C0Z0M0E010 A=00 B=0800 D=0000 H=0000 S=0100 P=0102 MVI C,00\*0104

-T

Trace again (Register C is cleared)

C0Z0M0E010 A=00 B=0800 D=0000 H=0000 S=0100 P=0104 LXI H,0119\*0107

-T3 Trace three steps

C0Z0M0E010 A=00 B=0800 D=0000 H=0119 S=0100 P=0107 MOV A,M

C0Z0M0E010 A=02 B=0800 D=0000 H=0119 S=0100 P=0108 SUB C

C0Z0M0E011 A=02 B=0800 D=0000 H=0119 S=0100 P=0109 JNC 010D\*010D

-D119

Display memory starting at 119H. Automatic breakpoint at 10DH

```

0119 02 00 04 03 05 06 01) Program data
0120 05 11 00 22 21 00 02 7E EB 77 13 23 EB 0B 78 B1 ... "!... W. #. (X)
0130 C2 27 01 C3 03 29 00 00 00 00 00 00 00 00 00 00 .....
0140 00 00 00 00 00 00 00 00 00 00 00 00 00 00 00 .....
0150 00 00 00 00 00 00 00 00 00 00 00 00 00 00 00 .....
0160 00 00 00 00 00 00 00 00 00 00 00 00 00 00 00 Data are displayed
0170 00 00 00 00 00 00 00 00 00 00 00 00 00 00 00 in ASCII with a "
0180 00 00 00 00 00 00 00 00 00 00 00 00 00 00 00 in the position of
0190 00 00 00 00 00 00 00 00 00 00 00 00 00 00 00 nongraphic
01A0 00 00 00 00 00 00 00 00 00 00 00 00 00 00 00 characters
01B0 00 00 00 00 00 00 00 00 00 00 00 00 00 00 00 .....
01C0 00 00 00 00 00 00 00 00 00 00 00 00 00 00 00 .....

```

-X

Current CPU state

C0Z0M0E011 A=02 B=0800 D=0000 H=0119 S=0100 P=010D INX H

-T5

Trace 5 steps from current CPU state

C0Z0M0E011 A=02 B=0800 D=0000 H=0119 S=0100 P=010D INX H

C0Z0M0E011 A=02 B=0800 D=0000 H=011A S=0100 P=010E DCR B

C0Z0M0E011 A=02 B=0700 D=0000 H=011A S=0100 P=010F JNZ 0107

C0Z0M0E011 A=02 B=0700 D=0000 H=011A S=0100 P=0107 MOV A,M

C0Z0M0E011 A=00 B=0700 D=0000 H=011A S=0100 P=0108 SUB C\*0109

U5

Trace without listing intermediate states

Automatic breakpoint

C0Z1M0E111 A=00 B=0700 D=0000 H=011A S=0100 P=0109 JNC 010D\*0108

-X

CPU state at end of U5

C0Z0M0E111 A=04 B=0600 D=0000 H=011B S=0100 P=0108 SUB C

-G Run program from current PC until completion (in real-time)

\*0116 breakpoint at 116H, caused by executing RST 7 in machine code.

-X

CPU state at end of program

C0Z1M0E111 A=00 B=0000 D=0000 H=0121 S=0100 P=0116 RST 07

-XP

Examine and change program counter

P=0116 100

-X

C0Z1M0E111 A=00 B=0000 D=0000 H=0121 S=0100 P=0100 MVI B,08

-T10



	Trace 10 (hexadecimal) steps	First data element	Current largest value	Subtract for comparison	C				
	C0Z1M0E111	A=00	B=0800	D=0000	H=0121	S=0100	P=0100	MVI B,08	
	C0Z1M0E111	A=00	B=0000	D=0000	H=0121	S=0100	P=0102	MVI C,00	
	C0Z1M0E111	A=00	B=0800	D=0000	H=0121	S=0100	P=0104	LXI H,0119	
	C0Z1M0E111	A=00	B=0800	D=0000	H=0119	S=0100	P=0107	MOV A,M	
	C0Z1M0E111	A=02	B=0800	D=0000	H=0119	S=0100	P=0108	SUB C	
	C0Z0M0E011	A=02	B=0800	D=0000	H=0119	S=0100	P=0109	JNC 010D	
	C0Z0M0E011	A=02	B=0800	D=0000	H=0119	S=0100	P=010D	INX H	
	C0Z0M0E011	A=02	B=0800	D=0000	H=011A	S=0100	P=010E	DCR B	
	C0Z0M0E011	A=02	B=0700	D=0000	H=011A	S=0100	P=010F	JNZ 0107	
	C0Z0M0E011	A=02	B=0700	D=0000	H=011A	S=0100	P=0107	MOV A,M	
	C0Z0M0E011	A=00	B=0700	D=0000	H=011A	S=0100	P=0108	SUB C	
	C0Z1M0E111	A=00	B=0700	D=0000	H=011A	S=0100	P=0109	JNC 010D	
	C0Z1M0E111	A=00	B=0700	D=0000	H=011A	S=0100	P=010D	INX H	
	C0Z1M0E111	A=00	B=0700	D=0000	H=011B	S=0100	P=010E	DCR B	
	C0Z0M0E111	A=00	B=0600	D=0000	H=011B	S=0100	P=010F	JNZ 0107	
	C0Z0M0E111	A=00	B=0600	D=0000	H=011B	S=0100	P=0107	MOV A,M*0108	
	-A109								Insert a "hot patch" into the machine code to change the JNC to JC
	0109	JC 10D							Program should have moved the value from A into C since A>C. Since this code was not executed, it appears that the JNC should have been a JC instruction
	010C								
	-G0								Stop DDT so that a version of the patched program can be saved
	A>SAVE 1 SCAN.COM								Program resides on first page, so save 1 page.
	A>DDT SCAN.COM								Restart DDT with the save memory image to continue testing
	DDT VER 1.0								
	NEXT PC								
	0200 0100								
	-L100								List some code
	0100	MVI B,08							
	0102	MVI C,00							
	0104	LXI H,0119							
	0107	MOV A,M							
	0108	SUB C							
	0109	JC 010D							Previous patch is present in X.COM
	010C	MOV C,A							
	010D	INX H							
	010E	DCR B							
	010F	JNZ 0107							
	0112	MOV A,C							
	-XP								
	P=0100								

-T10 ↙ Trace to see how patched version operates Data is moved from A to C

```

C0Z0M0E010 A=00 B=0000 D=0000 H=0000 S=0100 P=0100 MVI B,08
C0Z0M0E010 A=00 B=0800 D=0000 H=0000 S=0100 P=0102 MVI C,00
C0Z0M0E010 A=00 B=0800 D=0000 H=0000 S=0100 P=0104 LXI H,0119
C0Z0M0E010 A=00 B=0800 D=0000 H=0119 S=0100 P=0107 MOV A,M
C0Z0M0E010 A=02 B=0800 D=0000 H=0119 S=0100 P=0108 SUB C
C0Z0M0E011 A=02 B=0800 D=0000 H=0119 S=0100 P=0109 JC 010D
C0Z0M0E011 A=02 B=0800 D=0000 H=0119 S=0100 P=010C MOV C,A
C0Z0M0E011 A=02 B=0802 D=0000 H=0119 S=0100 P=010D INX H
C0Z0M0E011 A=02 B=0802 D=0000 H=011A S=0100 P=010E DCR B
C0Z0M0E011 A=02 B=0702 D=0000 H=011A S=0100 P=010F JNZ 0107
C0Z0M0E011 A=02 B=0702 D=0000 H=011A S=0100 P=0107 MOV A,M
C0Z0M0E011 A=00 B=0702 D=0000 H=011A S=0100 P=0108 SUB C
C1Z0M1E010 A=FE B=0702 D=0000 H=011A S=0100 P=0109 JC 010D
C1Z0M1E010 A=FE B=0702 D=0000 H=011A S=0100 P=010D INX H
C1Z0M1E010 A=FE B=0702 D=0000 H=011B S=0100 P=010E DCR B
C1Z0M0E111 A=FE B=0602 D=0000 H=011B S=0100 P=010F JNZ 0107*0107
-X ↙ Breakpoint after 16 steps ↗

```

C1Z0M0E111 A=FE B=0602 D=0000 H=011B S=0100 P=0107 MOV A,M  
-G,108 ↙ Run from current PC and breakpoint at 108H

\*0108

-X ↙

C1Z0M0E111 A=04 B=0602 D=0000 H=011B S=0100 P=0108 SUB C  
↖ Next data item

-T ↙

Single step for a few cycles

C1Z0M0E111 A=04 B=0602 D=0000 H=011B S=0100 P=0108 SUB C\*0109

-T ↙

C0Z0M0E011 A=02 B=0602 D=0000 H=011B S=0100 P=0109 JC 010D\*010C

-X ↙

C0Z0M0E011 A=02 B=0602 D=0000 H=011B S=0100 P=010C MOV C,A

-G ↙ Run to completion

\*0116

-X ↙

C0Z1M0E111 A=03 B=0003 D=0000 H=0121 S=0100 P=0116 RST 07

-S121 ↙ Look at the value of "LARGE"

0121 03 ↙ Wrong value!

0122 00 ↙

0123 22 ↙

0124 21 ↙

```

0125 00f
0126 02f
0127 7Ef  End of the S command

```

-L100f

```

0100 MVI      B,08
0102 MVI      C,00
0104 LXI      H,0119
0107 MOV      A,M
0108 SUB      C
0109 JC       010D
010C MOV      C,A
010D INX      H
010E DCR      B
010F JNZ      0107
0112 MOV      A,C

```

-L f

```

0113 STA      0121
0116 RST      07
0117 NOP
0118 NOP
0119 STAX     B
011A NOP
011B INR      B
011C INX      B
011D DCR      B
011E MVI      B,01
0120 DCR      B

```

} Review the code

-XPf

P=0116 100f Reset the PC

-Tf

Single step, and watch data values

C0Z1M0E111 A=03 B=0003 D=0000 H=0121 S=0100 P=0100 MVI B,08\*0102

-Tf

C0Z1M0E111 A=03 B=0803 D=0000 H=0121 S=0100 P=0102 MVI C,00\*0104

-Tf

Count set      "Largest" set

C0Z1M0E111 A=03 B=0800 D=0000 H=0121 S=0100 P=0104 LXI H,0119\*0107

-Tf

Base address of data set

C0Z1M0E111 A=03 B=0800 D=0000 H=0119 S=0100 P=0107 MOV A,M\*0108

-Tf

First data item brought to A

C0Z1M0E111 A=02 B=0800 D=0000 H=0119 S=0100 P=0108 SUB C\*0109

-Tf

C0Z0M0E011 A=02 B=0800 D=0000 H=0119 S=0100 P=0109 JC 010D\*010C

-Tf

C0Z0M0E0I1 A=02 B=0800 D=0000 H=0119 S=0100 P=010C MOV C,A\*010D  
-T

C0Z0M0E0I1 A=02 B=0802 D=0000 H=0119 S=0100 P=010D INX H\*010E  
-T

↙ First data item moved to C correctly

C0Z0M0E0I1 A=02 B=0802 D=0000 H=011A S=0100 P=010E DCR B\*010F  
-T

C0Z0M0E0I1 A=02 B=0702 D=0000 H=011A S=0100 P=010F JNZ 0107\*0107  
-T

C0Z0M0E0I1 A=02 B=0702 D=0000 H=011A S=0100 P=0107 MOV A,M\*0108  
-T

C0Z0M0E0I1 A=00 B=0702 D=0000 H=011A S=0100 P=0108 SUB C\*0109  
-T

↙ Second data item brought to A

C1Z0M1E0I0 A=FE B=0702 D=0000 H=011A S=0100 P=0109 JC 010D\*010D  
-T

↙ Subtract destroys data value that was loaded!

C1Z0M1E0I0 A=FE B=0702 D=0000 H=011A S=0100 P=010D INX H\*010E  
-L100

0100	MVI	B,08
0102	MVI	C,00
0104	LXI	H,0119
0107	MOV	A,M
0108	SUB	C
0109	JC	010D
010C	MOV	C,A
010D	INX	H
010E	DCR	B
010F	JNZ	0107
0112	MOV	A,C

← This should have been a CMP so that register A would not be destroyed.

-A108

0108 CMP C Hot patch at 108H changes SUB to CMP

0109

-G0 Stop DDT for SAVE

A>SAVE 1 SCAN.COM Save memory image

A>DDT SCAN.COM Restart DDT

DDT VER 1.0

NEXT PC

0200 0100

-XP

P=0100

-L116

```

0116 RST      07
0117 NOP
0118 NOP
0119 STAX    B
011A NOP

```

} Look at code to see if it was properly loaded  
(long typeout aborted with rubout)

-G,116 ↵ Run from 100H to completion

\*0116

-XC ↵ Look at carry (accidental typo)

C1 ↵

-X ↵ Look at CPU state

C1Z1M0E111 A=06 B=0006 D=0000 H=0121 S=0100 P=0116 RST 07

-S121 ↵ Look at "large"—it appears to be correct.

0121 06 ↵

0122 00 ↵

0123 22

-G0 ↵ Stop DDT

A>ED SCAN.ASM ↵ Re-edit the source program, and make both changes

\*NSUB ↵

\*0LT ↵

ctl-Z ↵ SUB C ;LARGER VALUE IN C?

\*SSUB|ZCMP|Z0LT ↵  
CMP C ;LARGER VALUE IN C?

\* JNC NFOUND ;JUMP IF LARGER VALUE NOT FOUND

\*SNC|ZC|Z0LT ↵  
JC NFOUND ;JUMP IF LARGER VALUE NOT FOUND

\*E ↵

Re-assemble, selecting source from disk A

A>ASM SCAN.AAZ ↵ ←Hex to disk A

Print to Z (selects no print file)

CP/M ASSEMBLER VER 1.0

0122

002H USE FACTOR

END OF ASSEMBLY

A>DDT SCAN.HEX ↵ Re-run debugger to check changes

DDT VER 1.0

NEXT PC

0121 0000

-L116 ↵

0116 JMP 0000 Check to ensure end is still at 116H

0119 STAX B

011A NOP

011B INR B

- (rubout)

-G100,116 ↵ Go from beginning with breakpoint at end

\*0116 Breakpoint reached

-D121 ↵ Look at "LARGE"

0121 06 00 22 21 00 02 7E EB 77 13 23 EB 0B 78 B1 .. '!...W.#...X.  
0130 C2 27 01 C3 03 29 00 00 00 00 00 00 00 00 00 00 .'...)).....  
0140 00 00 00 00 00 00 00 00 00 00 00 00 00 00 00 00 .....

- (rubout) Aborts long type-out

G0 ↵ Stop DDT, debug session complete.



# 5

## CP/M 2 System Interface

### 5.1 Introduction

This chapter describes CP/M, release 2, system organization including the structure of memory and system entry points. The intention is to provide necessary information required to write programs that operate under CP/M and that use the peripheral and disk I/O facilities of the system.

CP/M is logically divided into four parts, called the Basic I/O System (BIOS), the Basic Disk Operating System (BDOS), the Console Command Processor (CCP), and the Transient Program Area (TPA). The BIOS is a hardware-dependent module that defines the exact low level interface with a particular computer system that is necessary for peripheral device I/O. Although a standard BIOS is supplied by Digital Research, explicit instructions are provided for field reconfiguration of the BIOS to match nearly any hardware environment (see Chapter 6). The BIOS and BDOS are logically combined into a single module with a common entry point and referred to as the FDOS. The CCP is a distinct program that uses the FDOS to provide a human-oriented interface with the information that is cataloged on the backup storage device. The TPA is an area of memory (i.e., the portion that is not used by the FDOS and CCP) where various nonresident operating system commands and user programs are executed. The lower portion of memory is reserved for system information and is detailed in later sections. Memory organization of the CP/M system is shown below.

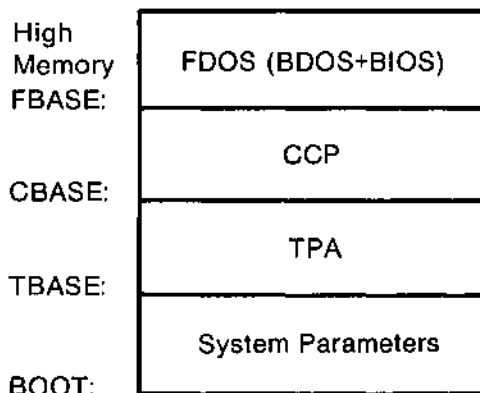



The exact memory addresses corresponding to BOOT, TBASE, CBASE, and FBASE vary from version to version and are described fully in Chapter 6. All standard CP/M versions, however, assume BOOT = 0000H, which is the base of random access memory. The machine code found at location BOOT performs a system "warm start," which loads and initializes the programs and variables necessary to return control to the CCP. Thus, transient programs need only jump to location BOOT to return control to CP/M at the command level. Further, the standard versions assume TBASE = BOOT+0100H, which is normally location 0100H. The principal entry point to the FDOS is at location BOOT+0005H (normally 0005H) where a jump to FBASE is found. The address field at BOOT+0006H (normally 0006H) contains the value of FBASE and can be used to determine the size of available memory, assuming that the CCP is being overlaid by a transient program.

Transient programs are loaded into the TPA and executed as follows. The operator communicates with the CCP by typing command lines following each prompt. Each command line takes one of the forms:

```
command
command file1
command file1 file2
```

where "command" is either a built-in function such as DIR or TYPE or the name of a transient command or program. If the command is a built-in function of CP/M, it is executed immediately. Otherwise, the CCP searches the currently addressed disk for a file by the name

```
command.COM
```

If the file is found, it is assumed to be a memory image of a program that executes in the TPA and thus implicitly originates at TBASE in memory. The CCP loads the COM file from the disk into memory starting at TBASE and can extend up to CBASE.

If the command is followed by one or two file specifications, the CCP prepares one or two file control block (FCB) names in the system parameter area. These optional FCBs are in the form necessary to access files through the FDOS and are described in the next section.

The transient program receives control from the CCP and begins execution, using the I/O facilities of the FDOS. The transient program is "called" from the CCP. Thus, it can simply return to the CCP upon completion of its processing or can jump to BOOT to pass control back to CP/M. In the first case, the transient program must not use memory above CBASE, while in the latter case, memory up through FBASE-1 can be used.

The transient program can use the CP/M I/O facilities to communicate with the operator's console and peripheral devices, including the disk subsystem. The I/O system is accessed by passing a function number and an information address to CP/M through the FDOS entry point at BOOT+0005H. In the case of a disk read, for example, the transient program sends the number corresponding to a disk read, along with the address of an FCB to the CP/M FDOS. The FDOS, in turn, performs the operation and returns with either a disk read completion indication or an error number indicating that the disk read was unsuccessful.

## 5.2 Operating System Call Conventions

This section provides detailed information for performing direct operating system calls from user programs. Many of the functions listed below, however, are accessed more simply through the I/O macro library provided with the MAC macro assembler and listed in the Digital Research manual entitled, *MAC Macro Assembler: Language Manual and Applications Guide*.

CP/M facilities that are available for access by transient programs fall into two general categories: simple device I/O and disk file I/O. The simple device operations include:

- Read a Console Character
- Write a Console Character
- Read a Sequential Tape Character
- Write a Sequential Tape Character
- Write a List Device Character
- Get or Set I/O Status
- Print Console Buffer
- Read Console Buffer
- Interrogate Console Ready

The FDOS operations that perform disk I/O are

- Disk System Reset
- Drive Selection
- File Creation
- File Open
- File Close
- Directory Search
- File Delete
- File Rename
- Random or Sequential Read
- Random or Sequential Write
- Interrogate Available Disks
- Interrogate Selected Disk
- Set DMA Address
- Set/Reset File Indicators.

As mentioned above, access to the FDOS functions is accomplished by passing a function number and information address through the primary point at location BOOT+0005H. In general, the function number is passed in register C with the information address in the double byte pair DE. Single byte values are returned in register A, with double byte values returned in HL (a zero value is returned when the function number is out of range). For reasons of compatibility, register A = L and register B = H upon return in all cases. The user should note that the register passing conventions of CP/M agree with those of Intel's PL/M systems programming language. CP/M functions and their numbers are listed below.

0	System Reset	19	Delete File
1	Console Input	20	Read Sequential
2	Console Output	21	Write Sequential
3	Reader Input	22	Make File
4	Punch Output	23	Rename File
5	List Output	24	Return Login Vector
6	Direct Console I/O	25	Return Current Disk
7	Get I/O Byte	26	Set DMA Address
8	Set I/O Byte	27	Get Addr(Alloc)
9	Print String	28	Write Protect Disk
10	Read Console Buffer	29	Get R/O Vector
11	Get Console Status	30	Set File Attributes
12	Return Version Number	31	Get Addr(Disk Parms)
13	Reset Disk System	32	Set/Get User Code
14	Select Disk	33	Read Random
15	Open File	34	Write Random
16	Close File	35	Compute File Size
17	Search for First	36	Set Random Record
18	Search for Next	37	Reset Drive
		40	Write Random with Zero Fill

(Functions 28 and 32 should be avoided in application programs to maintain upward compatibility with CP/M.)

Upon entry to a transient program, the CCP leaves the stack pointer set to an eight-level stack area with the CCP return address pushed onto the stack, leaving seven levels before overflow occurs. Although this stack is usually not used by a transient program (i.e., most transients return to the CCP through a jump to location 0000H), it is sufficiently large to make CP/M system calls since the FDOS switches to a local stack at system entry. The assembly language program segment below, for example, reads characters continuously until an asterisk is encountered, at which time control returns to the CCP (assuming a standard CP/M system with BOOT = 0000H).

```

BDOS      EQU      0005H      ;STANDARD CP/M ENTRY
CONIN     EQU      1         ;CONSOLE INPUT FUNCTION
;
NEXTC:    ORG      0100H      ;BASE OF TPA
          MVI     C,CONIN    ;READ NEXT CHARACTER
          CALL   BDOS        ;RETURN CHARACTER IN <A>
          CPI     "*"        ;END OF PROCESSING?
          JNZ    NEXTC      ;LOOP IF NOT
          RET                     ;RETURN TO CCP
          END

```

CP/M implements a named file structure on each disk, providing a logical organization that allows any particular file to contain any number of records from completely empty to the full capacity of the drive. Each drive is logically distinct with a disk directory and file data area. The disk file names are in three parts: the drive select code, the filename consisting of one to eight nonblank characters, and the filetype consisting of zero to three nonblank characters. The filetype names the generic category of a particular file, while the filename distinguishes individual files in each category. The filetypes listed below name a few generic categories that have been established, although they are somewhat arbitrary.

ASM	Assembler Source	PLI	PL/I Source File
PRN	Printer Listing	REL	Relocatable Module
HEX	Hex Machine Code	TEX	TEX Formatter Source
BAS	Basic Source File	BAK	ED Source Backup
INT	Intermediate Code	SYM	SID Symbol File
COM	Command File	\$\$\$	Temporary File

Source files are treated as a sequence of ASCII characters, where each "line" of the source file is followed by a carriage-return line-feed sequence (0DH followed by 0AH). Thus one 128-byte CP/M record could contain several lines of source text. The end of an ASCII file is denoted by a control-Z character (1AH) or a real end-of-file returned by the CP/M read operation. Control-Z characters embedded within machine code files (e.g., COM files) are ignored, however, and the end-of-file condition returned by CP/M is used to terminate read operations.

Files in CP/M can be thought of as a sequence of up to 65536 records of 128 bytes each, numbered from 0 through 65535, thus allowing a maximum of 8 megabytes per file. However, the user should note that although the records may be considered logically contiguous, they may not be physically contiguous in the disk data area. Internally, all files are divided into 16K byte segments called logical extents, so that counters are easily maintained as 8-bit values. The division into extents is discussed in the paragraphs that follow; however, they are not particularly significant for the programmer, since each extent is automatically accessed in both sequential and random access modes.

In the file operations starting with function number 15, DE usually addresses a file control block (FCB). Transient programs often use the default file control block area reserved by CP/M at location BOOT+005CH (normally 005CH) for simple file operations. The basic unit of file information is a 128-byte record used for all file operations; thus, a default location for disk I/O is provided by CP/M at location BOOT+0080H (normally 0080H), which is the initial default DMA address (see function 26). All directory operations take place in a reserved area that does not affect write buffers as was the case in release 1, with the exception of Search First and Search Next, where compatibility is required.

The FCB data area consists of a sequence of 33 bytes for sequential access and a series of 36 bytes in the case when the file is accessed randomly. The default FCB normally located at 005CH can be used for random access files, since the three bytes starting at BOOT+007DH are available for this purpose. The FCB format is shown with the following fields:

dr	f1	f2	/	/f8	t1	t2	t3	ex	s1	s2	rc	d0	/	/dn	cr	r0	r1	r2
00	01	02	...	08	09	10	11	12	13	14	15	16	...	31	32	33	34	35

where

dr	drive code (0-16) 0 => use default drive for file 1 => auto disk select drive A, 2 => auto disk select drive B, ... 16=> auto disk select drive P.
f1...f8	contain the file name in ASCII upper case, with high bit = 0
t1,t2,t3	contain the file type in ASCII upper case, with high bit = 0 t1', t2', and t3' denote the bit of these positions, t1' = 1 => Read/Only file, t2' = 1 => SYS file, no DIR list
ex	contains the current extent number, normally set to 00 by the user, but in range 0-31 during file I/O
s1	reserved for internal system use
s2	reserved for internal system use, set to zero on call to OPEN, MAKE, SEARCH
rc	record count for extent "ex," takes on values from 0-127
d0...dn	filled-in by CP/M, reserved for system use
cr	current record to read or write in a sequential file operation, normally set to zero by user
r0,r1,r2	optional random record number in the range 0-65535, with overflow to r2, r0, r1 constitute a 16-bit value with low byte r0, and high byte r1

Each file being accessed through CP/M must have a corresponding FCB, which provides the name and allocation information for all subsequent file operations. When accessing files, it is the programmer's responsibility to fill the lower 16 bytes of the FCB and initialize the cr field. Normally, bytes 1 through 11 are set to the ASCII character values for the file name and file type, while all other fields are zero.

FCBs are stored in a directory area of the disk, and are brought into central memory before the programmer proceeds with file operations (see the OPEN and MAKE functions). The memory copy of the FCB is updated as file operations take place and later recorded permanently on disk at the termination of the file operation (see the CLOSE command).

The CCP constructs the first 16 bytes of two optional FCBs for a transient by scanning the remainder of the line following the transient name, denoted by file1 and file2 in the prototype command line described above, with unspecified fields set to ASCII blanks. The first FCB is constructed at location BOOT+005CH and can be used as is for subsequent file operations. The second FCB occupies the d0 ... dn portion of the first FCB and must be moved to another area of memory before use. If, for example, the operator types

```
PROGRAMME B:X.ZOT Y.ZAP
```

the file PROGRAM.COM is loaded into the TPA and the default FCB at BOOT+005CH is initialized to drive code 2, file name X, and file type ZOT. The second drive code takes the default value 0, which is placed at BOOT+006CH, with the file name Y placed into location BOOT+006DH and file type ZAP located 8 bytes later at BOOT+0075H. All remaining fields through cr are set to zero. The user should note again that it is the programmer's responsibility to move this second file name and type to another area, usually a separate file control block, before opening the file that begins at BOOT+005CH, because the open operation will overwrite the second name and type.

If no file names are specified in the original command, the fields beginning at BOOT+005DH and BOOT+006DH contain blanks. In all cases, the CCP translates lower case alphabets to upper case to be consistent with the CP/M file naming conventions.

As an added convenience, the default buffer area at location BOOT+0080H is initialized to the command line tail typed by the operator following the program name. The first position contains the number of characters, with the characters themselves following the character count. Given the above command line, the area beginning at BOOT+0080H is initialized as follows:

BOOT+0080H:

```
+00 +01 +02 +03 +04 +05 +06 +07 +08 +09 +A +B +C +D +E  
E  ' ' 'B' ':' 'X' ':' 'Z' 'O' 'T' ' ' 'Y' ':' 'Z' 'A' 'P'
```

where the characters are translated to upper case ASCII with uninitialized memory following the last valid character. Again, it is the responsibility of the programmer to extract the information from this buffer before any file operations are performed, unless the default DMA address is explicitly changed.

Individual functions are described in detail in the pages that follow.

#### Function 0: System Reset

Entry Parameters:

Register C: 00H

The system reset function returns control to the CP/M operating system at the CCP level. The CCP reinitializes the disk subsystem by selecting and logging in disk drive A. This function has exactly the same effect as a jump to location BOOT.

#### Function 1: Console Input

Entry Parameters:

Register C: 01H

Returned Value:

Register A: ASCII Character

The console input function reads the next console character to register A. Graphic characters, along with carriage return, line feed, and back space (ctl-H) are echoed to the

console. Tab characters (ctl-I) move the cursor to the next tab stop. A check is made for start/stop scroll (ctl-S) and start/stop printer echo (ctl-P). The FDOS does not return to the calling program until a character has been typed, thus suspending execution if a character is not ready.

#### **Function 2: Console Output**

Entry Parameters:

Register C: 02H

Register E: ASCII Character

The ASCII character from register E is sent to the console device. As in function 1, tabs are expanded and checks are made for start/stop scroll and printer echo.

#### **Function 3: Reader Input**

Entry Parameters:

Register C: 03H

Returned Value:

Register A: ASCII Character

The Reader Input function reads the next character from the logical reader into register A (see the IOBYTE definition in Chapter 6). Control does not return until the character has been read.

#### **Function 4: Punch Output**

Entry Parameters:

Register C: 04H

Register E: ASCII Character

The Punch Output function sends the character from register E to the logical punch device.

#### **Function 5: List Output**

Entry Parameters:

Register C: 05H

Register E: ASCII Character

The List Output function sends the ASCII character in register E to the logical listing device.

#### **Function 6: Direct Console I/O**

**Entry Parameters:**

Register C: 06H  
Register E: 0FFH (input) or  
char (output)

**Returned Value:**

Register A: char or status

Direct console I/O is supported under CP/M for those specialized applications where basic console input and output are required. Use of this function should, in general, be avoided since it bypasses all of CP/M's normal control character functions (e.g., control-S and control-P). Programs that perform direct I/O through the BIOS under previous releases of CP/M, however, should be changed to use direct I/O under BDOS so that they can be fully supported under future releases of MP/M and CP/M.

Upon entry to function 6, register E either contains hexadecimal FF, denoting a console input request, or an ASCII character. If the input value is FF, function 6 returns A = 00 if no character is ready, otherwise A contains the next console input character.

If the input value in E is not FF, function 6 assumes that E contains a valid ASCII character that is sent to the console.

Function 6 must not be used in conjunction with other console I/O functions.

#### **Function 7: Get I/O Byte**

**Entry Parameters:**

Register C: 07H

**Returned Value:**

Register A: I/O Byte Value

The Get I/O Byte function returns the current value of IOBYTE in register A. See Chapter 6 for IOBYTE definition.

#### **Function 8: Set I/O Byte**

**Entry Parameters:**

Register C: 08H  
Register E: I/O Byte Value

The Set I/O Byte function changes the IOBYTE value to that given in register E.



### Function 9: Print String

#### Entry Parameters:

Register C: 09H  
Registers DE: String Address

The Print String function sends the character string stored in memory at the location given by DE to the console device, until a \$ is encountered in the string. Tabs are expanded as in function 2, and checks are made for start/stop scroll and printer echo.

### Function 10: Read Console Buffer

#### Entry Parameters:

Register C: 0AH  
Registers DE: Buffer Address

#### Returned Value:

Console Characters in Buffer

The Read Buffer function reads a line of edited console input into a buffer addressed by registers DE. Console input is terminated when either input buffer overflows or a carriage return or line feed is typed. The Read Buffer takes the form:

DE: +0	+1	+2	+3	+4	+5	+6	+7	+8	...	+n
mx	nc	c1	c2	c3	c4	c5	c6	c7	...	??

where mx is the maximum number of characters that the buffer will hold (1 to 255) and nc is the number of characters read (set by FDOS upon return), followed by the characters read from the console. If nc < mx, then uninitialized positions follow the last character, denoted by ?? in the above figure. A number of control functions are recognized during line editing:

rub/del	removes and echoes the last character
ctl-C	reboots when at the beginning of line
ctl-E	causes physical end of line
ctl-H	backspaces one character position
ctl-J	(line feed) terminates input line
ctl-M	(return) terminates input line
ctl-R	retypes the current line after new line
ctl-U	removes current line
ctl-X	same as ctl-U.

The user should also note that certain functions that return the carriage to the leftmost position (e.g., ctl-X) do so only to the column position where the prompt ended (in earlier

releases, the carriage returned to the extreme left margin). This convention makes operator data input and line correction more legible.

**Function 11: Get Console Status**

Entry Parameters:

Register C: 0BH

Returned Value:

Register A: Console Status

The Console Status function checks to see if a character has been typed at the console. If a character is ready, the value 0FFH is returned in register A. Otherwise a 00H value is returned.

**Function 12: Return Version Number**

Entry Parameters:

Register C: 0CH

Returned Value:

Registers HL: Version Number

Function 12 provides information that allows version independent programming. A two-byte value is returned, with H = 00 designating the CP/M release (H = 01 for MP/M), and L = 00 for all releases previous to 2.0. CP/M 2.0 returns a hexadecimal 20 in register L, with subsequent version 2 releases in the hexadecimal range 21, 22, through 2F. Using function 12, for example, the user can write application programs that provide both sequential and random access functions.

**Function 13: Reset Disk System**

Entry Parameters:

Register C: 0DH

The Reset Disk Function is used to programmatically restore the file system to a reset state where all disks are set to read/write (see functions 28 and 29), only disk drive A is selected, and the default DMA address is reset to BOOT+0080H. This function can be used, for example, by an application program that requires a disk change without a system reboot.

#### Function 14: Select Disk

Entry Parameters:

Register C: 0EH  
Register E: Selected Disk

The Select Disk function designates the disk drive named in register E as the default disk for subsequent file operations, with E = 0 for drive A, 1 for drive B, and so on through 15, corresponding to drive P in a full 16 drive system. The drive is placed in an on-line status, which activates its directory until the next cold start, warm start, or disk system reset operation. If the disk medium is changed while it is on-line, the drive automatically goes to a read/only status in a standard CP/M environment (see function 28). FCBs that specify drive code zero (dr = 00H) automatically reference the currently selected default drive. Drive code values between 1 and 16, however, ignore the selected default drive and directly reference drives A through P.

#### Function 15: Open File

Entry Parameters:

Register C: 0FH  
Registers DE: FCB Address

Returned Value:

Register A: Directory Code

The Open File operation is used to activate a file that currently exists in the disk directory for the currently active user number. The FDOS scans the referenced disk directory for a match in positions 1 through 14 of the FCB referenced by DE (byte s1 is automatically zeroed), where an ASCII question mark (3FH) matches any directory character in any of these positions. Normally, no question marks are included, and bytes ex and s2 of the FCB are zero.

If a directory element is matched, the relevant directory information is copied into bytes d0 through dn of the FCB, thus allowing access to the files through subsequent read and write operations. The user should note that an existing file must not be accessed until a successful open operation is completed. Upon return, the open function returns a directory code with the value 0 through 3 if the open was successful or 0FFH (255 decimal) if the file cannot be found. If question marks occur in the FCB, the first matching FCB is activated. Note that the current record (cr) must be zeroed by the program if the file is to be accessed sequentially from the first record.

#### Function 16: Close File

##### Entry Parameters:

Register C: 10H  
Registers DE: FCB Address

##### Returned Value:

Register A: Directory Code

The Close File function performs the inverse of the open file function. Given that the FCB addressed by DE has been previously activated through an open or make function (see functions 15 and 22), the close function permanently records the new FCB in the referenced disk directory. The FCB matching process for the close is identical to the open function. The directory code returned for a successful close operation is 0, 1, 2, or 3, while a 0FFH (255 decimal) is returned if the file name cannot be found in the directory. A file need not be closed if only read operations have taken place. If write operations have occurred, however, the close operation is necessary to record the new directory information permanently.

#### Function 17: Search for First

##### Entry Parameters

Register C: 11H  
Registers DE: FCB Address

##### Returned Value:

Register A: Directory Code

Search First scans the directory for a match with the file given by the FCB addressed by DE. The value 255 (hexadecimal FF) is returned if the file is not found; otherwise, 0, 1, 2, or 3 is returned indicating the file is present. When the file is found, the current DMA address is filled with the record containing the directory entry, and the relative starting position is  $A * 32$  (i.e., rotate the A register left 5 bits, or ADD A five times). Although not normally required for application programs, the directory information can be extracted from the buffer at this position.

An ASCII question mark (63 decimal, 3F hexadecimal) in any position from f1 through ex matches the corresponding field of any directory entry on the default or auto-selected disk drive. If the dr field contains an ASCII question mark, the auto disk select function is disabled and the default disk is searched, with the search function returning any matched entry, allocated or free, belonging to any user number. This latter function is not normally used by application programs, but it allows complete flexibility to scan all current directory values. If the dr field is not a question mark, the s2 byte is automatically zeroed.

**Function 18: Search for Next**

## Entry Parameters:

Register C: 12H

## Returned Value:

Register A: Directory Code

The Search Next function is similar to the Search First function, except that the directory scan continues from the last matched entry. Similar to function 17, function 18 returns the decimal value 255 in A when no more directory items match.

**Function 19: Delete File**

## Entry Parameters:

Register C: 13H

Registers DE: FCB Address

## Returned Value:

Register A: Directory Code

The Delete File function removes files that match the FCB addressed by DE. The filename and type may contain ambiguous references (i.e., question marks in various positions), but the drive select code cannot be ambiguous, as in the Search and Search Next functions.

Function 19 returns a decimal 255 if the referenced file or files cannot be found; otherwise, a value in the range 0 to 3 is returned.

**Function 20: Read Sequential**

## Entry Parameters:

Register C: 14H

Registers DE: FCB Address

## Returned Value:

Register A: Directory Code

Given that the FCB addressed by DE has been activated through an open or make function (numbers 15 and 22), the Read Sequential function reads the next 128-byte record from the file into memory at the current DMA address. The record is read from position cr of the extent, and the cr field is automatically incremented to the next record position. If the cr field overflows, the next logical extent is automatically opened and the cr field is reset to zero in preparation for the next read operation. The value 00H is returned in the A register if the read operation was successful, while a nonzero value is returned if no data exist at the next record position (e.g., end-of-file occurs).

### **Function 21: Write Sequential**

**Entry Parameters:**

Register C: 15H  
Registers DE: FCB Address

**Returned Value:**

Register A: Directory Code

Given that the FCB addressed by DE has been activated through an open or make function (numbers 15 and 22), the Write Sequential function writes the 128-byte data record at the current DMA address to the file named by the FCB. The record is placed at position cr of the file, and the cr field is automatically incremented to the next record position. If the cr field overflows, the next logical extent is automatically opened and the cr field is reset to zero in preparation for the next write operation. Write operations can take place into an existing file, in which case, newly written records overlay those that already exist in the file. Register A = 00H upon return from a successful write operation, while a nonzero value indicates an unsuccessful write caused by a full disk.

### **Function 22: Make File**

**Entry Parameters:**

Register C: 16H  
Registers DE: FCB Address

**Returned Value:**

Register A: Directory Code

The Make File operation is similar to the open file operation except that the FCB must name a file that does not exist in the currently referenced disk directory (i.e., the one named explicitly by a nonzero dr code or the default disk if dr is zero). The FDOS creates the file and initializes both the directory and main memory value to an empty file. The programmer must ensure that no duplicate file names occur, and a preceding delete operation is sufficient if there is any possibility of duplication. Upon return, register A = 0, 1, 2, or 3 if the operation was successful and 0FFH (255 decimal) if no more directory space is available. The make function has the side effect of activating the FCB and thus a subsequent open is not necessary.

### **Function 23: Rename File**

**Entry Parameters:**

Register C: 17H  
Registers DE: FCB Address

**Returned Value:**

Register A: Directory Code

The Rename function uses the FCB addressed by DE to change all occurrences of the file named in the first 16 bytes to the file named in the second 16 bytes. The drive code dr

at position 0 is used to select the drive, while the drive code for the new file name at position 16 of the FCB is assumed to be zero. Upon return, register A is set to a value between 0 and 3 if the rename was successful and 0FFH (255 decimal) if the first file name could not be found in the directory scan.

#### **Function 24: Return Log-in Vector**

**Entry Parameters:**

Register C: 18H

**Returned Value:**

Registers HL: Log-in Vector

The log-in vector value returned by CP/M is a 16-bit value in HL, where the least significant bit of L corresponds to the first drive A and the high order bit of H corresponds to the sixteenth drive, labeled P. A 0 bit indicates that the drive is not on-line, while a 1 bit marks a drive that is actively on-line as a result of an explicit disk drive selection or an implicit drive select caused by a file operation that specified a nonzero dr field. The user should note that compatibility is maintained with earlier releases, since registers A and L contain the same values upon return.

#### **Function 25: Return Current Disk**

**Entry Parameters:**

Register C: 19H

**Returned Value:**

Register A: Current Disk

Function 25 returns the currently selected default disk number in register A. The disk numbers range from 0 through 15 corresponding to drives A through P.

#### **Function 26: Set DMA Address**

**Entry Parameters:**

Register C: 1AH

Registers DE: DMA Address

DMA is an acronym for Direct Memory Address, which is often used in connection with disk controllers that directly access the memory of the mainframe computer to transfer data to and from the disk subsystem. Although many computer systems use non-DMA access (i.e., the data are transferred through programmed I/O operations), the DMA address has, in CP/M, come to mean the address at which the 128-byte data record resides before a disk write and after a disk read. Upon cold start, warm start, or disk

system reset, the DMA address is automatically set to BOOT+0080H. The Set DMA function, however, can be used to change this default value to address another area of memory where the data records reside. Thus, the DMA address becomes the value specified by DE until it is changed by a subsequent Set DMA function, cold start, warm start, or disk system reset.

**Function 27: Get ADDR(Alloc)**

Entry Parameters:

Register C: 1BH

Returned Value:

Registers HL: ALLOC Address

An allocation vector is maintained in main memory for each on-line disk drive. Various system programs use the information provided by the allocation vector to determine the amount of remaining storage (see the STAT program). Function 27 returns the base address of the allocation vector for the currently selected disk drive. However, the allocation information may be invalid if the selected disk has been marked read/only. Although this function is not normally used by application programs, additional details of the allocation vector are found in Chapter 6.

**Function 28: Write Protect Disk**

Entry Parameters:

Register C: 1CH

The disk write protect function provides temporary write protection for the currently selected disk. Any attempt to write to the disk before the next cold or warm start operation produces the message:

BDOS ERR on d: R/O

**Function 29: Get Read/Only Vector**

Entry Parameters:

Register C: 1DH

Returned Value:

Registers HL: R/O Vector Value

Function 29 returns a bit vector in register pair HL, which indicates drives that have the temporary read-only bit set. As in function 24, the least significant bit corresponds to drive A, while the most significant bit corresponds to drive P. The R/O bit is set either by an explicit call to function 28 or by the automatic software mechanisms within CP/M that detect changed disks.



### **Function 30: Set File Attributes**

#### Entry Parameters:

Register C: 1EH  
Registers DE: FCB Address

#### Returned Value:

Register A: Directory Code

The Set File Attributes function allows programmatic manipulation of permanent indicators attached to files. In particular, the R/O and System attributes (t1' and t2') can be set or reset. The DE pair addresses an unambiguous file name with the appropriate attributes set or reset. Function 30 searches for a match and changes the matched directory entry to contain the selected indicators. Indicators f1' through f4' are not currently used, but may be useful for applications programs, since they are not involved in the matching process during file open and close operations. Indicators f5' through f8' and t3' are reserved for future system expansion.

### **Function 31: Get ADDR(Disk Parms)**

#### Entry Parameters:

Register C: 1FH

#### Returned Value:

Registers HL: DPB Address

The address of the BIOS resident disk parameter block is returned in HL as a result of this function call. This address can be used for either of two purposes. First, the disk parameter values can be extracted for display and space computation purposes, or transient programs can dynamically change the values of current disk parameters when the disk environment changes, if required. Normally, application programs will not require this facility.

### **Function 32: Set/Get User Code**

#### Entry Parameters:

Register C: 20H  
Register E: 0FFH (get) or  
User Code (set)

#### Returned Value:

Register A: Current Code or  
(no value)

An application program can change or interrogate the currently active user number by calling function 32. If register E = 0FFH, the value of the current user number is

returned in register A, where the value is in the range of 0 to 15. If register E is not OFFH, the current user number is changed to the value of E (modulo 16).

### Function 33: Read Random

#### Entry Parameters:

Register C: 21H  
Registers DE: FCB Address

#### Returned Value:

Register A: Return Code

The Read Random function is similar to the sequential file read operation of previous releases, except that the read operation takes place at a particular record number, selected by the 24-bit value constructed from the 3-byte field following the FCB (byte positions r0 at 33, r1 at 34, and r2 at 35). The user should note that the sequence of 24 bits is stored with least significant byte first (r0), middle byte next (r1), and high byte last (r2). CP/M does not reference byte r2, except in computing the size of a file (function 35). Byte r2 must be zero, however, since a nonzero value indicates overflow past the end of file.

Thus, the r0, r1 byte pair is treated as a double-byte, or "word" value, which contains the record to read. This value ranges from 0 to 65535, providing access to any particular record of the 8-megabyte file. To process a file using random access, the base extent (extent 0) must first be opened. Although the base extent may or may not contain any allocated data, this ensures that the file is properly recorded in the directory and is visible in DIR requests. The selected record number is then stored in the random record field (r0, r1), and the BDOS is called to read the record. Upon return from the call, register A either contains an error code, as listed below, or the value 00, indicating the operation was successful. In the latter case, the current DMA address contains the randomly accessed record. The user should note that contrary to the sequential read operation, the record number is not advanced. Thus, subsequent random read operations continue to read the same record.

Upon each random read operation, the logical extent and current record values are automatically set. Thus, the file can be sequentially read or written, starting from the current randomly accessed position. However, the user should note that, in this case, the last randomly read record will be reread as one switches from random mode to sequential read and the last record will be rewritten as one switches to a sequential write operation. The user can, of course, simply advance the random record position following each random read or write to obtain the effect of a sequential I/O operation.

Error codes returned in register A following a random read are listed below.

01	reading unwritten data
02	(not returned in random mode)
03	cannot close current extent
04	seek to unwritten extent
05	(not returned in read mode)
06	seek past physical end of disk

Error codes 01 and 04 occur when a random read operation accesses a data block that has not been previously written or an extent that has not been created, which are equivalent conditions. Error code 03 does not normally occur under proper system

operation. If it does, it can be cleared by simply rereading or reopening extent zero as long as the disk is not physically write protected. Error code 06 occurs whenever byte r2 is nonzero under the current 2.0 release. Normally, nonzero return codes can be treated as missing data, with zero return codes indicating operation complete.

<b>Function 34: Write Random</b>	
Entry Parameters:	
Register C:	22H
Registers DE:	FCB Address
Returned Value:	
Register A:	Return Code

The Write Random operation is initiated similarly to the Read Random call, except that data are written to the disk from the current DMA address. Further, if the disk extent or data block that is the target of the write has not yet been allocated, the allocation is performed before the write operation continues. As in the Read Random operation, the random record number is not changed as a result of the write. The logical extent number and current record positions of the file control block are set to correspond to the random record that is being written. Again, sequential read or write operations can begin following a random write, with the notation that the currently addressed record is either read or rewritten again as the sequential operation begins. The user can also simply advance the random record position following each write to get the effect of a sequential write operation. The user should note that, in particular, reading or writing the last record of an extent in random mode does not cause an automatic extent switch as it does in sequential mode.

The error codes returned by a random write are identical to the random read operation with the addition of error code 05, which indicates that a new extent cannot be created as a result of directory overflow.

<b>Function 35: Compute File Size</b>	
Entry Parameters:	
Register C:	23H
Registers DE:	FCB Address
Returned Value:	
Random Record Field Set	

When computing the size of a file, the DE register pair addresses an FCB in random mode format (bytes r0, r1, and r2 are present). The FCB contains an unambiguous file name that is used in the directory scan. Upon return, the random record bytes contain the "virtual" file size, which is, in effect, the record address of the record following the end of the file. Following a call to function 35, if the high record byte r2 is 01, the file contains the maximum record count 65536. Otherwise, bytes r0 and r1 constitute a 16-bit value (r0 is the least significant byte, as before), which is the file size.

Data can be appended to the end of an existing file by simply calling function 35 to set the random record position to the end of file and then performing a sequence of random writes starting at the preset record address.

The virtual size of a file corresponds to the physical size when the file is written sequentially. If the file was created in random mode and "holes" exist in the allocation, the file may in fact contain fewer records than the size indicates. For example, if only the last record of an 8-megabyte file is written in random mode (i.e., record number 65535), the virtual size is 65536 records, although only one block of data is actually allocated.

#### **Function 36: Set Random Record**

**Entry Parameters:**

Register C: 24H

Registers DE: FCB Address

**Returned Value:**

Random Record Field Set

The Set Random Record function causes the BDOS automatically to produce the random record position from a file that has been read or written sequentially to a particular point. The function can be useful in two ways.

First, it is often necessary initially to read and scan a sequential file to extract the positions of various "key" fields. As each key is encountered, function 36 is called to compute the random record position for the data corresponding to this key. If the data unit size is 128 bytes, the resulting record position is placed into a table with the key for later retrieval. After scanning the entire file and tabulating the keys and their record numbers, the user can move instantly to a particular keyed record by performing a random read, using the corresponding random record number that was saved earlier. The scheme is easily generalized for variable record lengths, since the program need only store the buffer-relative byte position along with the key and record number to find the exact starting position of the keyed data at a later time.

A second use of function 36 occurs when switching from a sequential read or write over to random read or write. A file is sequentially accessed to a particular point in the file, function 36 is called, which sets the record number, and subsequent random read and write operations continue from the selected point in the file.

#### **Function 37: Reset Drive**

**Entry Parameters:**

Register C: 25H

Registers DE: Drive Vector

**Returned Value:**

Register A: 00H

The Reset Drive function allows resetting of specified drives. The passed parameter is a 16 bit vector of drives to be reset; the least significant bit is drive A.

To maintain compatibility with MP/M, CP/M returns a zero value.

#### Function 40: Write Random With Zero Fill

##### Entry Parameters:

Register C: 28H  
Registers DE: FCB Address

##### Returned Value:

Register A: Return Code

The Write Random With Zero Fill operation is similar to Function 34, with the exception that a previously unallocated block is filled with zeros before the data are written.

### 5.3 A Sample File-to-File Copy Program

The program shown below provides a relatively simple example of file operations. The program source file is created as COPY.ASM using the CP/M ED program and then assembled using ASM or MAC, resulting in a HEX file. The LOAD program is used to produce a COPY.COM file, which executes directly under the CCP. The program begins by setting the stack pointer to a local area and proceeds to move the second name from the default area at 006CH to a 33-byte file control block called DFCB. The DFCB is then prepared for file operations by clearing the current record field. At this point, the source and destination FCBs are ready for processing, since the SFCB at 005CH is properly set up by the CCP upon entry to the COPY program. That is, the first name is placed into the default FCB, with the proper fields zeroed, including the current record field at 007CH. The program continues by opening the source file, deleting any existing destination file, and creating the destination file. If all this is successful, the program loops at the label COPY until each record has been read from the source file and placed into the destination file. Upon completion of the data transfer, the destination file is closed and the program returns to the CCP command level by jumping to BOOT.

```

;
; sample file-to-file copy program
;
; at the ccp level, the command
;
; copy a:x.y b:u.v
;
; copies the file named x.y from drive
; a to a file named u.v. on drive b.
;
0000 = boot equ 0000h ; system reboot
0005 = bdos equ 0005h ; bdos entry point
005c = fcbl equ 005ch ; first file name
005c = sfcbl equ fcbl ; source fcb
006c = fcb2 equ 006ch ; second file name
0080 = dbuff equ 0080h ; default buffer
0100 = tpa equ 0100h ; beginning of tpa
;
0009 = printf equ 9 ; print buffer func#
000f = openf equ 15 ; open file func#
0010 = closef equ 16 ; close file func#
```

```

0013 =          deletef equ 19      ; delete file func#
0014 =          readf   equ 20      ; sequential read
0015 =          writef  equ 21      ; sequential write
0016 =          makef   equ 22      ; make file func#
;
0100           org tpa      ; beginning of tpa
0100 311b02    lxi  sp,stack ; local stack
;
;
;          move second file name to dfcb
0103 0e10     mvi  c,16      ; half an fcb
0105 116c00    lxi  d,fc2     ; source of move
0108 21da01    lxi  h,dfcb    ; destination fcb
010b 1a        mfcfb:  ldax d      ; source fcb
010c 13        inx  d      ; ready next
010d 77        mov  m,a    ; dest fcb
010e 23        inx  h      ; ready next
010f 0d        dcr  c      ; count 16...0
0110 c20b01    jnz  mfcfb   ; loop 16 times
;
;          name has been removed, zero cr
0113 af       xra  a      ; a = 00h
0114 32fa01    sta  dfcbcr  ; current rec = 0
;
;          source and destination fcb's ready
;
0117 115c00    lxi  d,sfcb    ; source file
011a cd6901    call open     ; error if 255
011d 118701    lxi  d,nofile  ; ready message
0120 3c        inr  a      ; 255 becomes 0
0121 cc6101    cz   finis    ; done if no file
;
;          source file open, prep destination
0124 11da01    lxi  d,dfcb    ; destination
0127 cd7301    call delete   ; remove if present
;
;          source file open, dest file open
;          copy until end of file on source
;
0137 115c00    copy:  lxi  d,sfcb    ; source
013a cd7801    call read     ; read next record
013d b7        ora  a      ; end of file?
013e c25101    jnz  eofile   ; skip write if so
;
;          not end of file, write the record
0141 11da01    lxi  d,dfcb    ; destination
0144 cd7d01    call write    ; write record
0147 11a901    lxi  d,space   ; ready message
014a b7        ora  a      ; 00 if write ok
014b c46101    cnz  finis    ; end if so

```

```

014e c33701          jmp copy      ; loop until eof
                    ;
                    eofile: ; end of file, close destination
0151 11da01          lxi d,dfcb   ; destination
0154 cd6e01          call close   ; 255 if error
0157 21bb01          lxi h,wrprot ; ready message
015a 3c              inr a        ; 255 becomes 00
015b cc6101          cz finis     ; shouldn't happen
                    ;
                    ; copy operation complete, end
015e 11cc01          lxi d,normal ; ready message
                    ;
                    finis:  ; write message given by de, reboot
0161 0e09           mvi c,printf
0163 cd0500          call bdos    ; write message
0166 c30000          jmp boot     ; reboot system
                    ;
                    ; system interface subroutines
                    ; (all return directly from bdos)
                    ;
0169 0e0f           open:  mvi c,openf
016b c30500          jmp bdos
                    ;
016e 0e10           close: mvi c,closef
0170 c30500          jmp bdos
                    ;
0173 0e13           delete mvi c,deletef
0175 c30500          jmp bdos
                    ;
0178 0e14           read:  mvi c,readf
017a c30500          jmp bdos
                    ;
017d 0e15           write: mvi c,writef
017f c30500          jmp bdos
                    ;
0182 0e16           make:  mvi c,makef
0184 c30500          jmp bdos
                    ;
                    ; console messages
0187 6e6f20f        nofile: db 'no source file$'
0196 6e6f209        nodir:  db 'no directory space$'
01a9 6f7574f        space: db 'out of data space$'
01bb 7772695        wrprot: db 'write protected?$'
01cc 636f700        normal: db 'copy complete$'
                    ;
                    ; data areas
01da              dfcb:  ds 33      ; destination fcb
01fa =            dfcbr  equ dfcb+32 ; current record
                    ;
01fb              ds 32      ; 16 level stack
                    stack:
021b              end

```

The user should note that there are several simplifications in this particular program. First, there are no checks for invalid file names that could, for example, contain ambiguous references. This situation could be detected by scanning the 32-byte default area starting at location 005CH for ASCII question marks. A check should also be made to ensure that the file names have, in fact, been included (check locations 005DH and 006DH for nonblank ASCII characters). Finally, a check should be made to ensure that the source and destination file names are different. An improvement in speed could be obtained by buffering more data on each read operation. One could, for example, determine the size of memory by fetching FBASE from location 0006H and using the entire remaining portion of memory for a data buffer. In this case, the programmer simply resets the DMA address to the next successive 128-byte area before each read. Upon writing to the destination file, the DMA address is reset to the beginning of the buffer and incremented by 128 bytes to the end as each record is transferred to the destination file.

## 5.4 A Sample File Dump Utility

The file dump program shown below is slightly more complex than the simple copy program given in the previous section. The dump program reads an input file, specified in the CCP command line, and displays the content of each record in hexadecimal format at the console. Note that the dump program saves the CCP's stack upon entry, resets the stack to a local area, and restores the CCP's stack before returning directly to the CCP. Thus, the dump program does not perform a warm start at the end of processing.

```

                                ; DUMP program reads input file and displays hex
                                data
                                ;
0100                                org 100h
0005 =                             bdos  equ 0005h = ;bdos entry point
0001 =                             cons  equ 1      ;read console
0002 =                             typef equ 2      ;type function
0009 =                             printf equ 9      ;buffer print entry
000b =                             brkf  equ 11     ;break key function
                                ;(true if char
000f =                             openf equ 15     ;file open
0014 =                             readf equ 20     ;read function
                                ;
005c =                             fcb   equ 5ch    ;file control block
                                ;address
0080 =                             buff  equ 80h    ;input disk buffer
                                ;address
                                ;
                                ; non graphic characters
000d =                             cr   equ 0dh    ;carriage return
000a =                             lf   equ 0ah    ;line feed
                                ;
                                ; file control block definitions
005c =                             fcbdn equ fcb+0  ;disk name
005d =                             fcbfn equ fcb+1  ;file name
0065 =                             fcbft equ fcb+9  ;disk file type (3
                                ;characters)
0068 =                             fcbrl equ fcb+12 ;file's current reel
                                ;number
006b =                             fcbrc equ fcb+15 ;file's record count (0 to
                                ;128)128)
007c =                             fcbcr equ fcb+32 ;current (next) record
                                ;number (0

```



```

007d =          fcbln    equ fcb+33    ;fcb length
;
;          set up stack
0100 210000    lxi  h,0
0103 39        dad  sp
;          entry stack pointer in hl from the ccp
0104 221502    shld oldsp
;          set sp to local stack area (restored at
;          finis)
0107 315702    lxi  sp,stktop
;          read and print successive buffers
010a cdc101    call setup    ;set up input file
010d feff      cpi  255      ;255 if file not present
010f c21b01    jnz  openok    ;skip if open is ok
;
;          file not there, give error message and
;          return
0112 11f301    lxi  d,opnmsg
0115 cd9c01    call  err
0118 c35101    jmp  finis      ;to return
;
openok:        ;open operation ok, set buffer index to
;end
011b 3e80      mvi  a,80h
011d 321302    sta  ibp      ;set buffer pointer to 80h
;          hl contains next address to print
0120 210000    lxi  h,0      ;start with 0000
;
gloop:
0123 e5        pushh      ;save line position
0124 cda201    call  gnb
0127 e1        pop  h      ;recall line position
0138 da5101    jc   finis    ;carry set by gnb if end
;          ;file
012b 47        mov  b,a
;          print hex values
;          check for line fold
012c 7d        mov  a,l
012d e60f      ani  0fh      ;check low 4 bits
012f c24401    jnz  nonum
;          print line number
0132 cd7201    call  crlf
;
;          check for break key
0135 cd5901    call  break
;          accum lsb = 1 if character ready
0138 0f        rrc      ;into carry
0139 da5101    jc   finis    ;don't print any more
;
013c 7c        mov  a,h
013d cd8f01    call  phex
0140 7d        mov  a,l
0141 cd8f01    call  phex
;          nonum:
0144 23        inx  h      ;to next line number

```

```

0145 3e20          mvi a,' '
0147 cd6501       call pchar
014a 78           mov a,b
014b cd8f01       call phex
014e c32301       jmp gloop
;
; finis:
;           end of dump, return to cco
;           (note that a jmp to 0000h reboots)
0151 cd7201       call crlf
0154 2a1502       lhld oldsp
0157 f9           sphl
;           stack pointer contains ccp's stack
;           location
0158 c9           ret          ;to the ccp
;
;
;           subroutines
;
break:           ;check break key (actually any key will
;do)
0159 e5d5c5       push h! push d! push b; environment
;saved
015c 0e0b         mvi c,brkf
015e cd0500       call bdos
0161 c1d1e1       pop b! pop d! pop h; environment
restored
0164 c9           ret
;
; pchar:      ;print a character
0165 e5d5c5       push h! push d! push b; saved
0168 0e02         mvi c,typef
016a 5f           mov e,a
016b cd0500       call bdos
016e c1d1e1       pop b! pop d! pop h; restored
0171 c9           ret
;
; crlf:
0172 3e0d         mvi a,cr
0174 cd6501       call pchar
0177 3e0a         mvi a,lf
0179 cd6501       call pchar
017c c9           ret
;
;
; pnib:      ;print nibble in reg a
017d e60f         ani 0fh          ;low 4 bits
017f fe0a         cpi 10
0181 d28901       jnc p10
;           less than or equal to 9
0184 c630         adi '0'
0186 c38b01       jmp prn
;
;
;           greater or equal to 10
0189 c637         p10:          adi 'a' - 10

```

```

018b cd6501      prn:      call  pchar
018e c9          ret
;
;phex:          ;print hex char in reg a
018f f5          pushpsw
0190 0f          rrc
0191 0f          rrc
0192 0f          rrc
0193 0f          rrc
0194 cd7d01      call  pnib      ;print nibble
0197 f1          pop  psw
0198 cd7d01      call  pnib
019b c9          ret
;
;err:          ;print error message
;              d,e addresses message ending with "$"
019c 0e09        mvi  c,printf   ;print buffer
;              ;function
019e cd0500      call  bdos
01a1 c9          ret
;
;
;gnb:          ;get next byte
01a2 3a1302      lda  ibp
01a5 fe80        cpi  80h
01a7 c2b301      jnz  g0
;              read another buffer
;
;
01aa cdce01      call  diskr
01ad b7          ora  a          ;zero value if read ok
01ae cab301      jz   g0        ;for another byte
;              end of data, return with carry set for eof
01b1 37          stc
01b2 c9          ret
;
;g0:          ;read the byte at buff+reg a
01b3 5f          mov  e,a        ;ls byte of buffer index
01b4 1600        mvi  d,0        ;double precision
;              ;index to de
01b6 3c          inr  a          ;index=index+1
01b7 321302      sta  ibp        ;back to memory
;              pointer is incremented
;              save the current file address
01ba 218000      lxi  h,buff
01bd 19          dad  d
;              absolute character address is in hl
01be 7e          mov  a,m
;              byte is in the accumulator
01bf b7          ora  a          ;reset carry bit
01c0 c9          ret
;
;setup:        ;set up file
;              open the file for input
01c1 af          xra  a          ;zero to accum

```

```

01c2 327c00          sta  fcbcr      ;clear current record
                    ;
01c5 115c00          lxi  d,fcb
01c8 0e0f            mvi  c,openf
01ca cd0500          call bdos
                    ;
                    255 in accum if open error
01cd c9              ret
                    ;
                    disk: ;read disk file record
01ce e5d5c5          push h! push d! push b
01d1 115c00          lxi  d,fcb
01d4 0e14            mvi  c,readf
01d6 cd0500          call bdos
01d9 c1d1e1          pop b! pop d! pop h
01dc c9              ret
                    ;
                    ;
                    fixed message area
01dd 46494c0         signon: db 'file dump version 2.0$'
01f3 0d0a4e0         opnmsg: db cr,lf,'no input file present on
                    disk$'
                    ;
                    ;
                    variable area
0213                ibp:   ds  2      ;input buffer pointer
0215                oldsp: ds  2      ;entry sp value from ccp
                    ;
                    ;
                    stack area
0217                ds  64      ;reserve 32 level stack
                    stktop:
                    ;
0257                end

```

## 5.5 A Sample Random Access Program

This chapter concludes with an extensive example of random access operation. The program listed below performs the simple function of reading or writing random records upon command from the terminal. Given that the program has been created, assembled, and placed into a file labeled RANDOM.COM, the CCP level command

```
RANDOM X.DAT
```

starts the test program. The program looks for a file by the name X.DAT (in this particular case) and, if found, proceeds to prompt the console for input. If not found, the file is created before the prompt is given. Each prompt takes the form

```
next command?
```

and is followed by operator input, terminated by a carriage return. The input commands take the form

```
nW nR Q
```

where n is an integer value in the range 0 to 65535, and W, R, and Q are simple command characters corresponding to random write, random read, and quit processing, respectively. If the W command is issued, the RANDOM program issues the prompt

type data:

The operator then responds by typing up to 127 characters, followed by a carriage return. RANDOM then writes the character string into the X.DAT file at record n. If the R command is issued, RANDOM reads record number n and displays the string value at the console. If the Q command is issued, the X.DAT file is closed, and the program returns to the CCP. In the interest of brevity, the only error message is

error, try again.

The program begins with an initialization section where the input file is opened or created, followed by a continuous loop at the label "ready" where the individual commands are interpreted. The default file control block at 005CH and the default buffer at 0080H are used in all disk operations. The utility subroutines then follow, which contain the principal input line processor, called "readc." This particular program shows the elements of random access processing, and can be used as the basis for further program development.

### Sample Random Access Program for CP/M 2.0

```
0100          org      100h      ;base of tpa
;
0000 =        reboot  equ      0000h  ;system reboot
0005 =        bdos    equ      0005h  ;bdos entry point
;
0001 =        coninp  equ      1      ;console input function
0002 =        conout  equ      2      ;console output function
0009 =        pstring equ      9      ;print string until '$'
000a =        rstring equ      10     ;read console buffer
000c =        version equ      12     ;return version number
000f =        openf   equ      15     ;file open function
0010 =        closef  equ      16     ;close function
0016 =        makef   equ      22     ;make file function
0021 =        readr   equ      33     ;read random
0022 =        writer  equ      34     ;write random
;
005c =        fcb     equ      005ch  ;default file control
;block
007d =        ranrec  equ      fcb+33  ;random record position
007f =        ranovf  equ      fcb+35  ;high order (overflow)
;byte
0080 =        buff    equ      0080h  ;buffer address
;
000d =        cr      equ      0dh    ;carriage return
000a =        lf      equ      0ah    ;line feed
;
```

### Load SP, Set-Up File for Random Access

```
0100 31bc00          lxi      sp,stack
;
;
0103 0e0c          mvi      c,version
```

```

0105 cd0500      call    bdos
0108 fe20        cpi     20h      ;version 2.0 or better?
010a d21600      jnc     versok
;
010d 111b00      ; bad version, message and go back
0110 cdda00      lxi     d,badver
0113 c30000      call    print
;
; versok:
;
0116 0e0f        mvi     c,openf  ;open default fcb
0118 115c00      lxi     d,fcbl
011b cd0500      call    bdos
011e 3c          inr     a        ;err 255 becomes zero
011f c23700      jnz     ready
;
;
0122 0e16        mvi     c,makef
0124 115c00      lxi     d,fcbl
0127 cd0500      call    bdos
012a 3c          inr     a        ;err 255 becomes zero
012b c23700      jnz     ready
;
;
012e 113a00      lxi     d,nospace
0131 cdda00      call    print
0134 c30000      jmp     reboot   ;back to ccp

```

### Loop Back to Ready After Each Command

```

;
ready:
; file is ready for processing
;
0137 cde500      call    readcom  ;read next command
013a 227d00      shld   ranrec   ;store input record#
013d 217f00      lxi     h,ranovf
0140 3600        mvi     m,0     ;clear high byte if set
0142 fe51        cpi     'Q'     ;quit?
0144 c25600      jnz     notq
;
;
0147 0e10        mvi     c,closef
0149 115c00      lxi     d,fcbl
014c cd0500      call    bdos
014f 3c          inr     a        ;err 255 becomes 0
0150 cab900      jz     error   ;error message, retry
0153 c30000      jmp     reboot   ;back to ccp
;

```

### End of Quit Command, Process Write

```
notq:
; not the quit command, random write?
0156 fe57 cpi 'W'
0158 c28900 jnz notw
;
; this is a random write, fill buffer until cr
015b 114d00 lxi d,datmsg
015e cdda00 call print ;data prompt
0161 0e7f mvi c,127 ;up to 127 characters
0163 218000 lxi h,buff ;destination
rloop: ;read next character to buff
0166 c5 push b ;save counter
0167 e5 push h ;next destination
0168 cdc200 call getch ;character to a
016b e1 pop h ;restore counter
016c c1 pop b ;restore next to fill
016d fe0d cpi cr ;end of line?
016f ca7800 jz erloop
; not end, store character
0172 77 mov m,a
0173 23 inx h ;next to fill
0174 0d dcr c ;counter goes down
0175 c26600 jnz rloop ;end of buffer?
erloop:
; end of read loop, store 00
0178 3600 mvi m,0
;
; write the record to selected record number
017a 0e22 mvi c,writer
017c 115c00 lxi d,fcbl
017f cd0500 call bdos
0182 b7 ora a ;error code zero?
0183 c2b900 jnz error ;message if not
0186 c33700 jmp ready ;for another record
;
```

### End of Write Command, Process Read

```
notw:
; not a write command, read record?
0189 fe52 cpi 'R'
018b c2b900 jnz error ;skip if not
;
; read random record
018e 0e21 mvi c,readr
0190 115c00 lxi d,fcbl
0193 cd0500 call bdos
0196 b7 ora a ;return code 00?
0197 c2b900 jnz error
;
; read was successful, write to console
```

```

019a cdcf00      call    crlf      ;new line
019d 0e80      mvi     c,128    ;max 128 characters
019f 218000    lxi     h,buff   ;next to get

wloop:
01a2 7e       mov     a,m      ;next character
01a3 23       inx     h        ;next to get
01a4 e67f     ani     7fh      ;mask parity
01a6 ca3700    jz      ready   ;for another command
                                ;if 00
01a9 c5       push    b        ;save counter
01aa e5       push    h        ;save next to get
01ab fe20     cpi     ' '      ;graphic?
01ad d4c800    cnc     putchar  ;skip output if not
01b0 e1       pop     h
01b1 c1       pop     b
01b2 0d      dcr     c        ;count=count-1
01b3 c2a200   jnz     wloop
01b6 c33700   jmp     ready

```

#### End of Read Command, All Errors End Up Here

```

;
error:
01b9 115900   lxi     d,errmsg
01bc cdda00   call    print
01bf c33700   jmp     ready
;

```

#### Utility Subroutines for Console I/O

```

getchr:
                                ;read next console character to a
01c2 0e01     mvi     c,coninp
01c4 cd0500   call    bdos
01c7 c9       ret

;
putchr:
                                ;write character from a to console
01c8 0e02     mvi     c,conout
01ca 5f       mov     e,a      ;character to send
01cb cd0500   call    bdos     ;send character
01ce c9       ret

;
crlf:
                                ;send carriage return line feed
01cf 3e0d     mvi     a,cr     ;carriage return
01d1 cdc800   call    putchar
01d4 3e0a     mvi     a,lf     ;line feed
01d6 cdc800   call    putchar
01d9 c9       ret

```



```

;
print:
;print the buffer addressed by de until $
01da d5      push    d
01db cdcf00  call    crlf
01de d1      pop     d      ;new line
01df 0e09    mvi    c,pstring
01e1 cd0500  call    bdos   ;print the string
01e4 c9      ret

;
readcom:
;read the next command line to the conbuf
01e5 116b00  lxi    d,prompt
01e8 cdda00  call    print  ;command?
01eb 0e0a    mvi    c,rstring
01ed 117a00  lxi    d,conbuf
01f0 cd0500  call    bdos   ;read command line
;
command line is present, scan it
01f3 210000  lxi    h,0     ;start with 0000
01f6 117c00  lxi    d,conlin ;command line
01f9 1a      readc: ldax   d      ;next command
;character
01fa 13      inx    d      ;to next command
;position
01fb b7      ora    a      ;cannot be end of
;command
01fc c8      rz
;
not zero, numeric?
01fd d630    sui    '0'
01ff fe0a    cpi    10     ;carry if numeric
0201 d21300  jnc    endrd
;
add-in next digit
0204 29      dad    h      ;*2
0205 4d      mov    c,l
0206 44      mov    b,h    ;bc = value * 2
0207 29      dad    h      ;*4
0208 29      dad    h      ;*8
0209 09      dad    b      ;*2 + *8 = *10
020a 85      add    l      ;+digit
020b 6f      mov    l,a
020c d2f900  jnc    readc  ;for another char
020f 24      inr    h      ;overflow
0210 c3f900  jmp    readc  ;for another char
endrd:
;
end of read, restore value in a
0213 c630    adi    '0'    ;command
0215 fe61    cpi    'a'    ;translate case?
0217 d8      rc
;
lower case, mask lower case bits
0218 e65f    ani    101$1111b
021a c9      ret
;

```

### String Data Area for Console Messages

021b 536f79	badver:	db	'sorry, you need cp/m version 2\$'
023a 4e6f29	nospace:	db	'no directory space\$'
024d 547970	datmsg:	db	'type data: \$'
0259 457272	errmsg:	db	'error, try again.\$'
026b 4e6570	prompt:	db	'next command? \$'
			;

### Fixed and Variable Data Area

027a 21	conbuf:	db	conlen	;length of console buffer
027b	consiz:	ds	1	;resulting size after read
027c	conlin:	ds	32	;length 32 buffer
0021 =	conlen	equ	\$-consiz	
				;
029c		ds	32	;16 level stack
02bc	stack:			end

Again, major improvements could be made to this particular program to enhance its operation. In fact, with some work, this program could evolve into a simple data base management system. One could, for example, assume a standard record size of 128 bytes, consisting of arbitrary fields within the record. A program, called GETKEY, could be developed that first reads a sequential file and extracts a specific field defined by the operator. For example, the command

```
GETKEY NAMES.DAT LASTNAME 10 20
```

would cause GETKEY to read the data base file NAMES.DAT and extract the "LAST-NAME" field from each record, starting in position 10 and ending at character 20. GETKEY builds a table in memory consisting of each particular LASTNAME field, along with its 16-bit record number location within the file. The GETKEY program then sorts this list and writes a new file, called LASTNAME.KEY, which is an alphabetical list of LASTNAME fields with their corresponding record numbers. (This list is called an *inverted index* in information retrieval parlance.)

If the programmer were to rename the program shown above as QUERY and massage it so that it reads a sorted key file into memory, the command line might appear as

```
QUERY NAMES.DAT LASTNAME.KEY.
```

Instead of reading a number, the QUERY program reads an alphanumeric string that is a particular key to find in the NAMES.DAT data base. Since the LASTNAME.KEY list is sorted, one can find a particular entry rapidly by performing a "binary search," similar to looking up a name in the telephone book. That is, starting at both ends of the list, one examines the entry halfway in between and, if not matched, splits either the upper half or

the lower half for the next search. The user will quickly reach the item he or she is looking for and find the corresponding record number. The user should fetch and display this record at the console, just as was done in the program shown above.

With some more work, the user can allow a fixed grouping size that differs from the 128-byte record shown above. This is accomplished by keeping track of the record number as well as the byte offset within the record. Knowing the group size, one randomly accesses the record containing the proper group, offset to the beginning of the group within the record read sequentially until the group size has been exhausted.

Finally, one can improve QUERY considerably by allowing boolean expressions, which compute the set of records that satisfy several relationships, such as a LASTNAME between HARDY and LAUREL and an AGE lower than 45. Display all the records that fit this description. Finally, if the user's lists are getting too big to fit into memory, he or she should randomly access key files from the disk as well.

## 5.6 System Function Summary

FUNCTION NUMBER		FUNCTION NAME	INPUT	OUTPUT
Decimal	Hex			
0	0	System Reset	C = 00H	none
1	1	Console Input	C = 01H	A = ASCII char
2	2	Console Output	E = char	none
3	3	Reader Input		A = ASCII char
4	4	Punch Output	E = char	none
5	5	List Output	E = char	none
6	6	Direct Console I/O	C = 06H E = OFFH (input) or OFEH (status) or char (output)	A = char or status (no value)
7	7	Get I/O Byte	none	A = I/O Byte Value
8	8	Set I/O Byte	E = I/O Byte	none
9	9	Print String	DE = Buffer Address	none
10	A	Read Console Buffer	DE = Buffer	Console Characters in Buffer
11	B	Get Console Status	none	A = 00/non zero
12	C	Return Version Number	none	HL: Version Number
13	D	Reset Disk System	none	none
14	E	Select Disk	E = Disk Number	none
15	F	Open File	DE = FCB Address	FF if not found
16	10	Close File	DE = FCB Address	FF if not found

17	11	Search For First	DE = FCB Address	A = Directory Code
18	12	Search For Next	none	A = Directory Code
19	13	Delete File	DE = FCB Address	A = none
20	14	Read Sequential	DE = FCB Address	A = Error Code
21	15	Write Sequential	DE = FCB Address	A = Error Code
22	16	Make File	DE = FCB Address	A = FF if no DIR Space
23	17	Rename File	DE = FCB Address	A = FF if not found
24	18	Return Login Vector	none	HL = Login Vector*
25	19	Return Current Disk	none	A = Current Disk Number
26	1A	Set DMA Address	DE = DMA Address	none
27	1B	Get ADDR (ALLOC)	none	HL = ALLOC Address*
28	1C	Write Protect Disk	none	none
29	1D	Get Read/only Vector	none	HL = R/O Vector Value*
30	1E	Set File Attributes	DE = FCB Address	A = none
31	1F	Get ADDR (Disk Parms)	none	HL = DPB Address
32	20	Set/Get User Code	E = 0FFH for Get E = 00 to 0FH for Set	User Number
33	21	Read Random	DE = FCB Address	A = Error Code
34	22	Write Random	DE = FCB Address	A = Error Code
35	23	Compute File Size	DE = FCB Address	r0, r1, r2
36	24	Set Random Record	DE = FCB Address	r0, r1, r2
37	25	Reset Drive	DE = Drive Vector	A = 0
38	26	Access Drive	not supported	
39	27	Free Drive	not supported	
40	28	Write Random with Fill	DE = FCB	A = Error Code

\*Note that A = L, and B = H upon return.



# 6

## CP/M 2 Alteration

### 6.1 Introduction

The standard CP/M system assumes operation on an Intel MDS-800 microcomputer development system, but is designed so the user can alter a specific set of subroutines that define the hardware operating environment.

Although standard CP/M 2 is configured for single density floppy disks, field-alteration features allow adaptation to a wide variety of disk subsystems from single drive minidisks through high-capacity, "hard disk" systems. To simplify the following adaptation process, it is assumed that CP/M 2 will first be configured for single density floppy disks where minimal editing and debugging tools are available. If an earlier version of CP/M is available, the customizing process is eased considerably. In this latter case, the user may wish to review the system generation process and skip to later sections that discuss system alteration for nonstandard disk systems.

To achieve device independence, CP/M is separated into three distinct modules:

BIOS	basic I/O system, which is environment dependent
BDOS	basic disk operating system, which is not dependent upon the hardware configuration
CCP	the console command processor, which uses the BDOS

Of these modules, only the BIOS is dependent upon the particular hardware. That is, the user can "patch" the distribution version of CP/M to provide a new BIOS that provides a customized interface between the remaining CP/M modules and the user's own hardware system. This document provides a step-by-step procedure for patching a new BIOS into CP/M.

All disk-dependent portions of CP/M 2 are placed into a BIOS, a resident "disk parameter block," which is either hand coded or produced automatically using the disk definition macro library provided with CP/M 2. The end user need only specify the maximum number of active disks, the starting and ending sector numbers, the data allocation size, the maximum extent of the logical disk, directory size information, and reserved track values. The macros use this information to generate the appropriate tables and table references for use during CP/M 2 operation. Deblocking information is provided, which

aids in assembly or disassembly of sector sizes that are multiples of the fundamental 128 byte data unit, and the system alteration manual includes general purpose subroutines that use the deblocking information to take advantage of larger sector sizes. Use of these subroutines, together with the table-drive data access algorithms, makes CP/M 2 a universal data management system.

File expansion is achieved by providing up to 512 logical file extents, where each logical extent contains 16K bytes of data. CP/M 2 is structured, however, so that as much as 128K bytes of data are addressed by a single physical extent (corresponding to a single directory entry) maintaining compatibility with previous versions while taking advantage of directory space.

If CP/M is being tailored to a computer system for the first time, the new BIOS requires some simple software development and testing. The standard BIOS is listed in Appendix A and can be used as a model for the customized package. A skeletal version of the BIOS given in Appendix B can serve as the basis for a modified BIOS. In addition to the BIOS, the user must write a simple memory loader, called GETSYS, that brings the operating system into memory. To patch the new BIOS into CP/M, the user must write the reverse of GETSYS, called PUTSYS, which places an altered version of CP/M back onto the diskette. PUTSYS can be derived from GETSYS by changing the disk read commands into disk write commands. Sample skeletal GETSYS and PUTSYS programs are described in Section 6.4 and listed in Appendix C. To make the CP/M system load automatically, the user must also supply a cold start loader, similar to the one provided with CP/M (listed in Appendices A and D). A skeletal form of a cold start loader is given in Appendix E, which serves as a model for the loader.

## 6.2 First Level System Regeneration

The procedure to patch the CP/M system is given below. Address references in each step are shown with "H" denoting the hexadecimal radix, and are given for a 20K CP/M system. For larger CP/M systems, a "bias" is added to each address that is shown with a "+b" following it, where b is equal to the memory size—20K. Values for b in various standard memory sizes are

24K:	$b = 24K - 20K = 4K = 1000H$
32K:	$b = 32K - 20K = 12K = 3000H$
40K:	$b = 40K - 20K = 20K = 5000H$
48K:	$b = 48K - 20K = 28K = 7000H$
56K:	$b = 56K - 20K = 36K = 9000H$
62K:	$b = 62K - 20K = 42K = A800H$
64K:	$b = 64K - 20K = 44K = B000H$

It should be noted that the standard distribution version of CP/M is set for operation within a 20K memory system. Therefore, the user must first bring up the 20K CP/M system, then configure it for actual memory size (the user should see Section 6.3).

The user should:

1. Read Section 6.4 and write a GETSYS program that reads the first two tracks of a diskette into memory. The program from the diskette must be loaded starting at location 3380H. GETSYS is coded to start at location 100H (base of the TPA), as shown in Appendix C.

2. Test the GETSYS program by reading a blank diskette into memory and check to see that the data have been read properly and that the diskette has not been altered in any way by the GETSYS program.

3. Run the GETSYS program using an initialized CP/M diskette to see if GETSYS loads CP/M starting at 3380H (the operating system actually starts 128 bytes later at 3400H).

4. Read Section 6.4 and write the PUTSYS program. This writes memory starting at 3380H back onto the first two tracks of the diskette. The PUTSYS program should be located at 200H, as shown in Appendix C.

5. Test the PUTSYS program using a blank, uninitialized diskette by writing a portion of memory to the first two tracks; clear memory and read it back using GETSYS. Test PUTSYS completely, since this program will be used to alter CP/M on disk.

6. Study Sections 6.5, 6.6, and 6.7 along with the distribution version of the BIOS given in Appendix A and write a simple version that performs a similar function for the customized environment. Use the program given in Appendix B as a model. Call this new BIOS by the name CBIOS (customized BIOS). Implement only the primitive disk operations on a single drive and simple console input/output functions in this phase.

7. Test CBIOS completely to ensure that it properly performs console character I/O and disk reads and writes. Be careful to ensure that no disk write operations occur during read operations and check that the proper track and sectors are addressed on all reads and writes. Failure to make these checks may cause destruction of the initialized CP/M system after it is patched.

8. Referring to the table in Section 6.5, note that the BIOS is placed between locations 4A00H and 4FFFH. Read the CP/M system using GETSYS and replace the BIOS segment by the CBIOS developed in step 6 and tested in step 7. This replacement is done in memory.

9. Use PUTSYS to place the patched memory image of CP/M onto the first two tracks of a blank diskette for testing.

10. Use GETSYS to bring the copied memory image from the test diskette back into memory at 3380H and check to ensure that it has loaded back properly (clear memory, if possible, before the load). Upon successful load, branch to the cold start code at location 4A00H. The cold start routine will initialize page zero, then jump to the CCP at location 3400H, which will call the BDOS, which will call the CBIOS. The CBIOS will be asked by the CCP to read sixteen sectors on track 2, and CP/M will type "A>", the system prompt.

If difficulties are encountered, use whatever debug facilities are available to trace and breakpoint the CBIOS.

11. Upon completion of step 10, CP/M has prompted the console for a command input. Test the disk write operation by typing

SAVE 1 X.COM



(All commands must be followed by a carriage return.) CP/M responds with another prompt (after several disk accesses)

A>

If it does not, debug the disk write functions and retry.

12. Test the directory command by typing

DIR

CP/M responds with

A: X COM

13. Test the erase command by typing

ERA X.COM

CP/M responds with the A prompt. This is now an operational system that only requires a bootstrap loader to function completely.

14. Write a bootstrap loader that is similar to GETSYS and place it on track 0, sector 1 using PUTSYS (again using the test diskette, not the distribution diskette). See Sections 6.5 and 6.8 for more information on the bootstrap operation.

15. Retest the new test diskette with the bootstrap loader installed by executing steps 11, 12, and 13. Upon completion of these tests, type a control-C (control and C keys simultaneously). The system executes a "warm start" that reboots the system, and types the A prompt.

16. At this point, there is probably a good version of the customized CP/M system on the test diskette. Use GETSYS to load CP/M from the test diskette. Remove the test diskette, place the distribution diskette (or a legal copy) into the drive, and use PUTSYS to replace the distribution version with the customized version. The user should not make this replacement if unsure of the patch because this step destroys the system that was obtained from Digital Research.

17. Load the modified CP/M system and test it by typing

DIR

CP/M responds with a list of files that are provided on the initialized diskette. One file is the memory image for the debugger

DDT.COM

Note that from now on, it is important always to reboot the CP/M system (ctl-C is sufficient) when the diskette is removed and replaced by another diskette, unless the new diskette is to be read only.

18. Load and test the debugger by typing

DDT

(See Chapter 4 for operating procedures.)

19. Before making further CBIOS modifications, practice using the editor (see Chapter 2), and assembler (see Chapter 3). Recode and test the GETSYS, PUTSYS, and CBIOS programs using ED, ASM, and DDT. Code and test a COPY program that does a sector-to-sector copy from one diskette to another to obtain back-up copies of the original diskette. (Read the CP/M Licensing Agreement specifying legal responsibilities when copying the CP/M system.) Place the copyright notice

Copyright ©, 1979  
Digital Research

on each copy that is made with the COPY program.

20. Modify the CBIOS to include the extra functions for punches, readers, and sign-on messages, and add the facilities for additional disk drives, if desired. These changes can be made with the GETSYS and PUTSYS programs or by referring to the regeneration process in Section 6.3.

The user should now have a good copy of the customized CP/M system. Although the CBIOS portion of CP/M belongs to the user, the modified version cannot be legally copied for anyone else's use.

It should be noted that the system remains file-compatible with all other CP/M systems (assuming media compatibility), which allows transfer of nonproprietary software between CP/M users.

## 6.3 Second Level System Generation

Once the system is running, the user will want to configure CP/M for the desired memory size. Usually a memory image is first produced with the "MOVCPM" program (system relocater) and then placed into a named disk file. The disk file can then be loaded, examined, patched, and replaced using the debugger and the system generation program. (The user should refer to Chapter 1.)

The CBIOS and BOOT are modified using ED and assembled using ASM, producing files called CBIOS.HEX and BOOT.HEX, which contain the code for CBIOS and BOOT in Intel hex format.

To get the memory image of CP/M into the TPA configured for the desired memory size, the user should type the command

```
MOVCPM xx *
```

where xx is the memory size in decimal K bytes (e.g., 32 for 32K). The response will be

```
CONSTRUCTING xxK CP/M VERS 2.0  
READY FOR "SYSGEN" OR  
"SAVE 34 CPMxx.COM"
```

An image of CP/M in the TPA is configured for the requested memory size. The memory image is at location 0900H through 227FH (i.e., the BOOT is at 0900H, the CCP is at 980H, the BDOS starts at 1180H, and the BIOS is at 1F80H). The user should note that the memory image has the standard MDS-800 BIOS and BOOT on it. It is now necessary to save the memory image in a file so that the user can patch the CBIOS and CBOOT into it:

```
SAVE 34 CPMxx.COM
```

The memory image created by the "MOVCPM" program is offset by a negative bias so that it loads into the free area of the TPA, and thus does not interfere with the operation of CP/M in higher memory. This memory image can be subsequently loaded under DDT and examined or changed in preparation for a new generation of the system. DDT is loaded with the memory image by typing:

```
DDT CPMxx.COM      Load DDT, then read the CPM image.
```

DDT should respond with

```
NEXT PC
2300 0100
-                (The DDT prompt)
```

The user can then give the display and disassembly commands to examine portions of the memory image between 900H and 227FH. The user should note, however, that to find any particular address within the memory image, one must apply the negative bias to the CP/M address to find the actual address. Track 00, sector 01, is loaded to location 900H (the user should find the cold start loader at 900H to 97FH); track 00, sector 02, is loaded into 980H (this is the base of the CCP); and so on through the entire CP/M system load. In a 20K system, for example, the CCP resides at the CP/M address 3400H, but is placed into memory at 980H by the SYSGEN program. Thus, the negative bias, denoted by *n*, satisfies

$$3400H + n = 980H, \text{ or } n = 980H - 3400H$$

Assuming that twos complement arithmetic,  $n = -D580H$ , which can be checked by

$$3400H + D580H = 10980H = 0980H \text{ (ignoring high-order overflow).}$$

Note that for larger systems, *n* satisfies

$$\begin{aligned} (3400H+b) + n &= 980H, \text{ or} \\ n &= 980H - (3400H + b), \text{ or} \\ n &= D580H - b \end{aligned}$$

The value of *n* for common CP/M systems is given below.

Memory Size	Bias <i>b</i>	Negative Offset <i>n</i>
20K	0000H	D580H - 0000H = D580H
24K	1000H	D580H - 1000H = C580H
32K	3000H	D580H - 3000H = A580H
40K	5000H	D580H - 5000H = 8580H
48K	7000H	D580H - 7000H = 6580H
56K	9000H	D580H - 9000H = 4580H
62K	A800H	D580H - A800H = 2D80H
64K	B000H	D580H - B000H = 2580H

If the user wants to locate the address *x* within the memory image loaded under DDT in a 20K system, first type

```
Hx,n          Hexadecimal sum and difference
```

and DDT will respond with the value of  $x+n$  (sum) and  $x-n$  (difference). The first number printed by DDT is the actual memory address in the image where the data or code are located. The DDT command

H3400,D580

for example, will produce 980H as the sum, which is where the CCP is located in the memory image under DDT.

The user should type the L command to disassemble portions of the BIOS located at  $(4A00H+b)-n$ , which, when one uses the H command, produces an actual address of 1F80H. The disassembly command would thus be

L1F80

It is now necessary to patch in the CBOOT and CBIOS routines. The BOOT resides at location 0900H in the memory image. If the actual load address is "n", then to calculate the bias (m), the user types the command

H900,n                      Subtract load address from target address.

The second number typed by DDT in response to the command is the desired bias (m). For example, if the BOOT executes at 0080H, the command

H900,80

will produce

0980 0880                      Sum and difference in hex.

Therefore, the bias "m" would be 0880H. To read-in the BOOT, the user should give the command

ICBOOT.HEX                      Input file CBOOT.HEX.

Then

Rm                              Read CBOOT with a bias of m (=900H-n).

The user may now examine the CBOOT with

L900

The user is now ready to replace the CBIOS by examining the area at 1F80H where the original version of the CBIOS resides and then typing

ICBIOS.HEX                      Ready the hex file for loading.

The user assumes that the CBIOS is being integrated into a 20K CP/M system and thus originates at location 4A00H. To locate the CBIOS properly in the memory image under DDT, one must apply the negative bias n for a 20K system when loading the hex file. This is accomplished by typing

RD580                              Read the file with bias D580H.

Upon completion of the read, the user should reexamine the area where the CBIOS has been loaded (use an "L1F80" command) to ensure that it was loaded properly. When satisfied that the change has been made, the user should return from DDT using a control-C or, "Go" command.

SYSGEN is used to replace the patched memory image back onto a diskette (the user should utilize a test diskette until sure of the patch), as shown in the following interaction:

SYSGEN	Start the SYSGEN program
SYSGEN VERSION 2.0	Sign-on message from SYSGEN
SOURCE DRIVE NAME (OR RETURN TO SKIP)	Respond with a carriage return to skip the CP/M read operation since the system is already in memory
DESTINATION DRIVE NAME (OR RETURN TO REBOOT)	Respond with "B" to write the new system to the diskette in drive B
DESTINATION ON B, THEN TYPE RETURN	Place a scratch diskette in drive B, then type return.
FUNCTION COMPLETE DESTINATION DRIVE NAME (OR RETURN TO REBOOT)	

The user should place the scratch diskette in drive A and then perform a cold start to bring up the newly configured CP/M system.

The new CP/M system is then tested and the Digital Research copyright notice is placed on the diskette, as specified in the Licensing Agreement:

Copyright ©, 1979  
Digital Research

## 6.4 Sample GETSYS and PUTSYS Programs

The following program provides a framework for the GETSYS and PUTSYS programs referenced in Sections 6.1 and 6.2. The READSEC and WRITESEC subroutines must be inserted by the user to read and write the specific sectors.

```

; GETSYS PROGRAM — READ TRACKS 0 AND 1 TO MEMORY AT 3380H
; REGISTER USE
;
; A (SCRATCH REGISTER)
; B TRACK COUNT (0, 1)
; C SECTOR COUNT (1,2, . . .,26)
; DE (SCRATCH REGISTER PAIR)
; HL LOAD ADDRESS
; SP SET TO STACK ADDRESS
;
START: LXI SP,3380H ;SET STACK POINTER TO SCRATCH
;AREA
LXI H, 3380H ;SET BASE LOAD ADDRESS
MVI B, 0 ;START WITH TRACK 0

```

```

RDTRK:                                ;READ NEXT TRACK (INITIALLY 0)
      MVI C,1                          ;READ STARTING WITH SECTOR 1

RDSEC:                                ;READ NEXT SECTOR
      CALL READSEC                      ;USER-SUPPLIED SUBROUTINE
      LXI D,128                        ;MOVE LOAD ADDRESS TO NEXT 1/2
      ;PAGE
      DAD D                            ;HL = HL + 128
      INR C                            ;SECTOR = SECTOR + 1
      MOV A,C                          ;CHECK FOR END OF TRACK
      CPI 27
      JC RDSEC                          ;CARRY GENERATED IF SECTOR < 27

;
; ARRIVE HERE AT END OF TRACK, MOVE TO NEXT TRACK
      INR B
      MOV A,B                          ;TEST FOR LAST TRACK
      CPI 2
      JC RDTRK                          ;CARRY GENERATED IF TRACK < 2

;
; ARRIVE HERE AT END OF LOAD, HALT FOR NOW
      HLT

;
; USER-SUPPLIED SUBROUTINE TO READ THE DISK
READSEC:
; ENTER WITH TRACK NUMBER IN REGISTER B,
; SECTOR NUMBER IN REGISTER C, AND
; ADDRESS TO FILL IN HL
;
      PUSH B                            ;SAVE B AND C REGISTERS
      PUSH H                            ;SAVE HL REGISTERS
      .....
      perform disk read at this point, branch to
      label START if an error occurs
      .....
      POP H                            ;RECOVER HL
      POP B                            ;RECOVER B AND C REGISTERS
      RET                              ;BACK TO MAIN PROGRAM

      END START

```

This program is assembled and listed in Appendix B for reference purposes, with an assumed origin of 100H. The hexadecimal operation codes that are listed on the left may be useful if the program has to be entered through the panel switches.

The PUTSYS program can be constructed from GETSYS by changing only a few operations in the GETSYS program given above, as shown in Appendix C. The register pair HL becomes the dump address (next address to write), and operations upon these registers do not change within the program. The READSEC subroutine is replaced by a WRITESEC subroutine, which performs the opposite function: data from address HL are written to the track given by register B and sector given by register C. It is often useful to combine GETSYS and PUTSYS into a single program during the test and development phase, as shown in Appendix C.

## 6.5 Diskette Organization

The sector allocation for the standard distribution version of CP/M is given here for reference purposes. The first sector (see the table on the following page) contains an optional software boot section. Disk controllers are often set up to bring track 0, sector 1, into memory at a specific location (often location 0000H). The program in this sector, called BOOT, has the responsibility of bringing the remaining sectors into memory starting at location 3400H+b. If the user's controller does not have a built-in sector load, the program in track 0, sector 1 can be ignored. In this case, load the program from track 0, sector 2, to location 3400H+b.

As an example, the Intel MDS-800 hardware cold start loader brings track 0, sector 1, into absolute address 3000H. Upon loading this sector, control transfers to location 3000H, where the bootstrap operation commences by loading the remainder of track 0 and all of track 1 into memory, starting at 3400H+b. The user should note that this bootstrap loader is of little use in a non-MDS environment, although it is useful to examine it since some of the boot actions will have to be duplicated in the user's cold start loader.

Track#	Sector#	Page#	Memory Address (boot address)	CP/M Module name
00	01			Cold Start Loader
00	02	00	3400H+b	CCP
'	03	'	3480H+b	'
'	04	01	3500H+b	'
'	05	'	3580H+b	'
'	06	02	3600H+b	'
'	07	'	3680H+b	'
'	08	03	3700H+b	'
'	09	'	3780H+b	'
'	10	04	3800H+b	'
'	11	'	3880H+b	'
'	12	05	3900H+b	'
'	13	'	3980H+b	'
'	14	06	3A00H+b	'
'	15	'	3A80H+b	'
'	16	07	3B00H+b	'
00	17	'	3B80H+b	CCP
00	18	08	3C00H+b	BDOS
'	19	'	3C80H+b	'
'	20	09	3D00H+b	'
'	21	'	3D80H+b	'
'	22	10	3E00H+b	'
'	23	'	3E80H+b	'
'	24	11	3F00H+b	'
'	25	'	3F80H+b	'
'	26	12	4000H+b	'
01	01	'	4080H+b	'
'	02	13	4100H+b	'
'	03	'	4180H+b	'
'	04	14	4200H+b	'
'	05	'	4280H+b	'
'	06	15	4300H+b	'
'	07	'	4380H+b	'
'	08	16	4400H+b	'
'	09	'	4480H+b	'

'	10	17	4500H+b	'
'	11	'	4580H+b	'
'	12	18	4600H+b	'
'	13	'	4680H+b	'
'	14	19	4700H+b	'
'	15	'	4780H+b	'
'	16	20	4800H+b	'
'	17	'	4880H+b	'
'	18	21	4900H+b	'
01	19	'	4980H+b	BDOS
07	20	22	4A00H+b	BIOS
'	21	'	4A80H+b	'
'	22	23	4B00H+b	'
'	23	'	4B80H+b	'
'	24	24	4C00H+b	'
01	25	'	4C80H+b	BIOS
01	26	25	4D00H+b	BIOS
02-76	01-26			(directory and data)

## 6.6 The BIOS Entry Points

The entry points into the BIOS from the cold start loader and BDOS are detailed below. Entry to the BIOS is through a "jump vector" located at 4A00H+b, as shown below (see Appendices A and B, as well). The jump vector is a sequence of 17 jump instructions that send program control to the individual BIOS subroutines. The BIOS subroutines may be empty for certain functions (i.e., they may contain a single RET operation) during reconfiguration of CP/M, but the entries must be present in the jump vector.

The jump vector at 4A00H+b takes the form shown below, where the individual jump addresses are given to the left:

4A00H+b	JMP BOOT	; ARRIVE HERE FROM COLD START LOAD
4A03H+b	JMP WBOOT	; ARRIVE HERE FOR WARM START
4A06H+b	JMP CONST	; CHECK FOR CONSOLE CHAR READY
4A09H+b	JMP CONIN	; READ CONSOLE CHARACTER IN
4A0CH+b	JMP CONOUT	; WRITE CONSOLE CHARACTER OUT
4A0FH+b	JMP LIST	; WRITE LISTING CHARACTER OUT
4A12H+b	JMP PUNCH	; WRITE CHARACTER TO PUNCH DEVICE
4A15H+b	JMP READER	; READ READER DEVICE
4A18H+b	JMP HOME	; MOVE TO TRACK 00 ON SELECTED DISK
4A1BH+b	JMP SELDSK	; SELECT DISK DRIVE
4A1EH+b	JMP SETTRK	; SET TRACK NUMBER
4A21H+b	JMP SETSEC	; SET SECTOR NUMBER



4A24H+b	JMP SETDMA	; SET DMA ADDRESS
4A27H+b	JMP READ	; READ SELECTED SECTOR
4A2AH+b	JMP WRITE	; WRITE SELECTED SECTOR
4A2DH+b	JMP LISTST	; RETURN LIST STATUS
4A30H+b	JMP SECTRAN	; SECTOR TRANSLATE SUBROUTINE

Each jump address corresponds to a particular subroutine that performs the specific function, as outlined below. There are three major divisions in the jump table: the system (re)initialization, which results from calls on BOOT and WBOOT; simple character I/O performed by calls on CONST, CONIN, CONOUT, LIST, PUNCH, READER, and LISTST; and diskette I/O performed by calls on HOME, SELDSK, SETTRK, SETSEC, SETDMA, READ, WRITE, and SECTRAN.

All simple character I/O operations are assumed to be performed in ASCII, upper and lower case, with high order (parity bit) set to zero. An end-of-file condition for an input device is given by an ASCII control-z (1AH). Peripheral devices are seen by CP/M as "logical" devices and are assigned to physical devices within the BIOS.

To operate, the BDOS needs only the CONST, CONIN, and CONOUT subroutines (LIST, PUNCH, and READER may be used by PIP, but not the BDOS). Further, the LISTST entry is currently used only by DESPOOL, the print spooling utility. Thus, the initial version of CBIOS may have empty subroutines for the remaining ASCII devices.

The characteristics of each device are

CONSOLE	The principal interactive console that communicates with the operator, accessed through CONST, CONIN, and CONOUT; typically, the CONSOLE is a device such as a CRT or teletype.
LIST	The principal listing device, if it exists on the user's system, is usually a hard-copy device, such as a printer or teletype.
PUNCH	The principal tape punching device, if it exists, is normally a high-speed paper tape punch or teletype.
READER	The principal tape reading device, such as a simple optical reader or teletype.

A single peripheral can be assigned as the LIST, PUNCH, and READER device simultaneously. If no peripheral device is assigned as the LIST, PUNCH, or READER device, the CBIOS created by the user may give an appropriate error message so that the system does not "hang" if the device is accessed by PIP or some other user program. Alternately, the PUNCH and LIST routines can just simply return, and the READER routine can return with a 1AH (ctl-Z) in register A to indicate immediate end-of-file.

For added flexibility, the user can optionally implement the "IOBYTE" function, which allows reassignment of physical and logical devices. The IOBYTE function creates a mapping of logical to physical devices that can be altered during CP/M processing (the user should see the STAT command). The definition of the IOBYTE function corresponds to the Intel standard as follows: a single location in memory (currently location 0003H) is maintained, called IOBYTE, which defines the logical to physical device mapping that is in effect at a particular time. The mapping is performed by splitting the

IOBYTE into four distinct fields of two bits each, called the CONSOLE, READER, PUNCH, and LIST fields, as shown below.

	most significant		least significant	
IOBYTE AT 003H	LIST	PUNCH	READER	CONSOLE
	bits 6, 7	bits 4, 5	bits 2, 3	bits 0, 1

The value in each field can be in the range 0-3, defining the assigned source or destination of each logical device. The values that can be assigned to each field are given below

**CONSOLE field (bits 0,1)**

- 0 console is assigned to the console printer device (TTY:)
- 1 console is assigned to the CRT device (CRT:)
- 2 batch mode: use the READER as the CONSOLE input, and the LIST device as the CONSOLE output (BAT:)
- 3 user defined console device (UC1:)

**READER field (bits 2,3)**

- 0 READER is the teletype device (TTY:)
- 1 READER is the high speed reader device (PTR:)
- 2 user defined reader # 1 (UR1:)
- 3 user defined reader # 2 (UR2:)

**PUNCH field (bits 4,5)**

- 0 PUNCH is the teletype device (TTY:)
- 1 PUNCH is the high speed punch device (PTP:)
- 2 user defined punch # 1 (UP1:)
- 3 user defined punch # 2 (UP2:)

**LIST field (bits 6,7)**

- 0 LIST is the teletype device (TTY:)
- 1 LIST is the CRT device (CRT:)
- 2 LIST is the line printer device (LPT:)
- 3 user defined list device (UL1:)

The implementation of the IOBYTE is optional and affects only the organization of the CBIOS. No CP/M systems use the IOBYTE (although they tolerate the existence of the IOBYTE at location 0003H), except for PIP, which allows access to the physical devices, and STAT, which allows logical-physical assignments to be made or displayed (for more information, the user should see Chapter 1). In any case the IOBYTE implementation should be omitted until the basic CBIOS is fully implemented and tested; then the user should add the IOBYTE to increase the facilities.

Disk I/O is always performed through a sequence of calls on the various disk access subroutines that set up the disk number to access, the track and sector on a particular disk, and the direct memory access (DMA) address involved in the I/O operation. After all these parameters have been set up, a call is made to the READ or WRITE function to perform the actual I/O operation. There is often a single call to SELDSK to select a disk drive, followed by a number of read or write operations to the selected disk before selecting another drive for subsequent operations. Similarly, there may be a single call to set the DMA address, followed by several calls that read or write from the selected DMA address before the DMA address is changed. The track and sector subroutines are always called before the READ or WRITE operations are performed.

The READ and WRITE routines should perform several retries (10 is standard) before reporting the error condition to the BDOS. If the error condition is returned to the BDOS, it will report the error to the user. The HOME subroutine may or may not

actually perform the track 00 seek, depending upon controller characteristics; the important point is that track 00 has been selected for the next operation and is often treated in exactly the same manner as SETTRK with a parameter of 00.

The exact responsibilities of each entry point subroutine are given below.

**BOOT** The BOOT entry point gets control from the cold start loader and is responsible for basic system initialization, including sending a sign-on message (which can be omitted in the first version). If the IOBYTE function is implemented, it must be set at this point. The various system parameters that are set by the WBOOT entry point must be initialized, and control is transferred to the CCP at 3400+b for further processing. Note that register C must be set to zero to select drive A.

The WBOOT entry point gets control when a warm start occurs. A warm start is performed whenever a user program branches to location 0000H, or when the CPU is reset from the front panel. The CP/M system must be loaded from the first two tracks of drive A up to, but not including, the BIOS (or CBIOS, if the user has completed the patch). System parameters must be initialized as shown below:

location 0,1,2	Set to JMP WBOOT for warm starts (000H: JMP 4A03H+b)
location 3	Set initial value of IOBYTE, if implemented in the CBIOS
location 4	High nibble = current user no; low nibble = current drive
location 5,6,7	Set to JMP BDOS, which is the primary entry point to CP/M for transient programs. (0005H: JMP 3C06H+b)

(The user should refer to Section 6.9 for complete details of page zero use.) Upon completion of the initialization, the WBOOT program must branch to the CCP at 3400H+b to (re)start the system. Upon entry to the CCP, register C is set to the drive to select after system initialization. The WBOOT routine should read location 4 in memory, verify that it is a legal drive, and pass it to the CCP in register C.

**CONST** The user should sample the status of the currently assigned console device and return 0FFH in register A if a character is ready to read and 00H in register A if no console characters are ready.

**CONIN** The next console character is read into register A, and the parity bit is set (high order bit) to zero. If no console character is ready, the user waits until a character is typed before returning.

CONOUT	The user sends the character from register C to the console output device. The character is in ASCII, with high order parity bit set to zero. The user may want to include a time-out on a line feed or carriage return, if the console device requires some time interval at the end of the line (such as a TI Silent 700 terminal). The user can filter out control characters that cause the console device to react in a strange way (a control-z causes the Lear Seigler terminal to clear the screen, for example).
LIST	The user sends the character from register C to the currently assigned listing device. The character is in ASCII with zero parity bit.
PUNCH	The user sends the character from register C to the currently assigned punch device. The character is in ASCII with zero parity.
READER	The user reads the next character from the currently assigned reader device into register A with zero parity (high order bit must be zero); an end-of-file condition is reported by returning an ASCII control-z(1AH).
HOME	The user moves the disk head of the currently selected disk (initially disk A) to the track 00 position. If the controller allows access to the track 0 flag from the drive, the head is stepped until the track 0 flag is detected. If the controller does not support this feature, the HOME call is translated into a call to SETTRK with a parameter of 0.
SELDSK	The user selects the disk drive given by register C for further operations, where register C contains 0 for drive A, 1 for drive B, and so on up to 15 for drive P (the standard CP/M distribution version supports four drives). On each disk select, SELDSK must return in HL the base address of a 16-byte area, called the Disk Parameter Header, described in Section 6.10. For standard floppy disk drives, the contents of the header and associated tables do not change; thus, the program segment included in the sample CBIOS performs this operation automatically. If there is an attempt to select a nonexistent drive, SELDSK returns HL=0000H as an error indicator. Although SELDSK must return the header address on each call, it is advisable to postpone the physical disk select operation until an I/O function (seek, read, or write) is actually performed, since disk selects often occur without ultimately performing any disk I/O, and many controllers will unload the head of the current disk before selecting the new drive. This would cause an excessive amount of noise and disk wear. The least significant bit of register E is zero if this is the first occurrence of the drive select since the last cold or warm start.
SETTRK	Register BC contains the track number for subsequent disk accesses on the currently selected drive. The sector number in BC is the same as the number returned from the SECTTRAN entry point. The user can choose to seek the selected track at

this time or delay the seek until the next read or write actually occurs. Register BC can take on values in the range 0-76 corresponding to valid track numbers for standard floppy disk drives and 0-65535 for nonstandard disk subsystems.

- SETSEC** Register BC contains the sector number (1 through 26) for subsequent disk accesses on the currently selected drive. The sector number in BC is the same as the number returned from the SECTTRAN entry point. The user can choose to send this information to the controller at this point or delay sector selection until a read or write operation occurs.
- SETDMA** Register BC contains the DMA (disk memory access) address for subsequent read or write operations. For example, if B = 00H and C = 80H when SETDMA is called, all subsequent read operations read their data into 80H through 0FFH and all subsequent write operations get their data from 80H through 0FFH, until the next call to SETDMA occurs. The initial DMA address is assumed to be 80H. The controller need not actually support direct memory access. If, for example, all data transfers are through I/O ports, the CBIOS that is constructed will use the 128-byte area starting at the selected DMA address for the memory buffer during the subsequent read or write operations.
- READ** Assuming the drive has been selected, the track has been set, the sector has been set, and the DMA address has been specified, the READ subroutine attempts to read one sector based upon these parameters and returns the following error codes in register A:
- 0 no errors occurred
  - 1 nonrecoverable error condition occurred
- Currently, CP/M responds only to a zero or nonzero value as the return code. That is, if the value in register A is 0, CP/M assumes that the disk operation was completed properly. If an error occurs, however, the CBIOS should attempt at least 10 retries to see if the error is recoverable. When an error is reported the BDOS will print the message "BDOS ERR ON x: BAD SECTOR". The operator then has the option of typing carriage-return to ignore the error, or ctl-C to abort.
- WRITE** The user writes the data from the currently selected DMA address to the currently selected drive, track, and sector. For floppy disks, the data should be marked as "nondeleted data" to maintain compatibility with other CP/M systems. The error codes given in the READ command are returned in register A, with error recovery attempts as described above.
- LISTST** The user returns the ready status of the list device used by the DESPOOL program to improve console response during its operation. The value 00 is returned in A if the list device is not ready to accept a character and 0FFH if a character can be sent

to the printer. A 00 value should be returned if LIST status is not implemented.

#### SECTRAN

The user performs logical to physical sector translation to improve the overall response of CP/M. Standard CP/M systems are shipped with a "skew factor" of 6, where six physical sectors are skipped between each logical read operation. This skew factor allows enough time between sectors for most programs to load their buffers without missing the next sector. In particular computer systems that use fast processors, memory, and disk subsystems, the skew factor may be changed to improve overall response. However, the user should maintain a single density IBM-compatible version of CP/M for information transfer into and out of the computer system, using a skew factor of 6. In general, SECTRAN receives a logical sector number relative to zero in BC and a translate table address in DE. The sector number is used as an index into the translate table, with the resulting physical sector number in HL. For standard systems, the table and indexing code is provided in the CBIOS and need not be changed.

## 6.7 A Sample BIOS

The program shown in Appendix B can serve as a basis for a user's first BIOS. The simplest functions are assumed in this BIOS, so that the user can enter it through a front panel, if absolutely necessary. The user must alter and insert code into the subroutines for CONST, CONIN, CONOUT, READ, WRITE, and WAITIO subroutines. Storage is reserved for user-supplied code in these regions. The scratch area reserved in page zero (see section 6.9) for the BIOS is used in this program, so that it could be implemented in ROM, if desired.

Once operational, this skeletal version can be enhanced to print the initial sign-on message and perform better error recovery. The subroutines for LIST, PUNCH, and READER can be filled out and the IOBYTE function can be implemented.

## 6.8 A Sample Cold Start Loader

The program shown in Appendix E can serve as a basis for a cold start loader. The disk read function must be supplied by the user, and the program must be loaded somehow starting at location 0000. Space is reserved for the patch code so that the total amount of storage required for the cold start loader is 128 bytes. Eventually, the user will probably want to get this loader onto the first disk sector (track 0, sector 1) and cause the controller to load it into memory automatically upon system start up. Alternatively, the cold start loader can be placed into ROM, and above the CP/M system. In this case, it will be necessary to originate the program at a higher address and key in a jump instruction at system start up that branches to the loader. Subsequent warm starts will not require this key-in operation, since the entry point WBOOT gets control thus bringing the system in from disk automatically. The skeletal cold start loader has minimal error recover, which may be enhanced in later versions.

## 6.9 Reserved Locations in Page Zero

Main memory page zero, between locations 00H and 0FFH, contains several segments of code and data that are used during CP/M processing. The code and data areas are given below for reference

Locations from      to	Contents
0000H-0002H	Contains a jump instruction to the warm start entry point at location 4A03H+b. This allows a simple programmed restart (JMP 0000H) or manual restart from the front panel.
0003H-0003H	Contains the Intel standard IOBYTE, which is optionally included in the user's CBIOS, as described in Section 6.6.
0004H-0004H	Current default drive number (0=A,...,15=P).
0005H-0007H	Contains a jump instruction to the BDOS and serves two purposes: JMP 0005H provides the primary entry point to the BDOS, as described in Chapter 5, and LHLD 0006H brings the address field of the instruction to the HL register pair. This value is the lowest address in memory used by CP/M (assuming the CCP is being overlaid). The DDT program will change the address field to reflect the reduced memory size in debug mode.
0008H-0027H	(Interrupt locations 1 through 5 not used.)
0030H-0037H	(Interrupt location 6, not currently used; reserved.)
0038H-003AH	Restart 7; contains a jump instruction into the DDT or SID program when running in debug mode for programmed breakpoints, but is not otherwise used by CP/M.
003BH-003FH	(Not currently used; reserved.)
0040H-004FH	A 16-byte area reserved for scratch by CBIOS, but is not used for any purpose in the distribution version of CP/M.
0050H-005BH	(Not currently used; reserved.)
005CH-007CH	Default file control block produced for a transient program by the Console Command Processor.
007DH-007FH	Optional default random record position.
0080H-00FFH	Default 128-byte disk buffer (also filled with the command line when a transient is loaded under the CCP).

This information is set up for normal operation under the CP/M system, but can be overwritten by a transient program if the BDOS facilities are not required by the transient.

If, for example, a particular program performs only simple I/O and must begin execution at location 0, it can first be loaded into the TPA, using normal CP/M facilities, with a small memory move program that gets control when loaded (the memory move program must get control from location 0100H, which is the assumed beginning of all transient programs). The move program can then proceed to move the entire memory image down to location 0 and pass control to the starting address of the memory load. If the BIOS is overwritten or if location 0 (containing the warm start entry point) is overwritten, the operator must bring the CP/M system back into memory with a cold start sequence.

## 6.10 Disk Parameter Tables

Tables are included in the BIOS that describe the particular characteristics of the disk subsystem used with CP/M. These tables can be either hand-coded, as shown in the sample CBIOS in Appendix B, or automatically generated using the DISKDEF macro library, as shown in Appendix F. The purpose here is to describe the elements of these tables.

In general, each disk drive has an associated (16-byte) disk parameter header that contains information about the disk drive and provides a scratchpad area for certain BDOS operations. The format of the disk parameter header for each drive is shown below.

Disk Parameter Header							
XLT	0000	0000	0000	DIRBUF	DPB	CSV	ALV
16b	16b	16b	16b	16b	16b	16b	16b

where each element is a word (16-bit) value. The meaning of each Disk Parameter Header (DPH) element is

XLT	Address of the logical to physical translation vector, if used for this particular drive, or the value 0000H if no sector translation takes place (i.e., the physical and logical sector numbers are the same). Disk drives with identical sector skew factors share the same translate tables.
0000	Scratchpad values for use within the BDOS (initial value is unimportant).
DIRBUF	Address of a 128-byte scratchpad area for directory operations within BDOS. All DPHs address the same scratchpad area.
DPB	Address of a disk parameter block for this drive. Drives with identical disk characteristics address the same disk parameter block.
CSV	Address of a scratchpad area used for software check for changed disks. This address is different for each DPH.
ALV	Address of a scratchpad area used by the BDOS to keep disk storage allocation information. This address is different for each DPH.



Given n disk drives, the DPHs are arranged in a table whose first row of 16 bytes corresponds to drive 0, with the last row corresponding to drive n-1. The table thus appears as

DPBASE:

00	XLT 00	0000	0000	0000	DIRBUF	DBP 00	CSV 00	ALV 00
01	XLT 01	0000	0000	0000	DIRBUF	DBP 01	CSV 01	ALV 01
(and so on through)								
n-1	XLTn-1	0000	0000	0000	DIRBUF	DBPn-1	CSVn-1	ALVn-1

where the label DPBASE defines the base address of the DPH table.

A responsibility of the SELDSK subroutine is to return the base address of the DPH for the selected drive. The following sequence of operations returns the table address, with a 0000H returned if the selected drive does not exist.

```

NDISKS      EQU      4          ;NUMBER OF DISK DRIVES
.....
SELDISK:    ;SELECT DISK GIVEN BY BC
            LXI      H,0000H    ;ERROR CODE
            MOV      A,C        ;DRIVE OK?
            CPI      NDISKS     ;CY IF SO
            RNC                      ;RET IF ERROR
            ;NO ERROR, CONTINUE
            MOV      L,C        ;LOW(DISK)
            MOV      H,B        ;HIGH(DISK)
            DAD      H          ;*2
            DAD      H          ;*4
            DAD      H          ;*8
            DAD      H          ;*16
            LXI      D,DPBASE;FIRST DPH
            DAD      D          ;DPH(DISK)
            RET

```

The translation vectors (XLT 00 through XLTn-1) are located elsewhere in the BIOS, and simply correspond one-for-one with the logical sector numbers zero through the sector count I. The Disk Parameter Block (DPB) for each drive is more complex. A particular DPB, which is addressed by one or more DPHs, takes the general form

SPT	BSH	BLM	EXM	DSM	DRM	AL0	AL1	CKS	OFF
16b	8b	8b	8b	16b	16b	8b	8b	16b	16b

where each is a byte or word value, as shown by the 8b or 16b indicator below the field.

SPT is the total number of sectors per track.

BSH is the data allocation block shift factor, determined by the data block allocation size.

BLM is the data allocation block mask (2[BSH-1]).

EXM is the extent mask, determined by the data block allocation size and the number of disk blocks.

DSM determines the total storage capacity of the disk drive.

DRM	determines the total number of directory entries that can be stored on this drive. (AL0,AL1 determine reserved directory blocks.)
CKS	is the size of the directory check vector.
OFF	is the number of reserved tracks at the beginning of the (logical) disk.

The values of BSH and BLM determine (implicitly) the data allocation size BLS, which is not an entry in the DPB. Given that the designer has selected a value for BLS, the values of BSH and BLM are shown in the tabulation below.

BLS	BSH	BLM
1024	3	7
2048	4	15
4096	5	31
8192	6	63
16384	7	127

where all values are in decimal. The value of EXM depends upon both the BLS and whether the DSM value is less than 256 or greater than 255. For  $DSM < 256$  the value of EXM is given by:

BLS	EXM
1024	0
2048	1
4096	3
8192	7
16384	15

For  $DSM > 255$  the value of EXM is given by:

BLS	EXM
1024	N/A
2048	0
4096	1
8192	3
16384	7

The value of DSM is the maximum data block number supported by this particular drive, measured in BLS units. The product BLS times (DSM+1) is the total number of bytes held by the drive and, of course, must be within the capacity of the physical disk, not counting the reserved operating system tracks.

The DRM entry is the one less than the total number of directory entries that can take on a 16-bit value. The values of AL0 and AL1, however, are determined by DRM. The values AL0 and AL1 can together be considered a string of 16-bits, as shown below.

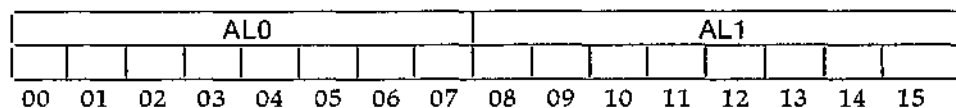

where position 00 corresponds to the high order bit of the byte labeled AL0 and 15 corresponds to the low order bit of the byte labeled AL1. Each bit position reserves a data block for number of directory entries, thus allowing a total of 16 data blocks to be

assigned for directory entries (bits are assigned starting at 00 and filled to the right until position 15). Each directory entry occupies 32 bytes, resulting in the tabulation below.

BLS	Directory Entries
1024	32 times # bits
2048	64 times # bits
4096	128 times # bits
8192	256 times # bits
16384	512 times # bits

Thus, if DRM = 127 (128 directory entries) and BLS = 1024, there are 32 directory entries per block, requiring 4 reserved blocks. In this case, the 4 high order bits of AL0 are set, resulting in the values AL0 = 0F0H and AL1 = 00H.

The CKS value is determined as follows: if the disk drive media is removable, then  $CKS = (DRM+1)/4$ , where DRM is the last directory entry number. If the media are fixed, then set CKS = 0 (no directory records are checked in this case).

Finally, the OFF field determines the number of tracks that are skipped at the beginning of the physical disk. This value is automatically added whenever SETTRK is called and can be used as a mechanism for skipping reserved operating system tracks or for partitioning a large disk into smaller segmented sections.

To complete the discussion of the DPB, several DPHs can address the same DPB if their drive characteristics are identical. Further, the DPB can be dynamically changed when a new drive is addressed by simply changing the pointer in the DPH since the BDOS copies the DPB values to a local area whenever the SELDSK function is invoked.

Returning back to the DPH for a particular drive, the two address values CSV and ALV remain. Both addresses reference an area of uninitialized memory following the BIOS. The areas must be unique for each drive, and the size of each area is determined by the values in the DPB.

The size of the area addressed by CSV is CKS bytes, which is sufficient to hold the directory check information for this particular drive. If  $CKS = (DRM+1)/4$ , one must reserve  $(DRM+1)/4$  bytes for directory check use. If CKS = 0, no storage is reserved.

The size of the area addressed by ALV is determined by the maximum number of data blocks allowed for this particular disk and is computed as  $(DSM/8)+1$ .

The CBIOS shown in Appendix B demonstrates an instance of these tables for standard 8-inch single density drives. It may be useful to examine this program and compare the tabular values with the definitions given above.

## 6.11 The DISKDEF Macro Library

A macro library is shown in Appendix F, called DISKDEF, which greatly simplifies the table construction process. One must have access to the MAC macro assembler, of course, to use the DISKDEF facility, while the macro library is included with all CP/M 2 distribution disks.

A BIOS disk definition consists of the following sequence of macro statements:

```

MACLIB      DISKDEF
.....
DISKS       n
DISKDEF     0,...
DISKDEF     1,...
```

```

.....
DISKDEF      n-1
.....
ENDEF

```

where the MACLIB statement loads the DISKDEF.LIB file (on the same disk as the BIOS) into MAC's internal tables. The DISKS macro call follows, which specifies the number of drives to be configured with the user's system, where n is an integer in the range 1 to 16. A series of DISKDEF macro calls then follow that define the characteristics of each logical disk, 0 through n-1 (corresponding to logical drives A through P). The DISKS and DISKDEF macros generate the in-line fixed data tables described in the previous section and thus must be placed in a nonexecutable portion of the BIOS, typically directly following the BIOS jump vector.

The remaining portion of the BIOS is defined following the DISKDEF macros, with the ENDEF macro call immediately preceding the END statement. The ENDEF (End of Diskdef) macro generates the necessary uninitialized RAM areas, which are located in memory above the BIOS.

The form of the DISKDEF macro call is

```
DISKDEF  dn,fsc,lsc,[skf],bls,dks,dir,cks,ofs,[0]
```

where

dn	is the logical disk number, 0 to n-1.
fsc	is the first physical sector number (0 or 1).
lsc	is the last sector number.
skf	is the optional sector skew factor.
bls	is the data allocation block size.
dks	is the number of blocks on the disk.
dir	is the number of directory entries.
cks	is the number of "checked" directory entries.
ofs	is the track offset to logical track 00.
[0]	is an optional 1.4 compatibility flag.

The value dn is the drive number being defined with this DISKDEF macro invocation. The fsc parameter accounts for differing sector numbering systems and is usually 0 or 1. The lsc is the last numbered sector on a track. When present, the skf parameter defines the sector skew factor, which is used to create a sector translation table according to the skew.

If the number of sectors is less than 256, a single-byte table is created, otherwise each translation table element occupies two bytes. No translation table is created if the skf parameter is omitted (or equal to 0). The bls parameter specifies the number of bytes allocated to each data block, and takes on the values 1024, 2048, 4096, 8192, or 16384. Generally, performance increases with larger data block sizes since there are fewer directory references and logically connected data records are physically close on the disk. Further, each directory entry addresses more data and the BIOS-resident ram space is reduced.

The dks parameter specifies the total disk size in bls units. That is, if the bls = 2048 and dks = 1000, the total disk capacity is 2,048,000 bytes. If dks is greater than 255, the block size parameter bls must be greater than 1024. The value of dir is the total number of directory entries, which may exceed 255, if desired. The cks parameter determines the

number of directory items to check on each directory scan and is used internally to detect changed disks during system operation, where an intervening cold or warm start has not occurred (when this situation is detected, CP/M automatically marks the disk read/only so that data are not subsequently destroyed).

As stated in the previous section, the value of cks = dir when the medium is easily changed, as is the case with a floppy disk subsystem. If the disk is permanently mounted, the value of cks is typically 0, since the probability of changing disks without a restart is low. The ofs value determines the number of tracks to skip when this particular drive is addressed, which can be used to reserve additional operating system space or to simulate several logical drives on a single large capacity physical drive. Finally, the [0] parameter is included when file compatibility is required with versions of 1.4 that have been modified for higher density disks. This parameter ensures that only 16K is allocated for each directory record, as was the case for previous versions. Normally, this parameter is not included.

For convenience and economy of table space, the special form

```
DISKDEF      i,j
```

gives disk i the same characteristics as a previously defined drive j. A standard four-drive single density system, which is compatible with version 1.4, is defined using the following macro invocations:

```
DISKS          4
DISKDEF        0,1,26,6,1024,243,64,64,2
DISKDEF        1,0
DISKDEF        2,0
DISKDEF        3,0
...
ENDEF
```

with all disks having the same parameter values of 26 sectors per track (numbered 1 through 26), with 6 sectors skipped between each access, 1024 bytes per data block, 243 data blocks for a total of 243K-byte disk capacity, 64 checked directory entries, and two operating system tracks.

The DISKS macro generates n DPHs, starting at the DPH table address DPBASE generated by the macro. Each disk header block contains sixteen bytes, as described above, and correspond one-for-one to each of the defined drives. In the four-drive standard system, for example, the DISKS macro generates a table of the form:

```
DPBASE        EQU $
DPE0:         DW  XLT0,0000H,0000H,0000H,DIRBUF,DPB0,CSV0,ALV0
DPE1:         DW  XLT0,0000H,0000H,0000H,DIRBUF,DPB0,CSV1,ALV1
DPE2:         DW  XLT0,0000H,0000H,0000H,DIRBUF,DPB0,CSV2,ALV2
DPE3:         DW  XLT0,0000H,0000H,0000H,DIRBUF,DPB0,CSV3,ALV3
```

where the DPH labels are included for reference purposes to show the beginning table addresses for each drive 0 through 3. The values contained within the DPH are described in detail in the previous section. The check and allocation vector addresses are generated by the ENDEF macro in the ram area following the BIOS code and tables.

The user should note that if the skf (skew factor) parameter is omitted (or equal to 0), the translation table is omitted and a 0000H value is inserted in the XLT position of the DPH for the disk. In a subsequent call to perform the logical to physical translation, SECTTRAN receives a translation table address of DE = 0000H and simply returns the original logical sector from BC in the HL register pair. A translate table is constructed when the skf parameter is present, and the (nonzero) table address is placed into the

corresponding DPHs. The tabulation shown below, for example, is constructed when the standard skew factor  $skf = 6$  is specified in the DISKDEF macro call:

```

XLT0:      DB      1,7,13,19,25,5,11,17,23,3,9,15,21
           DB      2,8,14,20,26,6,12,18,24,4,10,16,22

```

Following the ENDEF macro call, a number of uninitialized data areas are defined. These data areas need not be a part of the BIOS that is loaded upon cold start, but must be available between the BIOS and the end of memory. The size of the uninitialized RAM area is determined by EQU statements generated by the ENDEF macro. For a standard four-drive system, the ENDEF macro might produce

```

4C72 =      BEGDAT EQU $
           (data areas)
4DB0 =      ENDDAT EQU $
013C =      DATSIZ EQU $-BEGDAT

```

which indicates that uninitialized RAM begins at location 4C72H, ends at 4DB0H-1, and occupies 013CH bytes. The user must ensure that these addresses are free for use after the system is loaded.

After modification, the user can utilize the STAT program to check drive characteristics, since STAT uses the disk parameter block to decode the drive information. The STAT command form

```
STAT d:DSK:
```

decodes the disk parameter block for drive d (d=A,...,P) and displays the values shown below.

```

r: 128-byte record capacity
k: kilobyte drive capacity
d: 32-byte directory entries
c: checked directory entries
e: records/extent
b: records/block
s: sectors/track
t: reserved tracks

```

Three examples of DISKDEF macro invocations are shown below with corresponding STAT parameter values (the last produces a full 8-megabyte system).

```

r=4096,      DISKDEF 0,1,58,,2048,256,128,128,2
           k=512, d=128, c=128, e=256, b=16, s=58, t=2
r=16384,     DISKDEF 0,1,58,,2048,1024,300,0,2
           k=2048, d=300, c=0, e=128, b=16, s=58, t=2
r=65536,     DISKDEF 0,1,58,,16384,512,128,128,2
           k=8192, d=128, c=128, e=1024, b=128, s=58, t=2

```

## 6.12 Sector Blocking and Deblocking

Upon each call to the BIOS WRITE entry point, the CP/MBDOS includes information that allows effective sector blocking and deblocking where the host disk subsystem has a sector size that is a multiple of the basic 128-byte unit. The purpose here is to present a general-purpose algorithm that can be included within the BIOS and that uses the BDOS information to perform the operations automatically.

On each call to WRITE, the BDOS provides the following information in register C:

0	=	normal sector write
1	=	write to directory sector
2	=	write to the first sector of a new data block

Condition 0 occurs whenever the next write operation is into a previously written area, such as a random mode record update, when the write is to other than the first sector of an unallocated block, or when the write is not into the directory area. Condition 1 occurs when a write into the directory area is performed. Condition 2 occurs when the first record (only) of a newly allocated data block is written. In most cases, application programs read or write multiple 128-byte sectors in sequence; thus, there is little overhead involved in either operation when blocking and deblocking records, since preread operations can be avoided when writing records.

Appendix G lists the blocking and deblocking algorithms in skeletal form (this file is included on your CP/M disk). Generally, the algorithms map all CP/M sector read operations onto the host disk through an intermediate buffer that is the size of the host disk sector. Throughout the program, values and variables that relate to the CP/M sector involved in a seek operation are prefixed by sek, while those related to the host disk system are prefixed by hst. The equate statements beginning on line 29 of Appendix G define the mapping between CP/M and the host system, and must be changed if other than the sample host system is involved.

The entry points BOOT and WBOOT must contain the initialization code starting on line 57, while the SELDSK entry point must be augmented by the code starting on line 65. The user should note that although the SELDSK entry point computes and returns the Disk Parameter Header address, it does not physically select the host disk at this point (it is selected later at READHST or WRITEHST). Further, SETTRK, SETTRK, and SETDMA simply store the values, but do not take any other action at this point. SECTRAN performs a trivial function of returning the physical sector number.

The principal entry points are READ and WRITE, starting on lines 110 and 125, respectively. These subroutines take the place of your previous READ and WRITE operations.

The actual physical read or write takes place at either WRITEHST or READHST, where all values have been prepared: hstdsk is the host disk number, hstrk is the host track number, and hstsec is the host sector number (which may require translation to a physical sector number). The user must insert code at this point that performs the full host sector read or write into or out of the buffer at hstbuf of length hstsiz. All other mapping functions are performed by the algorithms.

This particular algorithm was tested using an 80-megabyte hard disk unit that was originally configured for 128-byte sectors, producing approximately 35 megabytes of formatted storage. When configured for 512-byte host sectors, usable storage increased to 57 megabytes, with a corresponding 400% improvement in overall response. In this situation, there is no apparent overhead involved in deblocking sectors, with the advantage that user programs still maintain 128-byte sectors. This is primarily because of the information provided by the BDOS, which eliminates the necessity for preread operations.

## Appendix A: The MDS Basic I/O System (BIOS)

```

1          ;      mds-800 i/o drivers for cp/m 2.2
2          ;      (four drive single density version)
3          ;
4          ;      version 2.2 february, 1980
5          ;
6      0016 =      vers      equ      22          ;version 2.2
7          ;
8          ;      copyright (c) 1980
9          ;      digital research
10         ;      box 579, pacific grove
11         ;      california, 93950
12         ;
13         ;
14      ffff =      true      equ      0ffffh      ;value of "true"
15      0000 =      false     equ      not true    ;"false"
16      0000 =      test      equ      false      ;true if test bios
17         ;
18         ;      if      test
19         bias     equ      03400h      ;base of ccp in test system
20         ;      endif
21         ;      if      not test
22      0000 =      bias     equ      0000h      ;generate relocatable cp/m system
23         ;      endif
24         ;
25      1600 =      patch     equ      1600h
26         ;
27      1600         org      patch
28      0000 =      cpmb     equ      $-patch    ;base of cpm console processor
29      0806 =      bdos     equ      806h+cpmb ;basic dos (resident portion)

```



```

30      1600 =          cpmi      equ      $-cpmb      ;length (in bytes) of cpm system
31      002c =          nsects    equ      cpmi/128     ;number of sectors to load
32      0002 =          offset    equ      2           ;number of disk tracks used by cp/m
33      0004 =          cdisk     equ      0004h       ;address of last logged disk on warm start
34      0080 =          buff      equ      0080h       ;default buffer address
35      000a =          retry     equ      10          ;max retries on disk i/o before error
36      ;
37      ;          perform following functions
38      ;          boot          cold start
39      ;          wboot        warm start (save i/o byte)
40      ;          (boot and wboot are the same for mds)
41      ;          const        console status
42      ;          reg-a = 00 if no character ready
43      ;          reg-a = ff if character ready
44      ;          conin         console character in (result in reg-a)
45      ;          conout        console character out (char in reg-c)
46      ;          list         list out (char in reg-c)
47      ;          punch        punch out (char in reg-c)
48      ;          reader        paper tape reader in (result to reg-a)
49      ;          home         move to track 00
50      ;
51      ;          (the following calls set-up the io parameter block for the
52      ;          mds, which is used to perform subsequent reads and writes)
53      ;          seldsk        select disk given by reg-c (0, 1, 2, ...)
54      ;          settrk        set track address (0, ... 76) for subsequent read/write
55      ;          setsec        set sector address (1, ... , 26) for subsequent read/write
56      ;          setdma        set subsequent dma address (initially 80h)
57      ;
58      ;          (read and write assume previous calls to set up the io parameters)
59      ;          read          read track/sector to preset dma address
60      ;          write         track/sector from preset dma address
61      ;
62      ;          jump vector for individual routines
63      1600 c3b316      jmp          boot

```

```

64      1603 c3c316      wboote: jmp      wboot
65      1606 c36117                jmp      const
66      1609 c36417                jmp      conin
67      160c c36a17                jmp      conout
68      160f c36d17                jmp      list
69      1612 c37217                jmp      punch
70      1615 c37517                jmp      reader
71      1618 c37817                jmp      home
72      161b c37d17                jmp      seldsk
73      161e c3a717                jmp      settrk
74      1621 c3ac17                jmp      setsec
75      1624 c3bb17                jmp      setdma
76      1627 c3c117                jmp      read
77      162a c3ca17                jmp      write
78      162d c37017                jmp      listst      ;list status
79      1630 c3b117                jmp      sectran
80
81      ;
82      maclib      diskdef      ;load the disk definition library
83      disks      4              ;four disks
84      1633+=      dpbase      equ      $          ;base of disk parameter blocks
85      1637+00000000      dpe0:      dw      xlt0, 0000h      ;translate table
86      163b+6e187316                dw      0000h, 0000h      ;scratch area
87      163f+0d19ee18                dw      dirbuf, dpb0      ;dir buff, parm block
88      1643+82160000                dw      csv0, alv0        ;check, alloc vectors
89      1647+00000000      dpe1:      dw      xlt1, 0000h      ;translate table
90      164b+6e187316                dw      0000h, 0000h      ;scratch area
91      164f+3c191d19                dw      dirbuf, dpb1      ;dir buff, parm block
92      1653+82160000                dw      csv1, alv1        ;check, alloc vectors
93      1657+00000000      dpe2:      dw      xlt2, 0000h      ;translate table
94      165b+6e187316                dw      0000h, 0000h      ;scratch area
95      165f+6b194c19                dw      dirbuf, dpb2      ;dir buff, parm block
96      1663+82160000                dw      csv2, alv2        ;check, alloc vectors
97      1667+00000000      dpe3:      dw      xlt3, 0000h      ;translate table
98      166b+00000000                dw      0000h, 0000h      ;scratch area

```

98	166b+6e187316		dw	dirbuf, dpb3	;check, alloc block
99	166f+9a197b19		dw	csv3, alv3	;dir buff, parm vectors
100			diskdef	0, 1, 26, 6, 1024, 243, 64, 64,	offset
101	1673+e	dpb0	equ	\$	;disk parm block
102	1673+1a00		dw	26	;sec per track
103	1675+03		db	3	;block shift
104	1676+07		db	7	;block mask
105	1677+00		db	0	;extnt mask
106	1678+f200		dw	242	;disk size-1
107	167a+3f00		dw	63	;directory max
108	167c+c0		db	192	;alloc0
109	167d+00		db	0	;alloc1
110	167e+1000		dw	16	;check size
111	1680+0200		dw	2	;offset
112	1682+e	xlt0	equ	\$	;translate table
113	1682+01		db	1	
114	1683+07		db	7	
115	1684+0d		db	13	
116	1685+13		db	19	
117	1686+19		db	25	
118	1687+05		db	5	
119	1688+0b		db	11	
120	1689+11		db	17	
121	168a+17		db	23	
122	168b+03		db	3	
123	168c+09		db	9	
124	168d+0f		db	15	
125	168e+15		db	21	
126	168f+02		db	2	
127	1690+08		db	8	
128	1691+0e		db	14	
129	1692+14		db	20	
130	1693+1a		db	26	
131	1694+06		db	6	

```

132      1695+0c          db      12
133      1696+12          db      18
134      1697+18          db      24
135      1698+04          db      4
136      1699+0a          db      10
137      169a+10          db      16
138      169b+16          db      22
139                                diskdef  1, 0
140      1673+=          dpb1  equ      dpb0      ;equivalent parameters
141      001f+=          als1  equ      als0      ;same allocation vector size
142      0010+=          css1  equ      css0      ;same checksum vector size
143      1682+=          xlt1  equ      xlt0      ;same translate table
144                                diskdef  2, 0
145      1673+=          dpb2  equ      dpb0      ;equivalent parameters
146      001f+=          als2  equ      als0      ;same allocation vector size
147      0010+=          css2  equ      css0      ;same checksum vector size
148      1682+=          xlt2  equ      xlt0      ;same translate table
149                                diskdef  3, 0
150      1673+=          dpb3  equ      dpb0      ;equivalent parameters
151      001f+=          als3  equ      als0      ;same allocation vector size
152      0010+=          css3  equ      css0      ;same checksum vector size
153      1682+=          xlt3  equ      xlt0      ;same translate table
154                                ;
155                                ;
156                                ;      end of controller—independent code, the remaining subroutines
157                                ;      are tailored to the particular operating environment, and must
158                                ;      be altered for any system which differs from the intel mds.
159                                ;
160                                ;      the following code assumes the mds monitor exists at 0f800h
161                                ;      and uses the i/o subroutines within the monitor
162                                ;
163                                ;      we also assume the mds system has four disk drives
164      00fd =          revrt  equ      0fdh      ;interrupt revert port
165      00fc =          intc   equ      0fch      ;interrupt mask port

```

```

166     00f3 =           icon    equ    0f3h           ;interrupt control port
167     007E =           inte    equ    0111$1110b       ;enable rst 0 (warm boot), rst 7 (monitor)
168     ;
169     ;           mds monitor equates
170     f800 =           mon80    equ    0f800h        ;mds monitor
171     ff0f =           rmon80   equ    0ff0fh        ;restart mon80 (boot error)
172     f803 =           ci       equ    0f803h        ;console character to reg-a
173     f806 =           ri       equ    0f806h        ;reader in to reg-a
174     f809 =           co       equ    0f809h        ;console char from c to console out
175     f80c =           po       equ    0f80ch        ;punch char from c to punch device
176     f80f =           lo       equ    0f80fh        ;list from c to list device
177     f812 =           csts     equ    0f812h        ;console status 00/ff to register a
178     ;
179     ;           disk ports and commands
180     0078 =           base     equ    78h           ;base of disk command io ports
181     0078 =           dstat    equ    base         ;disk status (input)
182     0079 =           rtype    equ    base+1       ;result type (input)
183     007b =           rbyte    equ    base+3       ;result byte (input)
184     ;
185     0079 =           ilow     equ    base+1       ;iopb low address (output)
186     007a =           ihigh    equ    base+2       ;iopb high address (output)
187     ;
188     0004 =           readf    equ    4h           ;read function
189     0006 =           writf    equ    6h           ;write function
190     0003 =           recal    equ    3h           ;recalibrate drive
191     0004 =           iordy    equ    4h           ;i/o finished mask
192     000d =           cr       equ    0dh         ;carriage return
193     000a =           lf       equ    0ah         ;line feed
194     ;
195     ;           signon: ;signon message: xxk cp/m vers y.y
196     169c 0d0a0a      db      cr, lf, lf
197     ;           if      test
198     ;           db      '32'           ;32k example bios
199     ;           endif

```

```

200                                     if      not test
201      169f 3030                       db      '00'          ;memory size filled by relocater
202                                     endif
203      16a1 6b2043502f                 db      'k cp/m vers '
204      16ad 322e32                       db      vers/10+'0', ',' vers mod 10+'0'
205      16b0 0d0a00                       db      cr, lf, 0
206                                     ;
207      boot:                            ;print signon message and go to ccp
208                                     ; (note: mds boot initialized lobyte at 0003h)
209      16b3 310001                       lxi     sp, buff+80h
210      16b6 219c16                       lxi     h, signon
211      16b9 cdd317                       call    prmsg      ;print message
212      16bc af                            xra     a          ;clear accumulator
213      16bd 320400                       sta     cdisk     ;set initially to disk a
214      16c0 c30f17                       jmp     gocpm      ;go to cp/m
215                                     ;
216                                     ;
217      wboot:                            loader on track 0, sector 1, which will be skipped for warm
218                                     ; read cp/m from disk—assuming there is a 128 byte cold start
219                                     ; start
220                                     ;
221      16c3 318000                       lxi     sp, buff  ;using dma—thus 80 thru ff available for stack
222                                     ;
223      16c6 0e0a                       mvi     c, retry  ;max retries
224      16c8 c5                            push    b
225      wboot0:                          ;enter here on error retries
226      16c9 010000                       lxi     b, cpmb   ;set dma address to start of disk system
227      16cc cdbb17                       call    setdma
228      16cf 0e00                       mvi     c, 0      ;boot from drive 0
229      16d1 cd7d17                       call    seldsk
230      16d4 0e00                       mvi     c, 0
231      16d6 cda717                       call    settrk    ;start with track 0
232      16d9 0e02                       mvi     c, 2      ;start reading sector 2
233      16db cdac17                       call    setsec

```

```

234 ;
235 ; read sectors, count nsects to zero
236 16de c1 pop b ;10-error count
237 16df 062c mvi b, nsects
238 rdsec: ;read next sector
239 16e1 c5 push b ;save sector count
240 16e2 cdc117 call read
241 16e5 c24917 jnz booterr ;retry if errors occur
242 16e8 2a6c18 lhld iod ;increment dma address
243 16eb 118000 lxi d, 128 ;sector size
244 16ee 19 dad d ;incremented dma address in hl
245 16ef 44 mov b, h
246 16f0 4d mov c, l ;ready for call to set dma
247 16f1 cdbb17 call setdma
248 16f4 3a6b18 lda ios ;sector number just read
249 16f7 fe1a cpi 26 ;read last sector?
250 16f9 da0517 jc rd1
251 ; must be sector 26, zero and go to next track
252 16fc 3a6a18 lda iot ;get track to register a
253 16ff 3c inr a
254 1700 4f mov c, a ;ready for call
255 1701 cda717 call settrk
256 1704 af xra a ;clear sector number
257 1705 3c rd1: inr a ;to next sector
258 1706 4f mov c, a ;ready for call
259 1707 cdac17 call setsec
260 170a c1 pop b ;recall sector count
261 170b 05 dcr b ;done?
262 170c c2e116 jnz rdsec
263 ;
264 ; done with the load, reset default buffer address
265 gocpm: ;(enter here from cold start boot)
266 ; enable rst0 and rst7

```

```

267      170f f3          di
268      1710 3e12       mvi    a, 12h        ;initialize command
269      1712 d3fd       out    revrt
270      1714 af         xra    a
271      1715 d3fc       out    intc          ;cleared
272      1717 3e7e       mvi    a, inte       ;rst0 and rst7 bits on
273      1719 d3fc       out    intc
274      171b af         xra    a
275      171c d3f3       out    icon          ;interrupt control
276
277
278      171e 018000      lxi    b, buff
279      1721 cdbb17     call   setdma
280
281
282      1724 3ec3       mvi    a, jmp
283      1726 320000     sta    0
284      1729 210316     lxi    h, wboote
285      172c 220100     shld   1             ;jump wboot at location 00
286      172f 320500     sta    5
287      1732 210608     lxi    h, bdos
288      1735 220600     shld   6             ;jmp bdos at location 5
289
290      1738 323800     sta    7*8          ;jmp to mon80 (may have changed by ddt)
291      173b 2100f8     lxi    h, mon80
292      173e 223900     shld   7*8+1
293
294
295
296      1741 3a0400     lda    cdisk         ;last logged disk number
297      1744 4f         mov    c, a          ;send to ccp to log it in
298      1745 fb         ei
299      1746 c30000     jmp    cpmb
300

```



```

301          ;          error condition occurred, print message and retry
302          booterr:
303          1749 c1          pop    b          ;recall counts
304          174a 0d          dcr    c
305          174b ca5217      jz    booter0
306          ;          try again
307          174e c5          push   b
308          174f c3c916      jmp    wboot0
309          ;
310          booter0:
311          ;          otherwise too many retries
312          1752 215b17      lxi    h, bootmsg
313          1755 cdd317      call   prmsg
314          1758 c30fff      jmp    rmon80      ;mds hardware monitor
315          ;
316          bootmsg:
317          175b 3f626f6f74  db    '?boot', 0
318          ;
319          ;
320          const:  console status to reg-a
321          ;          (exactly the same as mds call)
322          1761 c312f8      jmp    csts
323          ;
324          conin:  ;console character to reg-a
325          1764 cd03f8      call   ci
326          1767 e67f          ani    7fh          ;remove parity bit
327          1769 c9          ret
328          ;
329          conout: ;console character from c to console out
330          176a c309f8      jmp    co
331          ;
332          list:  ;list device out
333          ;          (exactly the same as mds call)
334          176d c30ff8      jmp    lo

```

```

335      ;
336      listst:
337      ;return list status
338      1770 af      xra    a
339      1771 c9      ret          ;always not ready
340      ;
341      punch:      ;punch device out
342      ;          (exactly the same as mds call)
343      1772 c30cf8 jmp    po
344      ;
345      reader:     ;reader character in to reg-a
346      ;          (exactly the same as mds call)
347      1775 c306f8 jmp    ri
348      ;
349      home:       ;move to home position
350      ;          treat as track 00 seek
351      1778 0e00    mvi    c, 0
352      177a c3a717 jmp    settrk
353      ;
354      seldsk:     ;select disk given by register c
355      177d 210000 lxi    h, 0000h ;return 0000 if error
356      1780 79      mov    a, c
357      1781 fe04    cpi    ndisks ;too large?
358      1783 d0      rnc          ;leave hl = 0000
359      ;
360      1784 e602    ani    10b ;00 00 for drive 0, 1 and 10 10 for drive 2, 3
361      1786 326618 sta    dbank ;to select drive bank
362      1789 79      mov    a, c ;00, 01, 10, 11
363      178a e601    ani    1b ;mds has 0, 1 at 78, 2, 3 at 88
364      178c b7      ora    a ;result 00?
365      178d ca9217 jz     setdrive
366      1790 3e30    mvi    a, 00110000b ;selects drive 1 in bank
367      setdrive:
368      1792 47      mov    b, a ;save the function

```

```

369      1793 216818      lxi    h, iof      ;io function
370      1796 7e         mov    a, m
371      1797 e6cf       ani    11001111b   ;mask out disk number
372      1799 b0         ora    b           ;mask in new disk number
373      179a 77         mov    m, a       ;save it in iopb
374      179b 69         mov    l, c
375      179c 2600       mvi    h, 0       ;hl=disk number
376      179e 29         dad    h           ;*2
377      179f 29         dad    h           ;*4
378      17a0 29         dad    h           ;*8
379      17a1 29         dad    h           ;*16
380      17a2 113316    lxi    d, dpbase
381      17a5 19         dad    d           ;hl=disk header table address
382      17a6 c9         ret
383      ;
384      ;
385      ;settrk:        ;set track address given by c
386      17a7 216a18    lxi    h, iot
387      17aa 71         mov    m, c
388      17ab c9         ret
389      ;
390      ;setsec:       ;set sector number given by c
391      17ac 216b18    lxi    h, ios
392      17af 71         mov    m, c
393      17b0 c9         ret
394      ;sectran:
395      ;translate sector bc using table at de
396      17b1 0600       mvi    b, 0       ;double precision sector number in bc
397      17b3 eb         xchg                    ;translate table address to hl
398      17b4 09         dad    b           ;translate (sector) address
399      17b5 7e         mov    a, m       ;translated sector number to a
400      17b6 326b18    sta    ios
401      17b9 6f         mov    l, a       ;return sector number in l
402      17ba c9         ret

```

```

403      ;
404      setdma: ;set dma address given by regs b, c
405      17bb 69      mov    l, c
406      17bc 60      mov    h, b
407      17bd 226c18  shld  iod
408      17c0 c9      ret
409      ;
410      read:  ;read next disk record (assuming disk/trk/ sec/dma set)
411      17c1 0e04      mvi   c, readf ;set to read function
412      17c3 cde017    call  setfunc
413      17c6 cdf017    call  waitio ;perform read function
414      17c9 c9      ret          ;may have error set in reg-a
415      ;
416      ;
417      write: ;disk write function
418      17ca 0e06      mvi   c, writf
419      17cc cde017    call  setfunc ;set to write function
420      17cf cdf017    call  waitio
421      17d2 c9      ret          ;may have error set
422      ;
423      ;
424      ;      utility subroutines
425      prmsg: ;print message at h, l to 0
426      17d3 7e      mov   a, m
427      17d4 b7      ora   a          zero?
428      17d5 c8      rz
429      ;      more to print
430      17d6 e5      push  h
431      17d7 4f      mov   c, a
432      17d8 cd6a17   call  conout
433      17db e1      pop   h
434      17dc 23      inx   h
435      17dd c3d317   jmp   prmsg
436      ;

```

```

437                                     setfunc:
438                                     ;
439      17e0 216818                       lxi   h, iof      ;io function address
440      17e3 7e                           mov   a, m        ;get it to accumulator for masking
441      17e4 e6f8                           ani   11111000b   ;remove previous command
442      17e6 b1                             ora   c           ;set to new command
443      17e7 77                             mov   m, a       ;replaced in iopb
444                                     ;
445                                     ; the mds-800 controller requires disk bank bit in sector byte
446                                     ; mask the bit from the current i/o function
446      17e8 e620                           ani   00100000b   ;mask the disk select bit
447      17ea 216b18                        lxi   h, ios      ;address the sector select byte
448      17ed b6                             ora   m           ;select proper disk bank
449      17ee 77                             mov   m, a       ;set disk select bit on/off
450      17ef c9                             ret
451                                     ;
452      ; waitio:
453      17f0 0e0a                           mvi   c, retry    ;max retries before perm error
454      ; rewait:
455      ; start the i/o function and wait for completion
456      17f2 cd3f18                         call  intype      ;in rtype
457      17f5 cd4c18                         call  inbyte     ;clears the controller
458      ;
459      17f8 3a6618                         lda   dbank      ;set bank flags
460      17fb b7                             ora   a          ;zero if drive 0, 1 and nz if 2, 3
461      17fc 3e67                           mvi   a, iopb and offh ;low address for iopb
462      17fe 0618                           mvi   b, iopb shr 8 ;high address for iopb
463      1800 c20b18                         jnz  iodrl      ;drive bank 1?
464      1803 d379                           out  ilow        ;low address to controller
465      1805 78                             mov  a, b
466      1806 d37a                           out  ihigh       ;high address
467      1808 c31018                         jmp  waito       ;to wait for complete
468      ;
469      ; iodrl:
470      180b d389                           out  ilow+10h    ;88 for drive bank 10

```

```

471      180d 78          mov   a, b
472      180e d38a       out   ihigh+10h
473      ;
474      1810 cd5918     waito: call  instat          ;wait for completion
475      1813 e604       ani   iordy          ;ready?
476      1815 ca1018     jz    waito
477      ;
478      ;
479      1818 cd3f18     call  intype          ;must be io complete (00) unlinked
480      ;               00 unlinked i/o complete, 01 linked i/o complete (not used)
481      ;               io disk status changed  11 (not used)
482      181b fe02       cpi   10b            ;ready status change?
483      181d ca3218     jz    wready
484      ;
485      ;               must be 00 in the accumulator
486      1820 b7         ora   a
487      1821 c23818     jnz   werror          ;some other condition, retry
488      ;
489      ;               check i/o error bits
490      1824 cd4c18     call  inbyte
491      1827 17         ral
492      1828 da3218     jc    wready          ;unit not ready
493      182b 1f         rar
494      182c e6fe       ani   11111110b      ;any other errors? (deleted data ok)
495      182e c23818     jnz   werror
496      ;
497      ;               read or write is ok, accumulator contains zero
498      1831 c9         ret
499      ;
500      wready: ;not ready, treat as error for now
501      1832 cd4c18     call  inbyte          ;clear result byte
502      1835 c33818     jmp   trycount
503      ;
504      werror: ;return hardware malfunction (crc, track, seek, etc.)

```

```

505 ; the mds controller has returned a bit in each position
506 ; of the accumulator, corresponding to the conditions:
507 ; 0 —deleted data (accepted as ok above)
508 ; 1 —crc error
509 ; 2 —seek error
510 ; 3 —address error (hardware malfunction)
511 ; 4 —data over/under flow (hardware malfunction)
512 ; 5 —write protect (treated as not ready)
513 ; 6 —write error (hardware malfunction)
514 ; j —not ready
515 ; (accumulator bits are numbered 7 6 5 4 3 2 1 0)
516 ;
517 ; it may be useful to filter out the various conditions,
518 ; but we will get a permanent error message if it is not
519 ; recoverable. In any case, the not ready condition is
520 ; treated as a separated condition for later improvement
521 ; trycount:
522 ; register c contains retry count, decrement 'til zero
523 1838 0d dcr c
524 1839 c2f217 jnz rewait ;for another try
525 ;
526 ; cannot recover from error
527 183c 3e01 mvi a, 1 ;error code
528 183e c9 ret
529 ;
530 ; intype, inbyte, instat read drive bank 00 or 10
531 183f 3a6618 intype: lda dbank
532 1842 b7 ora a
533 1843 c24918 jnz intyp1 ;skip to bank 10
534 1846 db79 in rtype
535 1848 c9 ret
536 1849 db89 intyp1: in rtype+10h ;78 for 0, 1 88 for 2, 3
537 184b c9 ret

```

```

538      ;
539      184c 3a6618      inbyte:  lda    dbank
540      184f b7          ora    a
541      1850 c25618      jnz   inbyt1
542      1853 db7b        in    rbyte
543      1855 c9          ret
544      1856 db8b        inbyt1: in    rbyte+10h
545      1858 c9          ret
546      ;
547      1859 3a6618      instat: lda   dbank
548      185c b7          ora   a
549      185d c26318      jnz   insta1
550      1860 db78        in    dstat
551      1862 c9          ret
552      1863 db88        insta1: in   dstat+10h
553      1865 c9          ret
554      ;
555      ;
556      ;
557      ;          data areas (must be in ram)
558      1866 00          dbank:  db    0          ;disk bank 00 if drive 0, 1
559      ;                  ;                  10 if drive 2, 3
560      iopb:           ;io parameter block
561      1867 80          db    80h          ;normal i/o operation
562      1868 04          iof:   db    readf        ;io function, initial read
563      1869 01          ion:   db    1          ;number of sectors to read
564      186a 02          iot:   db    offset       ;track number
565      186b 01          ios:   db    1          ;sector number
566      186c 8000        iod:   dw    buff          ;io address
567      ;
568      ;
569      ;          define ram areas for bdos operation
570      ;          endef

```



```

571      186e+=      begdat  equ    $
572      186e+      dirbuf: ds   128      ;directory access buffer
573      18ee+      alv0:   ds   31
574      190d+      csv0:   ds   16
575      191d+      alv1:   ds   31
576      193c+      csv1:   ds   16
577      194c+      alv2:   ds   31
578      196b+      csv2:   ds   16
579      197b+      alv3:   ds   31
580      199a+      csv3:   ds   16
581      19aa+=      enddat  equ    $
582      013c+=      datsiz  equ   $-begdat
583      19aa              end

```

```

als1          001f      141#
als2          001f      146#
als3          001f      151#
alv0          18ee      87      573#
alv1          191d      91      575#
alv2          194c      95      577#
alv3          197b      99      579#
base          0078      180#     181      182      183      185      186
bdos          0806      29#      287
begdat        186e      571#     582
bias          0000      19#      22#
boot          16b3      63      207#
booter0       1752      305     310#
booterr       1749      241     302#
bootmsg       175b      312     316#
buff          0080      34#     209      221      278      566
cdisk         0004      33#     213      296
ci            f803      172#    325
co            f809      174#    330

```

conin	1764	66	324#				
conout	176a	67	329#	432			
const	1761	65	320#				
cpmb	0000	28#	29	30	226	299	
cpml	1600	30#	31				
cr	000d	192#	196	205			
css1	0010	142#					
css2	0010	147#					
css3	0010	152#					
csts	f812	177#	322				
csv0	190d	87	574#				
csv1	193c	91	576#				
csv2	196b	95	578#				
csv3	199a	99	580#				
datsiz	013c	582#					
dbank	1866	361	459	531	539	547	558#
dirbuf	186e	86	90	94	98	572#	
dpb0	1673	86	101#	140	145	150	
dpb1	1673	90	140#				
dpb2	1673	94	145#				
dpb3	1673	98	150#				
dpbase	1633	83#	380				
dpe0	1633	84#					
dpe1	1643	88#					
dpe2	1653	92#					
dpe3	1663	96#					
dstat	0078	181#	550	552			
enddat	19aa	581#					
false	0000	15#	16				
gocpm	170f	214	265#				
home	1778	71	349#				
icon	00f3	166#	275				
ihigh	007a	186#	466	472			

ilow	0079	185#	464	470		
inbyt1	1856	541	544#			
inbyte	184c	457	490	501	539#	
insta1	1863	549	552#			
instat	1859	474	547#			
intc	00fc	165#	271	273		
inte	007e	167#	272			
intyp1	1849	533	536#			
intype	183f	456	479	531#		
iod	186c	242	407	566#		
iodr1	180b	463	469#			
iof	1868	369	439	562#		
ion	1869	563#				
iopb	1867	461	462	560#		
iordy	0004	191#	475			
ios	186b	248	391	400	447	565#
iot	186a	252	386	564#		
lf	000a	193#	196	196	205	
list	176d	68	332#			
listst	1770	78	336#			
lo	f80f	176#	334			
mon80	f800	170#	291			
nsects	002c	31#	237			
offset	0002	32#	100	564		
patch	1600	25#	27	28		
po	f80c	175#	343			
prmsg	17d3	211	313	425#	435	
punch	1772	69	341#			
rbyte	007b	183#	542	544		
rd1	1705	250	257#			
rdsec	16e1	238#	262			
read	17c1	76	240	410#		
reader	1775	70	345#			
readf	0004	188#	411	562		

recal	0003	190#					
retry	000a	35#	223	453			
revrt	00fd	164#	269				
rewait	17f2	454#	524				
ri	f806	173#	347				
rmon80	ff0f	171#	314				
rtype	0079	182#	534	536			
sectran	17b1	79	394#				
seldsk	177d	72	229	354#			
setdma	17bb	75	227	247	279	404#	
setdrive	1792	365	367#				
setfunc	17e0	412	419	437#			
setsec	17ac	74	233	259	390#		
settrk	17a7	73	231	255	352	385#	
signon	169c	195#	210				
test	0000	16#	18	21	197	200	289
true	ffff	14#	15				
trycount	1838	502	521#				
vers	0016	6#	204	204			
waito	1810	467	474#	476			
waitio	17f0	413	420	452#			
wboot	16c3	64	217#				
wboot0	16c9	225#	308				
wboote	1603	64#	284				
werror	1838	487	495	504#			
wready	1832	483	492	500#			
write	17ca	77	417#				
writf	0006	189#	418				
xlt0	1682	84	112#	143	148	153	
xlt1	1682	88	143#				
xlt2	1682	92	148#				
xlt3	1682	96	153#				



## Appendix B: A Skeletal CBIOS

```

1      ;      skeletal cbios for first level of cp/m 2.0 alteration
2      ;
3      0014 =   msize   equ    20           ;cp/m version memory size in kilobytes
4      ;
5      ;      "bias" is address offset from 3400h for memory systems
6      ;      than 16k (referred to as "b" throughout the text)
7      ;
8      0000 =   bias    equ    (msize-20)*1024
9      3400 =   ccp     equ    3400h+bias   ;base of ccp
10     3c06 =   bdos    equ    ccp+806h    ;base of bdos
11     4a00 =   bios    equ    ccp+1600h   ;base of bios
12     0004 =   cdisk   equ    0004h      ;current disk number 0=a, . . . , 15=p
13     0003 =   iobyte  equ    0003h      ;intel i/o byte
14     ;
15     4a00     org     bios                ;origin of this program
16     002c =   nsects  equ    ($-ccp)/128 ;warm start sector count
17     ;
18     ;      jump vector for individual subroutines
19     4a00 c39c4a   jmp     boot            ;cold start
20     4a03 c3a64a   wboote: jmp     wboot          ;warm start
21     4a06 c3114b   jmp     const          ;console status
22     4a09 c3244b   jmp     conin         ;console character in
23     4a0c c3374b   jmp     conout        ;console character out
24     4a0f c3494b   jmp     list          ;list character out
25     4a12 c34d4b   jmp     punch         ;punch character out
26     4a15 c34f4b   jmp     reader        ;reader character out
27     4a18 c3544b   jmp     home          ;move head to home position

```

```

28      4a1b c35a4b          jmp     seldsk      ;select disk
29      4a1e c37d4b          jmp     settrk      ;set track number
30      4a21 c3924b          jmp     setsec      ;set sector number
31      4a24 c3ad4b          jmp     setdma      ;set dma address
32      4a27 c3c34b          jmp     read        ;read disk
33      4a2a c3d64b          jmp     write       ;write disk
34      4a2d c34b4b          jmp     listst      ;return list status
35      4a30 c3a74b          jmp     sectran     ;sector translate
36      ;
37      ;                   fixed data tables for four-drive standard
38      ;                   ibm-compatible 8" disks
39      ;                   disk parameter header for disk 00
40      4a33 734a0000        dpbase: dw     trans, 0000h
41      4a37 00000000        dw     0000h, 0000h
42      4a3b f04c8d4a        dw     dirbf, dpblk
43      4a3f ec4d704d        dw     chk00, all00
44      ;                   disk parameter header for disk 01
45      4a43 734a0000        dw     trans, 0000h
46      4a47 00000000        dw     0000h, 0000h
47      4a4b f04c8d4a        dw     dirbf, dpblk
48      4a4f fc4d8f4d        dw     chk01, all01
49      ;                   disk parameter header for disk 02
50      4a53 734a0000        dw     trans, 0000h
51      4a57 00000000        dw     0000h, 0000h
52      4a5b f04c8d4a        dw     dirbf, dpblk
53      4a5f 0c4eae4d        dw     chk02, all02
54      ;                   disk parameter header for disk 03
55      4a63 734a0000        dw     trans, 0000h
56      4a67 00000000        dw     0000h, 0000h
57      4a6b f04c8d4a        dw     dirbf, dpblk
58      4a6f 1c4ecd4d        dw     chk03, all03
59      ;
60      ;                   sector translate vector

```

```

61      4a73 01070d13      trans:  db    1, 7, 13, 19      ;sectors 1, 2, 3, 4
62      4a77 19050b11      db    25, 5, 11, 17      ;sectors 5, 6, 7, 8
63      4a7b 1703090f      db    23, 3, 9, 15      ;sectors 9, 10, 11, 12
64      4a7f 1502080e      db    21, 2, 8, 14      ;sectors 13, 14, 15, 16
65      4a83 141a060c      db    20, 26, 6, 12     ;sectors 17, 18, 19, 20
66      4a87 1218040a      db    18, 24, 4, 10     ;sectors 21, 22, 23, 24
67      4a8b 1016          db    16, 22            ;sectors 25, 26
68
69      ;
70      4a8d 1a00          dpblk: ;disk parameter block, common to all disks
71      4a8f 03            dw    26                ;sectors per track
72      4a90 07            db    3                 ;block shift factor
73      4a91 00            db    7                 ;block mask
74      4a92 f200          dw    242               ;disk size-1
75      4a94 3f00          dw    63                ;directory max
76      4a96 c0            db    192               ;alloc 0
77      4a97 00            db    0                 ;alloc 1
78      4a98 1000          dw    16                ;check size
79      4a9a 0200          dw    2                 ;track offset
80
81      ;
82      ;
83      ;
84      ;
85      4a9c af            boot: ;simplest case is to just perform parameter initialization
86      4a9d 320300        xra   a                 ;zero in the accum
87      4aa0 320400        sta   iobyte            ;clear the iobyte
88      4aa3 c3ef4a        sta   cdisk             ;select disk zero
89      ;
90      ;
91      4aa6 318000        jmp   gocpm             ;initialize and go to cp/m
92      ;
93      4aa9 0e00          wboot: ;simplest case is to read the disk until all sectors loaded
94      4aab cd5a4b        lxi   sp, 80h           ;use space below buffer for stack
95      4aae cd544b        mvi   c, 0              ;select disk 0
96      ;
97      ;
98      ;
99      ;
100     ;

```



```

95          ;
96      4ab1 062c      mvi    b, nsects    ;b counts # of sectors to load
97      4ab3 0e00      mvi    c, 0          ;c has the current track number
98      4ab5 1602      mvi    d, 2          ;d has the next sector to read
99          ;
100         ;
101      4ab7 210034    lxi    h, ccp        ;base of cp/m (initial load point)
102         ;load1: ;load one more sector
103      4aba c5        push   b             ;save sector count, current track
104      4abb d5        push   d             ;save next sector to read
105      4abc e5        push   h             ;save dma address
106      4abd 4a        mov    c, d          ;get sector address to register c
107      4abe cd924b    call   setsec       ;set sector address from register c
108      4ac1 c1        pop    b             ;recall dma address to b, c
109      4ac2 c5        push   b             ;replace on stack for later recall
110      4ac3 cdad4b    call   setdma       ;set dma address from b, c
111         ;
112         ;
113      4ac6 cdc34b    call   read         ;drive set to 0, track set, sector set, dma address set
114      4ac9 fe00      cpi    00h          ;any errors?
115      4acb c2a64a    jnz   wboot         ;retry the entire boot if an error occurs
116         ;
117         ;
118      4ace e1        pop    h             ;no error, move to next sector
119      4acf 118000    lxi    d, 128       ;recall dma address
120      4ad2 19        dad    d             ;dma=dma+128
121      4ad3 d1        pop    d             ;new dma address is in h, l
122      4ad4 c1        pop    b             ;recall sector address
123      4ad5 05        dcr   b             ;recall number of sectors remaining, and current trk
124      4ad6 caef4a    jz    gocpm         ;sectors=sectors-1
125         ;
126         ;
127      4ad9 14        jz    gocpm         ;transfer to cp/m if all have been loaded
128         ;
129         ;
130         ;
131         ;
132         ;
133         ;
134         ;
135         ;
136         ;
137         ;
138         ;
139         ;
140         ;
141         ;
142         ;
143         ;
144         ;
145         ;
146         ;
147         ;
148         ;
149         ;
150         ;
151         ;
152         ;
153         ;
154         ;
155         ;
156         ;
157         ;
158         ;
159         ;
160         ;
161         ;
162         ;
163         ;
164         ;
165         ;
166         ;
167         ;
168         ;
169         ;
170         ;
171         ;
172         ;
173         ;
174         ;
175         ;
176         ;
177         ;
178         ;
179         ;
180         ;
181         ;
182         ;
183         ;
184         ;
185         ;
186         ;
187         ;
188         ;
189         ;
190         ;
191         ;
192         ;
193         ;
194         ;
195         ;
196         ;
197         ;
198         ;
199         ;
200         ;
201         ;
202         ;
203         ;
204         ;
205         ;
206         ;
207         ;
208         ;
209         ;
210         ;
211         ;
212         ;
213         ;
214         ;
215         ;
216         ;
217         ;
218         ;
219         ;
220         ;
221         ;
222         ;
223         ;
224         ;
225         ;
226         ;
227         ;
228         ;
229         ;
230         ;
231         ;
232         ;
233         ;
234         ;
235         ;
236         ;
237         ;
238         ;
239         ;
240         ;
241         ;
242         ;
243         ;
244         ;
245         ;
246         ;
247         ;
248         ;
249         ;
250         ;
251         ;
252         ;
253         ;
254         ;
255         ;
256         ;
257         ;
258         ;
259         ;
260         ;
261         ;
262         ;
263         ;
264         ;
265         ;
266         ;
267         ;
268         ;
269         ;
270         ;
271         ;
272         ;
273         ;
274         ;
275         ;
276         ;
277         ;
278         ;
279         ;
280         ;
281         ;
282         ;
283         ;
284         ;
285         ;
286         ;
287         ;
288         ;
289         ;
290         ;
291         ;
292         ;
293         ;
294         ;
295         ;
296         ;
297         ;
298         ;
299         ;
300         ;
301         ;
302         ;
303         ;
304         ;
305         ;
306         ;
307         ;
308         ;
309         ;
310         ;
311         ;
312         ;
313         ;
314         ;
315         ;
316         ;
317         ;
318         ;
319         ;
320         ;
321         ;
322         ;
323         ;
324         ;
325         ;
326         ;
327         ;
328         ;
329         ;
330         ;
331         ;
332         ;
333         ;
334         ;
335         ;
336         ;
337         ;
338         ;
339         ;
340         ;
341         ;
342         ;
343         ;
344         ;
345         ;
346         ;
347         ;
348         ;
349         ;
350         ;
351         ;
352         ;
353         ;
354         ;
355         ;
356         ;
357         ;
358         ;
359         ;
360         ;
361         ;
362         ;
363         ;
364         ;
365         ;
366         ;
367         ;
368         ;
369         ;
370         ;
371         ;
372         ;
373         ;
374         ;
375         ;
376         ;
377         ;
378         ;
379         ;
380         ;
381         ;
382         ;
383         ;
384         ;
385         ;
386         ;
387         ;
388         ;
389         ;
390         ;
391         ;
392         ;
393         ;
394         ;
395         ;
396         ;
397         ;
398         ;
399         ;
400         ;
401         ;
402         ;
403         ;
404         ;
405         ;
406         ;
407         ;
408         ;
409         ;
410         ;
411         ;
412         ;
413         ;
414         ;
415         ;
416         ;
417         ;
418         ;
419         ;
420         ;
421         ;
422         ;
423         ;
424         ;
425         ;
426         ;
427         ;
428         ;
429         ;
430         ;
431         ;
432         ;
433         ;
434         ;
435         ;
436         ;
437         ;
438         ;
439         ;
440         ;
441         ;
442         ;
443         ;
444         ;
445         ;
446         ;
447         ;
448         ;
449         ;
450         ;
451         ;
452         ;
453         ;
454         ;
455         ;
456         ;
457         ;
458         ;
459         ;
460         ;
461         ;
462         ;
463         ;
464         ;
465         ;
466         ;
467         ;
468         ;
469         ;
470         ;
471         ;
472         ;
473         ;
474         ;
475         ;
476         ;
477         ;
478         ;
479         ;
480         ;
481         ;
482         ;
483         ;
484         ;
485         ;
486         ;
487         ;
488         ;
489         ;
490         ;
491         ;
492         ;
493         ;
494         ;
495         ;
496         ;
497         ;
498         ;
499         ;
500         ;
501         ;
502         ;
503         ;
504         ;
505         ;
506         ;
507         ;
508         ;
509         ;
510         ;
511         ;
512         ;
513         ;
514         ;
515         ;
516         ;
517         ;
518         ;
519         ;
520         ;
521         ;
522         ;
523         ;
524         ;
525         ;
526         ;
527         ;
528         ;
529         ;
530         ;
531         ;
532         ;
533         ;
534         ;
535         ;
536         ;
537         ;
538         ;
539         ;
540         ;
541         ;
542         ;
543         ;
544         ;
545         ;
546         ;
547         ;
548         ;
549         ;
550         ;
551         ;
552         ;
553         ;
554         ;
555         ;
556         ;
557         ;
558         ;
559         ;
560         ;
561         ;
562         ;
563         ;
564         ;
565         ;
566         ;
567         ;
568         ;
569         ;
570         ;
571         ;
572         ;
573         ;
574         ;
575         ;
576         ;
577         ;
578         ;
579         ;
580         ;
581         ;
582         ;
583         ;
584         ;
585         ;
586         ;
587         ;
588         ;
589         ;
590         ;
591         ;
592         ;
593         ;
594         ;
595         ;
596         ;
597         ;
598         ;
599         ;
600         ;
601         ;
602         ;
603         ;
604         ;
605         ;
606         ;
607         ;
608         ;
609         ;
610         ;
611         ;
612         ;
613         ;
614         ;
615         ;
616         ;
617         ;
618         ;
619         ;
620         ;
621         ;
622         ;
623         ;
624         ;
625         ;
626         ;
627         ;
628         ;
629         ;
630         ;
631         ;
632         ;
633         ;
634         ;
635         ;
636         ;
637         ;
638         ;
639         ;
640         ;
641         ;
642         ;
643         ;
644         ;
645         ;
646         ;
647         ;
648         ;
649         ;
650         ;
651         ;
652         ;
653         ;
654         ;
655         ;
656         ;
657         ;
658         ;
659         ;
660         ;
661         ;
662         ;
663         ;
664         ;
665         ;
666         ;
667         ;
668         ;
669         ;
670         ;
671         ;
672         ;
673         ;
674         ;
675         ;
676         ;
677         ;
678         ;
679         ;
680         ;
681         ;
682         ;
683         ;
684         ;
685         ;
686         ;
687         ;
688         ;
689         ;
690         ;
691         ;
692         ;
693         ;
694         ;
695         ;
696         ;
697         ;
698         ;
699         ;
700         ;
701         ;
702         ;
703         ;
704         ;
705         ;
706         ;
707         ;
708         ;
709         ;
710         ;
711         ;
712         ;
713         ;
714         ;
715         ;
716         ;
717         ;
718         ;
719         ;
720         ;
721         ;
722         ;
723         ;
724         ;
725         ;
726         ;
727         ;
728         ;
729         ;
730         ;
731         ;
732         ;
733         ;
734         ;
735         ;
736         ;
737         ;
738         ;
739         ;
740         ;
741         ;
742         ;
743         ;
744         ;
745         ;
746         ;
747         ;
748         ;
749         ;
750         ;
751         ;
752         ;
753         ;
754         ;
755         ;
756         ;
757         ;
758         ;
759         ;
760         ;
761         ;
762         ;
763         ;
764         ;
765         ;
766         ;
767         ;
768         ;
769         ;
770         ;
771         ;
772         ;
773         ;
774         ;
775         ;
776         ;
777         ;
778         ;
779         ;
780         ;
781         ;
782         ;
783         ;
784         ;
785         ;
786         ;
787         ;
788         ;
789         ;
790         ;
791         ;
792         ;
793         ;
794         ;
795         ;
796         ;
797         ;
798         ;
799         ;
800         ;
801         ;
802         ;
803         ;
804         ;
805         ;
806         ;
807         ;
808         ;
809         ;
810         ;
811         ;
812         ;
813         ;
814         ;
815         ;
816         ;
817         ;
818         ;
819         ;
820         ;
821         ;
822         ;
823         ;
824         ;
825         ;
826         ;
827         ;
828         ;
829         ;
830         ;
831         ;
832         ;
833         ;
834         ;
835         ;
836         ;
837         ;
838         ;
839         ;
840         ;
841         ;
842         ;
843         ;
844         ;
845         ;
846         ;
847         ;
848         ;
849         ;
850         ;
851         ;
852         ;
853         ;
854         ;
855         ;
856         ;
857         ;
858         ;
859         ;
860         ;
861         ;
862         ;
863         ;
864         ;
865         ;
866         ;
867         ;
868         ;
869         ;
870         ;
871         ;
872         ;
873         ;
874         ;
875         ;
876         ;
877         ;
878         ;
879         ;
880         ;
881         ;
882         ;
883         ;
884         ;
885         ;
886         ;
887         ;
888         ;
889         ;
890         ;
891         ;
892         ;
893         ;
894         ;
895         ;
896         ;
897         ;
898         ;
899         ;
900         ;
901         ;
902         ;
903         ;
904         ;
905         ;
906         ;
907         ;
908         ;
909         ;
910         ;
911         ;
912         ;
913         ;
914         ;
915         ;
916         ;
917         ;
918         ;
919         ;
920         ;
921         ;
922         ;
923         ;
924         ;
925         ;
926         ;
927         ;
928         ;
929         ;
930         ;
931         ;
932         ;
933         ;
934         ;
935         ;
936         ;
937         ;
938         ;
939         ;
940         ;
941         ;
942         ;
943         ;
944         ;
945         ;
946         ;
947         ;
948         ;
949         ;
950         ;
951         ;
952         ;
953         ;
954         ;
955         ;
956         ;
957         ;
958         ;
959         ;
960         ;
961         ;
962         ;
963         ;
964         ;
965         ;
966         ;
967         ;
968         ;
969         ;
970         ;
971         ;
972         ;
973         ;
974         ;
975         ;
976         ;
977         ;
978         ;
979         ;
980         ;
981         ;
982         ;
983         ;
984         ;
985         ;
986         ;
987         ;
988         ;
989         ;
990         ;
991         ;
992         ;
993         ;
994         ;
995         ;
996         ;
997         ;
998         ;
999         ;
1000        ;

```

```

128      4ada 7a          mov   a, d          ;sector=27?, if so, change tracks
129      4adb fe1b       cpi   27
130      4add daba4a     jc    load1         ;carry generated if sector<27
131
132
133      4ae0 1601       mvi   d, 1          ;begin with first sector of next track
134      4ae2 0c         inr   c             ;track=track+1
135
136
137      4ae3 c5         push  b
138      4ae4 d5         push  d
139      4ae5 e5         push  h
140      4ae6 cd7d4b     call  settrk        ;track address set from register c
141      4ae9 e1         pop   h
142      4aea d1         pop   d
143      4aeb c1         pop   b
144      4aec c3ba4a     jmp   load1         ;for another sector
145
146
147      ;
148      ;
149      ;
150      ;
151      ;
152      ;
153      ;
154      ;
155      ;
156      ;
157      ;
158      ;
159      ;
160      ;
161      ;
162      ;
163      ;
164      ;
165      ;
166      ;
167      ;
168      ;
169      ;
170      ;
171      ;
172      ;
173      ;
174      ;
175      ;
176      ;
177      ;
178      ;
179      ;
180      ;
181      ;
182      ;
183      ;
184      ;
185      ;
186      ;
187      ;
188      ;
189      ;
190      ;
191      ;
192      ;
193      ;
194      ;
195      ;
196      ;
197      ;
198      ;
199      ;
200      ;
201      ;
202      ;
203      ;
204      ;
205      ;
206      ;
207      ;
208      ;
209      ;
210      ;
211      ;
212      ;
213      ;
214      ;
215      ;
216      ;
217      ;
218      ;
219      ;
220      ;
221      ;
222      ;
223      ;
224      ;
225      ;
226      ;
227      ;
228      ;
229      ;
230      ;
231      ;
232      ;
233      ;
234      ;
235      ;
236      ;
237      ;
238      ;
239      ;
240      ;
241      ;
242      ;
243      ;
244      ;
245      ;
246      ;
247      ;
248      ;
249      ;
250      ;
251      ;
252      ;
253      ;
254      ;
255      ;
256      ;
257      ;
258      ;
259      ;
260      ;
261      ;
262      ;
263      ;
264      ;
265      ;
266      ;
267      ;
268      ;
269      ;
270      ;
271      ;
272      ;
273      ;
274      ;
275      ;
276      ;
277      ;
278      ;
279      ;
280      ;
281      ;
282      ;
283      ;
284      ;
285      ;
286      ;
287      ;
288      ;
289      ;
290      ;
291      ;
292      ;
293      ;
294      ;
295      ;
296      ;
297      ;
298      ;
299      ;
300      ;
301      ;
302      ;
303      ;
304      ;
305      ;
306      ;
307      ;
308      ;
309      ;
310      ;
311      ;
312      ;
313      ;
314      ;
315      ;
316      ;
317      ;
318      ;
319      ;
320      ;
321      ;
322      ;
323      ;
324      ;
325      ;
326      ;
327      ;
328      ;
329      ;
330      ;
331      ;
332      ;
333      ;
334      ;
335      ;
336      ;
337      ;
338      ;
339      ;
340      ;
341      ;
342      ;
343      ;
344      ;
345      ;
346      ;
347      ;
348      ;
349      ;
350      ;
351      ;
352      ;
353      ;
354      ;
355      ;
356      ;
357      ;
358      ;
359      ;
360      ;
361      ;
362      ;
363      ;
364      ;
365      ;
366      ;
367      ;
368      ;
369      ;
370      ;
371      ;
372      ;
373      ;
374      ;
375      ;
376      ;
377      ;
378      ;
379      ;
380      ;
381      ;
382      ;
383      ;
384      ;
385      ;
386      ;
387      ;
388      ;
389      ;
390      ;
391      ;
392      ;
393      ;
394      ;
395      ;
396      ;
397      ;
398      ;
399      ;
400      ;
401      ;
402      ;
403      ;
404      ;
405      ;
406      ;
407      ;
408      ;
409      ;
410      ;
411      ;
412      ;
413      ;
414      ;
415      ;
416      ;
417      ;
418      ;
419      ;
420      ;
421      ;
422      ;
423      ;
424      ;
425      ;
426      ;
427      ;
428      ;
429      ;
430      ;
431      ;
432      ;
433      ;
434      ;
435      ;
436      ;
437      ;
438      ;
439      ;
440      ;
441      ;
442      ;
443      ;
444      ;
445      ;
446      ;
447      ;
448      ;
449      ;
450      ;
451      ;
452      ;
453      ;
454      ;
455      ;
456      ;
457      ;
458      ;
459      ;
460      ;
461      ;
462      ;
463      ;
464      ;
465      ;
466      ;
467      ;
468      ;
469      ;
470      ;
471      ;
472      ;
473      ;
474      ;
475      ;
476      ;
477      ;
478      ;
479      ;
480      ;
481      ;
482      ;
483      ;
484      ;
485      ;
486      ;
487      ;
488      ;
489      ;
490      ;
491      ;
492      ;
493      ;
494      ;
495      ;
496      ;
497      ;
498      ;
499      ;
500      ;
501      ;
502      ;
503      ;
504      ;
505      ;
506      ;
507      ;
508      ;
509      ;
510      ;
511      ;
512      ;
513      ;
514      ;
515      ;
516      ;
517      ;
518      ;
519      ;
520      ;
521      ;
522      ;
523      ;
524      ;
525      ;
526      ;
527      ;
528      ;
529      ;
530      ;
531      ;
532      ;
533      ;
534      ;
535      ;
536      ;
537      ;
538      ;
539      ;
540      ;
541      ;
542      ;
543      ;
544      ;
545      ;
546      ;
547      ;
548      ;
549      ;
550      ;
551      ;
552      ;
553      ;
554      ;
555      ;
556      ;
557      ;
558      ;
559      ;
560      ;
561      ;
562      ;
563      ;
564      ;
565      ;
566      ;
567      ;
568      ;
569      ;
570      ;
571      ;
572      ;
573      ;
574      ;
575      ;
576      ;
577      ;
578      ;
579      ;
580      ;
581      ;
582      ;
583      ;
584      ;
585      ;
586      ;
587      ;
588      ;
589      ;
590      ;
591      ;
592      ;
593      ;
594      ;
595      ;
596      ;
597      ;
598      ;
599      ;
600      ;
601      ;
602      ;
603      ;
604      ;
605      ;
606      ;
607      ;
608      ;
609      ;
610      ;
611      ;
612      ;
613      ;
614      ;
615      ;
616      ;
617      ;
618      ;
619      ;
620      ;
621      ;
622      ;
623      ;
624      ;
625      ;
626      ;
627      ;
628      ;
629      ;
630      ;
631      ;
632      ;
633      ;
634      ;
635      ;
636      ;
637      ;
638      ;
639      ;
640      ;
641      ;
642      ;
643      ;
644      ;
645      ;
646      ;
647      ;
648      ;
649      ;
650      ;
651      ;
652      ;
653      ;
654      ;
655      ;
656      ;
657      ;
658      ;
659      ;
660      ;
661      ;
662      ;
663      ;
664      ;
665      ;
666      ;
667      ;
668      ;
669      ;
670      ;
671      ;
672      ;
673      ;
674      ;
675      ;
676      ;
677      ;
678      ;
679      ;
680      ;
681      ;
682      ;
683      ;
684      ;
685      ;
686      ;
687      ;
688      ;
689      ;
690      ;
691      ;
692      ;
693      ;
694      ;
695      ;
696      ;
697      ;
698      ;
699      ;
700      ;
701      ;
702      ;
703      ;
704      ;
705      ;
706      ;
707      ;
708      ;
709      ;
710      ;
711      ;
712      ;
713      ;
714      ;
715      ;
716      ;
717      ;
718      ;
719      ;
720      ;
721      ;
722      ;
723      ;
724      ;
725      ;
726      ;
727      ;
728      ;
729      ;
730      ;
731      ;
732      ;
733      ;
734      ;
735      ;
736      ;
737      ;
738      ;
739      ;
740      ;
741      ;
742      ;
743      ;
744      ;
745      ;
746      ;
747      ;
748      ;
749      ;
750      ;
751      ;
752      ;
753      ;
754      ;
755      ;
756      ;
757      ;
758      ;
759      ;
760      ;
761      ;
762      ;
763      ;
764      ;
765      ;
766      ;
767      ;
768      ;
769      ;
770      ;
771      ;
772      ;
773      ;
774      ;
775      ;
776      ;
777      ;
778      ;
779      ;
780      ;
781      ;
782      ;
783      ;
784      ;
785      ;
786      ;
787      ;
788      ;
789      ;
790      ;
791      ;
792      ;
793      ;
794      ;
795      ;
796      ;
797      ;
798      ;
799      ;
800      ;
801      ;
802      ;
803      ;
804      ;
805      ;
806      ;
807      ;
808      ;
809      ;
810      ;
811      ;
812      ;
813      ;
814      ;
815      ;
816      ;
817      ;
818      ;
819      ;
820      ;
821      ;
822      ;
823      ;
824      ;
825      ;
826      ;
827      ;
828      ;
829      ;
830      ;
831      ;
832      ;
833      ;
834      ;
835      ;
836      ;
837      ;
838      ;
839      ;
840      ;
841      ;
842      ;
843      ;
844      ;
845      ;
846      ;
847      ;
848      ;
849      ;
850      ;
851      ;
852      ;
853      ;
854      ;
855      ;
856      ;
857      ;
858      ;
859      ;
860      ;
861      ;
862      ;
863      ;
864      ;
865      ;
866      ;
867      ;
868      ;
869      ;
870      ;
871      ;
872      ;
873      ;
874      ;
875      ;
876      ;
877      ;
878      ;
879      ;
880      ;
881      ;
882      ;
883      ;
884      ;
885      ;
886      ;
887      ;
888      ;
889      ;
890      ;
891      ;
892      ;
893      ;
894      ;
895      ;
896      ;
897      ;
898      ;
899      ;
900      ;
901      ;
902      ;
903      ;
904      ;
905      ;
906      ;
907      ;
908      ;
909      ;
910      ;
911      ;
912      ;
913      ;
914      ;
915      ;
916      ;
917      ;
918      ;
919      ;
920      ;
921      ;
922      ;
923      ;
924      ;
925      ;
926      ;
927      ;
928      ;
929      ;
930      ;
931      ;
932      ;
933      ;
934      ;
935      ;
936      ;
937      ;
938      ;
939      ;
940      ;
941      ;
942      ;
943      ;
944      ;
945      ;
946      ;
947      ;
948      ;
949      ;
950      ;
951      ;
952      ;
953      ;
954      ;
955      ;
956      ;
957      ;
958      ;
959      ;
960      ;
961      ;
962      ;
963      ;
964      ;
965      ;
966      ;
967      ;
968      ;
969      ;
970      ;
971      ;
972      ;
973      ;
974      ;
975      ;
976      ;
977      ;
978      ;
979      ;
980      ;
981      ;
982      ;
983      ;
984      ;
985      ;
986      ;
987      ;
988      ;
989      ;
990      ;
991      ;
992      ;
993      ;
994      ;
995      ;
996      ;
997      ;
998      ;
999      ;
1000     ;

```

```

161      4b0a 3a0400      lda    cdisk    ;get current disk number
162      4b0d 4f          mov    c, a     ;send to the ccp
163      4b0e c30034      jmp    ccp      ;go to cp/m for further processing
164      ;
165      ;
166      ;          simple i/o handlers (must be filled in by user)
167      ;          in each case, the entry point is provided, with space reserved
168      ;          to insert your own code
169      ;
170      const:          ;console status, return 0ffh if character ready, 00h if not
171      4b11              ds     10h      ;space for status subroutine
172      4b21 3e00        mvi    a, 00h
173      4b23 c9          ret
174      ;
175      conin:          ;console character into register a
176      4b24              ds     10h      ;space for input routine
177      4b34 e67f        ani    7fh     ;strip parity bit
178      4b36 c9          ret
179      ;
180      conout:         ;console character output from register c
181      4b37 79          mov    a, c     ;get to accumulator
182      4b38              ds     10h      ;space for output routine
183      4b48 c9          ret
184      ;
185      list:           ;list character from register c
186      4b49 79          mov    a, c     ;character to register a
187      4b4a c9          ret            ;null subroutine
188      ;
189      listst:         ;return list status (0 if not ready, 1 if ready)
190      4b4b af          xra    a       ;0 is always ok to return
191      4b4c c9          ret
192      ;
193      punch:          ;punch character from register c

```

```

194      4b4d 79          mov   a, c      ;character to register a
195      4b4e c9          ret              ;null subroutine
196      ;
197      ;
198      reader:         ;read character into register a from reader device
199      4b4f 3e1a        mvi   a, 1ah    ;enter end of file for now (replace later)
200      4b51 e67f        ani   7fh       ;remember to strip parity bit
201      4b53 c9          ret
202      ;
203      ;
204      ;               i/o drivers for the disk follow
205      ;               for now, we will simply store the parameters away for use
206      ;               in the read and write subroutines
207      ;
208      home:           ;move to the track 00 position of current drive
209      ;               translate this call into a settrk call with parameter 00
210      4b54 0e00        mvi   c, 0      ;select track 0
211      4b56 cd7d4b      call  settrk
212      4b59 c9          ret              ;we will move to 00 on first read/write
213      ;
214      seldsk:         ;select disk given by register c
215      4b5a 210000      lxi   h, 0000h  ;error return code
216      4b5d 79          mov   a,c
217      4b5e 32ef4c      sta   diskno
218      4b61 fe04        cpi   4          ;must be between 0 and 3
219      4b63 d0          rnc              ;no carry if 4, 5, . . .
220      ;               disk number is in the proper range
221      4b64             ds    10          ;space for disk select
222      ;               compute proper disk parameter header address
223      4b6e 3aef4c      lda   diskno
224      4b71 6f          mov   l, a      ;l=disk number 0, 1, 2, 3
225      4b72 2600        mvi   h, 0      ;high order zero
226      4b74 29          dad   h          ;*2

```

```

227      4b75 29          dad    h          ;*4
228      4b76 29          dad    h          ;*8
229      4b77 29          dad    h          ;*16 (size of each header)
230      4b78 11334a      lxi    d, dpbase
231      4b7b 19          dad    0          ;hl=.dpbase(diskno*16)
232      4b7c c9          ret
233
234      ;
234      settrk:          ;set track given by register c
235      4b7d 79          mov    a, c
236      4b7e 32e94c      sta    track
237      4b81              ds    10h          ;space for track select
238      4b91 c9          ret
239
240      ;
240      setsec:          ;set sector given by register c
241      4b92 79          mov    a, c
242      4b93 32eb4c      sta    sector
243      4b96              ds    10h          ;space for sector select
244      4ba6 c9          ret
245
246      ;
246      sectran:
247      ;translate the sector given by bc using the
248      ;translate table given by de
249      4ba7 eb          xchg          ;hl=.trans
250      4ba8 09          dad    b          ;hl=.trans(sector)
251      4ba9 6e          mov    l, m       ;l = trans(sector)
252      4baa 2600        mvi    h, 0       ;hl = trans(sector)
253      4bac c9          ret              ;with value in hl
254
255      ;
255      setdma:          ;set dma address given by registers b and c
256      4bad 69          mov    l, c       ;low order address
257      4bae 60          mov    h, b       ;high order address
258      4baf 22ed4c      shld   dmaad      ;save the address
259      4bb2              ds    10h          ;space for setting the dma address

```

```

260      4bc2 c9          ;          ret
261          ;
262          read:      ;perform read operation (usually this is similar to write
263          ;          so we will allow space to set up read command, then use
264          ;          common code in write)
265      4bc3          ds      10h          ;set up read command
266      4bd3 c3e64b    jmp      waitio      ;to perform the actual i/o
267          ;
268          write:     ;perform a write operation
269      4bd6          ds      10h          ;set up write command
270          ;
271          waitio:    ;enter here from read and write to perform the actual i/o
272          ;          operation. return a 00h in register a if the operation completes
273          ;          properly, and 01h if an error occurs during the read or write
274          ;
275          ;          in this case, we have saved the disk number in 'diskno' (0, 1)
276          ;          the track number in 'track' (0-76)
277          ;          the sector number in 'sector' (1-26)
278          ;          the dma address in 'dmaad' (0-65535)
279      4be6          ds      256         ;space reserved for i/o drivers
280      4ce6 3e01      mvi      a, 1         ;error condition
281      4ce8 c9          ret          ;replaced when filled- in
282          ;
283          ;          the remainder of the cbios is reserved uninitialized
284          ;          data area, and does not need to be a part of the
285          ;          system memory image (the space must be available,
286          ;          however, between "begdat" and "enddat").
287          ;
288      4ce9          track:   ds      2          ;two bytes for expansion
289      4ceb          sector:  ds      2          ;two bytes for expansion
290      4ced          dmaad:  ds      2          ;direct memory address

```

```

291      4cef          diskno: ds    1          ;disk number 0-15
292          ;
293          ;          scratch ram area for bdos use
294      4cf0 =      begdat  equ    $          ;beginning of data area
295      4cf0          dirbf:  ds    128        ;scratch directory area
296      4d70          all00:  ds    31        ;allocation vector 0
297      4d8f          all01:  ds    31        ;allocation vector 1
298      4dae          all02:  ds    31        ;allocation vector 2
299      4dcd          all03:  ds    31        ;allocation vector 3
300      4dec          chk00:  ds    16        ;check vector 0
301      4dfc          chk01:  ds    16        ;check vector 1
302      4e0c          chk02:  ds    16        ;check vector 2
303      4e1c          chk03:  ds    16        ;check vector 3
304          ;
305      4e2c          enddat  equ    $          ;end of data area
306      013c =      datsiz  equ    $-begdat; ;size of data area
307      4e2c          end

```

```

all00      4d70      43      296#
all01      4d8f      48      297#
all02      4dae      53      298#
all03      4dcd      58      299#
bdos       3c06      10#     154
begdat     4cf0      294#    306
bias       0000      8#      9
bios       4a00      11#     15
boot       4a9c      19      84#
ccp        3400      9#      10      11      16      101      163
cdisk      0004      12#     87      161
chk00      4dec      43      300#
chk01      4dfc      48      301#
chk02      4e0c      53      302#
chk03      4e1c      58      303#

```

conin	4b24	22	175#			
conout	4b37	23	180#			
const	4b11	21	170#			
datsiz	013c	306#				
dirbf	4cf0	42	47	52	57	295#
diskno	4cef	217	223	291#		
dmaad	4ced	258	290#			
dpbase	4a33	40#	230			
dpblk	4a8d	42	47	52	57	69#
enddat	4e2c	305#				
gocpm	4aef	88	124	147#		
home	4b54	27	94	208#		
iobyte	0003	13#	86			
list	4b49	24	185#			
listst	4b4b	34	189#			
load1	4aba	102#	130	144		
msize	0014	3#	8			
nsects	002c	16#	96			
punch	4b4d	25	193#			
read	4bc3	32	113	262#		
reader	4b4f	26	198#			
sector	4ceb	242	289#			
sectran	4ba7	35	246#			
seldsk	4b5a	28	93	214#		
setdma	4bad	31	110	158	255#	
setsec	4b92	30	107	240#		
settrk	4b7d	29	140	211	234#	
track	4ce9	236	288#			
trans	4a73	40	45	50	55	61#
waitio	4be6	266	271#			
wboot	4aa6	20	90#	115		
wboote	4a03	20#	150			
write	4bd6	33	268#			





## Appendix C: A Skeletal GETSYS/PUTSYS Program

```

;      combined getsys and putsys programs from
;      Sec 6.4
;      Start the programs at the base of the TPA

0100          org 0100h

0014 =      msize    equ 20          ; size of cp/m in Kbytes

; "bias" is the amount to add to addresses for > 20k
;          (referred to as "b" throughout the text)

0000 =      bias     equ (msize-20)*1024
3400 =      ccp      equ 3400h+bias
3c00 =      bdos     equ ccp+0800h
4a00 =      bios     equ ccp+1600h

;      getsys programs tracks 0 and 1 to memory at
;      3880h + bias

;      register          usage
;      a                (scratch register)
;      b                track count (0...76)
;      c                sector count (1...26)
;      d,e             (scratch register pair)
;      h,l             load address
;      sp              set to track address

gstart:
0100 318033    lxi    sp,ccp-0080h    ; start of getsys
0103 218033    lxi    h,ccp-0080h    ; convenient place
0106 0600     mvi    b,0          ; set initial load
; start with track
rd$trk:      ; read next track

```

```

0108 0e01                mvi  c,1          ; each track start
rd$sec:
010a cd0003             call read$sec     ; get the next sector
010d 118000             lxi  d,128       ; offset by one sector
0110 19                 dad  d           ; (hl=hl+128)
0111 0c                 inr  c           ; next sector
0112 79                 mov  a,c         ; fetch sector number
0113 felb               cpi  27         ; and see if last
0115 da0a01             jc   rdsec       ; <, do one more

; arrive here at end of track, move to next track

0118 04                 inr  b           ; track = track+1
0119 78                 mov  a,b         ; check for last
011a fe02               cpi  2           ; track = 2 ?
011c da0801             jc   rd$trk     ; <, do another

; arrive here at end of load, halt for lack of anything
; better

011f fb                 ei
0120 76                 hlt
;
; putsys program, places memory image
; starting at
;
; 3880h + bias back to tracks 0 and 1
;
; start this program at the next page boundary
0200                    org  ($+0100h) and 0ff00h

put$sys:
0200 318033             lxi  sp,ccp-0080h ; convenient place
0203 218033             lxi  h,ccp-0080h ; start of dump
0206 0600               mvi  b,0         ; start with track

wr$trk:
0208 0e01             mvi  c,1         ; start with sector

wr$sec:
020a cd0004             call write$sec    ; write one sector
020d 118000             lxi  d,128       ; length of each
0210 19                 dad  d           ; <hl>=<hl> + 128
0211 0c                 inr  c           ; <c>=<c> + 1
0212 79                 mov  a,c         ; see if
0213 felb               cpi  27         ; past end of track
0215 da0a02             jc   wr$sec     ; no, do another

; arrive here at end of track, move to next track

0218 04                 inr  b           ; track = track+1
0219 78                 mov  a,b         ; see if
021a fe02               cpi  2           ; last track
021c da0802             jc   wr$trk     ; no, do another

;
; done with putsys, halt for lack of anything
; better

021f fb                 ei
0220 76                 hlt

```

```

; user supplied subroutines for sector read and write

;         move to next page boundary

0300         org  ($+0100h) and 0ff00h

read$sec:
; read the next sector
; track in <b>,
; sector in <c>
; dmaaddr in <h>

0300 c5         pushb
0301 e5         pushh

; user defined read operation goes here
0302         ds  64

0342 e1         pop  h
0343 c1         pop  b
0344 c9         ret

0400         org  ($+0100h) and 0ff00h ;another page
; boundary

write$sec:
; same parameters as read$sec

0400 c5         pushb
0401 e5         pushh

; user defined write operation goes here
0402         ds  64

0442 e1         pop  h
0443 c1         pop  b
0444 c9         ret

; end of getsys/putsys program

0445         end

```



## Appendix D: The MDS-800 Cold Start Loader for CP/M 2

```

1          title   mds cold start loader at 3000h'
2          ;
3          ;       mds-800 cold start loader for cp/m 2.0
4          ;
5          ;       version 2.0 august, 1979
6          ;
7          0000 =   false   equ   0
8          ffff    true    equ   not false
9          0000 =   testing  equ   false   if true, then go to mon80 on errors
10         ;
11         ;       if      testing
12         bias    equ     03400h
13         ;       endif
14         ;       if      not testing
15         0000 =   bias     equ     0000h
16         ;       endif
17         0000 =   cpmb     equ     bias       ;base of dos load
18         0806 =   bdos     equ     806h+bias  ;entry to dos for calls
19         1880 =   bdose    equ     1880h+bias ;end of dos load
20         1600 =   boot     equ     1600h+bias ;cold start entry point
21         1603 =   rboot    equ     boot+3    ;warm start entry point
22         ;
23         3000     org     03000h       ;loaded down from hardware boot at 3000H
24         ;
25         1880 =   bdosl    equ     bdose-cpmb
26         0002 =   ntrks    equ     2         ;number of tracks to read
27         0031 =   bdoss    equ     bdosl/128  ;number of sectors in dos
28         0019 =   bdoso    equ     25        ;number of bdos sectors on track 0
29         0018 =   bdos1    equ     bdoss-bdoso ;number of sectors on track 1

```

```

30      ;
31      f800 =      mon80 equ    of800h ;intel monitor base
32      ffof =      rmon80 equ    offofh ;restart location for mon80
33      0078 =      base   equ    078h  ;'base' used by controller
34      0079 =      rtype  equ    base+1 ;result type
35      007b =      rbyte  equ    base+3 ;result byte
36      007f =      reset  equ    base+7 ;reset controller
37      ;
38      0078 =      dstat  equ    base   ;disk status port
39      0079 =      ilow   equ    base+1 ;low iopb address
40      007a =      ihigh  equ    base+2 ;high iopb address
41      00ff =      bsw    equ    offh   ;boot switch
42      0003 =      recal  equ    3h     ;recalibrate selected drive
43      0004 =      readf  equ    4h     ;disk read function
44      0100 =      stack  equ    100h   ;use end of boot for stack
45      ;
46      rstart:
47      3000 310001      lxi    sp,stack; ;in case of call to mon80
48      ;                clear disk status
49      3003 db79        in     rtype
50      3005 db7b        in     rbyte
51      ;                check if boot switch is off
52      coldstart:
53      3007 dbff        in     bsw
54      3009 e602        ani    02h     ;switch on?
55      300b c20730      jnz    coldstart
56      ;                clear the controller
57      300e d37f        out    reset   ;logic cleared
58      ;
59      ;
60      3010 0602        mvi    b,ntrks ;number of tracks to read
61      3012 214230      lxi    h,iopbo
62      ;

```

```

63          start:
64          ;
65          ;      read first/next track into cpmb
66          3015 7d      mov    a,l
67          3016 d379    out    ilow
68          3018 7c      mov    a,h
69          3019 d37a    out    ihigh
70          301b db78    waito:  in    dstat
71          301d e604    ani    4
72          301f ca1b30  jz     waito
73          ;
74          ;      check disk status
75          3022 db79    in     rtype
76          3024 e603    ani    11b
77          3026 fe02    cpi    2
78          ;
79          ;      if testing
80          3028 d20030  cnc   rmon80 ;go to monitor if 11 or 10
81          ;      endif
82          ;      if not testing
83          ;      jnc rstart ;retry the load
84          ;      endif
85          ;
86          302b db7b    in     rbyte ;i/o complete, check status
87          ;      if not ready, then go to mon80
88          302d 17      ral
89          302e dc0fff  cc    rmon80 ;not ready bit set
90          3031 1f      rar    ;restore
91          3032 e61e    ani    11110b ;overrun/addr err/seek/crc/xxxx
92          ;
93          ;      if testing
94          ;      cnz rmon80 ;go to monitor
95          ;      endif
96          ;      if not testing

```



```

97      3034 c20030      jnz  rstart  ;retry the load
98      ;
99      ;
100     ;
101     3037 110700      lxi  d,iopbl ;length of iopb
102     303a 19          dad  d       ;addressing next iopb
103     303b 05          dcr  b       ;count down tracks
104     303c c21530      jnz  start
105     ;
106     ;
107     ;
108     303f c30016      jmp  boot    ;jmp to boot to print initial message, and set up jmps
109     ;
110     ;
111     3042 80          iopbo: db  80h  ;iocw, no update
112     3043 04          db  readf  ;read function
113     3044 19          db  bdoso  ;# sectors to read on track 0
114     3045 00          db  0      ;track 0
115     3046 02          db  2      ;start with sector 2 on track 0
116     3047 0000       dw  cpmb   ;start at base of bdos
117     0007 =          iopbl equ  $-iopbo
118     ;
119     3049 80          iopb1: db  80h
120     304a 04          db  readf
121     304b 18          db  bdos1  ;sectors to read on track 1
122     304c 01          db  1      ;track 1
123     304d 01          db  1      ;sector 1
124     304e 800c       dw  cmpb+bdos0*128 ;base of second read
125     ;
126     3050            end

```

base	0078	33#	34	35	36	38	39	40
bdos	0806	18#						
bdoso	0019	28#	29	113	124			
bdos1	0018	29#	121					
bdose	1880	19#	25					
bdosl	1880	25#	27					
bdoss	0031	27#	29					
bias	0000	12#	15#	17	18	19	20	
boot	1600	20#	21	108				
bsw	00ff	41#	53					
coldstart	3007	52#	55					
cpmb	0000	17#	25	116	124			
dstat	0078	38#	70					
false	0000	7#	8	9				
ihigh	007a	40#	69					
ilow	0079	39#	67					
iopbo	3042	61	111#	117				
iopb1	3049	119#						
iopbl	0007	101	117#					
mon80	f800	31#						
ntrks	0002	26#	60					
rboot	1603	21#						
rbyte	007b	35#	50	86				
readf	0004	43#	112	120				
recal	0003	42#						
reset	007f	36#	57					
rmon80	ff0f	32#	80	89	94			
rstart	3000	46#	83	97				
rtype	0079	34#	49	75				
stack	0100	44#	47					
start	3015	63#	104					
testing	0000	9#	11	14	79	82	93	96
true	ffff	8#						
waito	301b	70#	72					



## Appendix E: A Skeletal Cold Start Loader

```

; this is a sample cold start loader, which, when
; modified
; resides on track 00, sector 01 (the first sector on the
; diskette). we assume that the controller has loaded
; this sector into memory upon system start-up (this
; program can be keyed-in, or can exist in read/only
; memory
; beyond the address space of the cp/m version you are
; running). the cold start loader brings the cp/m system
; into memory at "loadp" (3400h + "bias"). in a 20k
; memory system, the value of "bias" is 0000h, with
; large
; values for increased memory sizes (see section 2).
; after
; loading the cp/m system, the cold start loader
; branches
; to the "boot" entry point of the bios, which begins at
; "bios" + "bias." the cold start loader is not used un-
; til the system is powered up again, as long as the bios
; is not overwritten. the origin is assumed at 0000h, an
; must be changed if the controller brings the cold start
; loader into another area, or if a read/only memory
; area
; is used.

0000                                org 0                                ; base of ram in
; cp/m

0014 =                               msize   equ 20                        ; min mem size in
; kbytes
```

```

0000 =          bias      equ (msize-20)*1024    ; offset from 20k
                                           ; system
3400 =          ccp       equ 3400h+bias        ; base of the ccp
4a00 =          bios      equ ccp+1600h        ; base of the bios
0300 =          biosl     equ 0300h            ; length of the bios
4a00 =          boot      equ bios              ;
1900 =          size      equ bios+biosl-ccp    ; size of cp/m
                                           ; system
0032 =          sects     equ size/128         ; # of sectors to load

;          begin the load operation

cold:
0000 010200     lxi  b,2                        ; b=0, c=sector 2
0003 1632       mvi  d,sects                    ; d=# sectors to
                                           ; load
0005 210034     lxi  h,ccp                      ; base transfer
                                           ; address

lsect:          ; load the next sector

;          insert inline code at this point to
;          read one 128 byte sector from the
;          track given in register b, sector
;          given in register c,
;          into the address given by <hl>
; branch to location "cold" if a read error occurs
;
;
;          user supplied read operation goes
;          here...
;
;
0008 c36b00     jmp  past$patch                    ; remove this
                                           ; when patched
000b           ds    60h

past$patch:
; go to next sector if load is incomplete
006b 15        dcr  d                          ; sects=sects-1
006c ca004a    jz   boot                      ; head for the bios

;          more sectors to load
;
; we aren't using a stack, so use <sp> as scratch
; register
;          to hold the load address increment

006f 318000     lxi  sp,128                    ; 128 bytes per
                                           ; sector
0072 39        dad  sp                        ; <hl> = <hl> +
                                           128

```

```

0073 0c          inr  c          ; sector = sector + 1
0074 79          mov  a,c
0075 fe1b        cpi  27         ; last sector of
                                ; track?
0077 da0800     jc   lsect      ; no, go read
                                ; another

                                ; end of track, increment to next track

007a 0e01        mvi  c,l        ; sector = 1
007c 04          inr  b          ; track = track + 1
007d c30800     jmp  lsect      ; for another group
0080            end          ; of boot loader

```



## Appendix F: CP/M Disk Definition Library

```
1: ;          CP/M 2.0 disk re-definition library
2: ;
3: ;          Copyright © 1979
4: ;          Digital Research
5: ;          Box 579
6: ;          Pacific Grove, CA
7: ;          93950
8: ;
9: ;          CP/M logical disk drives are defined using the
10: ;         macros given below, where the sequence of calls
11: ;         is:
12: ;
13: ;         disks  n
14: ;         diskdef parameter-list-0
15: ;         diskdef parameter-list-1
16: ;         ...
17: ;         diskdef parameter-list-n
18: ;         endef
19: ;
20: ;         where n is the number of logical disk drives attached
21: ;         to the CP/M system, and parameter-list-i defines the
22: ;         characteristics of the ith drive (i=0,1,...,n-1)
23: ;
24: ;         each parameter-list-i takes the form
25: ;         dn,fsc,lsc,[skf],bls,dks,dir,cks,ofs,[0]
26: ;         where
27: ;         dn      is the disk number 0,1,...,n-1
28: ;         fsc     is the first sector number (usually 0 or 1)
29: ;         lsc     is the last sector number on a track
30: ;         skf     is optional "skew factor" for sector translate
31: ;         bls     is the data block size (1024,2048,...,16384)
```



```

32: ;          dks      is the disk size in bls increments (word)
33: ;          dir      is the number of directory elements (word)
34: ;          cks      is the number of dir elements to checksum
35: ;          ofs      is the number of tracks to skip (word)
36: ;          [0]      is an optional 0 which forces 16K/directory end
37: ;
38: ;          for convenience, the form
39: ;              dn,dm
40: ;          defines disk dn as having the same characteristics as
41: ;          a previously defined disk dm.
42: ;
43: ;          a standard four drive CP/M system is defined by
44: ;              disks          4
45: ;              diskdef       0,1,26,6,1024,243,64,64,2
46: ;          dsk      set          0
47: ;              rept         3
48: ;          dsk      set          dsk+1
49: ;              diskdef      %dsk,0
50: ;              endm
51: ;              endef
52: ;
53: ;          the value of "begdat" at the end of assembly defines the
54: ;          beginning of the uninitialized ram area above the bios,
55: ;          while the value of "enddat" defines the next location
56: ;          following the end of the data area. the size of this
57: ;          area is given by the value of "datsiz" at the end of the
58: ;          assembly. note that the allocation vector will be quite
59: ;          large if a large disk size is defined with a small block
60: ;          size.
61: ;
62: dskhdr      macro    dn
63: ;;          define a single disk header list
64: dpe&dn:     dw      xlt&dn,0000h      ;translate table

```

```

65:          dw      0000h,0000h      ;scratch area
66:          dw      dirbuf,dpb&dn    ;dir buff,param block
67:          dw      csv&dn,alv&dn    ;check, alloc vectors
68:          endm
69: ;
70: disks          macro   nd
71: ;;            define nd disks
72: ndisks        set     nd          ;; for later reference
73: dpbase       equ     $           ;base of disk parameter blocks
74: ;;            generate the nd elements
75: dsknxt       set     0
76:              rept    nd
77:              dskhdr  %dsknxt
78: dsknxt       set     dsknxc+1
79:              endm
80:              endm
81: ;
82: dpbhdr        macro   dn
83: dpb&dn       equ     $           ;disk parm block
84:              endm
85: ;
86: ddb          macro   data,comment
87: ;;            define a db statement
88:              db      data         comment
89:              endm
90: ;
91: ddw          macro   data,comment
92: ;;            define a dw statement
93:              dw      data         comment
94:              endm
95: ;
96: gcd          macro   m,n
97: ;;            greatest common divisor of m,n
98: ;;            produces value gcdn as result

```

```

99: ;;                                (used in sector translate table generation)
100: gcdm                             set      m                ;;variable for m
101: gcdn                             set      n                ;;variable for n
102: gcdr                             set      0                ;;variable for r
103:                                 rept    65535
104: gcdx                             set      gcdm/gcdn
105: gcdr                             set      gcdm-gcdx*gcdn
106:                                 if      gcdr = 0
107:                                 exitm
108:                                 endif
109: gcdm                             set      gcdn
110: gcdn                             set      gcdr
111:                                 endm
112:                                 endm
113: ;
114: diskdef                          macro   dn,fsc,lsc,skf,bls,dks,dir,cks,ofs,k16
115: ;;                                generate the set statements for later tables
116:                                 if      nul lsc
117: ;;                                current disk dn                same as previous fsc
118: dpb&dn                            equ     dpb&fsc          ;;equivalent parameters
119: als&dn                            equ     als&fsc          ;;same allocation vector size
120: css&dn                            equ     css&fsc          ;;same checksum vector size
121: xlt&dn                            equ     xlt&fsc          ;;same translate table
122:                                 else
123: secmax                             set     lsc-(fsc)        ;;sectors 0...secmax
124: sectors                            set     secmax+1        ;;number of sectors
125: als&dn                            set     (dks)/8         ;;size of allocation vector
126:                                 if      ((dks) mod 8) ne 0
127: als&dn                            set     als&dn+1
128:                                 endif
129: css&dn                            set     (cks)/4         ;;number of checksum elements
130: ;;                                generate the block shift value
131: blkval                             set     bls/128         ;;number of sectors/ block

```

```

132: blkshf          set      0          ;;counts right 0's in blkval
133: blkmsk         set      0          ;;fills with l's from right
134:               rept    16          ;;once for each bit position
135:               if      blkval=1
136:               exitm
137:               endif
138: ;;              otherwise, high order 1 not found yet
139: blkshf          set      blkshf+1
140: blkmsk         set      (blkmsk shl l) or l
141: blkval         set      blkval/2
142:               endm
143: ;;              generate the extent mask byte
144: blkval         set      bls/1024      ;;number of kilobytes/ block
145: extmsk         set      0          ;;fill from right with l's
146:               rept    16
147:               if      blkval=1
148:               exitm
149:               endif
150: ;;              otherwise more to shift
151: extmsk         set      (extmsk shl l) or l
152: blkval         set      blkval/2
153:               endm
154: ;;              may be double byte allocation
155:               if      (dks) > 256
156: extmsk         set      (extmsk shr l)
157:               endif
158: ;;              may be optional [0] in last position
159:               if      not nul k16
160: extmsk         set      k16
161:               endif
162: ;;              now generate directory reservation bit vector
163: dirrem         set      dir          ;;# remaining to process
164: dirbks         set      bls/32      ;;number of entries per block
165: dirblk         set      0          ;;fill with l's on each loop
166:               rept    16
167:               if      dirrem=0
168:               exitm
169:               endif

```

```

170: ;;          not complete, iterate once again
171: ;;          shift right and add 1 high order bit
172: dirblk      set      (dirblk shr l) or 8000h
173:             if      dirrem > dirbks
174: dirrem      set      dirrem-dirbks
175:             else
176: direem      set      0
177:             endif
178:             endm
179: dpbhdr      dn          ;;generate equ $
180: ddw        %sectors,<;sec per track>
181: ddb        %blkshf,<;block shift>
182: ddb        %blkmsk,<;block mask>
183: ddb        %extmsk,<;extnt mask>
184: ddw        %(&dks)-1,<;disk size-1>
185: ddw        %(&dir)-1,<;directory max>
186: ddb        %dirblk shr 8,<;alloc0>
187: ddb        %dirblk and 0ffh,<;alloc1>
188: ddw        %(&cks)/4,<;check size>
189: ddw        %ofs,<;offset>
190: ;;          generate the translate table, if requested
191:             if      nul skf
192: xlt&dn      equ      0          ;no xlate table
193:             else
194:             if      skf = 0
195: xlt&dn      equ      0          ;no xlate table
196:             else
197: ;;          generate the translate table
198:             set      0          ;;next sector to fill
199:             set      0          ;;moves by one on overflow
200:             gcd      %sectors,skf
201: ;;          gcdn = gcd(sectors,skew)
202:             set      sectors/gcdn
203: ;;          neltst is number of elements to generate

```

```

204: ;;
205: nelts      set      nelts          ;;counter
206: xlt&dn     equ      $              ;translate table
207:           rept      sectors        ;once for each sector
208:           if        sectors < 256
209:           ddb      %nxtsec+(fsc)
210:           else
211:           ddw      %nxtsec+(fsc)
212:           endif
213: nxtsec      set      nxtsec+(skf)
214:           if        nxtsec >= sectors
215:           set      nxtsec-sectors
216:           endif
217: nelts      set      nelts-1
218:           if        nelts = 0
219:           set      nxtbas+1
220:           set      nxtbas
221:           set      nelts
222:           endif
223:           endm
224:           endif      ;;end of nul fac test
225:           endif      ;;end of nul bls test
226:           endm
227: ;
228: defds      macro    lab,space
229: lab:       ds      space
230:           endm
231: ;
232: lds      macro    lb,dn,val
233: defds    lb&dn,%val&dn
234:           endm
235: ;
236: endef      macro
237: ;;          generate the necessary ram data areas

```

```
238: begdat      equ      $
239: dirbuf:     ds       128          ;directory access buffer
240: dsknxt      set      0
241:             rept    ndisks        ;;once for each disk
242:             lds     alv,%dsknxt,als
243:             lds     csv,%dsknxt,ccs
244: dsknxt      set      dsknxt+1
245:             endm
246: enddat      equ      $
247: datsiz      equ      $-begdat
248: ;;         db 0 at this point forces hex record
249:             endm
```

## Appendix G: Blocking and Deblocking Algorithms

```

1      ;
2      ;
3      ;      sector deblocking algorithms for cp/m 2.0
4      ;
5      ;
6      ;
7      ;      utility macro to compute sector mask
8      smask macro   hblk
9      ;;      compute log2(hblk), return @x as result
10     ;;      (2 ** @x = hblk on return)
11     @y      set    hblk
12     @x      set    0
13     ;;      count right shifts of @y until = 1
14     rept    8
15     if      @y = 1
16     exitm
17     endif
18     ;;      @y is not 1, shift right one position
19     @y      set    @y shr 1
20     @x      set    @x + 1
21     endm
22     endm
23     ;
24     ;
25     ;
26     ;      cp/m to host disk constants
27     ;
28     ;
29     0800 =   blksiz   equ    2048           ;cp/m allocation size
30     0200 =   hstsiz   equ    512           ;host disk sector size
31     0014 =   hstspt   equ    20           ;host disk sectors/trk
32     0004 =   hstblk   equ    hstsiz/128   ;cp/m sects/host buff
33     0050 =   cpmspt   equ    hstblk * hstspt ;cp/m sectors/track

```



```

34      0003 =   secmsk   equ    hstblk-1      ;sector mask
35                smask   hstblk      ;compute sector mask
36      0002 =   secshf   equ    @x          ;log2(hstblk)
37                ;
38                ;
39                ;
40                ;      bdos constants on entry to write
41                ;
42                ;
43      0000 =   wrall    equ    0          ;write to allocated
44      0001 =   wrdir    equ    1          ;write to directory
45      0002 =   wrual    equ    2          ;write to unallocated
46                ;
47                ;
48                ;
49                ;      the bdos entry points given below show the
50                ;      code which is relevant to deblocking only.
51                ;
52                ;
53                ;
54                ;      diskdef macro, or hand coded tables go here
55      0000 =   dpbase   equ    $          ;disk param block base
56                ;
57      boot:
58      wboot:
59                ;enter here on system boot to initialize
60      0000 af      xra    a              ;0 to accumulator
61      0001 326a01  sta    hstact         ;host buffer inactive
62      0004 326c01  sta    unacct        ;clear unalloc count
63      0007 c9      ret
64                ;
65      home:
66                ;home the selected disk
67      home:
68      0008 3a6b01  lda    hstwrtr       ;check for pending write
69      000b b7      ora    a
70      000c c21200  jnz    homed
71      000f 326a01  sta    hstact         ;clear host active flag
72      homed:
73      0012 c9      ret
74                ;
75      seldsk:
76                ;select disk
77      0013 79      mov    a,c              ;selected disk number
78      0014 326101  sta    sekdisk        ;seek disk number
79      0017 6f      mov    l,a              ;disk number to hl
80      0018 2600   mvi    h,0
81                rept    4              ;multiply by 16
82                dad    h
83                endm
84      001a+29     dad    h
85      001b+29     dad    h
86      001c+29     dad    h
87      001d+29     dad    h
88      001e 110000 lxi    d,dpbase       ;base of parm block

```

```

89      0021 19      dad      d          ;hl=.dpb(curdsk)
90      0022 c9      ret
91      ;
92      settrk:
93      ;set track given by registers bc
94      0023 60      mov      h,b
95      0024 69      mov      l,c
96      0025 226201  shld    sektrk      ;track to seek
97      0028 c9      ret
98      ;
99      setsec:
100     ;set sector given by register c
101     0029 79      mov      a,c
102     002a 326401  sta      seksec      ;sector to seek
103     002d c9      ret
104     ;
105     setdma:
106     ;set dma address given by bc
107     002e 60      mov      h,b
108     002f 69      mov      l,c
109     0030 227501  shld    dmaadr
110     0033 c9      ret
111     ;
112     sectran:
113     ;translate sector number bc
114     0034 60      mov      h,b
115     0035 69      mov      l,c
116     0036 c9      ret
117     ;
118     ;
119     ;
120     ;          the read entry point takes the place of
121     ;          the previous bios definition for read.
122     ;
123     ;
124     read:
125     ;read the selected cp/m sector
126     0037 af      xra      a
127     0038 326c01  sta      unacnt
128     003b 3e01    mvi      a,1
129     003d 327301  sta      readop      ;read operation
130     0040 327201  sta      rsflag      ;must read data
131     0043 3e02    mvi      a,wrual
132     0045 327401  sta      wrtype      ;treat as unalloc
133     0048 c3b600  jmp      rwoper      ;to perform the read
134     ;
135     ;
136     ;
137     ;          the write entry point takes the place of
138     ;          the previous bios definition for write.
139     ;
140     ;
141     write:
142     ;write the selected cp/m sector
143     004b af      xra      a          ;0 to accumulator

```

```

144 004c 327301 sta readop ;not a read operation
145 004f 79 mov a,c ;write type in c
146 0050 327401 sta wrtype
147 0053 fe02 cpi wrual ;write unallocated?
148 0055 c26f00 jnz chkuna ;check for unalloc
149 ;
150 ; write to unallocated, set parameters
151 0058 3e10 mvi a,blksiz/128 ;next unalloc recs
152 005a 326c01 sta unacnt
153 005d 3a6101 lda sekdisk ;disk to seek
154 0060 326d01 sta unadsk ;unadsk = sekdisk
155 0063 2a6201 lhld sektrk
156 0066 226e01 shld unatrkr ;unatrkr = sektrk
157 0069 3a6401 lda seksec
158 006c 327001 sta unasec ;unasec = seksec
159 ;
160 ; chkuna:
161 ; check for write to unallocated sector
162 006f 3a6c01 lda unacnt ;any unalloc remain?
163 0072 b7 ora a
164 0073 caae00 jz alloc ;skip if not
165 ;
166 ; more unallocated records remain
167 0076 3d dcr a ;unacnt = unacnt-1
168 0077 326c01 sta unacnt
169 007a 3a6101 lda sekdisk ;same disk?
170 007d 216d01 lxi h,unadsk
171 0080 be cmp m ;sekdisk = unadsk?
172 0081 c2ae00 jnz alloc ;skip if not
173 ;
174 ; disks are the same
175 0084 216e01 lxi h,unatrkr
176 0087 cd5301 call sektrkrmp ;sektrkr = unatrkr?
177 008a c2ae00 jnz alloc ;skip if not
178 ;
179 ; tracks are the same
180 008d 3a6401 lda seksec ;same sector?
181 0090 217001 lxi h,unasec
182 0093 be cmp m ;seksec = unasec?
183 0094 c2ae00 jnz alloc ;skip if not
184 ;
185 ; match, move to next sector for future ref
186 0097 34 inr m ;unasec = unasec+1
187 0098 7e mov a,m ;end of track?
188 0099 fe50 cpi cpmspt ;count cp/m sectors
189 009b daa700 jc noovf ;skip if no overflow
190 ;
191 ; overflow to next track
192 009e 3600 mvi m,o ;unasec = o
193 00a0 2a6e01 lhld unatrkr
194 00a3 23 inx h
195 00a4 226e01 shld unatrkr ;unatrkr = unatrkr+1
196 ;
197 ; noovf:
198 ; match found, mark as unnecessary read
199 00a7 af xra a ;0 to accumulator

```

```

200      00ab 327201      sta      rsflag      ;rsflag = 0
201      00ab c3b600      jmp      rwoper      ;to perform the write
202      ;
203      alloc:
204      ;not an unallocated record, requires pre-read
205      00ae af          xra      a          ;0 to accum
206      00af 326c01      sta      unacnt     ;unacnt = 0
207      00b2 3c          inr      a          ;1 to accum
208      00b3 327201      sta      rsflag = 1 ;rsflag = 1
209      ;
210      ;
211      ;
212      ;          common code for read and write follows
213      ;
214      ;
215      rwoper:
216      ;enter here to perform the read/write
217      00b6 af          xra      a          ;zero to accum
218      00b7 327101      sta      erflag     ;no errors (yet)
219      00ba 3a6401      lda      seksec     ;compute host sector
220      rept      secshf
221      ora      a          ;carry = 0
222      rar      ;shift right
223      endm
224      00bd+b7          ora      a          ;carry = 0
225      00be+1f          rar      ;shift right
226      00bf+b7          ora      a          ;carry = 0
227      00c0+1f          rar      ;shift right
228      00c1 326901      sta      sekhst     ;host sector to seek
229      ;
230      ;          active host sector?
231      00c4 216a01      lxi      h,hstact   ;host active flag
232      00c7 7e          mov      a,m
233      00c8 3601          mvi      m,1        ;always becomes 1
234      00ca b7          ora      a          ;was it already?
235      00cb caf200      jz      filhst      ;fill host if not
236      ;
237      ;          host buffer active, same as seek buffer?
238      00ce 3a6101      lda      sekdisk
239      00d1 216501      lxi      h,hstdsk   ;same disk?
240      00d4 be          cmp      m          ;sekdisk = hstdsk?
241      00d5 c2eb00      jnz      nomatch
242      ;
243      ;          same disk, same track?
244      00d8 216601      lxi      h,hsttrk
245      00db cd5301      call     sektrkcmp  ;sektrk = hsttrk?
246      00de c2eb00      jnz      nomatch
247      ;
248      ;          same disk, same track, same buffer?
249      00e1 3a6901      lda      sekhst
250      00e4 216801      lxi      h,hstsec   ;sekhst = hstsec?
251      00e7 be          cmp      m
252      00e8 ca0f01      jz      match       ;skip if match
253      ;
254      nomatch:

```

```

255                                     ;proper disk, but not correct sector
256 00eb 3a6b01   lda      hstwrst   ;host written?
257 00ee b7       ora      a
258 00ef c45f01   cnz      writehst   ;clear host buff
259                                     ;
260                                     filhst:
261                                     ;may have to fill the host buffer
262 00f2 3a6101   lda      sekdisk
263 00f5 326501   sta      hstdsk
264 00f8 2a6201   lhld    sektrk
265 00fb 226601   shld    hsttrk
266 00fe 3a6901   lda      sekhst
267 0101 326801   sta      hstsec
268 0104 3a7201   lda      rsflag     ;need to read?
269 0107 b7       ora      a
270 0108 c46001   cnz      readhst    ;yes, if 1
271 010b af       xra      a           ;0 to accum
272 010c 326b01   sta      hstwrst   ;no pending write
273                                     ;
274                                     match:
275                                     ;copy data to or from buffer
276 010f 3a6401   lda      seksec     ;mask buffer number
277 0112 e603     ani      secmsk     ;least signif bits
278 0114 6f       mov     l,a         ;ready to shift
279 0115 2600     mvi     h,0         ;double count
280                                     rept    7           ;shift left 7
281                                     dad     h
282                                     endm
283 0117+29       dad     h
284 0118+29       dad     h
285 0119+29       dad     h
286 011a+29       dad     h
287 011b+29       dad     h
288 011c+29       dad     h
289 011d+29       dad     h
290                                     ; hl has relative host buffer address
291 011e 117701   lxi     d,hstbuf
292 0121 19       dad     d           ;hl = host address
293 0122 eb       xchg
294 0123 2a7501   lhld    dmaadr     ;get/put cp/m data
295 0126 0e80     mvi     c,128      ;length of move
296 0128 3a7301   lda      readop    ;which way?
297 012b b7       ora      a
298 012c c23501   jnz     rwmov     ;skip if read
299                                     ;
300                                     ; write operation, mark and switch direction
301 012f 3e01     mvi     a,1
302 0131 326b01   sta      hstwrst   ;hstwrst = 1
303 0134 eb       xchg           ;source/dest swap
304                                     ;
305                                     rwmov:
306                                     ;c initially 128, de is source, hl is dest
307 0135 1a       ldax   d           ;source character
308 0136 13       inx    d
309 0137 77       mov    m,a         ;to dest

```

```

310      0138 23          inx      h
311      0139 od          dcr      c                ;loop 128 times
312      013a c23501     jnz      rwmove
313      ;
314      ;                data has been moved to/from host buffer
315      013d 3a7401     lda      wrtype          ;write type
316      0140 fe01       cpi      wrdir           ;to directory?
317      0142 3a7101     lda      erflag          ;in case of errors
318      0145 c0         rnz      ;no further processing
319      ;
320      ;                clear host buffer for directory write
321      0146 b7         ora      a                ;errors?
322      0147 c0         rnz      ;skip if so
323      0148 af         xra      a                ;0 to accum
324      0149 326b01     sta      hstwrnt         ;buffer written
325      014c cd5f01     call     writehst
326      014f 3a7101     lda      erflag
327      0152 c9         ret
328      ;
329      ;
330      ;
331      ;                utility subroutine for 16-bit compare
332      ;
333      ;
334      ;                sektrcmp:
335      ;                ;hl = .unatrkl or .hsttrkl, compare with sektrk
336      0153 eb          xchg
337      0154 216201     lxi      h,sektrk
338      0157 1a         ldax     d                ;low byte compare
339      0158 be          cmp      m                ;same?
340      0159 c0         rnz      ;return if not
341      ;                low bytes equal, test high 1s
342      015a 13         inx      d
343      015b 23         inx      h
344      015c 1a         ldax     d
345      015d be          cmp      m                ;sets flags
346      015e c9         ret
347      ;
348      ;
349      ;
350      ;                writehst performs the physical write to
351      ;                the host disk, readhst reads the physical
352      ;                disk.
353      ;
354      ;
355      ;                writehst:
356      ;                ;hstdsk = host disk #, hsttrk = host track #,
357      ;                ;hstsec = host sect #. write "hstsiz" bytes
358      ;                ;from hstbuf and return error flag in erflag.
359      ;                ;return erflag non-zero if error
360      015f c9         ret
361      ;
362      ;                readhst:
363      ;                ;hstdsk = host disk #, hsttrk = host track #,
364      ;                ;hstsec = host sect #. read "hstsiz" bytes

```

```

365                                     ;into hstbuf and return error flag in erflag.
366 0160 c9                             ret
367                                     ;
368                                     ;
369                                     ;
370                                     ; uninitialized ram data areas
371                                     ;
372                                     ;
373                                     ;
374 0161 sekdisk: ds 1                   ;seek disk number
375 0162 sektrk: ds 2                   ;seek track number
376 0164 seksec: ds 1                   ;seek sector number
377                                     ;
378 0165 hstdsk: ds 1                   ;host disk number
379 0166 hstrk: ds 2                   ;host track number
380 0168 hstsec: ds 1                   ;host sector number
381                                     ;
382 0169 sekhst: ds 1                   ;seek shr secshf
383 016a hstact: ds 1                   ;host active flag
384 016b hstwrtr: ds 1                  ;host written flag
385                                     ;
386 016c unacct: ds 1                   ;unalloc rec cnt
387 016d unadsk: ds 1                   ;last unalloc disk
388 016e unatrck: ds 2                  ;last unalloc track
389 0170 unasec: ds 1                   ;last unalloc sector
390                                     ;
391 0171 erflag: ds 1                    ;error reporting
392 0172 rsflag: ds 1                    ;read sector flag
393 0173 readop: ds 1                    ;1 if read operation
394 0174 wrtype: ds 1                    ;write operation type
395 0175 dmaadr: ds 2                    ;last dma address
396 0177 hstbuf: ds hstsiz               ;host buffer
397                                     ;
398                                     ;
399                                     ;
400                                     ; the endif macro invocation goes here
401                                     ;
402                                     ;
403 0377 end

```

alloc	00ae	164	172	177	183	203#		
blksiz	0800	29#	151					
boot	0000	57#						
chkuna	006f	148	160#					
cpmspt	0050	33#	188					
dmaadr	0175	109	294	395#				
dpbase	0000	55#	88					
erflag	0171	218	317	326	391#			
filhst	00f2	235	260#					
home	0008	65#	67#					
homed	0012	70	72#					
hstact	016a	61	71	231	383#			
hstblk	0004	32#	33	34	35			
hstbuf	0177	291	396#					
hstdsk	0165	239	263	378#				
hstsec	0168	250	267	380#				
hstsiz	0200	30#	32	396				
hstcpt	0014	31#	33					
hsttrk	0166	244	265	379#				
hstwrt	016b	68	256	272	302	324	384#	
match	010f	252	274#					
nomatch	00eb	241	246	254#				
noovf	00a7	189	197#					
read	0037	124#						
readhst	0160	270	362#					
readop	0173	129	144	296	393#			
rsflag	0172	130	200	208	268	392#		
rwmove	0135	298	305#	312				
rwoper	00b6	133	201	215#				
secmsk	0003	34#	277					
secshf	0002	36#	220					
sectran	0034	112#						
sekdisk	0161	78	153	169	238	262	374#	
sekfst	0169	228	249	266	382#			
seksec	0164	102	157	180	219	276	376#	
sektrk	0162	96	155	264	337	375#		
sektrcmp	0153	176	245	334#				
seldsk	0013	75#						
setdma	002e	105#						
setsec	0029	99#						
settrk	0023	92#						
unacnt	016c	62	127	152	162	168	206	386#
unadsk	016d	154	170	387#				
unasec	0170	158	181	389#				
unatrak	016e	156	175	193	195	388#		
wboot	0000	58#						
wrall	0000	43#						
wkdir	0001	44#	316					
write	004b	141#						
writehst	015f	258	325	355#				
wrtype	0174	132	146	315	394#			
wruall	0002	45#	131	147				





## Appendix H: Glossary

**address:** Number representing the location of a byte in memory. Within CP/M there are two kinds of addresses: logical and physical. A physical address refers to an absolute and unique location within the computer's memory space. A logical address refers to the offset or displacement of a byte in relation to a base location. A standard CP/M program is loaded at address 0100H, the base value; the first instruction of a program has a physical address of 0100H and a relative address or offset of 0H.

**allocation vector (ALV):** An allocation vector is maintained in the BIOS for each logged in disk drive. A vector consists of a string of bits, one for each block on the drive. The bit corresponding to a particular block is set to one when the block has been allocated and to zero otherwise. The first two bytes of this vector are initialized with the bytes AL0 and AL1 on, thus allocating the directory blocks. CP/M Function 27 returns the allocation vector address.

**AL0, AL1:** Two bytes in the disk parameter block that reserve data blocks for the directory. These two bytes are copied into the first two bytes of the allocation vector when a drive is logged in. (See allocation vector.)

**ALV:** See allocation vector.

**ambiguous filename:** Filename that contains either of the CP/M wildcard characters, ? or \*, in the primary filename or the filetype, or both. When you replace characters in a filename with these wildcard characters, you create an ambiguous filename and can easily reference more than one CP/M file in a single command line.

**American Standard Code for Information Interchange:** See ASCII.

**applications program:** Program designed to solve a specific problem. Typical applications programs are business accounting packages, word processing (editing) programs and mailing list programs.

**archive attribute:** File attribute controlled by the high-order bit of the t3 byte (FCB+11) in a directory element. This attribute is set if the file has been archived.

**argument:** Symbol, usually a letter, indicating a place into which you can substitute a number, letter or name to give an appropriate meaning to the formula in question.

**ASCII:** American Standard Code for Information Interchange. ASCII is a standard set of seven-bit numeric character codes used to represent characters in memory. Each character requires one byte of memory with the high-order bit usually set to zero. Characters can be numbers, letters, and symbols. An ASCII file can be intelligibly displayed on the video screen or printed on paper.

**assembler:** Program that translates assembly language into the binary machine code. Assembly language is simply a set of mnemonics used to designate the instruction set of the CPU. (See ASM in Section 3 of this manual.)

**back-up:** Copy of a disk or file made for safekeeping, or the creation of the duplicate disk or file.

**Basic Disk Operating System:** See BDOS.

**BDOS:** Basic Disk Operating System. The BDOS module of the CP/M operating system provides an interface for a user program to the operating system. This interface is in the form of a set of function calls which may be made to the BDOS through calls to location 0005H in page zero. The user program specifies the number of the desired function in register C. User programs running under CP/M should use BDOS functions for all I/O operations to remain compatible with other CP/M systems and future releases. The BDOS normally resides in high memory directly below the BIOS.

**bias:** Address value which when added to the origin address of your BIOS module produces 1F80H, the address of the BIOS module in the MOVCPM image. There is also a bias value that when added to the BOOT module origin produces 0900H, the address of the BOOT module in the MOVCPM image. You must use these bias values with the R command under DDT or SID when you patch a CP/M system. If you do not, the patched system may fail to function.

**binary:** Base 2 numbering system. A binary digit can have one of two values: 0 or 1. Binary numbers are used in computers because the hardware can most easily exhibit two states: off and on. Generally, a bit in memory represents one binary digit.

**Basic Input/Output System:** See BIOS.

**BIOS:** Basic Input/Output System. The BIOS is the only hardware-dependent module of the CP/M system. It provides the BDOS with a set of primitive I/O operations. The BIOS is an assembly language module usually written by the user, hardware manufacturer or independent software vendor, and is the key to CP/M's portability. The BIOS interfaces the CP/M system to its hardware environment through a standardized jump table at the front of the BIOS routine and through a set of disk parameter tables which define the disk environment. Thus, the BIOS provides CP/M with a completely table-driven I/O system.

**BIOS base:** Lowest address of the BIOS module in memory, that by definition must be the first entry point in the BIOS jump table.

**bit:** Switch in memory that can be set to on (1) or off (0). Bits are grouped into bytes, eight bits to a byte, which is the smallest directly addressable unit in an Intel 8080 or Zilog Z-80. By common convention, the bits in a byte are numbered from right (0 for the low order bit) to left (7 for the high order bit). Bit values are often represented in hexadecimal notation by grouping the bits from the low order bit in groups of four. Each group of four bits can have a value from 0 to 15 and thus can easily be represented by one hexadecimal digit.

**BLM:** See block mask.

**block:** Basic unit of disk space allocation. Each disk drive has a fixed block size (BLS) defined in its disk parameter block in the BIOS. A block can consist of 1K, 2K, 4K, 8K or 16K consecutive bytes. Blocks are numbered relative to zero so that each block is unique and has a byte displacement in a file equal to the block number times the block size.

**block mask (BLM):** Byte value in the disk parameter block at DPB + 3. The block mask is always one less than the number of 128 byte sectors that are in one block. Note:  $BLM = (2^{**} BSH) - 1$ .

**block shift (BSH):** Byte parameter in the disk parameter block at DPB + 2. Values for the block shift and block mask (BLM) are determined by the block size (BLS). Note:  $BLM = (2^{**} BSH) - 1$ .

**blocking & deblocking algorithm:** In some disk subsystems the disk sector size is larger than 128 bytes, usually 256, 512, 1024 or 2048 bytes. When the host sector size is larger than 128 bytes, host sectors must be buffered in memory and the 128 byte CP/M sectors must be blocked and deblocked by adding an additional module, the blocking and deblocking algorithm, between the BIOS disk I/O routines and the actual disk I/O. The host sector size must be an even multiple of 128 bytes for the algorithm to work correctly. The blocking and deblocking algorithm allows the BDOS and BIOS to function exactly as if the entire disk consisted only of 128 byte sectors, as in the standard CP/M installation.

**BLS:** Block size in bytes. See block.

**boot:** Process of loading an operating system into memory. A boot program is a small piece of code that is automatically executed when you power-up or reset your computer. The boot program loads the rest of the operating system into memory in a manner similar to a person pulling himself up by his own bootstraps. This process is sometimes called a "cold boot" or "cold start." Bootstrap procedures vary from system to system. The boot program must be customized for the memory size and hardware environment that the operating system manages. Typically, the boot resides on the first sector of the system tracks on your system diskette. When executed, the boot loads the remaining sectors of the system tracks into high memory at the location for which the CP/M system has been configured. Finally, the boot transfers execution to the boot entry point in the BIOS jump table so that the system can initialize itself. In this case, the boot program should be placed at 900H in the SYSGEN image. Alternatively, the boot program may be located in ROM.

**bootstrap:** See boot.

**BSH:** See block shift.

**BTREE:** General purpose file access method that has become the standard organization for indexes in large data base systems. BTREE provides near optimum performance over the full range of file operations, such as insertion, deletion, search, and search next.

**buffer:** Area of memory that temporarily stores data during the transfer of information.

**built-in commands:** Commands that permanently reside in memory. They respond quickly because they are not accessed from a disk.

**byte:** Unit of memory or disk storage containing eight bits. A byte can represent a binary number between 0 and 255, and is the smallest unit of memory that can be addressed directly in 8 bit CPUs such as the Intel 8080 or Zilog Z-80.

**CCP:** Console Command Processor. The CCP is a module of the CP/M operating system. It is loaded directly below the BDOS module and interprets and executes commands typed by the console user. Usually these commands are programs that the CCP loads and calls. Upon completion, a command program may return control to the CCP if it has not overwritten it. If it has, the program can reload the CCP into memory by a warm boot operation initiated by either a jump to zero, BDOS system reset (function 0), or a cold boot. Except for its location in high memory, the CCP works like any other standard CP/M program; that is, it makes only BDOS function calls for its I/O operations.

**CCP base:** Lowest address of the CCP module in memory. This term sometimes refers to the base of the CP/M system in memory, as the CCP is normally the lowest CP/M module in high memory.

**checksum vector (CSV):** Contiguous data area in the BIOS, with one byte for each directory sector to be checked, i.e., CKS bytes. (See CKS.) A checksum vector is initialized and maintained for each logged in drive. Each directory access by the system results in a checksum calculation that is compared with the one in the checksum vector. If there is a discrepancy, the drive is set to read-only status. This feature prevents the user from inadvertently switching disks without logging in the new disk. If the new disk is not logged in, it is treated the same as the old one, and data on it may be destroyed if writing is done.

**CKS:** Number of directory records to be checked summed on directory accesses. This is a parameter in the disk parameter block located in the BIOS. If the value of CKS is zero, then no directory records are checked. CKS is also a parameter in the diskdef macro library, where it is the actual number of directory elements to be checked rather than the number of directory records.

**cold boot:** See boot. Cold boot also may refer to a jump to the boot entry point in the BIOS jump table.

**COM:** Filetype for a CP/M command file. See command file.

**command:** CP/M command line. In general, a CP/M command line has three parts: the command keyword, command tail, and a carriage return. To execute a command, enter a CP/M command line directly after the CP/M prompt at the console and press the carriage return or enter key.

**command file:** Executable program file of filetype COM. A command file is a machine language object module ready to be loaded and executed at the absolute address of 0100H. To execute a command file, enter its primary filename as the command keyword in a CP/M command line.

**command keyword:** Name that identifies a CP/M command, usually the primary filename of a file of type COM, or a built-in command. The command keyword precedes the command tail and the carriage return in the command line.

**command syntax:** Statement that defines the correct way to enter a command. The correct structure generally includes the command keyword, the command tail, and a carriage return. A syntax line usually contains symbols that you should replace with actual values when you enter the command.

**command tail:** Part of a command that follows the command keyword in the command line. The command tail can include a drive specification, a filename and/or filetype, and options or parameters. Some commands do not require a command tail.

**CON:** Mnemonic that represents the CP/M console device (see console). For example, the CP/M command "PIP CON:=TEST.SUB" displays the file TEST.SUB on the console device. The explanation of the STAT command tells how to assign the logical device CON: to various physical devices.

**concatenate:** Name of the PIP operation that copies two or more separate files into one new file in the specified sequence.

**concurrency:** Execution of two processes or operations simultaneously.

**CONIN:** BIOS entry point to a routine that reads a character from the console device.

**CONOUT:** BIOS entry point to a routine that sends a character to the console device.

**console:** Primary input/output device. The console consists of a listing device, such as a screen or teletype, and a keyboard through which the user communicates with the operating system or applications program.

**Console Command Processor:** See CCP.

**CONST:** BIOS entry point to a routine that returns the status of the console device.

**control character:** Nonprinting character combination. CP/M interprets some control characters as simple commands such as line editing functions. To enter a control character, hold down the CONTROL key and strike the specified character key.

**Control Program for Microcomputers:** See CP/M.

**CP/M:** Control Program for Microcomputers. An operating system that manages computer resources and provides a standard systems interface to software written for a large variety of microprocessor-based computer systems.

**CP/M 1.4 compatibility:** For a CP/M 2 system to be able to read correctly single density diskettes produced under a CP/M 1.4 system, the extent mask must be zero and the block size 1K. This is because under CP/M 2 an FCB may contain more than one extent. The number of extents that may be contained by an FCB is EXM+1. The issue of CP/M 1.4 compatibility also concerns random file I/O. To perform random file I/O under CP/M 1.4, you must maintain an FCB for each extent of the file. This scheme is upward compatible with CP/M 2 for files not exceeding 512K bytes, the largest file size supported under CP/M 1.4. If you wish to implement random I/O for files larger than 512K bytes under CP/M 2, you must use the random read and random write functions (BDOS functions 33, 34 and 36). In this case, only one FCB is used, and if CP/M 1.4 compatibility is required, the program must use the return version number function (BDOS function 12) to determine which method to employ.

**CP/M prompt:** Characters that indicate that CP/M is ready to execute your next command. The CP/M prompt consists of an upper-case letter (A-P) followed by a ">" character; for example, A>. The letter designates which drive is currently logged in as the default drive. CP/M will search this drive for the command file specified, unless the command is a built-in command or prefaced by a select drive command; for example, B:STAT.

**CP/NET:** Digital Research network operating system enabling microcomputers to obtain access to common resources via a network. CP/NET consists of MP/M masters and CP/M slaves with a network interface between them.

**CSV:** See checksum vector.

**cursor:** One-character symbol that can appear anywhere on the console screen. The cursor indicates the position where the next keystroke at the console will have an effect.

**data file:** File containing information that will be processed by a program.

**deblocking:** See blocking & deblocking algorithm.

**default:** Currently selected disk drive and user number. Any command that does not specify a disk drive or a user number references the default disk drive and user number. When CP/M is first invoked, the default disk drive is drive A, and the default user number is 0.

**default buffer:** Default 128-byte buffer maintained at 0080H in page zero. When the CCP loads a COM file, this buffer is initialized to the command tail; that is, any characters typed after the COM file name are loaded into the buffer. The first byte at 0080H contains the length of the command tail, while the command tail itself begins at 0081H. The command tail is terminated by a byte containing a binary zero value. The I command under DDT and SID initializes this buffer in the same way as the CCP.

**default FCB:** Two default FCBs are maintained by the CCP at 005CH and 006CH in page zero. The first default FCB is initialized from the first delimited field in the command tail, and the second default FCB is initialized from the next field in the command tail.

**delimiter:** Special characters that separate different items in a command line; for example, a colon separates the drive specification from the filename. The CCP recognizes the following characters as delimiters: . : = ; < > \_ , blank, and carriage return. Several CP/M commands also treat the following as delimiter characters: , [ ] ( ) \$ . It is advisable to avoid the use of delimiter characters and lower-case characters in CP/M file names.

**DIR:** Parameter in the diskdef macro library that specifies the number of directory elements on the drive.

**DIR attribute:** File attribute. A file with the DIR attribute can be displayed by a DIR command. The file can be accessed from the default user number and drive only.

**DIRBUF:** 128-byte scratchpad area for directory operations, usually located at the end of the BIOS. DIRBUF is used by the BDOS during its directory operations. DIRBUF also refers to the two-byte address of this scratchpad buffer in the disk parameter header at DPbase + 8 bytes.

**directory:** Portion of a disk that contains entries for each file on the disk. In response to the DIR command, CP/M displays the filenames stored in the directory. The directory also contains the locations of the blocks allocated to the files. Each file directory element is in the form of a 32-byte FCB, although one file may have several elements, depending on its size. The maximum number of directory elements supported is specified by the drive's disk parameter block value for DRM.

**directory element:** Data structure. Each file on a disk has one or more 32-byte directory elements associated with it. There are four directory elements per directory sector. Directory elements may also be referred to as directory FCBs.

**directory entry:** File entry displayed by the DIR command. Sometimes this term may refer to a physical directory element.

**disk, diskette:** Magnetic media used for mass storage in a computer system. Programs and data are recorded on the disk in the same way music can be recorded on cassette tape. The CP/M operating system must be initially loaded from disk when the computer is turned on. Diskette refers to smaller capacity removable floppy diskettes, while disk may refer to either a diskette, removable cartridge disk or fixed hard disk. Hard disk capacities range from five to several hundred megabytes of storage.

**diskdef macro library:** Library of code that when used with MAC (the Digital Research macro assembler) creates disk definition tables such as the DPB and DPH automatically.

**disk drive:** Peripheral device that reads and writes information on disk or diskettes. CP/M assigns a letter to each drive under its control. For example, CP/M may refer to the drives in a four-drive system as A, B, C, and D.

**disk parameter block (DPB):** Data structure referenced by one or more disk parameter headers. The disk parameter block defines disk characteristics in the fields listed below:

SPT	The total number of sectors per track
BSH	The data allocation block shift factor
BLM	The data allocation block mask
EXM	The extent mask determined by BLS and DSM
DSM	The maximum data block number
DRM	Maximum number of directory entries—1
AL0	Reserves directory blocks
AL1	Reserves directory blocks
CKS	The number of directory sectors check summed
OFF	The number of reserved system tracks

The address of the disk parameter block is located in the disk parameter header at DPbase + 0AH. CP/M Function 31 returns the DPB address. Drives with the same characteristics may use the same disk parameter header, and thus the same DPB. However, drives with different characteristics must each have their own disk parameter header and disk parameter blocks. When the BDOS calls the SELDSK entry point in the BIOS, SELDSK must return the address of the drive's disk parameter header in registers HL.

**disk parameter header (DPH):** Data structure that contains information about the disk drive and provides a scratchpad area for certain BDOS operations. The disk parameter header contains six bytes of scratchpad area for the BDOS, and the following five two-byte parameters:

XLT	The sector translation table address
DIRBUF	Directory buffer address
DPB	Disk parameter block address
CSV	Checksum vector address
ALV	Allocation vector address

Given *n* disk drives, the disk parameter headers are arranged in a table whose first row of 16 bytes corresponds to drive 0, with the last row corresponding to drive *n*-1.

**DKS:** Parameter in the diskdef macro library specifying the number of data blocks on the drive.

**DMA:** Direct memory access. DMA is a method of transferring data from the disk into memory directly. In a CP/M system, the BDOS calls the BIOS entry point READ to read a sector from the disk into the currently selected DMA address. The DMA address must be



the address of a 128-byte buffer in memory, either the default buffer at 0080H in page zero, or a user-assigned buffer in the TPA. Similarly, the BDOS calls the BIOS entry point WRITE to write the record at the current DMA address to the disk.

**DN:** Parameter in the diskdef macro library specifying the logical drive number.

**DPB:** See disk parameter block.

**DPH:** See disk parameter header.

**DRM:** 2-byte parameter in the disk parameter block at DPB + 7. DRM is one less than the total number of directory entries allowed for the drive. This value is related to DPB bytes AL0 and AL1, which allocate up to 16 blocks for directory entries.

**DSM:** 2-byte parameter of the disk parameter block at DPB + 5. DSM is the maximum data block number supported by the drive. The product BLS times (DSM+1) is the total number of bytes held by the drive. This must not exceed the capacity of the physical disk less the reserved system tracks.

**editor:** Utility program that creates and modifies text files. An editor can be used for creation of documents or creation of code for computer programs. The CP/M editor is invoked by typing the command ED next to the system prompt on the console.

**EX:** Extent number field in an FCB. See extent.

**executable:** Ready to be run by the computer. Executable code is a series of instructions that can be carried out by the computer. For example, the computer cannot execute names and addresses, but it can execute a program that prints all those names and addresses on mailing labels.

**execute a program:** Start the processing of executable code.

**EXM:** See extent mask.

**extent:** 16K consecutive bytes in a file. Extents are numbered from 0 to 31. One extent may contain 1, 2, 4, 8 or 16 blocks. EX is the extent number field of an FCB and is a one byte field at FCB + 12, where FCB labels the first byte in the FCB. Depending on the block size (BLS) and the maximum data block number (DSM), an FCB may contain 1, 2, 4, 8 or 16 extents. The EX field is normally set to 0 by the user but contains the current extent number during file I/O. The term FCB folding describes FCBs containing more than one extent. In CP/M version 1.4, each FCB contained only one extent. Users attempting to perform random record I/O and maintain CP/M 1.4 compatibility should be aware of the implications of this difference. See CP/M 1.4 compatibility.

**extent mask (EXM):** A byte parameter in the disk parameter block located at DPB + 3. The value of EXM is determined by the block size (BLS) and whether the maximum data block number (DSM) exceeds 255. There are EXM + 1 extents per directory FCB.

**FCB:** See file control block.

**file:** Collection of characters, instructions, or data that can be referenced by a unique identifier. Files are usually stored on various types of media, such as disks, diskettes, or magnetic tape. A CP/M file is identified by a file specification and resides on disk as a collection of from zero to 65,536 records. Each record is 128 bytes and can contain either binary or ASCII data. Binary files contain bytes of data that can vary in value from 0H to

**OFFH.** ASCII files contain sequences of character codes delineated by a carriage return-line feed combination; normally byte values range from 0H to 7FH. The directory maps the file as a series of physical blocks. Although files are defined as a sequence of consecutive logical records, these records may not reside in consecutive sectors on the disk. (see also block, directory, extent, record, sector).

**file control block (FCB):** Structure used for accessing files on disk. Contains the drive, filename, filetype, and other information describing a file to be accessed or created on the disk. A file control block consists of 36 consecutive bytes specified by the user for file I/O functions. FCB can also refer to a directory element in the directory portion of the allocated disk space. These contain the same first 32 bytes of the FCB, but lack the current record and random record number bytes.

**filename:** Name assigned to a file. A filename can include a primary filename of 1-8 characters and a filetype of 0-3 characters. A period separates the primary filename from the filetype.

**file specification:** Unique file identifier. A complete CP/M file specification includes a disk drive specification followed by a colon (d:), a primary filename of 1 to 8 characters, a period and a filetype of 0 to 3 characters. For example, b:example.tex is a complete CP/M file specification.

**filetype:** Extension to a filename. A filetype can be from 0 to 3 characters and must be separated from the primary filename by a period. A filetype can tell something about the file. Some programs require that files to be processed have specific filetypes.

**floppy disk:** Flexible magnetic disk used to store information. Floppy disks come in 5¼- and 8-inch diameters.

**FSC:** Parameter in the diskdef macro library specifying the first physical sector number. This parameter is used to determine SPT and build XLT.

**hard disk:** Rigid, platter-like, magnetic disk sealed in a container. A hard disk stores more information than a floppy disk.

**hardware:** Physical components of a computer.

**hexadecimal notation:** Notation for base 16 values using the decimal digits and letters A, B, C, D, E & F to represent the 16 digits. Hexadecimal notation is often used to refer to binary numbers. A binary number can be easily expressed as a hexadecimal value by taking the bits in groups of 4 starting with the least significant bit, and expressing each group as a hexadecimal digit, (0-F). Thus the bit value 1011 becomes 0BH and 10110101 becomes 0B5H.

**hex file:** ASCII-printable representation of a command (machine language) file.

**hex file format:** Absolute output of ASM and MAC for the Intel 8080 is a hex format file, containing a sequence of absolute records that give a load address and byte values to be stored, starting at the load address.

**HOME:** BIOS entry point which sets the disk head of the currently selected drive to the track zero position.

**host:** Physical characteristics of a hard disk drive in a system using the blocking and deblocking algorithm. The term "host" helps distinguish physical hardware characteris-

tics from CP/M's logical characteristics. For example, CP/M sectors are always 128 bytes, although the host sector size may be a multiple of 128 bytes.

**input:** Data going into the computer, usually from an operator typing at the terminal or by a program reading from the disk.

**input/output:** See I/O.

**interface:** Object that allows two independent systems to communicate with each other, as an interface between hardware and software in a microcomputer.

**I/O:** Abbreviation for input/output. Usually refers to input/output operations or routines handling the input and output of data in the computer system.

**IOBYTE:** A one byte field in page zero, currently at location 0003H, that can support a logical-to-physical device mapping for I/O. However, its implementation in your BIOS is purely optional and may or may not be supported in a given CP/M system. The IOBYTE is easily set using the command:

```
STAT <logical device> = <physical device>
```

The CP/M logical devices are CON:, RDR:, PUN:, AND LST:; each of these can be assigned to one of four physical devices. The IOBYTE may be initialized by the BOOT entry point of the BIOS and interpreted by the BIOS I/O entry points CONST, CONIN, CONOUT, LIST, PUNCH, and READER. Depending on the setting of the IOBYTE, different I/O drivers may be selected by the BIOS. For example, setting LST:=TTY: might cause LIST output to be directed to a serial port, while setting LST:=LPT: causes LIST output to be directed to a parallel port.

**K:** Abbreviation for kilobyte. See kilobyte.

**keyword:** See command keyword.

**kilobyte (K):** 1024 bytes or 0400H bytes of memory. This is a standard unit of memory. For example, the Intel 8080 supports up to 64K of memory address space or 65,536 bytes. 1024 kilobytes equal one megabyte, or over one million bytes.

**linker:** Utility program used to combine relocatable object modules into an absolute file ready for execution. For example, LINK-80 creates either a COM or PRL file from relocatable REL files, such as those produced by PL/I-80.

**LIST:** A BIOS entry point to a routine that sends a character to the list device, usually a printer.

**list device:** Device such as a printer onto which data can be listed or printed.

**LISTST:** BIOS entry point to a routine that returns the ready status of the list device

**loader:** Utility program that brings an absolute program image into memory ready for execution under the operating system, or a utility used to make such an image. For example, LOAD prepares an absolute COM file from the assembler hex file output which is ready to be executed under CP/M.

**logged in:** Made known to the operating system, in reference to drives. A drive is logged in when it is selected by the user or an executing process. It remains selected or logged in until you change disks in a floppy disk drive or enter ctl-C at the command level, or until a BDOS function 0 is executed.

**logical:** Representation of something that may or may not be the same in its actual physical form. For example, a hard disk can occupy one physical drive, yet you can divide the available storage on it to appear to the user as if it were in several different drives. These apparent drives are the logical drives.

**logical sector:** See sector.

**logical to physical sector translation table:** See XLT.

**LSC:** Diskdef macro library parameter specifying the last physical sector number.

**LST:** Logical CP/M list device (usually a printer). The CP/M list device is an output-only device referenced through the LIST and LISTST entry points of the BIOS. The STAT command allows assignment of LST: to one of the physical devices: TTY:, CRT:, LPT:, or UL1:, provided these devices and the IOBYTE are implemented in the LIST and LISTST entry points of your CP/M BIOS module. The CP/NET command NETWORK allows assignment of LST: to a list device on a network master. An example of how LST: is used in a command: PIP LST:=TEST.SUB prints the file TEST.SUB on the list device.

**macro assembler:** Assembler code translator providing macro processing facilities. Macro definitions allow groups of instructions to be stored and substituted in the source program as the macro names are encountered. Definitions and invocations may be nested and macro parameters can be formed to pass arbitrary strings of text to a specific macro for substitution during expansion.

**megabyte:** Over one million bytes; 1024 kilobytes. See byte, kilobyte.

**microprocessor:** Silicon chip that is the central processing unit (CPU) of the microcomputer. The Intel 8080 and the Zilog Z-80 are microprocessors commonly used in CP/M systems.

**MOVCPM image:** Memory image of the CP/M system created by MOVCPM. This image may be saved as a disk file using the SAVE command or placed on the system tracks using the SYSGEN command without specifying a source drive. This image varies, depending on the presence of a one-sector or two-sector boot. If the boot is less than 128 bytes (one sector), the boot begins at 0900H, the CP/M system at 0980H, and the BIOS at 1F80H. Otherwise, the boot is at 0900H, the CP/M system at 1000H, and the BIOS at 2000H. In a CP/M 1.4 system with a one-sector boot, the addresses are the same as for the CP/M 2 system—except that the BIOS begins at 1E80H instead of 1F80H.

**MP/M:** Multi-Programming Monitor control program. A microcomputer operating system supporting multi-terminal access with multi-programming at each terminal.

**multi-programming:** The capability of initiating and executing more than one program at a time. These programs, usually called processes, are time-shared, each receiving a slice of CPU time on a "round-robin" basis. See concurrency.

**nibble:** One half of a byte, usually the high order or low order 4 bits in a byte.

**OFF:** Two byte parameter in the disk parameter block at DPB + 13 bytes. This value specifies the number of reserved system tracks. The disk directory begins in the first sector of track OFF.

**OFS:** Diskdef macro library parameter specifying the number of reserved system tracks. See OFF.

**operating system:** Collection of programs that supervises the execution of other programs and the management of computer resources. An operating system provides an orderly input/output environment between the computer and its peripheral devices. It enables user-written programs to execute safely. An operating system standardizes the use of computer resources for the programs running under it.

**option:** One of many parameters that can be part of a command tail. Use options to specify additional conditions for a command's execution.

**output:** Data that is sent to the console, disk, or printer.

**page:** 256 consecutive bytes in memory beginning on a page boundary, whose base address is a multiple of 256 (100H) bytes. In hex notation, pages always begin at an address with a least significant byte of zero.

**page relocatable program:** See PRL.

**page zero:** Memory region between 0000H and 0100H used to hold critical system parameters. Page zero functions primarily as an interface region between user programs and the CP/M BDOS module. Note: in non-standard systems this region is the base page of the system and represents the first 256 bytes of memory used by the CP/M system and user programs running under it.

**parameter:** Value in the command tail that provides additional information for the command. Technically, a parameter is a required element of a command.

**peripheral devices:** Devices external to the CPU. For example, terminals, printers, and disk drives are common peripheral devices that are not part of the processor but are used in conjunction with it.

**physical:** Characteristic of computer components, generally hardware, that actually exist. In programs, physical components can be represented by logical components.

**primary filename:** First 8 characters of a filename. The primary filename is a unique name that helps the user identify the file contents. A primary filename contains 1 to 8 characters and can include any letter or number and some special characters. The primary filename follows the optional drive specification and precedes the optional filetype.

**PRL:** Page relocatable program. A page relocatable program is stored on diskette as a file of type PRL. Page relocatable programs are easily relocated to any page boundary and thus are suitable for execution in a non-banked MP/M system.

**program:** Series of coded instructions that performs specific tasks when executed by a computer. A program can be written in a processor-specific language or a high-level language that can be implemented on a number of different processors.

**prompt:** Any characters displayed on the video screen to help the user decide what the next appropriate action is. A system prompt is a special prompt displayed by the operating system. See CP/M prompt. The alphabetic character indicates the default drive. Some applications programs have their own special prompts.

**PUN:** Logical CP/M punch device. The punch device is an output-only device accessed through the PUNCH entry point of the BIOS. In certain implementations, PUN: can be a serial device such as a modem.

**PUNCH:** BIOS entry point to a routine that sends a character to the punch device.

**RDR:** Logical CP/M reader device. The reader device is an input-only device accessed through the **READER** entry point in the BIOS. See **PUN**.

**READ:** Entry point in the BIOS to a routine that reads 128 bytes from the currently selected drive, track, and sector into the current DMA address.

**READER:** Entry point to a routine in the BIOS that reads the next character from the currently assigned reader device.

**read-only (R O):** Attribute that can be assigned to a disk file or a disk drive. When assigned to a file, the read-only attribute allows you to read from that file but not write to it. When assigned to a drive, the read-only attribute allows you to read any file on the disk, but prevents you from adding a new file, erasing or changing a file, renaming a file, or writing on the disk. The **STAT** command can set a file or a drive to read-only. Every file and drive is either read-only or read-write. The default setting for drives and files is read-write, but an error in resetting the disk or changing media automatically sets the drive to read-only until the error is corrected. See also **ROM**.

**read-write (R W):** Attribute that can be assigned to a disk file or a disk drive. The read-write attribute allows you to read from and write to a specific read-write file or to any file on a disk that is in a drive set to read-write. A file or drive can be set to either read-only or read-write.

**record:** Group of bytes in a file. A physical record consists of 128 bytes and is the basic unit of data transfer between the operating system and the application program. A logical record may vary in length and is used to represent a unit of information. Two 64 byte "employee" records can be stored in one 128-byte physical record. Records are grouped together to form a file.

**recursive procedure:** Code that may call itself during execution.

**reentrant procedure:** Code that can be called by one process while another is already executing it. Thus, reentrant code may be shared between different users. Reentrant procedures must not be self-modifying; that is, they must be pure code and not contain data. The data for reentrant procedures can be kept in a separate data area or placed on the stack.

**restart (RST):** One-byte call instruction usually used during interrupt sequences and for debugger break pointing. There are eight restart locations, **RST 0** through **RST 7**, whose addresses are given by the product of 8 times the restart number.

**RO:** See read-only.

**ROM:** Read-only memory. This memory can be read but not written and so is suitable for code and preinitialized data areas only.

**RST:** See restart.

**RW:** See read-write.

**sector:** In a CP/M system, a sector is always 128 consecutive bytes. A sector is the basic unit of data read and written on the disk by the BIOS. A sector can be one 128-byte record in a file or a sector of the directory. The **BDOS** always requests a logical sector number between 0 and (SPT-1). This is typically translated into a physical sector by the BIOS entry point **SECTAN**. In some disk subsystems, the disk sector size is larger than 128 bytes, usually a power of two such as 256, 512, 1024 or 2048 bytes. These disk sectors are

always referred to as host sectors in CP/M documentation and should not be confused with other references to sectors, in which cases the CP/M 128 byte sectors should be assumed. When the host sector size is larger than 128 bytes, host sectors must be buffered in memory and the 128 byte CP/M sectors must be blocked and deblocked from them. This may be done by adding an additional module, the blocking and deblocking algorithm, between the BIOS disk I/O routines and the actual disk I/O.

**sectors per track (SPT):** A two byte parameter in the disk parameter block at DPB + 0. The BDOS makes calls to the BIOS entry point SECTTRAN with logical sector numbers ranging between 0 and (SPT - 1) in register BC.

**SECTTRAN:** Entry point to a routine in the BIOS that performs logical to physical sector translation for the BDOS.

**SELDSK:** Entry point to a routine in the BIOS that sets the currently selected drive.

**SETDMA:** Entry point to a routine in the BIOS that sets the currently selected DMA address. The DMA address is the address of a 128-byte buffer region in memory that is used to transfer data to and from the disk in subsequent reads and writes.

**SETSEC:** Entry point to a routine in the BIOS that sets the currently selected sector.

**SETTRK:** Entry point to a routine in the BIOS that sets the currently selected track.

**skew factor:** Factor that defines the logical to physical sector number translation in XLT. Logical sector numbers are used by the BDOS and range between 0 and (SPT-1). Data is written in consecutive logical 128-byte sectors grouped in data blocks. The number of sectors per block is given by BLS/128. Physical sectors on the disk media are also numbered consecutively. If the physical sector size is also 128 bytes, a one-to-one relationship exists between logical and physical sectors. The logical to physical translation table (XLT) maps this relationship, and a skew factor is typically used in generating the table entries. For instance, if the skew factor is 6, XLT will be:

Logical:	0	1	2	3	4	5	6	...	25
Physical:	1	7	13	19	25	5	11	...	22

The skew factor allows time for program processing without missing the next sector. Otherwise, the system must wait for an entire disk revolution before reading the next logical sector. The skew factor can be varied, depending on hardware speed and application processing overhead. Note that no sector translation is done when the physical sectors are larger than 128 bytes, as sector deblocking is done in this case. (See also sector, SKF and XLT)

**SKF:** A diskdef macro library parameter specifying the skew factor to be used in building XLT. If SKF is zero, no translation table is generated and the XLT byte in the DPH will be 0000H.

**software:** Programs that contain machine-readable instructions, as opposed to hardware, which is the actual physical components of a computer.

**source file:** ASCII text file usually created with an editor, which is an input file to a system program such as a language translator or text formatter.

**SP:** Stack pointer. See stack.

**spooling:** Process of accumulating printer output in a file while the printer is busy. The file is printed when the printer becomes free; a program does not have to wait for the slow printing process.

**SPT:** See sectors per track.

**stack:** Reserved area of memory where the processor saves the return address when a call instruction is received. When a return instruction is encountered, the processor restores the current address on the stack to the program counter. Data such as the contents of the registers can also be saved on the stack. The push instruction places data on the stack and the pop instruction removes it. An item is pushed onto the stack by decrementing the stack pointer (SP) by 2 and writing the item at the SP address. In other words, the stack grows downward in memory.

**syntax:** Format for entering a given command.

**SYS:** See system attribute.

**SYSGEN image:** Memory image of the CP/M system created by `SYSGEN` when a destination drive is not specified. This is the same as the `MOVCPM` image, which can be read by `SYSGEN` if a source drive is not specified. See `MOVCPM` image.

**system attribute (SYS):** File attribute. You can give a file the system attribute by using the `SYS` option in the `STAT` command or by using the set file attributes function (BDOS function 12). A file with the `SYS` attribute is not displayed in response to a `DIR` command. If you give a file with user number 0 the `SYS` attribute, you can read and execute that file from any user number on the same drive. Use this feature to make your commonly used programs available under any user number.

**system prompt:** Symbol displayed by the operating system indicating that the system is ready to receive input. See `prompt`, `CP/M prompt`.

**system tracks:** Tracks reserved on the disk for the CP/M system. The number of system tracks is specified by the parameter `OFF` in the disk parameter block (DPB). The system tracks for a drive always precede its data tracks. The command `SYSGEN` copies the CP/M system from the system tracks to memory, and vice versa. The standard `SYSGEN` utility copies 26 sectors from track 0 and 26 sectors from track 1. When the system tracks contain additional sectors or tracks to be copied, a customized `SYSGEN` must be used.

**terminal:** See `console`.

**TPA:** Transient program area. Area in memory where user programs run and store data. This area is a region of memory beginning at 0100H and extending to the base of the CP/M system in high memory. The first module of the CP/M system is the `CCP`, which may be overwritten by a user program. If so, the TPA is extended to the base of the CP/M `BDOS` module. If the `CCP` is overwritten, the user program must terminate with either a system reset (function 0) call or a jump to location zero in page zero. The address of the base of the CP/M `BDOS` is stored in location 0006H in page zero, least significant byte first.

**track:** Data on the disk media is accessed by combination of track and sector numbers. Tracks form concentric rings on the disk; the standard IBM single-density diskettes have 77 tracks. Each track consists of a fixed number of numbered sectors. Tracks are numbered from 0 to one less than the number of tracks on the disk.

**transient program area:** See `TPA`.



**upward compatible:** Term meaning that a program created for the previously released operating system (or compiler, etc.) runs under the newly released version of the same operating system.

**USER:** Term used in CP/M and MP/M systems to distinguish distinct regions of the directory.

**user number:** Number assigned to files in the disk directory so that different users need only deal with their own files and have their "own" directories, even though they are all working from the same disk. In CP/M, files can be divided into 16 user groups.

**utility:** "Tool." Program that enables the user to perform certain operations, such as copying files, erasing files, and editing files. The utilities are created for the convenience of programmers and users.

**vector:** Location in memory. An entry point into the operating system used for making system calls or interrupt handling.

**warm start:** Program termination by: a jump to the warm start vector at location 0000H, a system reset (BDOS function 0), or a ctl-C typed at the keyboard. A warm start reinitializes the disk subsystem and returns control to the CP/M operating system at the CCP level. The warm start vector is simply a jump to the WBOOT entry point in the BIOS.

**WBOOT:** Entry point to a routine in the BIOS used when a warm start occurs. A warm start is performed when a user program branches to location 0000H, when the CPU is reset from the front panel, or when the user types ctl-C. The CCP and BDOS are reloaded from the system tracks of drive A.

**wildcard characters:** Special characters that match certain specified items. In CP/M there are two wildcard characters: ? and \*. The ? can be substituted for any single character in a filename, and the \* can be substituted for the primary filename or the filetype, or both. By placing wildcard characters in filenames, the user creates an ambiguous filename and can quickly reference one or more files.

**word:** 16-bit or two-byte value, such as an address value. Although the Intel 8080 is an 8-bit CPU, addresses occupy two bytes and are called word values.

**WRITE:** Entry point to a routine in the BIOS that writes the record at the currently selected DMA address to the currently selected drive, track, and sector.

**XLT:** Logical to physical sector translation table located in the BIOS. SECTTRAN uses XLT to perform logical to physical sector number translation. XLT also refers to the two-byte address in the disk parameter header at DPBASE + 0. If this parameter is zero, no sector translation takes place. Otherwise this parameter is the address of the translation table.

**ZERO PAGE:** See page zero.

## Appendix I: CP/M Messages

Messages come from several different sources. CP/M displays error messages when there are errors in calls to the Basic Disk Operating System (BDOS). CP/M also displays messages when there are errors in command lines. Each utility supplied with CP/M has its own set of messages. The following lists CP/M messages and utility messages. One might see messages other than those listed here if one is running an application program. Check the application program's documentation for explanations of those messages.

### Message

### Meaning

?

DDT. This message has four possible meanings:

- 1) DDT does not understand the assembly language instruction.
- 2) The file cannot be opened.
- 3) A checksum error occurred in a HEX file.
- 4) The assembler/disassembler was overlaid.

### ABORTED

PIP. You stopped a PIP operation by pressing a key.

### ASM Error Messages

- D Data error: data statement element cannot be placed in specified data area.
- E Expression error: expression cannot be evaluated during assembly.
- L Label error: label cannot appear in this context (might be duplicate label).
- N Not implemented: unimplemented features, such as macros, are trapped.
- O Overflow: expression is too complex to evaluate.
- P Phase error: label value changes on two passes through assembly.
- R Register error: the value specified as a register is incompatible with the code.

- S Syntax error: improperly formed expression.
- U Undefined label: label used does not exist.
- V Value error: improperly formed operand encountered in an expression.

#### BAD DELIMITER

STAT. Check command line for typing errors.

#### Bad Load

CCP error message, or SAVE error message.

#### Bdos Err. On d:

Basic Disk Operating System Error on the designated drive: CP/M replaces d: with the drive specification of the drive where the error occurred. This message is followed by one of the four phrases in the situations described below.

#### Bdos Err On d: Bad Sector

This message appears when CP/M finds no disk in the drive, when the disk is improperly formatted, when the drive latch is open, or when power to the drive is off. Check for one of these situations and try again. This could also indicate a hardware problem or a worn or improperly formatted disk. Press IC to terminate the program and return to CP/M, or press the return key to ignore the error.

#### Bdos Err On d: File R/O

You tried to erase, rename, or set file attributes on a Read-Only file. The file should first be set to Read-Write (RW) with the command: "STAT filespec \$R/W."

#### Bdos Err On d: R/O

Drive has been assigned Read Only status with a STAT command, or the disk in the drive has been changed without being initialized with a IC. CP/M terminates the current program as soon as you press any key.

#### Bdos Err on d: Select

CP/M received a command line specifying a nonexistent drive. CP/M terminates the current program as soon as you press any key. Press return key or CTRL-C to recover.

#### Break "x" at c

ED. "x" is one of the symbols described below and c is the command letter being executed when the error occurred.

- # Search failure. ED cannot find the string specified in an F, S, or N command.
- ? Unrecognized command letter c. ED does not recognize the indicated command letter, or an E, H, Q, or O command is not alone on its command line.

- O The file specified in an R command cannot be found.
- > Buffer full. ED cannot put any more characters in the memory buffer, or the string specified in an F, N, or S command is too long.
- E Command aborted. A keystroke at the console aborted command execution.
- F Disk or directory full. This error is followed by either the disk or directory full message. Refer to the recovery procedures listed under these messages.

#### CANNOT CLOSE DESTINATION FILE-- {filespec}

PIP. An output file cannot be closed. You should take appropriate action after checking to see if the correct disk is in the drive and that the disk is not write-protected.

#### Cannot close, R/O CANNOT CLOSE FILES

CP/M cannot write to the file. This usually occurs because the disk is write-protected.

ASM. An output file cannot be closed. This is a fatal error that terminates ASM execution. Check to see that the disk is in the drive, and that the disk is not write-protected.

DDT. The disk file written by a W command cannot be closed. This is a fatal error that terminates DDT execution. Check if the correct disk is in the drive and that the disk is not write-protected.

SUBMIT. This error can occur during SUBMIT file processing. Check if the correct system disk is in the A drive and that the disk is not write-protected. The SUBMIT job can be restarted after rebooting CP/M.

#### CANNOT READ

PIP. PIP cannot read the specified source. Reader may not be implemented.

#### CANNOT WRITE

PIP. The destination specified in the PIP command is illegal. You probably specified an input device as a destination.

#### Checksum error

PIP. A hex record checksum error was encountered. The hex record that produced the error must be corrected, probably by recreating the hex file.

#### CHECKSUM ERROR LOAD ADDRESS hhhh ERROR ADDRESS hhhh BYTES READ: hhhh:

LOAD. File contains incorrect data. Regenerate hex file from the source.

#### Command Buffer Overflow

SUBMIT. The SUBMIT buffer allows up to 2048 characters in the input file.

#### Command too long

SUBMIT. A command in the SUBMIT file cannot exceed 125 characters.

#### CORRECT ERROR, TYPE RETURN OR CTL-Z

PIP. A hex record checksum was encountered during the transfer of a hex file. The hex file with the checksum error should be corrected, probably by recreating the hex file.

#### DESTINATION IS R/O, DELETE (Y/N)?

PIP. The destination file specified in a PIP command already exists and it is Read Only. If you type Y, the destination file is deleted before the file copy is done.

#### Directory full

ED. There is not enough directory space for the file being written to the destination disk. You can use the OXfilespec command to erase any unnecessary files on the disk without leaving the editor.

SUBMIT. There is not enough directory space to write the \$\$\$SUB file used for processing SUBMITs. Erase some files or select a new disk and retry.

#### Disk full

ED. There is not enough disk space for the output file. This error can occur on the W, E, H, or X commands. If it occurs with X command, you can repeat the command prefixing the filename with a different drive.

#### DISK READ ERROR— {filespec}

PIP. The input disk file specified in a PIP command cannot be read properly. This is usually the result of an unexpected end-of-file. Correct the problem in your file.

#### DISK WRITE ERROR— {filespec}

DDT. A disk write operation cannot be successfully performed during a W command, probably due to a full disk. You should either erase some unnecessary files or get another disk with more space.

PIP. A disk write operation cannot be successfully performed during a PIP command, probably due to a full disk. You should either erase some unnecessary files or get another disk with more space and execute PIP again.

SUBMIT. The SUBMIT program cannot write the \$\$\$SUB file to the disk. Erase some files, or select a new disk and try again.

#### ERROR: BAD PARAMETER

PIP. You entered an illegal parameter in a PIP command. Retype the entry correctly.

**ERROR: CANNOT OPEN SOURCE, LOAD ADDRESS hhhh**

LOAD. Displayed if LOAD cannot find the specified file or if no filename is specified.

**ERROR: CANNOT CLOSE FILE, LOAD ADDRESS hhhh**

LOAD. Caused by an error code returned by a BDOS function call. Disk may be write-protected.

**ERROR: CANNOT OPEN SOURCE, LOAD ADDRESS hhhh**

LOAD. Cannot find source file. Check disk directory.

**ERROR: DISK READ, LOAD ADDRESS hhhh**

LOAD. Caused by an error code returned by a BDOS function call.

**ERROR: DISK WRITE, LOAD ADDRESS hhhh**

LOAD. Destination Disk is full.

**ERROR: INVERTED LOAD ADDRESS, LOAD ADDRESS hhhh**

LOAD. The address of a record was too far from the address of the previously-processed record. This is an internal limitation of LOAD, but it can be circumvented. Use DDT to read the hexfile into memory, then use a SAVE command to store the memory image file on disk.

**ERROR: NO MORE DIRECTORY SPACE, LOAD ADDRESS hhhh**

LOAD. Disk directory is full.

**Error on line nnn message**

SUBMIT. The SUBMIT program displays its messages in the format shown above, where nnn represents the line number of the SUBMIT file. Refer to the message following the line number.

**FILE ERROR**

ED. Disk or directory is full, and ED cannot write anything more on the disk. This is a fatal error, so make sure there is enough space on the disk to hold a second copy of the file before invoking ED.

**FILE EXISTS**

You have asked CP/M to create or rename a file using a file specification that is already assigned to another file. Either delete the existing file or use another file specification.

REN. The new name specified is the name of a file that already exists. You cannot rename a file with the name of an existing file. If you want to replace an existing file with a newer version of the same file, either rename or erase the existing file, or use the PIP utility.

**File exists, erase it**

ED. The destination filename already exists when you are placing the destination file on a different disk than the source. It should be erased or another disk selected to receive the output file.

**\*\* FILE IS READ/ONLY \*\***

ED. The file specified in the command to invoke ED has the Read Only attribute. ED can read the file so that the user can examine it, but ED cannot change a Read Only file.

**File Not Found**

CP/M cannot find the specified file. Check that you have entered the correct drive specification or that you have the correct disk in the drive.

ED. ED cannot find the specified file. Check that you have entered the correct drive specification or that you have the correct disk in the drive.

STAT. STAT cannot find the specified file. The message might appear if you omit the drive specification. Check to see if the correct disk is in the drive.

**FILE NOT FOUND— {filespec}**

PIP. An input file that you have specified does not exist.

**Filename required**

ED. You typed the ED command without a filename. Reenter the ED command followed by the name of the file you want to edit or create.

**hhhh??=dd**

DDT. The ?? indicates DDT does not know how to represent the hexadecimal value dd encountered at address hhhh in 8080 assembly language. dd is not an 8080 machine instruction opcode.

**Insufficient memory**

DDT. There is not enough memory to load the file specified in an R or E command.

**Invalid Assignment**

STAT. You specified an invalid drive or file assignment, or misspelled a device name. This error message might be followed by a list of the valid file assignments that can follow a filename. If an invalid drive assignment was attempted the message "Use: d:=RO" is displayed, showing the proper syntax for drive assignments.

**Invalid control character**

SUBMIT. The only valid control characters in the SUBMIT files of type SUB are ^ A through ^ Z. Note that in a SUBMIT file the control character is represented by typing the circumflex, ^, not by pressing the control key.

**INVALID DIGIT— {filespec}**

PIP. An invalid hex digit has been encountered while reading a hex file. The hex file with the invalid hex digit should be corrected, probably by recreating the hex file.

#### Invalid Disk Assignment

STAT. Might appear if you follow the drive specification with anything except =R/O.

#### INVALID DISK SELECT

CP/M received a command line specifying a nonexistent drive, or the disk in the drive is improperly formatted. CP/M terminates the current program as soon as you press any key.

#### INVALID DRIVE NAME (Use A, B, C, or D)

SYSGEN. SYSGEN recognizes only drives A, B, C and D as valid destinations for system generation.

#### Invalid File Indicator

STAT. Appears if you do not specify RO, RW, DIR, or SYS.

#### INVALID FORMAT

PIP. The format of your PIP command is illegal. See the description of the PIP command.

#### INVALID HEX DIGIT

LOAD ADDRESS hhhh  
ERROR ADDRESS hhhh  
BYTES READ:  
hhhh

LOAD. File contains incorrect hex digit.

#### INVALID MEMORY SIZE

MOVCPM. Specify a value less than 64K or your computer's actual memory size.

#### INVALID SEPARATOR

PIP. You have placed an invalid character for a separator between two input filenames.

#### INVALID USER NUMBER

PIP. You have specified a user number greater than 15. User numbers are in the range 0 to 15.

#### n?

USER. You specified a number greater than fifteen for a user area number. For example, if you type USER 18<cr>, the screen displays 18?.

#### NO DIRECTORY SPACE

ASM. The disk directory is full. Erase some files to make room for PRN and HEX files. The directory can usually hold only 64 filenames.



#### NO DIRECTORY SPACE— {filespec}

PIP. There is not enough directory space for the output file. You should either erase some unnecessary files or get another disk with more directory space and execute PIP again.

#### NO FILE— {filespec}

DIR, ERA, REN, PIP. CP/M cannot find the specified file, or no files exist.

ASM. The indicated source or include file cannot be found on the indicated drive.

DDT. The file specified in an R or E command cannot be found on the disk.

#### NO INPUT FILE PRESENT ON DISK

DUMP. The file you requested does not exist.

#### No memory

There is not enough (buffer?) memory available for loading the program specified.

#### NO SOURCE FILE ON DISK

SYSGEN. SYSGEN cannot find CP/M either in CPMxx.com form or on the system tracks of the source disk.

#### NO SOURCE FILE PRESENT

ASM. The assembler cannot find the file you specified. Either you mistyped the filespecification in your command line, or the file is not type ASM.

#### NO SPACE

SAVE. Too many files are already on the disk, or no room is left on the disk to save the information.

#### No SUB file present

SUBMIT. For SUBMIT to operate properly, you must create a file with filetype of SUB. The SUB file contains usual CP/M commands. Use one command per line.

#### NOT A CHARACTER SOURCE

PIP. The source specified in your PIP command is illegal. You have probably specified an output device as a source.

#### \*\* NOT DELETED \*\*

PIP. PIP did not delete the file, which may have had the R/O attribute.

#### NOT FOUND

PIP. PIP cannot find the specified file.

#### OUTPUT FILE WRITE ERROR

ASM. You specified a write-protected diskette as the destination for the PRN and HEX files, or the diskette has no space left. Correct the problem before assembling your program.

#### Parameter error

SUBMIT. Within the SUBMIT file of type sub, valid parameters are \$0 through \$9.

#### PARAMETER ERROR, TYPE RETURN TO IGNORE

SYSGEN. If you press return, SYSGEN proceeds without processing the invalid parameter.

#### QUIT NOT FOUND

PIP. The string argument to a Q parameter was not found in your input file.

#### Read error

TYPE. An error occurred when reading the file specified in the type command. Check the disk and try again. The STAT filespec command can diagnose trouble.

#### READER STOPPING

PIP. Reader operation interrupted.

#### Record Too Long

PIP. PIP cannot process a record longer than 128 bytes.

#### Requires CP/M 2.0 or later

XSUB. XSUB requires the facilities of CP/M 2.0 or newer version.

#### Requires CP/M 2.0 or newer for operation

PIP. This version of PIP requires the facilities of CP/M 2.0 or newer version.

#### START NOT FOUND

PIP. The string argument to an S parameter cannot be found in the source file.

#### SOURCE FILE INCOMPLETE

SYSGEN. SYSGEN cannot use your CP/M source file.

#### SOURCE FILE NAME ERROR

ASM. When you assemble a file, you cannot use the wildcard characters \* and ? in the filename. Only one file can be assembled at a time.

#### SOURCE FILE READ ERROR

ASM. The assembler cannot understand the information in the file

containing the assembly language program. Portions of another file might have been written over your assembly language file, or information was not properly saved on the diskette. Use the TYPE command to locate the error. Assembly language files contain the letters, symbols, and numbers that appear on your keyboard. If your screen displays unrecognizable output or behaves strangely, you have found where computer instructions have crept into your file.

#### SYNCHRONIZATION ERROR

MOVCPM. The MOVCPM utility is being used with the wrong CP/M system.

#### "SYSTEM" FILE NOT ACCESSIBLE

You tried to access a file set to SYS with the STAT command.

#### \*\* TOO MANY FILES \*\*

STAT. There is not enough memory for STAT to sort the files specified, or more than 512 files were specified.

#### UNEXPECTED END OF HEX FILE—{filespec}

PIP. An end-of-file was encountered prior to a termination hex record. The hex file without a termination record should be corrected, probably by recreating the hex file.

#### Unrecognized Destination

PIP. Check command line for valid destination.

#### Use: STAT d:=RO

STAT. An invalid STAT drive command was given. The only valid drive assignment in STAT is STAT d:=RO.

#### VERIFY ERROR:—{filespec}

PIP. When copying with the V option, PIP found a difference when rereading the data just written and comparing it to the data in its memory buffer. Usually this indicates a failure of either the destination disk or drive.

#### WRONG CP/M VERSION (REQUIRES 2.0)

#### XSUB ACTIVE

SUBMIT. XSUB has been invoked.

#### XSUB ALREADY PRESENT

SUBMIT. XSUB is already active in memory.

#### Your input?

If CP/M cannot find the command you specified, it returns the command name you entered followed by a question mark. Check that you have typed the command line correctly, or that the command you requested exists as a .COM file on the default or specified disk.

# INDEX

Absolute line number, 36  
Access mode, 13  
afn (ambiguous file reference), 3, 4, 6  
Allocation vector, 105  
Ambiguous file reference (afn), 3, 4, 6  
ASM, 15, 47  
Assembler, 15, 47  
Assembler/disassembler module (DDT), 77  
Assembly errors, 62  
Assembly language mnemonics in DDT, 71, 74  
Assembly language program, 49  
Assembly language statement, 49  
Automatic command processing, 25

Base, 50  
Basic Disk Operating System (BDOS), 2, 89, 127  
Basic I/O System (BIOS), 2, 89, 127  
BDOS (Basic Disk Operating System), 2, 89, 127  
Binary constants, 50  
BIOS (Basic I/O System), 2, 89, 127  
BIOS disk definition, 148  
BIOS subroutines, 137  
Block move command, 74  
bls parameter, 149  
BOOT, 90, 136, 140  
BOOT entry point, 140  
Breakpoint, 71, 73  
Built-in commands, 3

Case translation, 5, 6, 20, 21, 37, 39, 44, 45, 51, 95  
CCP (Console Command Processor), 2, 69, 89, 127  
CCP Stack, 92  
Character pointer, 35  
CKS parameter, 149  
Close File function, 101  
Code and data areas, 144  
Cold start loader, 136, 140, 143  
Combine files, 17  
Command, 3  
Command line, 90  
Comment field, 49  
Compute File Size function, 108  
Condition flags, 58, 77  
Conditional assembly, 56  
CONIN, 140  
CONOUT, 141  
CONSOLE, 138  
Console Command Processor (CCP), 2, 69, 89, 127  
Console Input function, 95  
Console Output function, 96  
CONST, 140  
Constant, 50  
Control characters, 44  
Control functions, 9

Control-Z character, 93  
Copy files, 17  
CPU state, 71  
cr (carriage return), 39  
Create files, 23  
Create system disk, 24  
Creating COM files, 16  
Currently logged disk, 3, 5, 10, 17, 25

Data allocation size, 147  
Data block number, 147  
DB statement, 57  
DDT commands, 70, 133  
DDT nucleus, 77  
DDT prompt, 70  
DDT sign-on message, 69  
Decimal constant, 50  
Default FCB, 73  
Delete File function, 102  
DESPool, 138  
Device assignment, 11  
DIR, 6  
DIR attribute, 14  
dir parameter, 149  
Direct console I/O function, 97  
Direct Memory Address, 104  
Directory, 6  
Directory code, 100, 101, 102, 103  
Disassembler, 71, 77  
Disk attributes, 11  
Disk drive name, 5  
Disk I/O functions, 99-110  
Disk parameter block, 146  
Disk parameter header, 145  
Disk parameter table, 145  
Disk statistics, 10  
Disk-to-disk copy, 18  
DISKDEF macro, 149  
Diskette format, 31  
DISKS macro, 150, 186  
Display file contents, 8  
dks parameter, 149  
DMA, 104  
DMA address, 93  
dn parameter, 149  
DPBASE, 146  
Drive characteristics, 14  
Drive select code, 94  
Drive specification, 5  
DS statement, 57  
DUMP, 27, 113  
DW statement, 57

ED, 23, 33-45, 131  
ED commands, 38, 44  
ED errors, 43  
Edit command line, 9  
8080 CPU registers, 76  
8080 registers, 51  
end-of-file, 19, 93  
END statement, 49, 54  
ENDEF macro, 150  
ENDIF statement, 56  
EQU statement, 55

ERA, 6  
 Erase files, 6  
 Error messages, 29, 43, 62, 153  
 Expression, 49  
 Extents, 13

FBASE, 89  
 FCB, 93, 94  
 FCB format, 93, 94  
 FDOS (operations), 89, 91  
 File attributes, 14  
 File compatibility, 23  
 File control block (FCB), 93, 94  
 File expansion, 128  
 File extent, 93  
 File indicators, 14  
 File names, 3  
 File reference, 3  
 File statistics, 10, 13  
 Filetype, 93  
 Find command, 39  
 fsc parameter, 149

Get ADDR (Alloc) function, 105  
 Get ADDR (Disk Parms) function, 106  
 Get Console Status, 99  
 Get I/O Byte function, 97  
 Get Read/Only Vector function, 105  
 GETSYS, 128, 134

Hexadecimal constant, 50  
 Hex files, 16, 19, 20, 47  
 HOME subroutine, 139, 141

Identifier, 49, 50  
 IF statement, 56  
 Initialized storage areas, 57  
 In-line assembly language, 71  
 Insert mode, 37  
 Insert string, 40  
 IOBYTE function, 138, 139

Jump vector, 137  
 Juxtaposition command, 41

Key fields, 109

Label field, 49  
 Labels, 48, 49, 58  
 Library read command, 42  
 Line-editing control characters, 38, 70, 98  
 Line-editing functions, 9  
 Line numbers, 36  
 LIST, 138, 141  
 List Output function, 96  
 LISTST, 142  
 LOAD, 16  
 Logged in, 3  
 Logical devices, 11, 18, 138  
 Logical extents, 93  
 Logical-physical assignments, 12, 139  
 Logical to physical device mapping, 138  
 Logical to physical sector translation, 143, 149  
 lsc parameter, 149

- Machine executable code, 16
- Macro command, 42
- Make File function, 103
- Memory buffer, 33, 34, 35, 37
- Memory image, 71, 131, 132
- Memory image file, 16
- Memory size, 27, 128, 132
- MOVCPM, 27, 131, 132
- Multiple command processing, 25

Negative bias, 132

- [o] parameter, 149
- Octal constant, 50
- ofs parameter, 150
- On-line status, 100
- Open File function, 100
- Operand field, 49-51
- Operation field, 49-58
- Operators, 52, 53, 58
- ORG directive, 54

- Page zero, 144
- Patching the CP/M system, 128
- Peripheral devices, 138
- Physical devices, 12, 18, 139
- Physical file size, 109
- Physical to logical device assignment, 12, 139
- PIP, 17
- PIP devices, 19
- PIP parameters, 20
- Print String function, 98
- PRN file, 47
- Program counter, 71, 73, 76
- Program tracing, 75
- Prompt, 3
- Pseudo-operation, 53
- PUNCH, 138, 141
- Punch Output function, 96
- PUTSYS, 129, 135

- Radix indicators, 50
- Random access, 107, 108, 117
- Random access files, 93
- Random record number, 108
- READ, 142
- Read Console Buffer function, 98
- Read only, 14
- Read/only status, 14
- Read random error codes, 107
- Read Random function, 107
- READ routine, 139
- Read Sequential function, 102
- Read/write, 14
- READER, 138, 141
- Reader Input function, 96
- REN, 7
- Rename file function, 104
- Reset Disk function, 99
- Reset Drive function, 109
- Reset state, 99
- Return Current Disk function, 104
- Return Log-in Vector function, 104
- Return Version Number function, 99
- R/O, 14

R/O attribute, 106  
 R/O bit, 105  
 R/W, 14

SAVE, 7  
 SAVE command, 70  
 Search for First function, 101  
 Search for Next function, 102  
 Search strings, 39  
 Sector allocation, 136  
 SECTRAN, 143  
 SELDSK, 139, 141, 146  
 Select Disk function, 100  
 Sequential access, 93  
 Set DMA address function, 104  
 Set File Attributes function, 106  
 Set/Get User Code function, 106  
 Set I/O Byte function, 97  
 Set Random Record function, 109  
 SET statement, 55  
 SETDMA, 142  
 SETSEC, 142  
 SETTRK, 141  
 Simple character I/O, 138  
 Size in records, 13  
 skf parameter, 149, 150  
 Source files, 93  
 Stack pointer, 92  
 STAT, 10, 139, 151  
 Stop console output, 9  
 String substitutions, 40  
 SUBMIT, 25  
 SYS attribute, 14  
 SYSGEN, 24, 134  
 System attribute, 44, 106  
 System parameters, 140  
 System (re)initialization, 138  
 System Reset function, 95

Testing and debugging of programs, 69  
 Text transfer commands, 35  
 TPA (Transient Program Area), 2, 89  
 Trace mode, 76  
 Transient commands, 3, 9  
 Transient Program Area (TPA), 2, 89  
 Translate table, 150  
 Translation vectors, 146  
 TYPE, 8

ufn, 3, 6  
 Unambiguous file reference, 3, 6  
 Uninitialized memory, 57  
 Untrace mode, 76  
 USER, 8  
 USER numbers, 8, 15, 106

Verify line numbers command, 37, 45  
 Version independent programming, 99  
 Virtual file size, 108

Warm start, 90, 140  
 WBOOT entry point, 140  
 WRITE, 142  
 Write Protect Disk function, 105  
 Write random error codes, 108



Write Random function, 108  
Write Random with Zero Fill function, 110  
WRITE routine, 142  
Write Sequential function, 103

XSOB, 26