

MODEL 630
PRINTERS/TERMINALS

HPRO5 INTERFACE

90441-01 Rev A

January 1982

DIABLO SYSTEMS, INC.

A XEROX Company

FCC NOTICE

Warning: This equipment generates, uses and can radiate radio frequency energy and, if not installed in accordance with the instructions manual, may cause interference to radio communications. Because the different versions of this device meet different emissions standards, and because the same instructions manual covers all versions, all of the different applicable warnings are set forth below with the appropriate FCC Label installed on each unit.

As temporarily permitted by regulation, this equipment has not been tested for compliance with the limits for Class A computing devices pursuant to Subpart J of Part 15 of FCC Rules, which are designed to provide reasonable protection against such interference.

This equipment has been tested and found to comply with the limits for a Class A computing device pursuant to Subpart J of Part 15 of the FCC Rules, which are designed to provide reasonable protection against such interference when this device is operated in a commercial environment.

In either of the above cases, operation of this equipment in a residential area is likely to cause interference, in which case the user, at his own expense, will be required to take whatever measures are necessary to correct the interference.

This version has been type tested and found to comply with the limits for a Class B computing device in accordance with the specifications in subpart J of Part 15 of the FCC Rules, which are designed to provide reasonable protection against such interference in a residential installation. This equipment generates and uses radio frequency energy, and if not installed and used properly in strict accordance with the manufacturer's instructions, may cause interference to radio and television reception. There is, however no guarantee that interference will not occur in a particular installation.

If equipment certified to meet the Class B limits does cause interference to radio or television reception, which can be determined by turning the equipment off and on, the user is encouraged to try to correct the interference by one or more of the following measures: (a) Reorient the receiving antenna. (b) Relocate the computer with respect to the receiver. (c) Move the computer away from the receiver. (d) Plug the computer into a different outlet so that the computer and the receiver are on different branch circuits.

If necessary, the user should consult the dealer or an experienced radio/television technician for additional suggestions. In addition, an FCC booklet, "How to Identify and Resolve Radio-TV Interference Problems", Stock No. 004-000-00345-4, is available from the U.S. Government Printing Office, Washington, D.C., 20402.

In those versions of this equipment labeled Class A or B Compliant a shielded and grounded I/O cable is necessary to achieve compliance with the FCC Rules regarding radio emissions from computers. Please consult your authorized Diablo sales representative for further details regarding the cable.

PREFACE

Diablo Systems, Inc., reserves the right to make changes and/or improvements to its products without incurring any obligation to incorporate such changes or improvements in units previously sold or shipped.

This manual describes interfacing and operating considerations pertaining to the Model 630 HPRO5 interface configuration. This is one in a family of manuals covering the Model 630 printers and terminals. For a list of related publications, refer to the Model 630 Product Description manual, Publication No. 90442-XX; or to the Model 630 Communications Terminal Operator's Guide, Publication No. 90445-XX.

Comments on all Diablo publications or their use are invited. Address your comments to:

Manager, Customer Service Publications
Diablo Systems, Incorporated
P.O. Box 5003
Hayward, California 94545

Diablo[®], HyType[®] and XEROX[®] are trademarks of XEROX CORPORATION.
HyFeed is a trademark of Diablo Systems, Incorporated.

© Copyright 1982 by Diablo Systems, Inc., Hayward, California, USA
Publication No. 90441-01 Rev A - First Edition

WARRANTY

Diablo Model 630 Printers and Terminals are warranted against defects in materials and workmanship for 90 days from the date of shipment. Any questions regarding the warranty should be directed to your Diablo Sales Representative. All requests for repair should be directed to the Diablo Service Center in your area. This will assure you of the fastest possible service.

UL/CSA

UL recognized and listed under File No. E51242.
CSA certified as a component and printer under CSA File LR2196.

(For a complete list of pertinent Standards and Regulations, refer to Section 1.5 in the Model 630 Product Description Manual, Publication No. 90442-XX.)

Printed In The USA

REVISION CONTROL RECORD

MODEL 630 HPRO5 INTERFACE MANUAL - PUBLICATION NO. 90441-01

NOTE: On revised pages of text, each area of new revision is marked by a heavy vertical bar in the margin.

<u>PAGE/REV</u>	<u>PAGE/REV</u>	<u>PAGE/REV</u>	<u>PAGE/REV</u>	<u>PAGE/REV</u>	<u>PAGE/REV</u>
Cover A	4-1 A	4-24 A	5-1 A		
ii A	4-2 A	4-25 A	5-2 A		
iii A	4-3 A	4-26 A	5-3 A		
iv A	4-4 A	4-27 A	5-4 A		
v A	4-5 A	4-28 A	5-5 A		
vi A	4-6 A	4-29 A	5-6 A		
vii A	4-7 A	4-30 A	5-7 A		
viii A	4-8 A	4-31 A	5-8 A		
1-1 A	4-9 A	4-32 A	5-9 A		
1-2 A	4-10 A	4-33 A	5-10 A		
1-3 A	4-11 A	4-34 A	5-11 A		
2-1 A	4-12 A	4-35 A	5-12 A		
2-2 A	4-13 A	4-36 A	5-13 A		
2-3 A	4-14 A	4-37 A	5-14 A		
2-4 A	4-15 A	4-38 A	5-15 A		
2-5 A	4-16 A	4-39 A	5-16 A		
3-1 A	4-17 A	4-40 A	5-17 A		
3-2 A	4-18 A	4-41 A	5-18 A		
3-3 A	4-19 A	4-42 A	5-19 A		
3-4 A	4-20 A	4-43 A	5-20 A		
3-5 A	4-21 A	4-44 A	5-21 A		
3-6 A	4-22 A	4-45 A	A-1 A		
3-7 A	4-23 A	4-46 A			
		4-47 A			
		4-48 A			
		4-49 A			

4.9.2	Standard Formats	4-16
4.9.3	Optional Formats (Variable Indexing)	4-17
4.9.4	Variable HMI	4-17
4.9.5	Variable VMI	4-17
4.9.6	Lines Per Page	4-17
4.10	Forward/Backward Printing	4-18
4.10.1	Auto Backward Printing	4-18
4.10.2	Programmed Backward Printing	4-18
4.10.3	Inverted Horizontal Motion	4-18
4.11	Print Suppression	4-19
4.12	Control Of Margins	4-19
4.13	Tabbing	4-19
4.13.1	Normal Horizontal Tab	4-20
4.13.2	Absolute Horizontal Tab	4-20
4.13.3	Normal Vertical Tab	4-20
4.13.4	Absolute Vertical Tab	4-21
4.14	Line Feed	4-21
4.15	Half Line Feed	4-21
4.16	Form Feed	4-21
4.17	Carriage Return	4-21
4.18	Auto Carriage Return	4-22
4.19	Graphics	4-22
4.20	Two-Color Printing (Optional Feature)	4-22
4.21	Reset/Initialization	4-22
4.21.1	Limited Reset	4-22
4.21.2	Initialize	4-23
4.22	Internal Diagnostics (Self-Test)	4-24
4.22.1	Confidence Test	4-24
4.22.1.1	Confidence Test On Model 630 Without Control Panel	4-25
4.22.1.2	Confidence Test With Control Panel - Without Jumper A60-1/2 on the HPRO5 PCB	4-25
4.22.1.3	Confidence Test With Control Panel - With Jumper A60-1/2 on the HPRO5 PCB	4-26
4.22.2	Individual Tests	4-27
4.23	Expanded Communications Set	4-28
4.23.1	Word Processing Enhancements	4-28
4.23.1.1	Proportional Space Printing	4-28
4.23.1.2	Offset Selection	4-29
4.23.1.3	Auto Underscore	4-29
4.23.1.4	Bold Overprint	4-30
4.23.1.5	Shadow Print	4-30
4.23.1.6	Carriage Settling Time Control	4-30
4.23.1.7	Half-Unit Backspace	4-30
4.23.1.8	Program Mode	4-30
4.23.1.9	Cancel Word Processing Options	4-32
4.23.1.10	Auto Center	4-32
4.23.1.11	Auto Justify	4-32
4.23.1.12	Line Edit (KSR only)	4-33
4.23.1.13	Margin Control (KSR only)	4-34
4.23.2	Paper Feed Accessory Support	4-34
4.23.3	Remote Diagnostics	4-34
4.23.3.1	Diagnostic Commands	4-34
4.23.3.2	Diagnostics Interface Protocol	4-34
4.23.3.3	Diagnostic Command Definitions	4-35

4.23.4	"Here Is ..." and Nonvolatile RAM Option	4-36
4.23.4.1	"Here Is ..."	4-36
4.23.4.2	Nonvolatile Parameter Memory	4-37
4.23.5	HyPLOT Vector Plotting	4-38
4.23.5.1	Scope	4-38
4.23.5.2	Definition Of Terms	4-38
4.23.5.3	Description Of HyPLOT Vector Plotting	4-39
4.23.5.4	The HyPLOT Commands	4-40
4.23.5.5	Basic HyPLOT Procedure	4-42
4.23.5.6	Summary	4-44

SECTION 5 - OPERATING REFERENCES

5.1	ASCII Coding System	5-1
5.2	Keyboards	5-2
5.3	Print Wheel Code Charts (Typical)	5-11
5.4	Decimal Value Tables	5-16
5.5	Tables For Character Proportional Space Units & Print Wheel Program Mode	5-19

APPENDIX A - LANGUAGE SELECT PRIORITY A-1

ILLUSTRATIONS

Figure

1-1	Model 630 HPRO5 TERMINALS	1-1
1-2	Model 630 HPRO5 Block Diagram	1-2
1-3	Location Of Major Circuit Boards	1-3
2-1	Interface Connector Location	2-1
2-2	EIA RS-232-C Interface Cable	2-1
2-3	Current Loop Interface Connector And Cable	2-5
3-1	HPRO5 Circuit Board Jumpers And Switches	3-1
3-2	HPRO5 Control Switch Functions	3-3
4-1	HPRO5 ROM And RAM Locations	4-1
4-2	Operator Control Panel	4-2
4-3	AC Power On-Off Switch And Line Fuse	4-6
4-4	Model 630 Keyboard Sections	4-7
4-5	Standard Keyboard Assignments	4-7
4-6	CTRL Mode Key Assignments	4-8
4-7	ESC Mode Key Assignments	4-10
4-8	Page Layout And Printing Format	4-15
4-9	Confidence Test Printout	4-25
4-10	Absolute/Relative Vector Plot Example	4-43
---	HyPLOT Example A	4-46
---	HyPLOT Example B	4-47
---	HyPLOT Worksheet	4-48
4-11	HyPLOT Flowchart	4-49
5-1	ASCII Code Chart	5-1
5-2	47-Key Typewriter Paired ASCII Keyboard	5-3
5-3	47-Key Logical Bit Paired Keyboard	5-4
5-4	47-Key APL Keyboard	5-5
5-5	47-Key French AZERTY Keyboard	5-6
5-6	47-Key Scandinavian Keyboard	5-7
5-7	47-Key German Keyboard	5-8
5-8	47-Key Norsk Keyboard	5-9

5-9	96-Character Print Wheel - Plastic	5-11
5-10	88-Character Print Wheel - Metal	5-12
5-11	92-Character Print Wheel - Metal	5-13
5-12	96-Character Print Wheel - Metal (DIABLO).	5-14
5-13	96-Character Print Wheel - Metal (RANK XEROX).	5-15
A-1	Language Select Priority Chart	A-1

TABLES

Table

2-1	EIA Interface Connector Pin Assignments	2-2
2-2	Pin-To-Pin Wiring From EIA Connector To HPR05 Circuit Board	2-3
2-3	Current Loop Cable Pin Assignments (For Model 630 <u>Passive</u> Current Loop Interface)	2-5
2-4	Current Loop Cable Pin Assignments (For Model 630 <u>Active</u> Current Loop Interface)	2-5
3-1	HPR05 Option Jumpers	3-2
3-2	Optional Baud Rate Select	3-3
3-3	Language Select	3-3
3-4	HPR05 Baud Selection	3-5
4-1	Print Wheel And Language Selection	4-14
4-2	Standard Printing Formats	4-16
4-3	ASCII Characters For Values Of h and v	4-40
4-4	Conversion - X/Y Plot Increments Of Move To Binary Equivalents	4-41
4-5	Conversion - X/Y Plot Binary Equivalents To ASCII Byte Code	4-41
4-6	ASCII/BINARY Code Chart	4-41
5-1	47-Key Typewriter Pairing Keyboard ASCII/APL Mode	5-10
5-2	Decimal Values Of ASCII Characters	5-16
5-3	ASCII Values For ESC Sequences (Set HMI, Set VMI)	5-17
5-4	ASCII Values For ESC Sequences (Set Lines/Page, Set Absolute Horizontal Tab, Set Absolute Vertical Tab)	5-18
5-5	Character Proportional Space Units - Metal Print Wheels	5-19
5-6	Character Proportional Space Units - Plastic Print Wheels	5-20
5-7	Print Wheel Program Mode - Characters For Hammer Energy And Ribbon Advance	5-21

SECTION 1

GENERAL DESCRIPTION

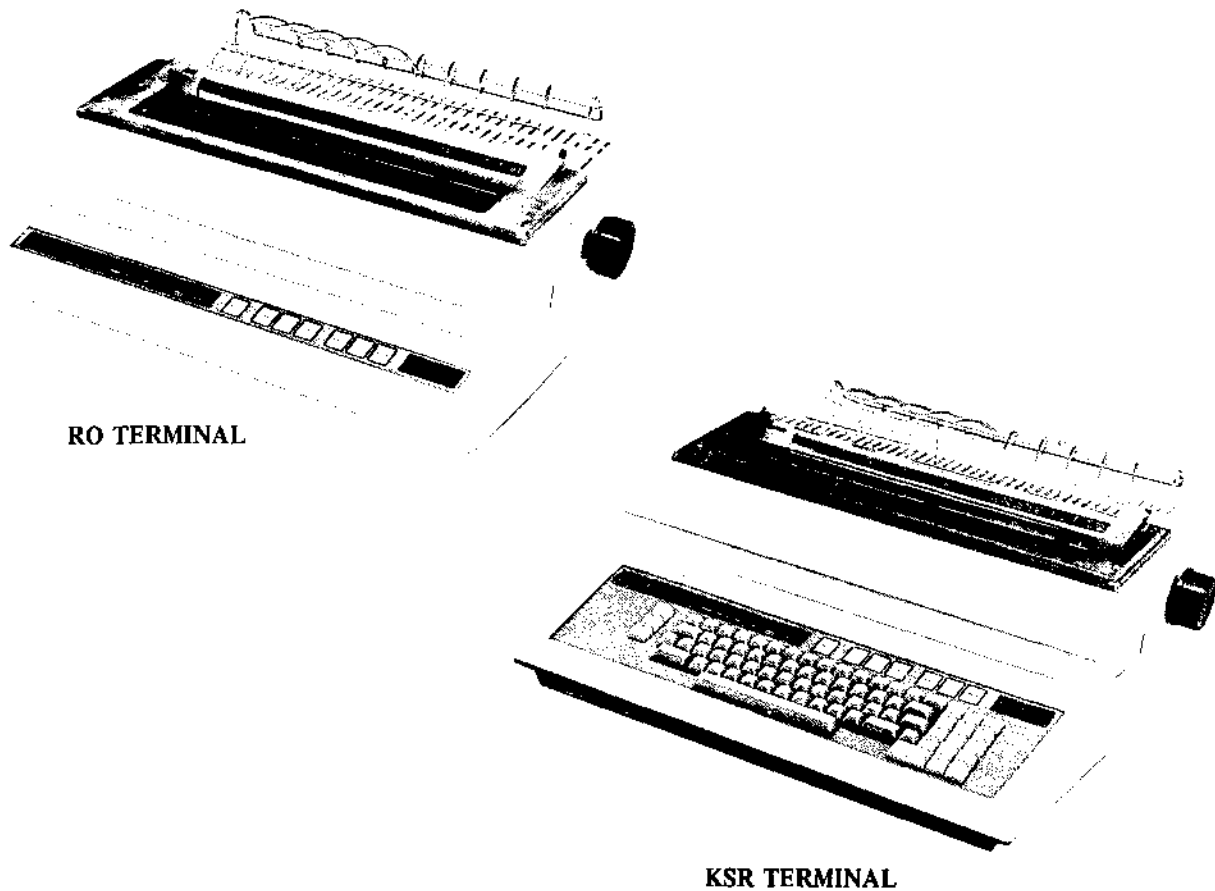

Figure 1-1. MODEL 630 HPRO5 TERMINALS

1.1 GENERAL INFORMATION

The Model 630 HPRO5 Terminals use a serial communications type interface. This interface can be configured as an EIA RS-232-C (CCITT V.24) type interface, or as a current loop interface.

The HPRO5 terminals communicate using the USA Standard Code for Information Interchange (ASCII). Each ASCII character code consists of a start bit, seven data bits, a parity bit, and one or two stop bits. At 110 baud, two stop bits are used; at all other baud rates, one stop bit is used. This conforms to the American National Standards Institute (ANSI) convention for asynchronous character transmission.

For buffer control, the HPRO5 interface will operate with both the ETX/ACK and DC1/DC3 communication protocols, either separately or simultaneously. Buffer control can also be accomplished by means of a "Printer Ready" protocol. The communication protocols are discussed in subsection 4.7 of this manual.

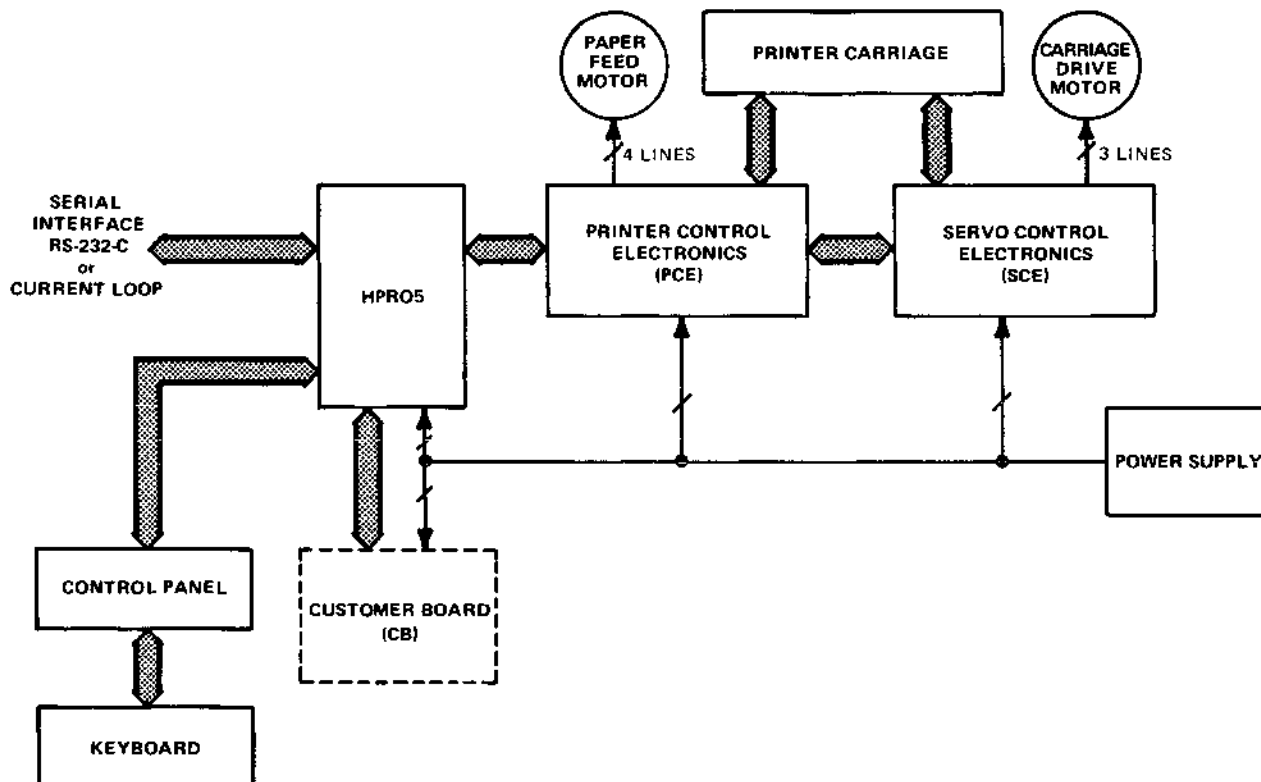

Figure 1-2. MODEL 630 HPRO5 BLOCK DIAGRAM

The Model 630 HPRO5 is depicted in block diagram form in Figure 1-2. The HPRO5 terminals contain three major circuit boards: the SCE board (Servo Control Electronics), the PCE board (Printer Control Electronics) and the HPRO5 board. The interface circuits are contained on the HPRO5 circuit board. This board receives serial ASCII data via the interface, and processes the data into suitable commands and control signals for use by the PCE circuit board. The HPRO5 circuit board also accepts data and status signals from the PCE circuit board, from the operator control panel and from the keyboard (KSR only), and converts the data and status signals into standard ASCII characters and status signals for transmission to the host computer. The HPRO5 circuit board receives data from the keyboard via the control panel.

Several characteristics and operating parameters of the HPRO5 interface are selectable by jumpers and switches on the HPRO5 circuit board, in addition to the control of operating parameters and commands provided by switches on the operator control panel.

Figure 1-3 shows the location of the three major circuit boards within the Model 630 HPRO5 terminal.

Using the RS-232-C type interface, the Model 630 is capable of communicating over leased private lines and exchange (dial) networks by connection to a Bell type 103A, 113A, 212A (or equivalent) modem. The Model 630 can also communicate through Frequency Division Multiplexed (FDM) or Time Division Multiplexed (TDM) networks, provided the equipment used presents the same characteristics as the modems listed above.

When specified for current loop use, the HPRO5 circuit board is equipped with the components that compose the current loop receiver/driver circuits. These circuit boards are strappable for either 20 ma or 60 ma current loop, and for either half- or full-duplex

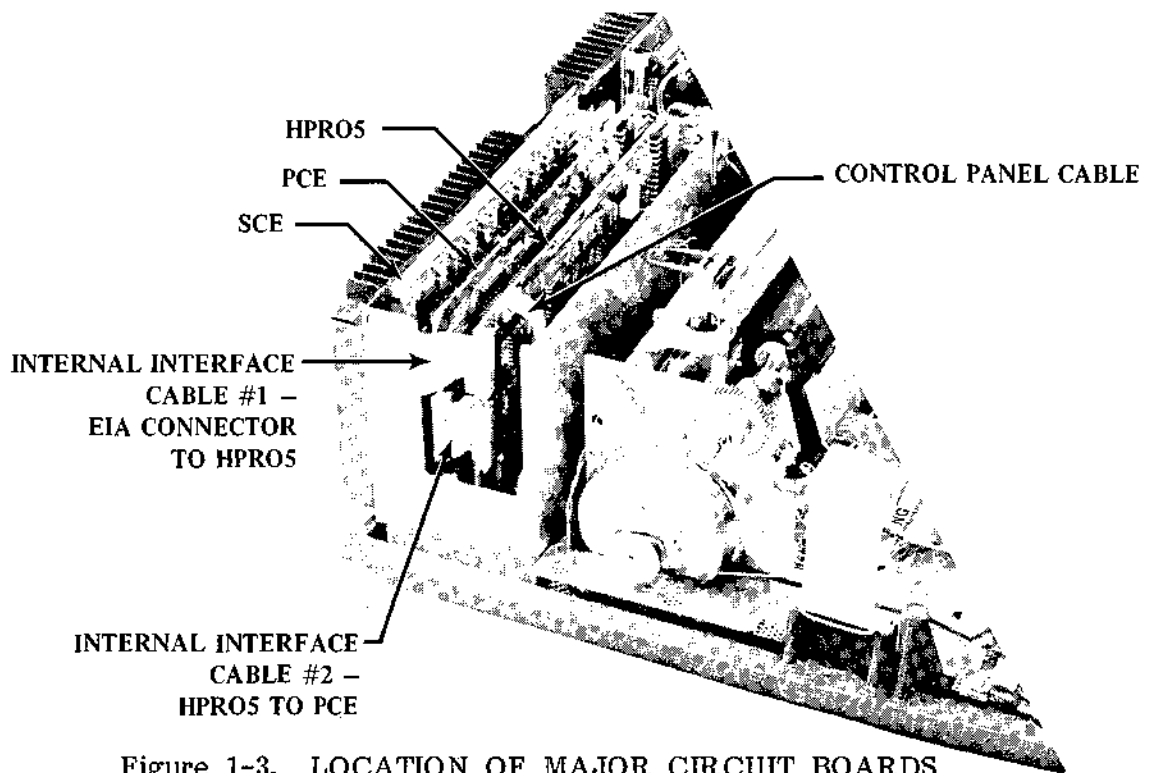

Figure 1-3. LOCATION OF MAJOR CIRCUIT BOARDS

operation. Using the current loop interface, the Model 630 is capable of direct communication over interface cables up to 4000 feet (1220 meters) in length.

Note: The current loop HPRO5 is offered on a request-for-quote basis only, and only under contract for substantial quantities. Contact your Diablo Sales Representative for further information.

1.2 SIGNAL CONVENTIONS

All signal designations used in this manual comply with the following conventions.

- 1) A signal name prefixed by a "-" symbol (as in -Rx DATA) identifies a signal whose active state is a low (LO) electrical level.
- 2) A signal name prefixed by a "+" symbol (as in +DTR) identifies a signal whose active state is a high (HI) electrical level.
- 3) Electrical levels are indicated by "HI" or "LO". HI indicates an electrical level greater than 2.4 volts. LO indicates an electrical level less than 0.8 volts.
- 4) The "true" state of a signal is indicated by a logical "1", and the "false" state by a logical "0", regardless of electrical levels. For example, -Rx DATA = 1 = LO; and +DTR = 1 = HI.



SECTION 2

INTERFACE HARDWARE AND SIGNALS

2.1 GENERAL

The information in this section pertains to the signal interface only. Information regarding power supplies, grounding requirements, ventilation and physical space requirements is contained in Section 2 of the Model 630 Product Description manual, Publication No. 90442-XX.

2.2 THE INTERFACE CONNECTOR

All versions of the Model 630 HPRO5 terminals are equipped with a 25-pin EIA connector mounted at the left-hand rear of the machine as shown in Figure 2-1.

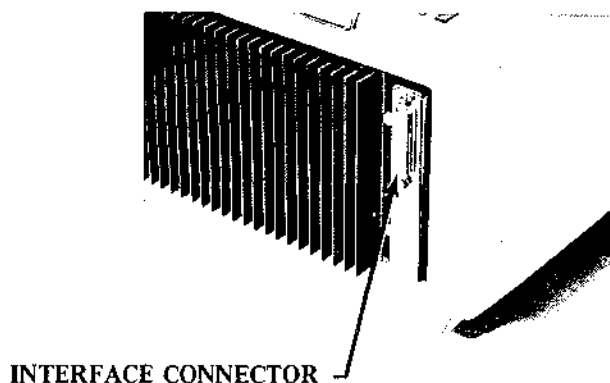

Figure 2-1. INTERFACE CONNECTOR LOCATION

2.3 RS-232-C SERIAL INTERFACE CABLE

An accessory interface cable that conforms with EIA Standard RS-232-C is available from Diablo for use with the Model 630 HPRO5. This cable is illustrated in Figure 2-2. Nominal cable length is 10 feet. The cable is terminated on both ends with a D-subminiature Cannon or Cinch DB-25P connector which mates with the connector found on most modems and with the EIA connector on the back of the Model 630. The Diablo (Xerox) part number for this cable is:

152S24160 EIA interface cable, 10 feet; shielded for FCC compliance

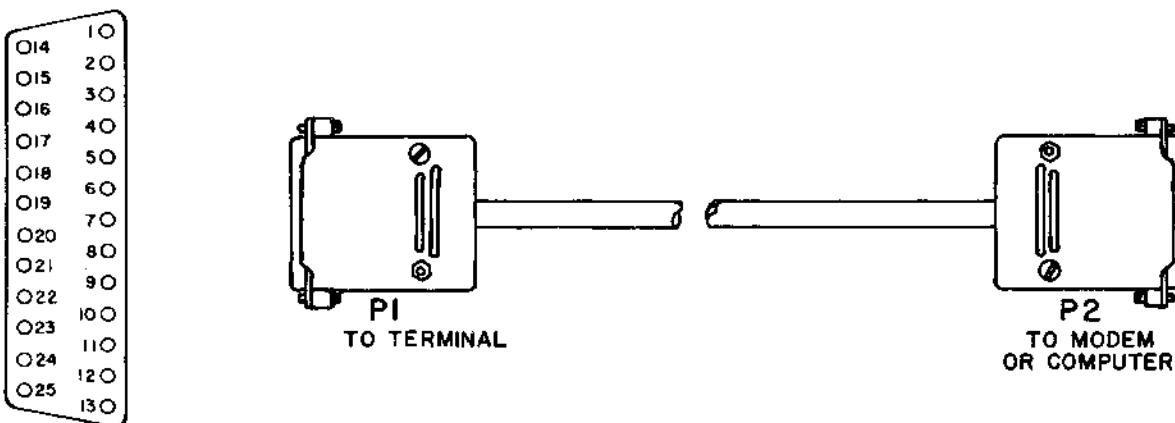

Figure 2-2. EIA RS-232-C INTERFACE CABLE

2.4 RS-232-C INPUT/OUTPUT LEVEL CONVERTER CIRCUITS

2.4.1 Input Level Converter

The Model 630's HPRO5 circuit board uses type 75154 quad line receiver integrated circuits to convert the +/-12V modem signals into +5V and 0V for use by the TTL logic in the Model 630. These circuits are capable of handling the +/-25V maximum voltage swings allowed under EIA Standard RS-232-C. Input resistance is from 3K to 7K ohms, with 5K typical.

2.4.2 Output Level Converter

Type 75150 line driver integrated circuits are used to convert the TTL levels used within the Model 630 into +/-12V levels suitable for use on the RS-232-C interface. These circuits can withstand sustained output short circuits to any low-impedance voltage within the RS-232-C range (+/-25V).

2.5 RS-232-C INTERFACE SIGNAL PIN ASSIGNMENTS

Table 2-1 lists the EIA RS-232-C interface connector pin assignments used by the HPRO5. The direction of signal flow at the interface is indicated by the arrows in the table.

Table 2-2 provides a pin-to-pin wiring list for the internal interface cable that connects the EIA interface connector to connector J4 on the HPRO5 circuit board. This internal cable is pointed out in Figure 1-3.

Table 2-1
EIA INTERFACE CONNECTOR PIN ASSIGNMENTS

Signal Direction		Pin	CCITT	TelCo	Signal
Terminal	Modem	Number			
		1	101	AA	CHASSIS GROUND
	→	2	103	BA	-TRANSMITTED DATA *
←		3	104	BB	-RECEIVED DATA *
	→	4	105	CA	+REQUEST TO SEND
←		5	106	CB	+CLEAR TO SEND
	→	6	107	CC	+DATA SET READY *
←		7	102	AB	SIGNAL GROUND
	→	8	109	CF	+CARRIER DETECT
	→	11			+PRINTER READY
	→	20	108	CD	+DATA TERMINAL READY **

Notes:

- * In those installations where the Model 630 will be cabled directly to the host system rather than thru a modem, the user must ensure the following conditions:
 1. The +DATA SET READY input must be held HI during data input to the terminal.
 2. All status conditions required by the host system must be satisfied.
 3. The transmitted data from the Model 630 must connect to the received data input of the host computer, and vice versa. In some cases, it may be necessary to alter the wiring at ONE end of the I/O cable to exchange the two wires connected to pins 2 and 3 of the I/O connector.
- ** The +PRINTER READY signal (pin 11) can also be tied to pin 20 in place of +DATA TERMINAL READY by installing a jumper plug at position A60, pins 5 and 6, on the HPRO5 circuit board.

Table 2-2
 PIN-TO-PIN WIRING FROM EIA CONNECTOR TO HPRO5 CIRCUIT BOARD
 (Functional lines only)

EIA Pin	To	HPRO5 J4 Pin	Signal Designation
1		1	CHASSIS GROUND
2		3	-TRANSMITTED DATA
3		5	-RECEIVED DATA
4		7	+REQUEST TO SEND
5		9	+CLEAR TO SEND
6		11	+DATA SET READY
7		4	SIGNAL GROUND
8		15	+CARRIER DETECT
11		21	+PRINTER READY
20		14	+DATA TERMINAL READY

2.6 RS-232-C INTERFACE SIGNAL DEFINITIONS

CHASSIS GROUND - Connects to chassis ground within the Model 630.

-TRANSMITTED DATA - This is the serial ASCII-coded digital data being transmitted by the Model 630. This signal is in the "mark" state (LO) between characters, rises for logic 0 and drops for logic 1.

-RECEIVED DATA - This is the serial ASCII-coded digital data being received by the Model 630. This signal must be held in the "mark" state (LO) between characters. It should go HI for logic 0, and LO for logic 1.

+REQUEST TO SEND - Held HI (+12V) whenever power is ON.

+CLEAR TO SEND - (Presently unused)

+DATA SET READY - Must be ON (HI) for Model 630 operation in Remote mode. If OFF (LO), no data can be received. (Also see "Notes" for Table 2-1.)

SIGNAL GROUND - Ground reference for all interface signals.

+CARRIER DETECT - The ON state of this signal is presented to the Model 630 when the data communication equipment (DCE) is receiving a carrier signal suitable for demodulation. The OFF state indicates that no signal is being received by the DCE, or that the received signal is unsuitable for demodulation. (Note: In its present design, the Model 630 ignores the CARRIER DETECT input signal.)

+PRINTER READY - Goes LO if any of the following conditions occur:

- Print Buffer nearly full (within 64 characters)
- Cover Open
- Paper Out *
- End of Ribbon *

(continued)

- Printer in CHECK
- Local Mode (KSR only)
- Pause switch depressed

* With Paper Out or End of Ribbon, +PRINTER READY goes LO only if printing is attempted.

+PRINTER READY returns HI when the buffer becomes nearly empty, and/or all other conditions have been corrected. This signal can also be applied to pin 20 of the I/O connector by installing jumper A60-5/6 on the HPRO5 circuit board.

+DATA TERMINAL READY - Without jumper A60-5/6 installed, this signal is ON (HI) whenever power is ON in the Model 630. With jumper A60-5/6 installed, this interface line (pin 20) carries the +PRINTER READY signal.

2.7 CURRENT LOOP INTERFACE - ELECTRICAL CHARACTERISTICS

(Note: The HPRO5 current loop interface is available only under contract for substantial quantities.)

The current loop interface of the Model 630 is compatible with either a 2-wire (half-duplex) or 4-wire (full-duplex) system up to a length of 4000 feet. A "mark", or logic 1, is represented by current flow (20 mA to 60 mA), and a "space", or logic 0, is represented by the absence of current flow (2 mA or less). The passive load impedance must be less than 400 ohms. Since this includes the load of the cable loop resistance which, at 4000 feet and 22 gauge is 120 ohms, the impedance of a peripheral device should not exceed 280 ohms. The active load impedance must be in excess of 4K ohms. Therefore, a peripheral device which has to modulate the current should switch its impedance levels below 400 ohms (for a mark) and above 4000 ohms (for a space). Line voltage must not exceed 10 VDC.

2.8 CURRENT LOOP INTERFACE CABLES

Two accessory current loop interface cables are available from Diablo for use with the Model 630. One of these cables is used when the Model 630 is configured as the active element in the current loop, and the other is used if the Model 630 is configured as the passive element. (Note: The cable used for passive current loop is the same as that used for the RS-232-C type interface.)

The internal wiring of these cable assemblies is arranged to adapt the Model 630 current loop interface to the same pin assignments used by Diablo Model 1640/1650 terminals operating in current loop configuration. Tables 2-3 and 2-4 define the pin assignments at both ends of the current loop interface cables.

The following cable parameters are listed for users who may prefer to supply their own current loop interface cable.

- Cable - For Half-Duplex Operation: One twisted pair of wires.
- For Full-Duplex Operation: Two twisted pairs of wires.
- Minimum 22 AWG. EIA cable recommended is Diablo P/N 10904-05.
- Maximum cable length tested is 4000 feet (1220 meters).

- Connector Parts -
 Body - Diablo P/N 10936-25
 Housing - Diablo P/N 10947
 Contacts - Diablo P/N 10939-01

This is a D-subminiature Cannon or Cinch DB-25P connector which mates with the I/O connector mounted at the rear of the Model 630.

2.9 CURRENT LOOP INTERFACE SIGNALS AND PIN ASSIGNMENTS

Figure 2-3 illustrates the pin arrangement of a current loop interface cable connector. Tables 2-3 and 2-4 identify the wiring arrangements of Diablo's current loop interface cables for the Model 630. In both tables, asterisks (*) mark the four signals which typically comprise a basic full-duplex current loop communications link.

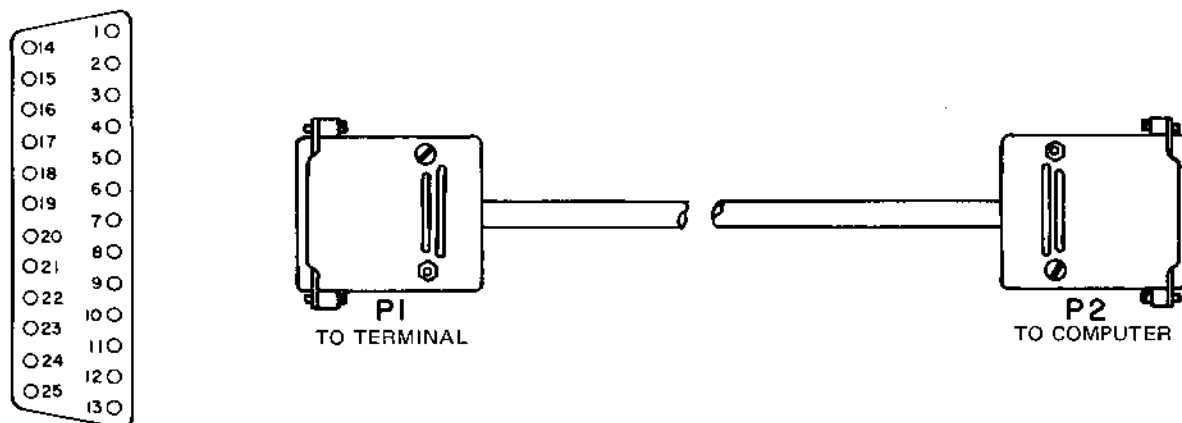

Figure 2-3. CURRENT LOOP INTERFACE CONNECTOR AND CABLE

Table 2-3
 CURRENT LOOP CABLE PIN ASSIGNMENTS
 (For Model 630 Passive Current Loop Interface)

From	To	Signal
P1-7	P2-7	XMIT SINK (GND)
P1-10	P2-17	+RECEIVE DATA* (RCV A)
P1-13	P2-13	RECEIVE SINK (GND)
P1-17	P2-18	XMIT SOURCE
P1-18	P2-24	+XMIT DATA* (XMIT B)
P1-19	P2-10	-XMIT DATA* (XMIT A) (RTN)
P1-21	P2-16	-RECEIVE DATA* (RCV B) (RTN)
P1-23	P2-23	RECEIVE SOURCE

Table 2-4
 CURRENT LOOP CABLE PIN ASSIGNMENTS
 (For Model 630 Active Current Loop Interface)

From	To	Signal
P1-7	P2-24	XMIT SINK (GND)
P1-13	P2-17	RECEIVE SINK (GND)
P1-17	P2-18	XMIT SOURCE*
P1-19	P2-10	-XMIT DATA* (XMIT A) (RTN)
P1-21	P2-16	-RECEIVE DATA* (RCV B) (RTN)
P1-23	P2-23	RECEIVE SOURCE*



SECTION 3

INTERNAL JUMPERS AND SWITCHES

3.1 HPRO5 CIRCUIT BOARD JUMPERS AND SWITCHES

The HPRO5 circuit board contains several jumper positions and switches for selecting the semi-permanent operating parameters of the terminal. Figure 3-1 shows their locations on the HPRO5 circuit board.

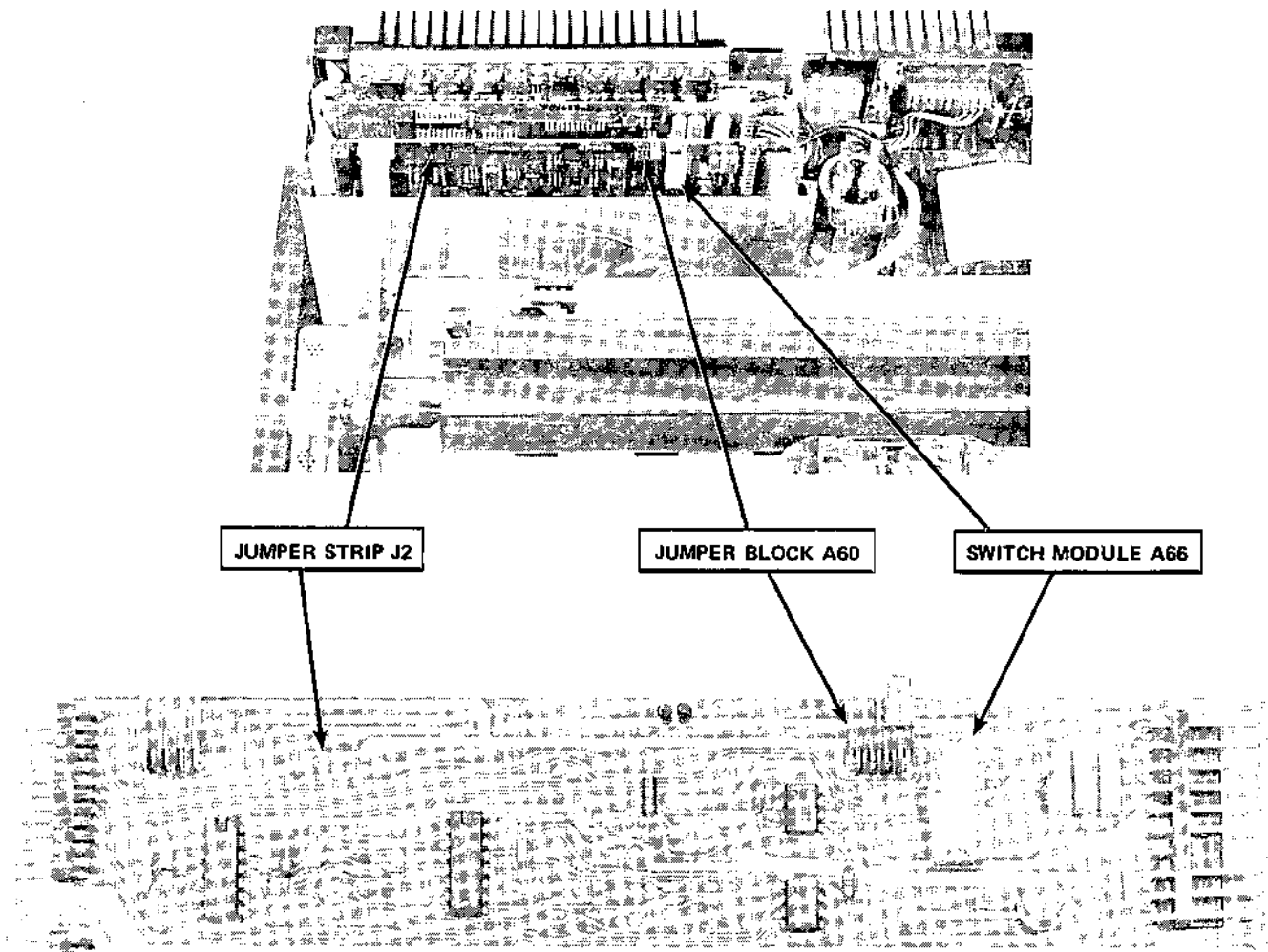

Figure 3-1. HPRO5 CIRCUIT BOARD JUMPERS AND SWITCHES

3.1.1 HPRO5 Option Jumpers

Two different types of jumpers may be found on the board: 1) a "wire jumper", which is simply a plain piece of wire soldered between two designated points on the board, and 2) a "jumper plug" which is plugged onto the pins of a jumper block to connect two of the pins directly together. In Figure 3-1 for example, jumper strip J2 is the type of arrangement that requires a wire jumper, while jumper block A60 accepts jumper plugs. In an arrangement where several jumper positions are grouped together like this, each jump point is identified by number (1, 2, 3, etc.). Individual jumpers then are identified by their location and the numbers of the two points being tied together. "A60-5/6", for example, specifies a jumper installed between pins 5 and 6 of jumper block A60.

Replacement or additional jumper plugs are available through Diablo as Diablo part number 100398-01. In lieu of jumper plugs, a suitable jumper can also be formed by wire wrap connection or by a soldered wire.

The function of some of these internal jumpers and switches varies depending on whether the unit is equipped with a control panel. Although the "standard" version of the Model 630 HPRO5 does have a control panel, there may be exceptions, and thus the jumper and switch functions both with and without control panel are described in the following subsections.

Table 3-1 outlines the functions of the option jumpers on the HPRO5 circuit board.

Table 3-1
HPRO5 OPTION JUMPERS

<u>Jumper</u>	<u>In/Out</u>	<u>Function - With Control Panel</u>
J2-9/10	In	Selects 12-inch page size (72 lines/page). <u>Note:</u> If the Model 630 is equipped with nonvolatile RAM, a Remote Reset (ESC CR P) must clear the RAM of the old 11-inch page size value.
	Out	Selects 11-inch page size (66 lines/page).
A60-1/2	In	Enables individual test selection in self-test mode, and disables automatic error retries (8).
	Out	Enables only Overall Printer Confidence Test in self-test mode.
A60-3/4	In	Enables programming the "Here Is . . ." message. (Expanded HPRO5 only.)
	Out	Protects the resident "Here is . . ." message from changes.
A60-5/6	In	Causes the +PRINTER READY interface signal to be applied to the Data Terminal Ready interface line.
	Out	Causes the Data Terminal Ready interface line to be held at a HI level whenever power is applied to the Model 630.
A60-7,8,9,10		These positions are associated with the type of (E)ROMs used and are factory matched to the board configuration. See "NOTES" on the HPRO5 schematic in the Model 630 Maintenance Manual.
<u>Function - Without Control Panel</u>		
J2-9/10	In	Disables retries on any Error condition.
	Out	Enables automatic error reset with 8 retries on any Check condition. (An automatic error reset is equivalent to a Limited Reset operation - subsection 4.21.1.)
A60-1/2	In	Conditions the Model 630 to use a metal print wheel.
	Out	Conditions the Model 630 to use a plastic print wheel.
A60-3/4		(Same as With Control Panel - see above.)
A60-5/6		(Same as With Control Panel - see above.)
A60-7,8,9,10		(Same as With Control Panel - see above.)

3.1.2 HPRO5 Control Switch Functions

This group of eight switches is contained in a switch module at location A66 on the HPRO5 circuit board (see Fig. 3-1). These switches are normally sampled only during the initialize routine that occurs at power-up. Changing the switch settings while power is ON will not change the machine parameters unless the machine receives a reset command (ESC CR P) via the communications interface or from the keyboard. Otherwise, power to the Model 630 must be switched OFF and then back ON for the switches to be read. The function of each switch is identified in Figure 3-2, and described in the paragraphs that follow.

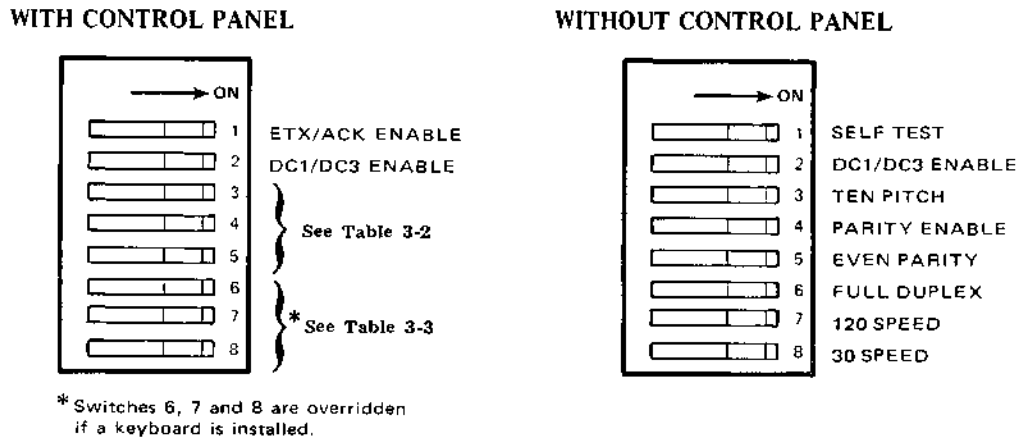

Figure 3-2. HPRO5 CONTROL SWITCH FUNCTIONS

Table 3-2
OPTIONAL BAUD RATE SELECT

SWITCH			BAUD
3	4	5	
OFF	OFF	OFF	150
ON	OFF	OFF	600
OFF	ON	OFF	1800
ON	ON	OFF	2000
OFF	OFF	ON	2400
ON	OFF	ON	4800
OFF	ON	ON	7200
ON	ON	ON	9600

Table 3-3
LANGUAGE SELECT

SWITCH			PRINT WHEEL SELECT
6	7	8	
OFF	OFF	OFF	DEFAULT TWP**
ON	OFF	OFF	TWP**
OFF	ON	OFF	LOGICAL BIT PAIRED
ON	ON	OFF	APL
OFF	OFF	ON	FRENCH AZERTY
ON	OFF	ON	GERMAN
OFF	ON	ON	SCANDINAVIAN
ON	ON	ON	NORSK

**TWP = "Typewriter Paired"

3.1.2.1 HPRO5 Control Switch Functions - Units With Control Panel

- Switch 1 - ETX/ACK - When this switch is ON, an ACK character will be transmitted whenever an ETX character is encountered in the print buffer. ETX characters are not printed. When the switch is OFF, ETX's are ignored.
- Switch 2 - DC1/DC3 (XON/XOFF) - When this switch is ON, a DC3 code will be transmitted thru the interface when any of the following conditions occur:
 - a) Print Buffer Nearly Full (within 64 characters of full)
 - b) Cover Open

(continued)

- c) Paper Out *
- d) End Of Ribbon *
- e) Printer in Check condition
- f) Pause switch has been depressed

* With paper out or end of ribbon, DC3 is sent only when printing is attempted.

Once a DC3 code has been transmitted, a DC1 code will be transmitted when the print buffer has been emptied down to within 64 characters of empty, and/or the items b) thru f) causing the alarm have been corrected and a RESET routine executed.

Switches 3, 4, 5 - These three switches select an optional baud rate as defined by Table 3-2. When the two BAUD switches on the operator control panel are set to OFF, this optional baud rate is selected as the data communication speed.

NOTE: To prevent print buffer overflow, when operating at rates above 300 baud, the system must use DC1/DC3 or ETX/ACK protocol, or must monitor and respond to the Printer Ready interface line.

Switches 6, 7, 8 - In units equipped with a control panel, these switches condition the Model 630 to recognize a particular language font for data being received thru the communications interface (see Table 3-3). These switches are enabled only when the Model 630 is equipped with a control panel but no keyboard. If a keyboard is present, the keyboard configuration determines language font selection (see subsection 5.2). Language font selection, whether by these three switches or by keyboard configuration, can be temporarily overridden by the ESC control code sequence ESC SYN (n). See subsection 4.8 for tables of (n).

3.1.2.2 HPRO5 Control Switch Functions - Units Without Operator Control Panel

- Switch 1 - Self Test - If this switch is ON at AC power up, the printer enters a self-test mode in which it repeatedly executes Test X7, described in subsection 4.22, Self-Test.
- Switch 2 - DC1/DC3 - (Functions the same, with or without the control panel - see Switch 2 above.)
- Switch 3 - Pitch - This switch controls the number of columns in the print line, and thereby the character spacing of the printout. The switch in ON for 10 Pitch (10 characters per inch), and OFF for 12 Pitch (12 characters per inch). The setting of this switch is sensed only during a power-on or controller-initiated remote RESET routine. This switch is not functional in the self-test mode (self-test printout is at 10 pitch).
- Switch 4 - Parity Enable - This switch enables parity checking and parity transmission when ON.
- Switch 5 - Parity Select - This switch is used in conjunction with the Parity Enable switch to select either Odd or Even parity when the Parity Enable switch is ON; or to select Mark or Space when the Parity Enable switch is OFF. This relationship is summarized below.

<u>Parity Enable Switch</u>	<u>Parity Select Switch</u>	<u>Selection</u>
ON	OFF	Odd parity
ON	ON	Even parity
OFF	OFF	Mark
OFF	ON	Space

When "Mark" is selected, the parity bit of transmitted characters is always a Mark (binary 1). When "Space" is selected, the parity bit is always a Space (binary 0).

- Switch 6 - Duplex - This switch selects half-duplex operation when OFF, or full-duplex operation when ON, in ASCII mode only.
- Switch 7 - 120 Speed -
- Switch 8 - 30 Speed - These two switches are used to select the speed at which data will be received and transmitted. See Table 3-4.

NOTE: To prevent print buffer overflow, the system should use DC1/DC3 or ETX/ACK protocol, or must monitor and respond to the Printer Ready interface line.

Table 3-4
HPRO5 BAUD SELECTION
(Without Control Panel)

<u>Switch</u>		<u>Baud Rate</u>
<u>8</u>	<u>7</u>	
ON	ON	110 Baud
ON	OFF	300 Baud
OFF	OFF	600 Baud
OFF	ON	1200 Baud

3.2 PCE CIRCUIT BOARD JUMPERS

There are two option jumper positions on current versions of the PCE circuit board, and on some versions there are none.

3.2.1 PCE Circuit Board Identification

To determine whether a PCE circuit board is equipped with the jumper selectable options, it is necessary to determine the design level of the circuit board. Each board displays two identifying part numbers which are etched on the circuit board.

- 302661-XX - This is the part number of the blank board, without components. This number is etched on the solder side of the board. The -XX portion of the number is called the "etch" number of the board, and indicates the design level of the board layout. There is also a "Rev" letter silk-screened onto the circuit board near the etch number. The Rev letter indicates the design revision level of circuit boards with that etch number.

302660-XX - This is the part number of the circuit board assembly with components installed. This number is etched on the component side of the board. (In some cases it may be silk-screened onto the board.) The -XX portion of this number, along with its associated Rev letter, indicates the design level of the circuit board assembly.

3.2.2 1mS RTC Option (+5V or Ground)

This option jumper selects either 0 volts (ground) or +5 volts as the electrical potential of the return line for the 1mS RTC (Real-Time Clock) signal. This jumper position is provided on PCE circuit board assemblies 302660-02 revision level J and higher, and on all board assemblies 302660-03 (all board etches 302661-06 and higher). This is a wire jumper connected between points B4 and B6 for +5V, or between points B4 and B5 for ground potential.

3.2.3 VDE Cover Open Option

This option satisfies VDE requirements for safeguarding the operator by removing servo power in the situation where the Model 630's access cover is mistakenly opened while the printer is active.

The VDE feature can be enabled only in units equipped with both a PCE circuit board at design level 302660-03 or higher, and an HPRO5 circuit board equipped with base firmware that is at the design levels listed below.

On the PCE board, the UPI firmware must be at or above the following design levels:

<u>PCE Location</u>	<u>UPI</u>	<u>Part No.</u>
C37	CAR	302994-03 (EPROM); or 302995-03 (Masked ROM)
D37	PW	302996-02 (EPROM); or 302997-02 (Masked ROM)

On the HPRO5 circuit board, the base firmware must be at or above the following design levels:

<u>HPRO5 Location</u>	<u>Firmware Part No.</u>
F4	100521-01 (EROM); or 302836-03 (Masked ROM)
F13	100522-01 (EROM); or 302837-03 (Masked ROM)

When the conditions stated above are present, jumper positions D17 and D18 on the PCE circuit board serve the following functions:

Jumper Combination

<u>D18</u>	<u>D17</u>	
OUT	IN	Enables Cover Open response appropriate to satisfy VDE regulations regarding such a condition.
IN	OUT	Disables VDE cover open response.

The resultant behavior of the Model 630 both with the VDE feature enabled, and with it disabled, is described below.

3.2.3.1 VDE Feature Enabled

When the Model 630's access cover is to be removed, the proper procedure is for the operator to first press the Pause switch on the control panel (see Fig. 4-2), and wait for all printer activity to stop before opening the cover. When the cover has been replaced, and the Reset switch is pressed, a Restore operation occurs and the printer resumes activity from where it stopped when the Pause switch was pressed.

If the access cover is opened without first pressing the Pause switch, the printer servos are immediately disabled regardless of whether the printer is idle or active. This response ensures the safety of the operator, but also usually results in the loss of one or two characters of data if printing was actually taking place when the servos disabled. After the cover is replaced and the Reset switch is pressed, a Restore operation will occur and the printer will resume activity generally from the point where it was interrupted. There may, however, have been data loss.

3.2.3.2 VDE Feature Disabled

With the VDE feature disabled, the printer responds the same to both pressing of the Pause switch and opening of the access cover. When either of these actions occurs, the printer completes any operation in progress (carriage move, paper feed, hammer fire, etc.) and then disables the servos and holds them detented. When the cover is replaced and the Reset switch is pressed, the printer resumes activity where it stopped, with no loss of data. Although no loss of data occurs if the access cover is opened without first pressing the Pause switch when the VDE feature is disabled, this procedure can momentarily expose the operator to moving printer mechanism, and thus is considered improper procedure.

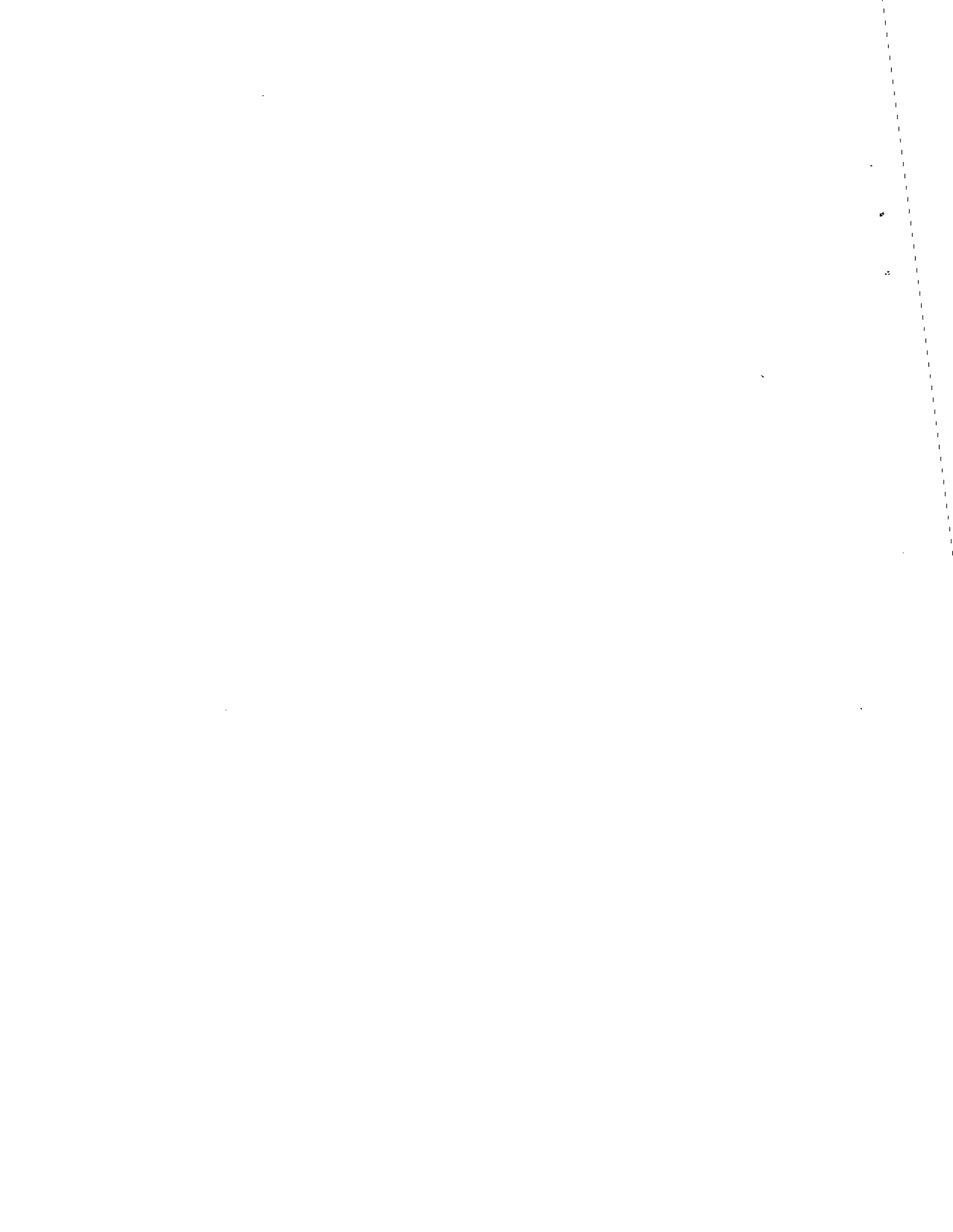

SECTION 4

OPERATING CONSIDERATIONS

4.1 GENERAL

This section of the manual contains a detailed discussion of the operating features of the of the Model 630 HPRO5 terminals. The procedures for routine operator duties, such as changing ribbons and print wheels, are given in detail in the Model 630 Operator's Guide and thus are not repeated here.

There are three standard versions of the Model 630 HPRO5 Terminal:

<u>Marketing Designation*</u>	<u>Model 630 Version</u>
HPRO5-01	HPRO5 Basic
HPRO5-02	HPRO5 Expanded
HPRO5-11	HPRO5 Word Processor

* These numbers are a Marketing designation only and should not be confused with part number designations for the HPRO5 circuit board and its associated firmware.

The features common to all three of these versions are covered first, followed by a discussion of the additional features present only in the Expanded and Word Processor versions, starting at subsection 4.23. The Word Processor version has all of the features of the Expanded version except for Nonvolatile Memory and the "Here is . . ." message capability.

The feature differences between the three versions of the HPRO5 terminal are primarily a function of the firmware installed on the HPRO5 circuit board, in the form of programmed ROM (Read-Only Memory) devices and a nonvolatile RAM. Figure 4-1 identifies all of the ROM and RAM device locations on the HPRO5 circuit board. Note that two of the ROMs comprise the Base Program firmware, and the other two ROMs comprise the Options Program firmware.

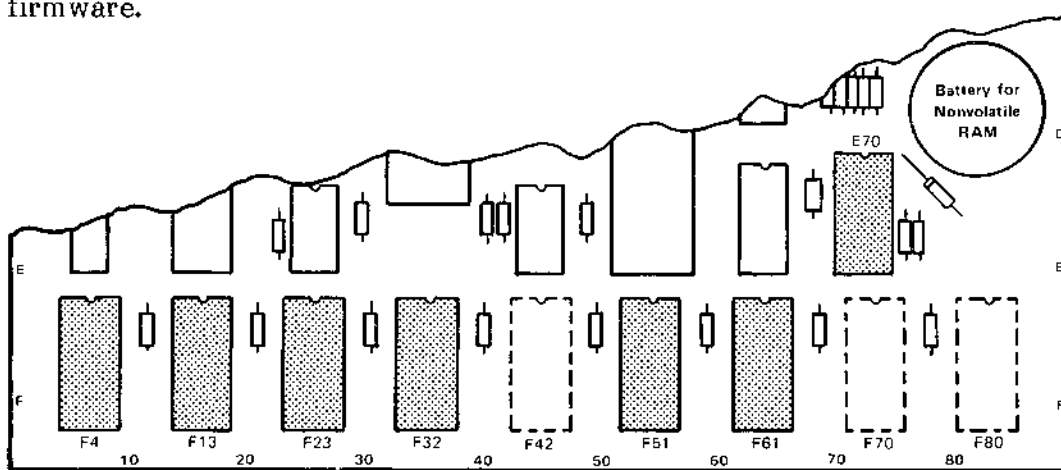

- F4, F13 = Base Firmware ROMs; all versions
- F23, F32 = Options Firmware ROMs; Expanded and WP versions only
- F51 = RAM; all versions
- F61 = Additional RAM; Expanded and WP versions
- E70 = Nonvolatile RAM; Expanded version only
- F42, F70, F80 = Unused RAM positions

Figure 4-1. HPRO5 ROM AND RAM LOCATIONS

The Expanded HPRO5 is available as either a Receive-Only (RO) terminal or Keyboard Send-Receive (KSR) terminal. Functionally, the RO and KSR are nearly identical except for the obvious additional capabilities furnished by the keyboard of the KSR.

4.2 OPERATOR CONTROL PANEL

The layout of the switches and indicators on the Operator Control Panel is shown in Figure 4-2. The function of each of these elements is defined in the paragraphs that follow.

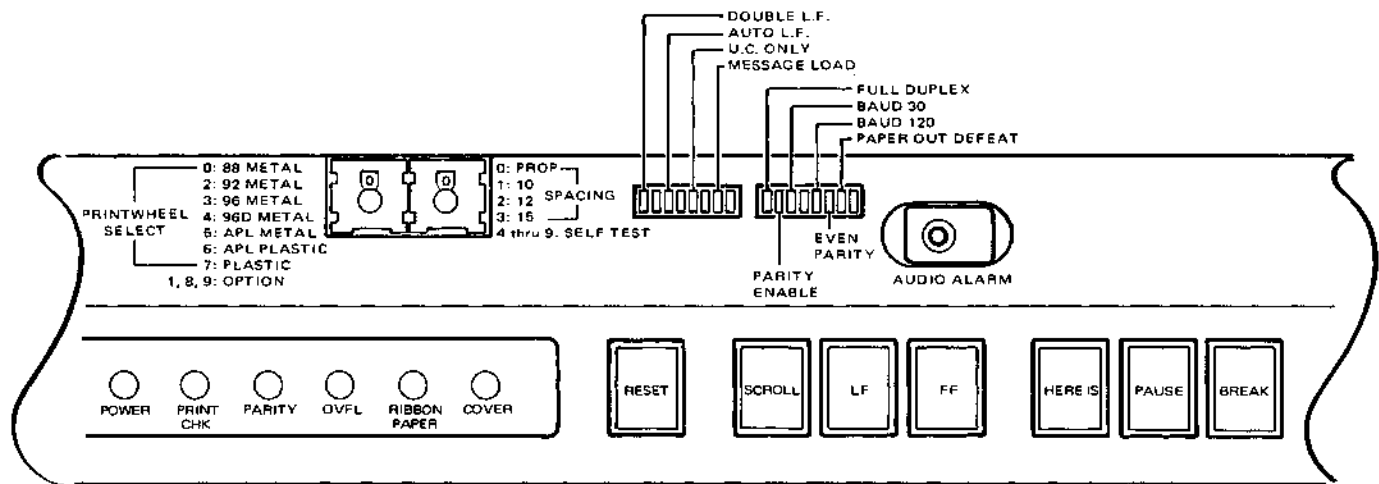

Figure 4-2. OPERATOR CONTROL PANEL

4.2.1 The Mode Switches

The mode switches are located beneath the terminal's access cover. This group of switches is comprised of two rotary switches and two switch modules containing eight slide switches each.

- Print Wheel Select

Note: To prevent possible print wheel damage or excessive wear, this switch must be set to match the type of print wheel being used.

<u>Position</u>	<u>Selection</u>
0	88-character metal wheels - Xerox
2	92-character metal wheels - Rank Xerox
3	96-character metal wheels - Rank Xerox
4	96-character metal wheels - Diablo
5	APL metal wheels
6	APL plastic wheels
7	96-character plastic wheels
1,8,9	(Selection defaults to 88-character metal wheel - same as position 0)

In addition to its function described here, the Print Wheel Select switch serves an alternate function in the Self-Test mode (see subsection 4.22.2).

- SPACING Select Switch

This switch selects the horizontal spacing for character printout, or selects self-test mode. This switch also serves an alternate function in the Internal Diagnostics mode (see subsection 4.22).

<u>Position</u>	<u>Selection</u>
0	Proportional spacing
1	10-pitch spacing
2	12-pitch spacing
3	15-pitch spacing
4 - 9	Self-Test (The terminal enters the internal diagnostics mode if this setting is selected <u>at power-on</u> ; see subsection 4.22.)

- Left-Hand Slide Switch Module

Switch 1 - DOUBLE L.F. ("Double Line Feed")

ON - Gives double line feed on every line feed command, and on every carriage return if switch 3 is ON.

OFF - Gives single line feed on every line feed command, and on every carriage return if switch 3 is ON.

Switch 3 - AUTO L.F. ("Auto Line Feed")

ON - Gives automatic line feed (single or double) on every carriage return.

OFF - No line feed on carriage return. Line feed occurs only on separate line feed command.

Switch 5 - U.C. ONLY ("Uppercase Only")

ON - Converts all lowercase alpha characters (a - z) entered from the keyboard to uppercase.

OFF - Both uppercase and lowercase character selection, by means of the shift key.

Switch 7 - MESSAGE LOAD

ON - Enables keyboard entry of "Here is . . ." message into nonvolatile memory. (Functional only in Expanded terminal with jumper A60-3/4 installed on HPRO5 circuit board.)

Switches 2,4,6,8 - (Unused on left-hand slide switch module)

- Right-Hand Slide Switch Module

Switch 1 - FULL DUPLEX

ON - Model 630 operates in full-duplex ASCII mode.

OFF - Model 630 operates in half-duplex ASCII mode.

Switch 2 - PARITY ENABLE

ON - Enables parity checking and parity transmission.

Switch 3,5	<u>BAUD</u>	<u>Switch</u>		<u>Baud Rate Selected</u>	
		30	120		
		ON	ON		110
		ON	OFF		300
		OFF	ON		1200
		OFF	OFF	At this setting, the Model 630 operates at the baud rate selected by switches 3, 4 and 5 on the HPRO5 circuit board. (See Table 3-2.)	

Switch 6 - EVEN PARITY
 This switch is used in conjunction with the Parity Enable switch to select either Odd or Even parity when the Parity Enable switch is ON; or to select Mark or Space when the Parity Enable switch is OFF. This relationship is summarized below.

<u>Parity Enable Switch</u>	<u>Parity Select Switch</u>	<u>Selection</u>
ON	OFF	Odd parity
ON	ON	Even parity
OFF	OFF	Mark
OFF	ON	Space

When "Mark" is selected, the parity bit of transmitted characters is always a Mark (binary 1). When "Space" is selected, the parity bit is always a Space (binary 0).

Switch 7 - PAPER OUT DEFEAT
 ON - Paper Out sensing ignored.

Switches 4,8 - (Unused on the right-hand slide switch module.)

4.2.2 The Operating Switches

These seven switches are located in the right-hand area of the control panel, openly accessible to the operator with all covers on the machine. These are membrane type, momentary-action switches, actuated by finger touch.

RESET Switch -

Restores the machine to normal operating status following a printer check condition. Clears all error indicators. Without a control panel, the reset function is automatic, with a limit of 8 consecutive automatic restore attempts. This switch also restarts the unit after the PAUSE switch interrupts operation.

SCROLL Switch -

Advances the paper a small amount to give the operator a clear view of the last printed line. Before printing resumes, the paper is automatically returned to the last printing position.

LF Switch -

Initiates a single or double line feed, as selected by the DOUBLE L.F. mode switch. The line feed will be repeated if the switch is held depressed longer than 600 msec. It does not cause a line feed code to be transmitted.

FF Switch -

Initiates a form feed to the next top-of-form position, without transmitting a form feed code.

HERE IS Switch -

Causes a special "Here Is . . ." message of up to 31 characters to be transmitted over the communications link when operating in remote ASCII mode with the Here Is option installed. The Here Is message resides in the Expanded terminal's nonvolatile memory.

PAUSE Switch -

The PAUSE switch, located next to the BREAK switch, is unmarked in some units. This switch allows the operator to interrupt printer operation without loss of data.

(Note: The Pause function is present only in units equipped with VDE features; see subsection 3.2.3.)

When the PAUSE switch is pressed, the Printer Ready interface signal goes false, and a DC3 character is transmitted if DC1/DC3 is enabled. Any command in process will be completed but no new commands will be dequeued from the print buffer. No commands will be lost as long as communication protocols (ETX/ACK - DC1/DC3) are observed. The Pause mode causes the PRINT CHK light to blink. Printer operation resumes when the RESET switch is pressed if all error conditions are cleared.

BREAK Switch -

Causes a Break (250 msec space) to be transmitted over the communications link when operating in remote mode. Whenever the BREAK switch is depressed or a Break is detected in the remote mode, the print buffers are emptied. Also, black ribbon and forward printing modes are established.

4.2.3 The Front Panel Indicators

4.2.3.1 Audio Alarm

This device sounds briefly to indicate the occurrence of various errors or operating conditions. All error conditions cause the alarm to sound for 1/2 second when the error is first detected. The alarm will not sound again for that error until the RESET key is depressed, clearing the error. The alarm also sounds briefly each time one of the control panel operating switches is pressed. This provides audible feedback to the operator, confirming switch actuation.

4.2.3.2 Indicator Lamps

POWER -

Indicates that AC power is applied to the machine.

PRINT CHK * -

In its steady ON state this light indicates that a print operation has been called for while the printer is in a "check" condition. A check condition occurs when a print wheel or carriage command received by the printer cannot be successfully completed, due to a malfunction (possibly caused by a paper jam or bent print wheel). A print wheel check condition disables the print wheel servo until a restore sequence clears the

check condition. A carriage check condition disables both the carriage and print wheel servos until a restore operation is performed.

When blinking, this light indicates that the printer is in the Pause mode.

PARITY -

Indicates detection of any of the following types of error:

- Incorrect parity sensed on a received character
- A framing error (no stop bit) detected on a received nonbreak character

A DEL (␣) character is substituted for the erroneous character. This light functions only if the PARITY ENABLE switch is ON.

OVFL * -

Indicates print buffer overflow.

RIBBON/PAPER * -

Indicates that the end of the ribbon has been reached, or that the printer is out of paper, and a print operation has been attempted.

COVER * -

With base program firmware at level -03 or later, the COVER light comes ON immediately when the sound panel is opened. With base firmware at levels prior to -03, the COVER light comes ON when an attempt to print is made with the sound panel open.

- * These errors cause a Break to be transmitted in Remote mode if DC1/DC3 protocol is not selected.

4.3 AC POWER ON-OFF SWITCH AND LINE FUSE

The AC power On-Off switch and line fuse are located at the right-hand rear of the machine as part of the internal power supply assembly, as shown in Figure 4-3.

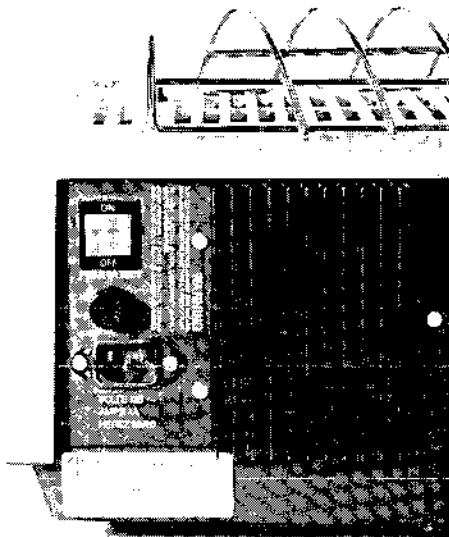

Figure 4-3. AC POWER ON-OFF SWITCH AND LINE FUSE

4.4 THE DIABLO MODEL 630 KEYBOARD

The Diablo Model 630 Keyboard supports both the standard and APL versions of the ASCII data interchange mode. The key arrangement comprises three sections, as shown in Figure 4-4: The left-hand "control" section, the center "alphameric" section, and the right-hand 10-key pad "numeric" section. The standard key assignments are shown in Figure 4-5. Special key assignments for the Control (CTRL) mode are shown in Figure 4-6, and those for the Escape (ESC) mode are shown in Figure 4-7.

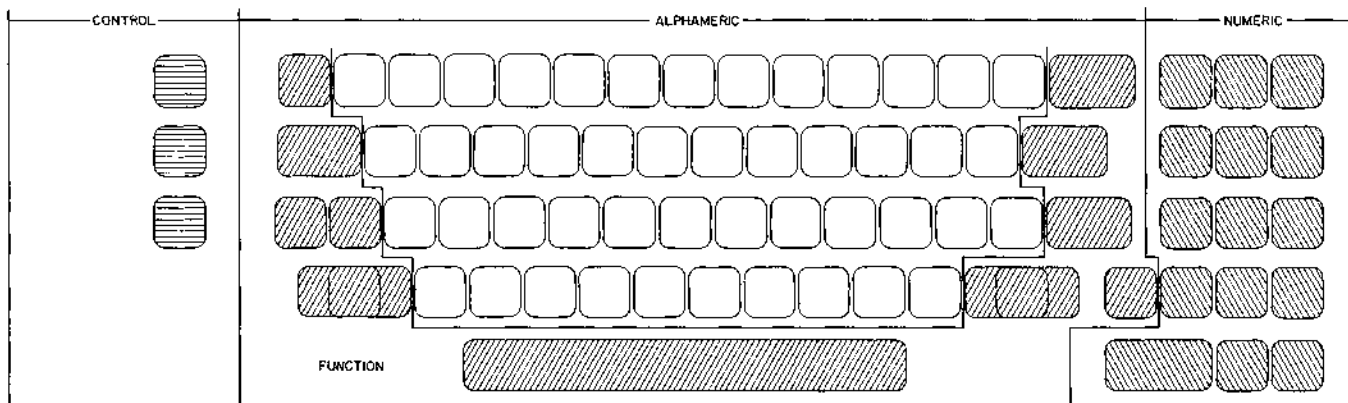

Figure 4-4. MODEL 630 KEYBOARD SECTIONS

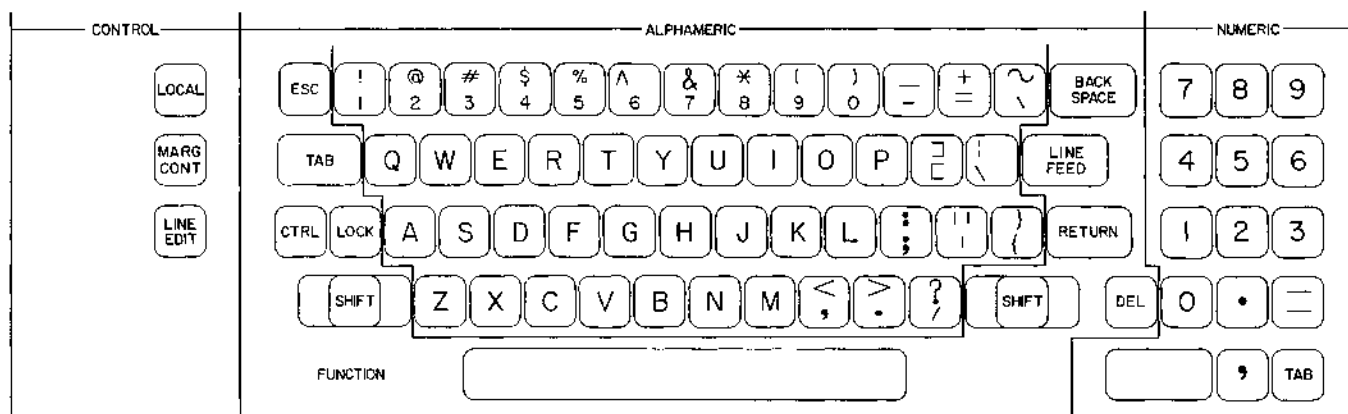

Figure 4-5. STANDARD KEYBOARD ASSIGNMENTS

The following paragraphs describe the function of the keys found in each section of the keyboard.

The Control Section - This section contains three alternate-action keys:

- LOCAL - Selects the LOCAL operating mode when DOWN, and the REMOTE operating mode when UP. In the Remote mode, the terminal transmits and receives data, via the communications link, with other terminals or with the host computer. In the Local mode the terminal is disconnected from the communications link, and functions as a typewriter.

- MARG CONT - When this key is DOWN (activated), it enables a local carriage return and line feed whenever a space or hyphen (-) character occurs within the 5-column "hot zone" immediately preceding the right margin. It also causes the alarm to sound when the print position crosses the hot zone boundary. See also subsection 4.23.1.13.
- LINE EDIT - When this key is DOWN (activated), it allows the current print line to be verified and corrected before it is transmitted (Remote mode) or printed (Local or Half-Duplex mode). See also subsection 4.23.1.12.

The Alphameric Section - This section contains 47 keys in typewriter-paired or logical bit-paired configuration, plus 11 function and control keys. All keys except the ESC key are repeating keys. The ESC key and the CTRL key serve to redefine the functions of several other keys, as outlined in subsection 4.5, CONTROL CODES; and subsection 4.6, ESCAPE CODE SEQUENCES.

The Numeric Section - This section contains a 10-key pad with period, hyphen, space bar, comma and tab keys. The key assignments in this section do not change with Shift key operation, and are therefore useful in place of their alphameric counterparts while the terminal is in the shifted or CTRL modes.

4.5 CONTROL CODES

The Model 630 responds to a standard set of ASCII Control Codes. Codes can be generated from the keyboard, and used internally (Local); and they can also be transmitted and received thru the communications interface (Remote) for use by the connected system or the Model 630.

Control characters are generated from the keyboard by holding down the CTRL key while depressing various other keys. The affected other keys are shown in Figure 4-6. As shown, the CTRL key does not alter the function of any of the keys in the Control or Numeric sections of the keyboard, nor of the function keys in the Alphameric section. The CTRL key overrides the SHIFT keys. If the CTRL key is depressed while the unit is in the "shifted" mode, the CTRL function will prevail. The standard Diablo Typewriter Paired keyboard deviates slightly from ASCII conventions in that the Diablo keyboard produces an RS control code from the "=" (equals) key, and a GS code from the "`" (accent) key. In standard ASCII, the RS and GS codes correspond to the ^ and] ASCII characters respectively.

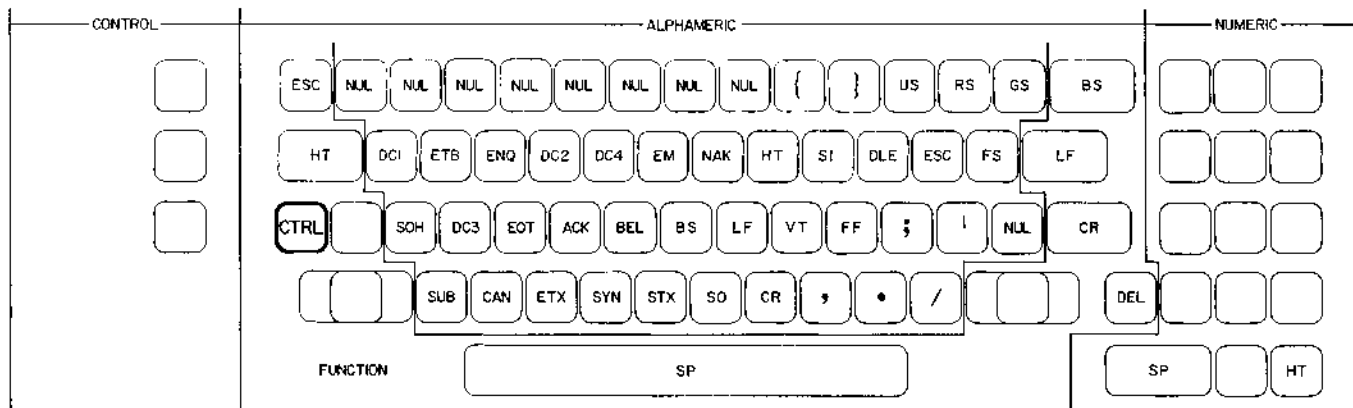

Figure 4-6. CTRL MODE KEY ASSIGNMENTS

The Control Characters recognized by the Model 630 HPRO5 are summarized below. The standard ASCII Code Chart shown in Figure 5-1 lists the Control Characters and their corresponding ASCII codes. The Operator, however, normally need not be concerned with the actual codes for the Control Characters.

- ACK - This code is used in conjunction with ETX for the ETX/ACK communications protocol. (See subsection 4.7.2.)
- BEL - Sounds the audible alarm (buzzer) for 1/2 second. Updates all summarized motion and suspends processing of further characters until all printer activity is complete.
- BS - Backspaces the carriage one print position (HMI) in Normal mode, or 1/60 inch in Graphics mode. Direction of movement reverses in the Backward Print mode.
- CR - Causes a carriage return. If the AUTO LF switch is ON, the CR code also causes a line feed operation.
- DC1 - This code is used in conjunction with DC3 for communications protocol. (See subsection 4.7.1.)
- DC3 - This code is used in conjunction with DC1 for communications protocol. (See subsection 4.7.1.)
- DEL - This signal is ignored by the Model 630 in all Remote modes. It can be used as a buffer or "sluff" code the same as NUL. In the Local mode, this signal will cause printing of the Logical NOT symbol (~).
- ENQ - Receipt of this signal initiates the automatic answer-back sequence "Here Is . . ." if that option is installed.
- ETX - This code is used in conjunction with ACK for the ETX/ACK communications protocol. (See subsection 4.7.2.)
- ESC - This code is always received as the first character of a 2- or 3-character command sequence. (See subsection 4.6.)
- FF - Initiates form feed to the top of the next form (page), or to the top margin on the next form or page if one has been set.
- HT - Initiates movement of the carriage to the next previously-set Horizontal Tab Stop.
- LF - Initiates movement of the paper up one line (one VMI). Movement changes to 1/48" per command in the Graphics mode, or two line feed operations if Double Line Feed is selected.
- NAK - Transmitted by Model 630 when certain error conditions occur. (See subsection 4.7.1.)
- NUL - This code is ignored by the Model 630 in all modes. It can be used as a buffer or "sluff" code.
- SI - Causes exit from Program Mode.

- SP - Initiates movement of the carriage one print position (HMI) in Normal mode.
- VT - Initiates movement of the paper up to the next previously-set Vertical Tab Stop.

4.6 ESCAPE CODE SEQUENCES

The Escape mode is entered by momentarily depressing the ESC key, or by receiving the ESC control code over the communications interface. This code is always received as the first character of a 2- or 3-character "Escape Code Sequence". The ESC code conditions the Model 630 to receive the next one or two characters, uninterrupted by a CR, as commands and not print data. Upon receiving the last character in the ESC code sequence, the Model 630 executes the command, and then terminates the Escape mode.

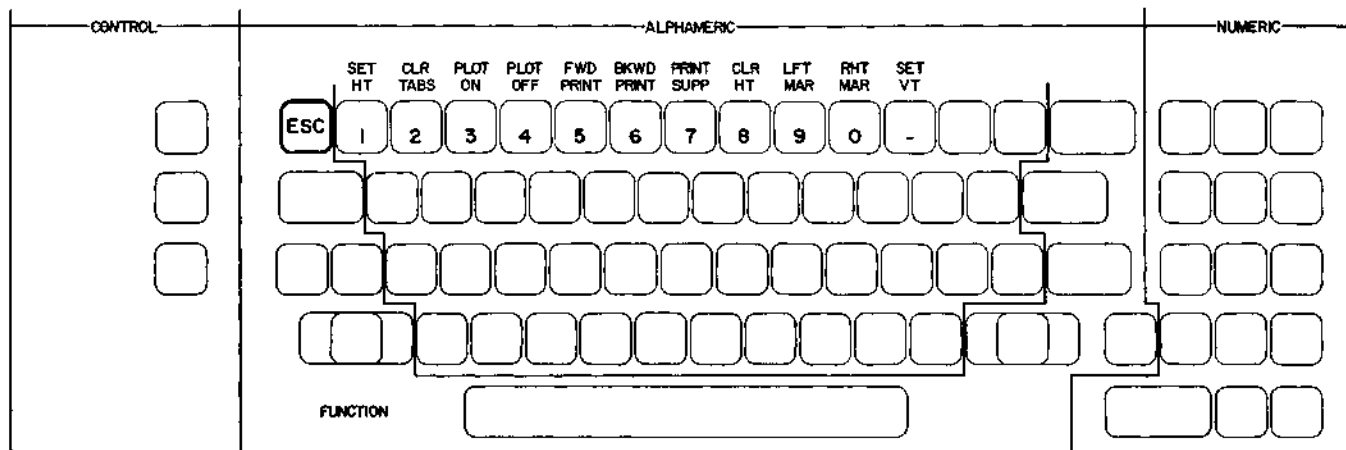

Figure 4-7. ESC MODE KEY ASSIGNMENTS

Figure 4-7 shows the ESC Mode Key Assignment, and the following list summarizes the ESC code command sequences.

Characters			<u>Description of Command</u>
(1)	(2)	(3)	
ESC	1		Set Horizontal Tab Stop at current Carriage (print) position
ESC	2		Clear all Horizontal and Vertical Tabs
ESC	3		Graphics mode ON (clear with CR)
ESC	4		Graphics mode OFF
ESC	5		Forward Print mode ON
ESC	6		Backward Print mode ON (clear with CR)
ESC	7		Print Suppression ON (clear with CR)
ESC	8		Clear Individual Horizontal Tab Stop at Current Carriage (print) Position
ESC	9		Set Left Margin at current Carriage (print) position
ESC	0		Set Right Margin at current Carriage (print) position
ESC	HT	(n)	Initiate Absolute Horizontal Tab to print position (n)*
ESC	LF		Perform Negative Line Feed
ESC	VT	(n)	Initiate Absolute Vertical Tab to line (n)
ESC	FF	(n)	Set lines per page to (n)*
ESC	-		Set Vertical Tab Stop at current paper position

ESC	CR	P	Initiate Remote RESET (Allow 1 second for completion before next command.)
ESC	RS	(n)	Set Vertical Motion Index (VMI) to (n-1)**
ESC	US	(n)	Set Horizontal Motion Index (HMI) to (n-1)**
ESC	A		Print in Secondary Color (red - ribbon down)
ESC	B		Print in Primary Color (black - ribbon up)
ESC	C		Clear Top and Bottom Margins
ESC	D		Perform Negative Half-Line Feed
ESC	U		Perform Half-Line Feed
ESC	L		Set Lower Page Margin at current paper position
ESC	T		Set Top Page Margin at current paper position
ESC	Y		Print the Print Wheel Character under ASCII Code 20 ₁₆
ESC	Z		Print the Print Wheel Character under ASCII Code 7F ₁₆
ESC	?		Enable Auto Carriage Return mode
ESC	!		Disable Auto Carriage Return mode
ESC	/		Enable Auto Backward Printing mode
ESC	\		Disable Auto Backward Printing mode
ESC	S		Set HMI to value defined by setting of SPACING switch
ESC	SYN	(n)	Select Foreign Language and/or Print Wheel Size (See Table 4-1 for selection of n)
ESC	>		Normal Printing Mode
ESC	<		Reverse Printing Mode
ESC	(Enter program "Here Is . . ." mode (with jumper A60-3/4 installed on HPRO5 circuit board)
ESC)		Exit program "Here Is . . ." mode
ESC	"		Enable Auto Line Feed (in units without control panel)
ESC	#		Disable Auto Line Feed (in units without control panel)

* = See subsection 5.4, Table 5-4, ESC Sequences for Absolute Horizontal Tab, Absolute Vertical Tab, and Lines/Page values.

** = See subsection 5.4, Table 5-3, ESC Sequences for HMI and VMI values.

NOTE: The following Options are present only in the Expanded and Word Processor versions of the Model 630.

HyPlot Option

ESC	G		HyPlot ON - Absolute Move (cleared by CR)
ESC	G	BEL	HyPlot ON - Absolute Plot (cleared by CR)
ESC	V		HyPlot ON - Relative Move (cleared by CR)
ESC	V	BEL	HyPlot ON - Relative Plot (cleared by CR)
ESC	.	(character)	Change Plot Character to (character)
ESC	,	hv	Set Plot Precision (See subsection 4.23.5)
ESC	4		Exit HyPlot Mode

Word Processing Option

ESC	P		Proportional Space ON (cleared by ESC S)
ESC	Q		Proportional Space OFF
ESC	DC1	(n)	Offset Selection (cleared by CR) See subsection 4.23.1.2.
ESC	E		Auto Underscore ON
ESC	R		Auto Underscore OFF
ESC	O		Bold Print ON (cleared by CR)
ESC	W		Shadow Print ON (cleared by CR)
ESC	&		Bold/Shadow Print OFF
ESC	%		Increase Carriage Settling Time to 20ms (cleared by ESC N)

ESC	BS		Backspace 1/120"
ESC	SO	M	Program Mode ON
ESC	X		Cancel all WP modes except Proportional Space
ESC	=		Auto Center ON (cleared by CR)
ESC	M		Auto Justify ON
ESC	\$		Margin Control ON (regardless of MARG CONT key setting)
ESC	*		Margin Control Mode determined by MARG CONT key setting

Remote Diagnostics Option
See also subsection 4.23.3.

(Note: The last three commands in this set are not Escape Code sequences.)

ESC	SUB	I	Initialize the Printer (standard in base firmware)
ESC	SUB	R	Remote Error Reset (standard in base firmware)
ESC	SUB	1	Request Status Byte 1
ESC	SUB	2	Request Status Byte 2
ESC	SUB	U	Enter User (programmable) Test Mode
ESC	SUB	W (n)	Enter Wrap-Around (Echo) Test Mode (Model 630 echoes each byte (n) received from the host computer.)
ESC	SUB	X	Exit Test Mode
DEL			Error Correct Backspace (user test mode only)
STX			Print contents of Print Buffer once (user test mode only)
SOH			Print contents of Print Buffer repeatedly (user test mode only)

4.7 HPRO5 COMMUNICATIONS PROTOCOLS

The communications protocols prevent print buffer overflow when print data is being received faster than the print buffer is being emptied. The print buffer in the Model 630 HPRO5 has a capacity of 768 bytes in the basic version and 2688 bytes in the expanded version. A communications protocol is required by the Model 630 at all baud rates above 300, and in some applications may also be required at and below 300 baud.

Two switches on the HPRO5 circuit board control selection of DC1/DC3 and/or ETX/ACK communications protocols. Either, neither or both of these protocols can be enabled at the same time. Printer Ready protocol is always active, regardless of the selection of DC1/DC3 (XON/XOFF) or ETX/ACK. In addition to print buffer control, the DC1/DC3 and Printer Ready protocols also respond to error conditions within the Model 630.

4.7.1 DC1/DC3 (XON/XOFF) Protocol

In DC1/DC3 protocol, a DC3 control code character is transmitted by the Model 630 under any of the following conditions:

1. Print buffer nearly full (within 64 bytes)
2. Cover Open
3. Paper Out *
4. End of Ribbon *
5. Printer in Check condition
6. Pause switch depressed

* With paper out or end of ribbon, a DC3 is sent only when printing is attempted.

A NAK character will be transmitted (in addition to DC3) for conditions 2 - 5 above if the unit is equipped with HPRO5 base program firmware at design level -03 or later, and if both DC1/DC3 and ETX/ACK are enabled. The NAK character thus distinguishes the "error" conditions from the two conditions Print Buffer Full and Pause. NAK is also sent when a parity error is detected if parity checking is enabled.

Once a DC3 has been transmitted, the Model 630 will transmit a DC1 character when the print buffer is nearly empty (within 64 bytes) and conditions 2 thru 6 do not exist. Conditions 2 thru 6 can be cleared by pressing the RESET switch on the control panel.

4.7.2 ETX/ACK Protocol

Using this protocol, when the host computer sends a string of print data to the terminal, it includes an ETX control code character at the end of the string. When the ETX character eventually is retrieved from the print buffer, the Model 630 transmits an ACK character back to the host to indicate that it is ready to accept more data. With this protocol, the host has the responsibility of ensuring that any data string transmitted does not exceed the capacity of the print buffer, since the terminal does not send a response to indicate when the print buffer is nearly full.

4.7.3 Printer Ready Protocol

The Printer Ready protocol uses a dedicated interface line (pin 11) instead of special control characters as used with DC1/DC3 (XON/XOFF) and ETX/ACK. The Data Terminal Ready interface line (pin 20) also will respond the same as the Printer Ready line, if the jumper is installed at position A60 pins 5 and 6 on the HPRO5 circuit board.

The +PRINTER READY signal goes LO under any of the following conditions:

1. Print buffer becomes nearly full (within 64 bytes)
2. Cover open
3. Paper out *
4. End of ribbon *
5. Printer in Check condition
6. Pause switch depressed

* With paper out or end of ribbon, +PRINTER READY goes LO only when printing is attempted.

The +PRINTER READY signal returns HI when the print buffer becomes nearly empty (within 64 bytes) and all the other conditions are corrected.

4.8 PRINT WHEEL AND LANGUAGE SELECTION

4.8.1 Print Wheel Selection

On units equipped with an operator control panel, print wheel selection is accomplished with the PRINT WHEEL SELECT rotary switch on the control panel. The operator must ensure that the switch setting matches the type of print wheel installed.

On units without a control panel, a jumper plug on the HPRO5 circuit board at location A60, pins 1 and 2, determines print wheel selection. This jumper plug is not accessible to the operator. With the jumper plug installed, print wheel selection defaults to 96-character Diablo metal wheels at power-on or Remote Reset (ESC CR P). With the jumper plug out, print wheel selection defaults to 96-character plastic wheels. Installation of a control panel overrides the jumper plug.

On units without a control panel, print wheel selection can also be done remotely by executing the sequence ESC SYN (n). Byte (n) is defined in Table 4-1 below.

4.8.2 Language Selection

On units without a control panel, the language selection defaults to standard ASCII at power-up. On units with a control panel but without a keyboard, language font selection is made by switches 6, 7 and 8 on the HPRO5 circuit board, as described in subsection 3.1.2. On the Expanded HPRO5, the language select parameter stored in the nonvolatile RAM overrides these switches.

On units equipped with a keyboard, language selection is determined by the configuration of the keyboard being used. Subsection 5.2 describes the various keyboard configurations available for the Model 630.

Language font selection can also be done remotely, regardless of whether a keyboard is present, by executing the sequence ESC SYN (n). Byte (n) is defined in Table 4-1. The print wheel type (88, 92, 96) must be correctly selected on the control panel rotary switch. In all cases, ESC SYN (n) overrides all other means of language selection. Also, in the Expanded HPRO5, the ESC SYN (n) language selection is stored in the nonvolatile RAM and can be changed only by a subsequent ESC SYN (n). (See 4.23.4.2 and Appendix A.)

Table 4-1
PRINT WHEEL AND LANGUAGE SELECTION
(Byte n)

<u>7</u>	<u>6</u>	<u>5</u>	<u>4</u>	<u>3</u>	<u>2</u>	<u>1</u>	<u>Print Wheel Selection</u>	
X	0	0	0	X	X	X	96-Character Metal - Diablo	} Without control panel only
X	0	0	1	X	X	X	96-Character Plastic - Diablo	
X	0	1	0	X	X	X	96-Character Metal - Rank Xerox	
X	0	1	1	X	X	X	Plastic - APL	
X	1	0	0	X	X	X	92-Character Metal - Rank Xerox	
X	1	0	1	X	X	X	Metal - APL	
X	1	1	0	X	X	X	88-Character Metal - Xerox	
X	1	1	1	X	X	X	Optional Wheel	
							<u>Language Selection</u>	
X	X	X	X	0	0	0	Default (Typewriter Paired)	
X	X	X	X	0	0	1	Typewriter Paired	
X	X	X	X	0	1	0	Logical Bit Paired	
X	X	X	X	0	1	1	APL	
X	X	X	X	1	0	0	French Azerty	
X	X	X	X	1	0	1	German	
X	X	X	X	1	1	0	Scandinavian	
X	X	X	X	1	1	1	Norsk	

Notes: Bits 1 - 3 of Byte (n) perform Language Selection.
 Bits 4 - 6 of Byte (n) perform Print Wheel Selection.
 Bit 7 must be set to 1 if bits 6 thru 1 are 0.
 X = Don't Care
 0 = OFF
 1 = ON

4.9 PRINTING FORMAT

Printing format is dependent on three primary factors; horizontal character spacing, vertical line spacing, and number of lines per page. Each of these factors can be independently controlled. An "index" is used to define the specific motion desired for both horizontal character spacing and vertical line spacing. Any point on a page can be defined in terms of a "horizontal position" and a "vertical position". The number of lines per page can easily be changed when necessary.

4.9.1 Definition of Terms

Figure 4-8 and the text below describe some of the points associated with a simple page layout.

ORIGIN: The position of the print head after a form feed (with no top margin set) and an absolute horizontal tab to print position 1 (horizontal position 0). The first print position on the first line of a page.

HORIZONTAL MOTION INDEX (HMI): Determines the distance, in multiples of 1/120", that the carriage moves after printing a character (or when spacing). Minimum HMI is 0, maximum is 125; thus, minimum distance is 0 x 1/120" and maximum is 125 x 1/120" (1.04" nominal).

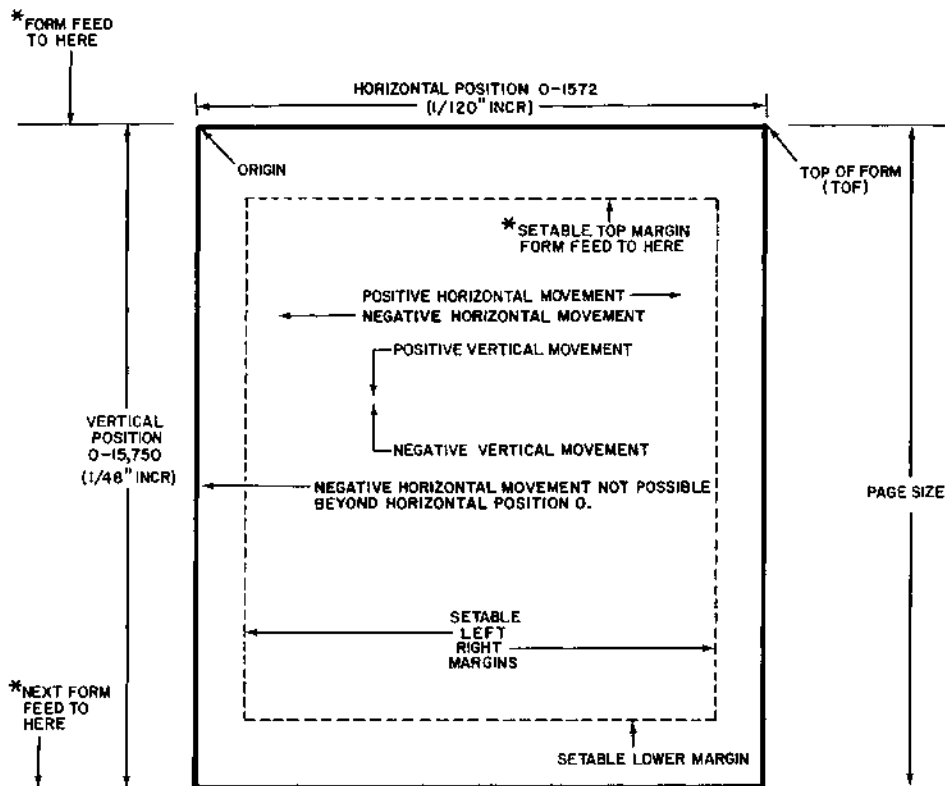

- Width of Print Position = Horizontal Motion Index (HMI) and is variable from 0 to 125 (1/120") increments.
 Print Position Number = $\frac{\text{Horizontal Position}}{\text{HMI}} + 1$ = Horizontal Tab Position. Tab Positions limited to first 160 Print Positions.
 Height of Line = Vertical Motion Index (VMI) and is variable from 0 to 125 (1/48") increments.
 Line Number = $\frac{\text{Vertical Position}}{\text{VMI}} + 1$ = Vertical Tab Position. Total number of lines can be specified from 1 to 126.
 Page Size = Number of lines x VMI.

* If a top margin is set, the Form Feed will advance beyond the Top of Form to the top margin.

Note: Movement arrows depict carriage movement relative to paper and not actual paper movement direction.

Figure 4-8. PAGE LAYOUT AND PRINTING FORMAT

VERTICAL MOTION INDEX (VMI): Determines the distance, in multiples of 1/48", that the paper (platen) moves for each line feed, negative line feed, etc. Minimum VMI is 0, maximum is 125; thus, minimum distance is 0 x 1/48" and maximum is 125 x 1/48" (2.6" nominal). When VMI = 0, no paper movement occurs.

ABSOLUTE HORIZONTAL POSITION: The horizontal distance, in 1/120 inch increments, between the print head position and the origin. Minimum absolute horizontal position is 0, maximum is 1572 (13.1" x 120).

ABSOLUTE VERTICAL POSITION: The vertical distance, in 1/48 inch increments, between the current print line and the first line on the page (the origin). Minimum absolute vertical position is 0, maximum is 15,750 (125 x 126 lines per page).

PRINT POSITION: The horizontal area capable of being occupied by a single printed character. This is similar to a print "column" on a line printer, except that it is variable. That is, the number of print positions per line is dependent on the HMI. The minimum number of print positions per line is 13 when HMI = 125, the maximum is 1573 when HMI = 1. The leftmost print position is position 1. Print position may be calculated as follows:

$$\text{Print Position} = \frac{\text{Horizontal Position}}{\text{HMI}} + 1$$

LINE: The vertical distance capable of being occupied by a row of printed characters. The height of the line is equal to VML. Line number may be calculated as follows:

$$\text{Line Number} = \frac{\text{Vertical Position}}{\text{VMI}} + 1$$

LINES PER PAGE: The actual number of print lines per page of paper. Lines per page can be set to any number from 1 thru 126.

4.9.2 Standard Formats

Any one of three standard formats can be selected via the SPACING (Pitch) switch on the Operator Control Panel. These formats are summarized in Table 4-2.

Table 4-2
STANDARD PRINTING FORMATS

SPACING Switch	Horizontal Spacing			Vertical Spacing		
	Char/in.	Char/line	HMI	Lines/in.	Lines/page	VMI
10	10	132	12	6	66	8
12	12	158	10			
15	15	197	8			

Whenever the SPACING switch is repositioned and an optional format has not been selected, the values listed in the table for the new position are used for horizontal and vertical spacing, and for lines per page.

Additional formats can be obtained by changing the HMI, VMI, or Lines Per Page. Such variable indexing overrides the SPACING switch function. Control can be restored to the SPACING switch by issuing the ESC S sequence.

4.9.3 Optional Formats (Variable Indexing)

Any of the three format factors can be altered by utilizing special escape (ESC) sequences. The ESC CR P (remote RESET) sequence may also be used here to cancel all optional format factors and return to the format selected by the SPACING switch. Refer to subsection 4.6 for a detailed listing of all ESC sequences.

Execution of any of these sequences does not cause the current horizontal or vertical position to immediately change. It does, however, change subsequent operations by redefining the variable format factors. It is recommended that a Form Feed (FF) and an Absolute Tab (see subsection 4.13) to location 0 be performed prior to changing any format factors.

4.9.4 Variable HMI

The standard HMI can be altered by executing the 3-character sequence ESC US (ASCII character), where the binary value of the selected ASCII character is one (1) greater than the number of 1/120 inch increments the carriage will move after printing a character or when spacing.

$$\text{HMI} = (\text{ASCII character} - 1) \times 1/120 \text{ inch}$$

NUL and DEL characters cannot be used, therefore the minimum HMI is 0 increments, and the maximum is 125 increments. See subsection 5.4, Table 5-3, to determine the appropriate ASCII character for the ESC sequence. An ESC S sequence will return control of HMI to the SPACING switch.

4.9.5 Variable VMI

The standard VMI can be altered by executing the 3-character sequence ESC RS (ASCII character), where the binary value of the ASCII character is one (1) greater than the number of 1/48 inch increments the paper is to move for each line feed, negative line feed, etc.

$$\text{VMI} = (\text{ASCII character} - 1) \times 1/48 \text{ inch}$$

Minimum VMI is 0, maximum is 125. See subsection 5.4, Table 5-3, to determine the appropriate ASCII character for the ESC sequence.

4.9.6 Lines Per Page

Lines per page is automatically set at 66 (or 72 if so jumpered) when the unit is initialized (restored at power up). The number of lines per page can be altered in ASCII mode by executing a 3-character sequence ESC FF (ASCII character) where the binary value of the ASCII character is equal to the number of lines per page desired. The minimum number of lines per page is 1, the maximum number is 126.

The following two formulas can be used to compute the desired number of lines per page:

$$\text{Lines Per Page} = \text{Number of Lines Per Inch} \times \text{Page Size in Inches}$$

$$\text{Number of Lines Per Inch} = \frac{48}{\text{VMI}}$$

Once the desired number of lines per page is known, use the information in subsection 5.4, Table 5-4, to determine the appropriate character for the ESC sequence.

4.10 FORWARD/BACKWARD PRINTING

The Model 630 is capable of printing forward (left to right) or backward (right to left) with equal ease. It is capable of both Automatic and Programmed backward printing. It can also operate in an Inverted Horizontal Motion mode.

4.10.1 Auto Backward Printing

Auto backward printing is enabled by the sequence ESC /. It is disabled by the sequence ESC \ . When the Model 630 is operating in the Auto Backward Printing mode, a line of text will be printed in the reverse direction only if all of the following conditions exist:

1. Auto backward printing is enabled.
2. Printing is at least one line behind print-queued data.
3. The line in question contains less than 256 characters following the first printable character. NOTE: In Auto Backward Printing, the horizontal tab (ASCII HT) occupies three character positions in the backward print buffer.
4. If it is a shorter distance for the carriage to move to the right-hand end of the next line than to move to the left-hand end.
5. No ESC sequences in effect except the following. Any other ESC sequence will force forward print for that line.

ESC Y or ESC Z	(Addresses print wheel character under 20 ₁₆ or 7F ₁₆)
ESC A or B	(Red or Black ribbon)
ESC E* or R*	(Auto Underscore ON or OFF)
ESC O*, W* or &*	(Bold or Shadow ON or OFF)
ESC BS*	(1/120" Backspace)
ESC X*	(WP options OFF)

* - Only if the unit is equipped with Word Processing enhancements.

Programmed Backward Printing can override Auto Backward Printing for a single line.

4.10.2 Programmed Backward Printing

This mode is entered by receiving the sequence ESC 6 from the communications link or from the keyboard. An ESC 5 sequence or a Carriage Return from either source will reestablish the forward printing mode.

During Backward Printing, each character printed causes incremental carriage movement to the left, just opposite of carriage motion during forward printing. The action of the Space and Backspace keys and codes are also reversed in Backward Printing. Note, however, that tabbing operations, carriage return, and all paper movement functions are unaffected by being in the Backward Print mode.

4.10.3 Inverted Horizontal Motion

For foreign languages and any other application requiring reversal of the entire page format, the sequence ESC < will establish the Inverted Horizontal Motion mode. In this mode, all horizontal motion is inverted, including tabbing. The carriage home position is redefined as the rightmost carriage position. The starting point for each line is considered to be at the right margin instead of at the left margin. If the Model 630 is equipped with the Nonvolatile RAM option, the Inverted Horizontal Motion mode is preserved at power-down, and restored at power-up.

Backward printing can also be performed when operating in the Inverted Horizontal Motion mode. In this case, backward printing is defined as printing from left to right. Normal left to right printing (Forward Printing) can be reestablished by the sequence ESC > .

4.11 PRINT SUPPRESSION

Print suppression is initiated by the sequence ESC 7, and cancelled by a carriage return (CR) command. While this feature is enabled, all printable characters are replaced by spaces. Escape sequences and control characters are not affected.

4.12 CONTROL OF MARGINS

Horizontal Margins: Both left and right margins can be adjusted by positioning the carriage to the desired print position, and then entering an ESC 9 or ESC 0 (LEFT MAR or RIGHT MAR) sequence. This may be done either remotely or thru the keyboard. Altering the left margin causes the carriage to return to the new print position setting following a carriage return (CR) command. Altering the right margin causes the audible alarm to sound for 1/2 second when typing continues beyond the new margin setting in the local mode.

The carriage can be moved to the left beyond the left margin only by using either Absolute Horizontal Tab or Backspacing, when the margin is set at some print position other than 1.

A power-on or a remote RESET operation will clear adjusted margins to print position 0 and 1572.

Vertical Margins: Both top and bottom vertical margins can be adjusted by first placing the paper in the top-of-form position, then moving the paper up with a series of LINE FEED operations to reach the desired top margin position. This "Top Margin" is then set by executing an ESC T sequence. Advancing the paper with LINE FEED operations to the desired "Bottom Margin" position, and then executing an ESC L sequence sets the bottom margin. The bottom margin must always be set below the upper margin, and both must be within the page size boundaries.

Whenever a lower page margin is crossed with a line feed, auto line feed or half line feed, paper movement automatically positions the print head at the top margin on the next page, eliminating the need for a form feed character. The area between the lower margin of one page and the top margin of the next page can be accessed through vertical tabs (absolute and normal), and through negative line feeds.

Top and bottom margins are reset to the top-of-form and bottom-of-page locations whenever page size is altered, or a remote RESET is received. They are also reset (or initialized) on power-up, or upon receipt of a remote ESC C command.

4.13 TABBING

Two methods of tabbing are available for both horizontal and vertical motion. One method, called "Normal Tab", is similar to the traditional system used on typewriters in that tab stops are set at predetermined positions. The carriage or paper then moves to these positions sequentially on command. The second method is termed "Absolute Tab". This method is unique in that it does not require prior setting of tab stops. The carriage or paper is positioned directly to any one of 126 possible positions either horizontally or vertically from any other position. In the case of vertical tabbing, the paper should be moved "forward only", unless the unit is equipped with optional bidirectional paper handling accessories. Tab stops can be set or cleared, and tab commands executed, either locally or remotely.

Both methods of tabbing provide horizontal and vertical positioning to standard print positions or lines. This makes it possible, by using variable indexing, to print data out in any format desired without prior editing. For example, data that was originally formatted for 10 characters per inch, 6 lines per inch, can be printed out at 12 characters per inch, 4 lines per inch (or any other format), and all tabular material will remain in the same relative position.

The method of tabbing to be used is specified by the character sequence used. The Horizontal Tab (HT) character or Vertical Tab (VT) character alone executes a Normal Tab operation. An ESC HT or ESC VT sequence, plus an ASCII character executes an Absolute Tab.

Since tabbing provides positioning only to normal print positions and lines, finer positioning requires use of the Graphics mode. All tabbing functions are unchanged in Graphics mode.

4.13.1 Normal Horizontal Tab

Horizontal tab stops can be set at any print position up to position 160 by positioning the carriage to the desired print position and executing an ESC 1 sequence. Keeping in mind that tab stops can only be set at the first 160 print positions, the formula for determining a tab position is:

$$\text{Horizontal Tab Position (1 thru 160)} = \frac{\text{Horizontal Position}}{\text{HMI}} + 1$$

A keyboard TAB command automatically causes the carriage to move to the next sequential tab stop. Should a TAB move be commanded with no tab stop having been set to the right of the present carriage position, the carriage will not move and the alarm will sound. Individual horizontal tab stops can be cleared by first positioning the carriage to that print position and then executing an ESC 8 sequence. All tab stops, both horizontal and vertical, can be cleared simultaneously by executing an ESC 2 sequence.

4.13.2 Absolute Horizontal Tab

In this mode, the carriage can be positioned directly to any of the first 126 print positions without the need for prior setting of tab stops. Also, Absolute Tab Stops are not retained in memory, so each stop must be commanded anew each time it is to be used. The command sequence for this is ESC HT (ASCII character), where the value of the ASCII character indicates the print position desired. See subsection 5.4, Table 5-4, to determine the appropriate ASCII character for the ESC sequence.

The leftmost print position is considered to be binary location 1. Any ASCII character other than NUL and DEL can be used, enabling direct tabbing to any of the first 126 print positions. Note that this method of tabbing also permits tabbing leftward. The horizontal position at the completion of an Absolute Tab operation is computed as follows:

$$\text{Horizontal Position} = (\text{ASCII character} - 1) \times \text{HMI}$$

4.13.3 Normal Vertical Tab

Vertical tabs are set with reference to the top-of-form position. This position, the first print line on the page, is reached by a keyboard FORM FEED command, followed by a manual adjustment of the paper location vertically to locate the paper in proper position. Vertical tab stops may then be set at any other line on the page by first moving the paper to the desired line by means of a series of LINE FEED commands, and then execut-

ing an ESC - sequence. This is repeated for each desired tab stop. The location of the vertical tab stop is defined as follows:

$$\text{Vertical Tab Position} = \frac{\text{Vertical Position}}{\text{VMI}} + 1$$

Once vertical tab stops are set, subsequent VT commands will cause the paper to be indexed upward to the next sequential vertical tab stop. If there are no more stops set between the present print line and the end of the form, the paper will not move and the audible alarm will sound. Individual vertical tab stops cannot be cleared as can the horizontal tab stops. All tab stops, horizontal AND vertical, are cleared simultaneously by executing the ESC 2 sequence.

4.13.4 Absolute Vertical Tab

In this mode, the paper can be moved to any of the 126 possible lines on the page. Absolute Vertical Tab is initiated by executing the sequence ESC VT (ASCII character), where the value of the ASCII character chosen determines the number of the line to be reached. See subsection 5.4, Table 5-4, to determine the appropriate ASCII character for the ESC sequence. NUL and DEL are not used. The top print line on the page is assigned the binary value of 1, with each succeeding line down the page assigned the next higher number. It is impossible to tab beyond the end of the page even if the number of lines per page is less than the maximum 126. The actual amount of paper movement is determined by; (a) the paper position before VT execution, (b) the ASCII character used, and (c) the Vertical Motion Index (VMI). The ultimate position reached is determined as follows:

$$\text{Vertical Position} = (\text{ASCII character} - 1) \times \text{VMI}$$

4.14 LINE FEED

A LINE FEED (LF) command from either the keyboard or the communications link will cause the form to be moved up one line (one VMI). An ESC LF sequence acts as a negative line feed, causing the paper to be moved down one line. A line feed is also performed automatically as a result of a carriage return operation when AUTO LF is ON. In units without a control panel, automatic line feed is enabled by the Escape sequence ESC ", and disabled by ESC #.

4.15 HALF LINE FEED

A Half Line Feed (ESC U) causes the paper to move up 1/2 line (1/2 of the VMI). A Negative Half Line Feed (ESC D) moves the paper down 1/2 line. These two commands are unchanged in Graphics mode. If the VMI is set to some odd number, the total paper movement will be one increment (1/48 inch) less than 1/2 line.

4.16 FORM FEED

A FORM FEED command, issued either remotely or thru the keyboard, will cause the paper to be moved up to the first line of the next page, or to the top margin line if one has been set.

4.17 CARRIAGE RETURN

A CARRIAGE RETURN (CR) command from the keyboard or the communication link will cause the carriage to return to the left margin (Normal Printing Mode) or right margin (Reverse Printing Mode).

4.18 AUTO CARRIAGE RETURN

The Auto Carriage Return mode is enabled by ESC ? from the keyboard or the communication link, and disabled by ESC ! . When this mode is enabled, a carriage return occurs automatically when the carriage reaches print column 132. An automatic carriage return also causes a line feed, regardless of the setting of the AUTO LF switch.

4.19 GRAPHICS

An ESC 3 sequence, issued either remotely or thru the keyboard, will put the Model 630 into the Graphics mode. A carriage return command or an ESC 4 sequence will return the unit to normal operation. While in the Graphics mode, carriage movement is completely divorced from printing; i.e., printing a character does not automatically move the carriage. Carriage movement occurs in 1/60 inch increments for space and backspace commands, and in response to tab commands. Also, in the graphics mode, paper feed movement in response to line feed commands is in 1/48 inch increments. Vertical tab, form feed, top of form and margin commands remain unchanged. Half-Line Feed (ESC U) and Negative Half-Line Feed (ESC D) act the same in Graphics mode as they do in Normal mode.

The Graphics mode provides a rudimentary means of charting, graphing and plotting with the Model 630 terminal. The Graphics mode relies entirely on the host system software for control; in contrast to the more sophisticated HyPlot Vector Plotting option of the Model 630, with which several of the plotting parameters are programmable at the terminal. The HyPlot option is described in subsection 4.23.5.

4.20 TWO-COLOR PRINTING (Optional Feature)

On units equipped with the two-color ribbon option, two-color printing can be achieved by installing a Diablo two-color ribbon cartridge. The mechanism initializes to print in the primary color (black). To print in the alternate color (red), execute an ESC A sequence. To return to the primary color, execute an ESC B sequence or an Initialize sequence. The ribbon position should not be changed at a rate exceeding 3 times per second.

Note: Factory adjustment optimizes performance using a 5/16" multi-strike ribbon. Subsequent adjustment may be necessary if 2-color ribbon is going to be used.

4.21 RESET/INITIALIZATION

4.21.1 Limited Reset

This operation is initiated by either:

- The RESET switch on the control panel.
- An ESC SUB R sequence through the interface, or from the keyboard.

The results of the Limited Reset operation are:

- Any existing error indications are reset.
- A Restore operation occurs if the printer is in a Check condition.

4.21.2 Initialize

An Initialize operation is initiated by any of the following actions:

- Application of power to the Model 630
- Execution of remote reset command (ESC CR P)
- Execution of command "Initialize Printer" (ESC SUB I)

(Subsection 4.23.3.3 points out the differences of execution between ESC CR P and ESC SUB I)

Initialization resets all the logic circuits, resets all program counters to zero, and sets the operating parameters of the unit as listed below. The unit will not respond to any remote or keyboard input until the restore cycle is completed.

NOTE: If the unit is equipped with the Nonvolatile RAM option, the initialized status of several of the parameters listed below is subject to variation as described in subsection 4.23.4.2 of this manual.

1) All Configurations of the Model 630

- Normal Print Mode
- Forward Print Mode
- Left-to-Right Forward Print Direction (Print Position 0 at leftmost carriage position)
- Carriage moved to Horizontal Position 0
- Vertical Position cleared to 0 (paper does not move)
- VMI Set to 8 (6 lines per inch)
- Lines per page set to 66 (page size of 528 corresponding to an 11-inch page)
- Print Suppression OFF
- Print in Black
- Auto Backward Printing enabled
- Left Margin set to position 0
- Right Margin set to position 1572
- Top Margin set to position 0 (line 1)
- Bottom Margin set to position 528 (line 66)
- All Horizontal and Vertical Tab Stops cleared
- Send and Print buffers cleared
- "HERE IS" programming enabled or disabled per jumper on the HPRO5 PCB (see Table 3-1 in subsection 3.1.1)

2) Model 630 Without Operator Control Panel - This configuration of the Model 630 restores to the conditions listed below, in addition to those in group (1) above.

- 96-Character Diablo plastic or metal print wheel per jumper on HPRO5 PCB
- 10 or 12 pitch per switch setting on HPRO5 PCB
- ASCII standard character sort
- Auto Line Feed OFF
- Auto Carriage Return OFF
- Baud Rate per switch settings on HPRO5 PCB
- Parity per switch setting on HPRO5 PCB
- Duplex per switch setting on HPRO5 PCB
- ETX/ACK ON
- DC1/DC3 ON or OFF per switch setting on HPRO5 PCB
- Self-Test ON or OFF per switch setting on HPRO5 PCB
- Automatic Error retries (8) enabled or disabled per jumper on HPRO5 PCB (for any Check condition). See Table 3-1 in subsection 3.1.1.

3) Model 630 With Control Panel and No Keyboard - This configuration of the Model 630 restores to the conditions listed below, in addition to those in group (1) above. Those parameters controlled by control panel switches default to the selections made by the switch settings (see subsection 4.2).

- Language Select via HPRO5 DIP switches
- Option Baud Rate per HPRO5 DIP switches
- ETX/ACK ON or OFF per HPRO5 DIP switch
- DC1/DC3 ON or OFF per HPRO5 DIP switch

4) Model 630 With Control Panel And Keyboard - This configuration of the Model 630 restores to the same status as without the keyboard, with the following single exception:

- Language Select determined by keyboard configuration

4.22 INTERNAL DIAGNOSTICS (SELF-TEST)

The features of the self-test mode vary according to whether the unit has a control panel, and whether the jumper plug is present at position A60-1/2 on the HPRO5 circuit board. In its most comprehensive form, the self-test mode allows the operator to initiate individual tests on specific elements of the Model 630, or to select a single "Confidence Test" that combines several of the individual tests.

The Confidence Test is simple to use by even a nontechnical operator on units equipped with a control panel. Its purpose is to quickly test several major elements of the Model 630 and give a printed report of the results. This enables the operator to verbally relay the test results to a trained service technician to determine if a malfunction is occurring in the Model 630; and if so, the nature of the malfunction. The Confidence Test can be executed by all Model 630 configurations that include the HPRO5 circuit board.

The individual tests permit more extensive testing, and the test results are reported in greater detail than those of the Confidence Test. To enable individual test selection, the unit must be equipped with a control panel, and the jumper must be installed at location A60-1/2 on the HPRO5 circuit board. A general description of the individual tests is given in this manual (subsection 4.22.2), and they are covered in detail in the Model 630 Maintenance Manual.

In all cases, the test printout character spacing is 10 pitch.

4.22.1 Confidence Test

This test is composed of several of the individual tests executed in sequence. The printed test results from a properly functioning unit are shown in Figure 4-9, followed by a brief definition of each line in the test printout. Note that the shaded lines of the printout are present only when the HPRO5 board is equipped with pre-03 base firmware.

- 2) Turn ON the AC power.

Test Activity:

At power-on, the Model 630 enters the Self-Test mode and immediately begins test execution. A properly functioning unit will print the test results as shown in Figure 4-9. In the Self-Test mode, the Break, Pause and Reset switches function as described below.

BREAK Switch - Serves as an alternate-action Stop/Start switch. Successive operations of the BREAK switch alternately stop and start the test. The test resumes each time from the point where it was stopped.

PAUSE Switch - After the test has been stopped by the BREAK switch, this switch can be used to single-step through the test. Each time the switch is pressed, the test advances one step.

RESET Switch - When this switch is pressed, the test is interrupted and immediately starts again from the beginning.

4.22.1.3 Confidence Test With Control Panel - With Jumper A60-1/2 on the HPRO5 Circuit Board

- 1) With the AC power switched OFF, set the SPACING switch on the control panel to position 7.
- 2) Turn ON the AC power. At power-up, the buzzer will sound briefly and the word "test" will be printed. The Model 630 is now in the Self-Test mode.
- 3) Press the RESET switch. This selects the Confidence Test.
- 4) Press the BREAK switch to start the test.

Test Activity:

A properly functioning unit will print the test results as shown in Figure 4-9. In the Self-Test mode, the BREAK, PAUSE and RESET switches function as described below.

BREAK Switch - Serves as an alternate-action Start/Stop switch. After the test is first selected, the BREAK switch must be pressed to start test execution. Thereafter, successive actuations of the BREAK switch alternately stop and start the test. The test resumes each time from the point where it was stopped.

PAUSE Switch - After the test has been stopped by the BREAK switch, this switch may be used to single-step through the test. Each time the switch is pressed, the test advances one step.

RESET Switch - When this switch is pressed, the test stops immediately. The test will then restart from the beginning when the BREAK switch is pressed.

4.22.2 Individual Tests

This is only a basic overview of the individual tests and their use. Complete instructions for using and interpreting these tests is contained in the Model 630 Maintenance Manual.

NOTE: The individual self-tests are accessible only in units equipped with a control panel and with jumper A60-1/2 installed on the HPRO5 circuit board.

The Self-Test mode for individual test selection is activated at power-up if the SPACING select switch on the control panel is set to the SELF TEST position. In this mode, the functions of all the control panel lights and switches are redefined. Individual diagnostic routines are selected by dialing in the proper test number on the two rotary switches (PRINT WHEEL SELECT and SPACING), and then pressing the RESET switch.

A list of the test numbers and corresponding titles is given below.

Tests of HPRO5 and Associated Components

This series of tests is designed to verify the basic operation of the HPRO5 board, the serial interface, the control panel and the keyboard.

Test 00 - ROM TEST
01 - RAM TEST
03 - SERIAL INTERFACE WRAPAROUND TEST

PCE and SCE Tests

Test 20 - 8041 ROM TEST
22 - PCE PRINTER STATUS TEST

30 - PRINT WHEEL RESTORE TEST
31 - PRINT WHEEL SERVO TEST

40 - CARRIAGE RESTORE TEST
41 - CARRIAGE SERVO TEST

50 - SERVO DISABLE and DISPLAY CHECK STATUS
51 - PAPER FEED TEST.

Overall Printer Verification

Note: "X" denotes an unspecified setting of the PRINTWHEEL SELECT switch on the control panel; the setting must match the print wheel being used.

Test X4 - Combined HORIZONTAL MOTION TEST, VERTICAL MOTION TEST and PRINT TEST
X5 - SWIRL TEXT PRINTOUT
X7 - OVERALL PRINTER CONFIDENCE TEST
This test combines all of the above listed tests, except Paper Feed, executed in the following sequence:

HPRO5 Tests - 8085 ROM TEST
8085 RAM TEST

(continued)

PCE-SCE Tests - 8041 ROM TEST
CARRIAGE SERVO TEST (132 character positions)
CARRIAGE RESTORE
PRINT WHEEL SERVO TEST (all spoke positions)
PRINT WHEEL RESTORE

SWIRL TEXT PRINTOUT (96 lines)

4.23 Expanded Communications Set

The features in the expanded communications set are provided by the optional firmware in the Expanded HPRO5 version of the Model 630. The Word Processor version of the Model 630 contains these additional features also, except for the Nonvolatile RAM and the "Here is . . ." message capability. The following subsections describe operating considerations associated with these additional features.

4.23.1 Word Processing Enhancements

The Word Processing (WP) Enhancements option consists of several features that facilitate word processing applications of the Model 630 communications terminal. Most of the WP enhancement features are performed on a character by character basis. Those which require memory storage while being performed are:

- Line Edit
- Auto Line Center
- Auto Justify

The WP enhancements are compatible with all normal terminal operations except Graphics mode (Plot). All WP features are disabled during Graphics mode.

4.23.1.1 Proportional Space Printing

The proportional space mode facilitates use of proportional space (PS) print wheels on the Model 630. The print wheel lookup tables stored in the memory of the Model 630 include PS unit values. These PS unit values represent one-half the width required by each proportionally spaced character. Carriage movement during proportional space printing is controlled by printing each character in the sequence: Move-Print-Move; where the amount of "Move" is specified by the PS unit value assigned to that character. The letter "V", for example, has a PS value of 6, which is one-half of the 12/120" spacing a "V" requires. The "V", therefore, would be printed in the sequence: Move 6/120" - Print - Move 6/120". The sequence for printing an "i" (PS value 3) following the "V" would be: Move 3/120" - Print - Move 3/120". The total distance between the centerline of the "V" and the centerline of the "i" would be $6/120" + 3/120" = 9/120"$.

In fixed pitch mode, the printing sequence is Print-before-Move. The size of the Move is determined by the current active HMI value, which is selected by the SPACING switch on the control panel, or by remote HMI mode (see subsection 4.9.4).

The proportional space mode is selected by the SPACING switch on the control panel, unless the terminal is in the Remote HMI mode (see 4.9.4), in which case the SPACING switch is ignored. When proportional spacing is selected by the SPACING switch, the HMI automatically goes to 12 pitch.

The proportional space mode may also be selected by the sequence ESC P, and turned off by the sequence ESC Q. Once the ESC P sequence has been received, the SPACING

switches will be ignored and proportional spacing is used. When the ESC Q sequence is received, the Model 630 exits the proportional space mode, and horizontal spacing is then determined by the current HMI value until an ESC S sequence is received. An ESC S sequence returns control to the SPACING switch.

Entering and exiting proportional space mode via the Escape sequences does not change the HMI to 12 pitch as happens when proportional space selection is made by means of the SPACING switch. During proportional space mode, the HMI affects only tabbing and word space size (space and backspace).

There are times when certain data needs to be printed nonproportionally spaced even though a PS print wheel is being used in the Model 630. For example, when the display from a video terminal is to be printed to illustrate a document; if it is printed proportionally spaced, the columnar alignment of the information is lost. To avoid this, issue the ESC Q sequence to exit the proportional space mode, then issue an ESC US DLE sequence to set the HMI to 15 which is adequate to print all characters on the PS print wheel without any characters touching. When the nonproportionally spaced printing has been completed, revert to normal HMI by executing the ESC S sequence, and return to proportional space mode by executing an ESC P sequence.

All numeric characters have the same PS unit value (5). This allows numeric data to be printed aligned in columnar form without having to turn off proportional space printing. The starting position of the columns can be established by setting a tab at that position, and tabbing to it, or by using the absolute horizontal tab to move to the starting position (see subsection 4.13.2). If you are altering the value of the HMI during the print of each line, be sure that the HMI has the same value prior to each movement to the beginning of the column, to ensure that the starting position does not change.

4.23.1.2 Offset Selection

The normal way to change character spacing is to adjust HMI. However, for proportional space printing, HMI is ignored and table values are used. Thus, to add or subtract a constant to each table size, the 3-character sequence ESC DC1 ("character") should be used. The binary value of the "character" is added to each table size value, or HMI if it is controlling size, as well as to the space character. This continues until another ESC DC1 (character) sequence is received, or until offset is cleared by a carriage return (CR) or the sequence ESC X.

The seven bits of the "character" are defined as follows:

Bits 1 - 6	=	Size of offset (63 units maximum - 1/120" per unit)
Bit 7	=	Sign of offset (1 = negative)

If a negative offset (smaller character size) is desired, bit 7 should be set. If the resulting character size is zero or less, no carriage movement will occur. Note that because NUL and DEL cannot pass thru the serial receiver, positive offset values range from 1 thru 63 (0 000001 thru 0 111111), and negative values range from 0 thru 62 (1 000000 thru 1 111110). Refer to Figure 5-1 in Section 5 of this manual for a Code Chart showing the ASCII characters corresponding to these values.

4.23.1.3 Auto Underscore

Automatic underscoring is initiated by the sequence ESC E. The present carriage position is stored in memory as the start location. When the end position is reached, the carriage will underscore the area between the start location and the end position. The printed underscore characters will overlap and the ribbon advance will increase to prevent fading.

The end position is defined as the carriage position when one of the following events occurs.

- ESC R - The underscoring occurs, the carriage stops at the first position after the underscore, and the Model 630 exits the Auto Underscore mode.
- CR - The underscoring occurs, and the carriage returns to the left margin.
- LF - The underscoring occurs, the carriage stops at the first position following the underscore, and a line feed occurs.

Auto Underscore is exited by either sequence ESC R or ESC X. In both cases, the underscoring does occur prior to exit from the Auto Underscore mode.

4.23.1.4 Bold Overprint

Bold overprint is initiated by the sequence ESC O. Subsequent printable characters are struck twice with no intervening carriage motion. The normal ribbon advance occurs between character strikes. A carriage return (CR) or either of the sequences ESC & or ESC X will cause the Model 630 to exit the bold overprint mode.

NOTE: Bold Overprint and Shadow Print are mutually exclusive modes.

4.23.1.5 Shadow Print

Shadow print is initiated by the sequence ESC W. Subsequent printable characters are struck twice with 1/120" of carriage movement and normal ribbon advance between character strikes. This does not change the HMI or table size value for that character. Increased carriage settling time is used to improve Shadow Print quality. A carriage return (CR) or either of the sequences ESC & or ESC X will cause the Model 630 to exit the shadow print mode.

4.23.1.6 Carriage Settling Time Control

The carriage settling time can be increased to 20 msec by issuing the sequence ESC %. This provides more time for mechanical vibrations to damp out before printing to improve print quality, at a small sacrifice in print speed. The sequence ESC N will restore the normal carriage settling time.

4.23.1.7 Half-Unit Backspace

The sequence ESC BS will produce a 1/120" backspace movement of the carriage.

4.23.1.8 Program Mode

Program mode enables user control of spoke position, hammer energy, and ribbon advance. This allows the use of special print wheels without modifications to the Model 630. In Program Mode, two characters are sent for each character to be printed. The first character selects the print wheel spoke; the second establishes the hammer energy and ribbon advance. See subsection 5.5, Table 5-7, for Hammer Energy and Ribbon Advance units. Also, the Diablo Print Wheel Data Book, Publication No. 90044-XX, will prove very useful for operating the Model 630 in Program Mode.

Fixed-pitch spacing is controlled by HMI plus offset. If the Model 630 is in proportional space mode, spacing is controlled by the ribbon advance units (move RA, print, move RA) for each character plus offset.

Program mode is initiated by the sequence ESC SO M. It is turned off by either the control character SI or the sequence ESC X.

NOTE: MARG CONT and LINE EDIT keys do not function in Program Mode.

- Spoke Position Data (first character) -

The first character received is tested to determine if it is a control character or a spoke position character. If it is a control character, the normal processing of control characters will occur. If it is not a control character, it is assumed to be a spoke position character. The next character then will not be tested for control character parameters. The proper value to be sent for the first character is selected by applying the following formula according to the example given below:

Formula:

First Character = Binary equivalent of the decimal sum of:
(Electrical Spoke Position Number + 32)

Example: Addressing character "A" on 96-Character Metalized print wheel

- 1) Refer to Figure 5-12 in this manual to determine the spoke position number of the desired character (A). In this case, the spoke position number is 18.
- 2) Apply formula given above: $18 + 32 = \underline{50}$
- 3) Refer to Table 5-2 in this manual to determine the ASCII character that has a binary equivalent of decimal 50. The table shows that character to be a "2". The ASCII "2" then is the proper first character to send for addressing an "A" when operating in Program Mode with a Diablo 96-character metalized print wheel.

Note that only spokes 1 thru 94 can be distinguished from control characters. However, spokes 0 and 95 can be accessed by ESC Y and ESC Z respectively, followed by the second character.

If print wheels with less than 96 spokes are installed, ensure that the 88-92-96 print wheel selection switch is properly set.

- Hammer Energy/Ribbon Advance Data (second character) -

The second character contains 4 bits (0 - 3) for ribbon advance and 3 bits (4 - 6) for hammer energy. This provides 16 different size ribbon advances (0 to 15 steps) and 5 different hammer energy levels (0 to 4). The hammer energy level definitions are as follows:

- Level 0 - Select spoke 0, do not fire hammer
- Level 1 - Lowest hammer energy
- Level 2 - Low hammer energy
- Level 3 - High hammer energy
- Level 4 - Highest hammer energy

Caution - Level 4 should be used only after it has been determined that the lower energy levels are inadequate for printing a particular character.

The Hammer Energy/Ribbon Advance character provides a means for the user to tailor print quality and ribbon economy as desired. The general criteria for selecting the proper amount of hammer energy and ribbon advance is to use the lowest hammer energy and the

minimum ribbon advance that will produce a level of print quality suitable for the intended application. Excessive hammer energy levels will unnecessarily shorten the useful life of the affected print wheels.

The Print Wheel Data Book mentioned earlier will prove to be an indispensable aid for determining proper hammer energies and ribbon advance units for any of the Diablo or Xerox print wheels suitable for use on the Model 630. The Data Book lists the recommended hammer energy for each print character on each of the different print wheels. For each of the metalized print wheels, the Data Book also lists a recommended proportional space (PS) unit for each character on the print wheel. In general, the recommended PS unit value for a particular character is also the appropriate ribbon advance unit value to use after printing that character. For the plastic print wheels, which are not assigned PS unit values, a standard ribbon advance unit value of 6 will prove satisfactory in most cases.

4.23.1.9 Cancel Word Processing Options

The sequence ESC X will cancel the following Word Processing modes:

Auto Underscore	Bold Overprint
Shadow Print	Program Mode
Offset Selection	Auto Justify
Auto Center	

Proportional space mode and increased carriage settling time are not cancelled by ESC X.

4.23.1.10 Auto Center

Auto line centering is initiated by the sequence ESC =. Subsequent data is stored in a memory buffer until a carriage return (CR) or a line feed (LF) command is received. The data is then printed centered between the margins and the Model 630 exits the auto center mode. Auto Center allows the line to extend beyond the left and right margins. If Auto Justify was enabled when Auto Center was entered, Auto Center will have precedence for that line only. The sequence ESC X will clear Auto Center. ESC X is not intended as a line terminator, and should not be embedded in a line of text to be auto centered.

4.23.1.11 Auto Justify

Automatic margin justification is initiated by the sequence ESC M. The ESC M should precede the first printable character in a line. Subsequent data is stored in a memory buffer until a carriage return (CR) or a line feed (LF) command is received. The data is then printed justified between the left and right margins. Auto Justify remains enabled until the sequence ESC X is received, or until a break is transmitted or received. The Model 630 then exits the mode.

Auto Justify operates in fixed pitch or proportional space mode. Up to 256 data characters may be included in a line. Note that all communication protocols still function normally. If the LINE EDIT key is on, data from the keyboard will also be printed as it is stored.

Auto Justify begins its justification calculations from the position of the first printable character after the carriage return (CR), line feed (LF), Horizontal Tab (HT), or ESC M sequence. This allows unjustified leading spaces or tabs and allows partial line justification. Auto Justify calculates the number of 1/120" offset units needed to fill out or to condense the line so that it will fit exactly between the first printable character and the right margin. The offset units are then applied, first to the word spaces, and then to the char-

acter and word spaces after the word spaces reach 150% of their normal size. If the offset added to the character spaces exceeds 7 units, the line is printed unjustified.

The following conditions are imposed on the use of ESC sequences while in the Auto Justify mode:

- Any graphics-related ESC sequences are not permitted. (WP options are not functional in graphics.)
- The following ESC sequences are permitted to be used within a line of text while in Auto Justify mode:

ESC U, ESC D	Half Line Feed, Negative Half Line Feed (Exception: Half Line feeds are not permitted across a page boundary.)
ESC HT (n), ESC US (n)	Horizontal Tabs, HMI
ESC Y, ESC Z	Printable ASCII characters
ESC A, ESC B	Print red ribbon, Print black ribbon
ESC E, ESC R	Auto Underscore ON, OFF
ESC W, ESC &	Shadow Print ON, OFF (CR clears)
ESC O, ESC &	Bold Print ON, OFF (CR clears)
ESC %, ESC N	Increased carriage settling time ON, OFF
ESC BS	Backspace 1/120"

- All other ESC sequences are permitted only at the beginning of a line of text (before the first printable character).

4.23.1.12 Line Edit (KSR only)

Line edit mode is selected by LINE EDIT key in the control section of the keyboard. Line editing is a means of verifying and correcting data before it is transmitted. Line edit mode prints and stores keyboard data in the 256 byte edit buffer as it is entered, without transmitting the data. Depressing the DEL key will delete the last character in the edit buffer and backspace the carriage if the deleted character was a printing character or a space. A deleted backspace will cause a forward space. The alarm is sounded if the buffer is empty and the DEL key is depressed. When a carriage return (CR) or line feed (LF) character is entered, a local carriage return-line feed is executed and the data in the edit buffer is transmitted if the terminal is in remote mode, and/or printed if the terminal is in Local or Half-Duplex mode. While the terminal is transmitting, the received data is print queued.

Release of the LINE EDIT key with data in the edit buffer will cause the buffer to empty without transmitting or printing, and will also cause a local carriage return-line feed.

Data may be received while in the Line Edit mode only if the edit buffer is empty or is being transmitted. Otherwise the received data is rejected and the alarm sounds. The only keyboard entries that will empty the buffer are carriage return (CR), line feed (LF), or transitions of the LINE EDIT key.

- NOTE: 1) The control panel switches FF and LF are treated as keyboard data when the LINE EDIT switch is on and keyboard data has been entered. Using the BREAK switch may disrupt LINE EDIT data.
- 2) Margin Control and Line Edit modes are mutually exclusive. Should both switches be depressed at the same time, the alarm will sound and any subsequent key entries will be rejected until the error is cleared (by turning off either switch, LINE EDIT or MARG CONT).

4.23.1.13 Margin Control (KSR only)

Margin Control mode is selected by the MARG CONT key in the keyboard control section. Margin Control is a means of increasing typing throughput by providing automatic carriage returns at appropriate line endings. A carriage return and line feed are provided on the first space or hyphen after entering a "hot zone" of five characters before the right margin. The alarm will sound when the "hot zone" is entered instead of when the right margin is crossed. If in remote, the carriage return and line feed are transmitted. Auto Line Feed and Double Line Feed functions remain the same as with a normal carriage return. The carriage return provided by Margin Control does not clear Bold or Shadow Print modes. It will cause Auto Underscore to operate the same as it does for a normal CR command.

Margin Control can be entered remotely by ESC \$ regardless of the MARG CONT switch setting.

4.23.2 Paper Feed Accessory Support

This portion of the optional firmware is available to support user-supplied accessory paper feed equipment that is compatible with the Model 630.

4.23.3 Remote Diagnostics

The remote diagnostics option allows the interrogation of machine parameters and status through the serial interface.

4.23.3.1 Diagnostic Commands

The following diagnostic commands are included in this option:

ESC SUB I	Initialize the printer (standard in Basic HPRO5)
ESC SUB R	Remote error reset (standard in Basic HPRO5)
ESC SUB 1	Request status byte 1
ESC SUB 2	Request status byte 2
ESC SUB U	Enter user (programmable) test mode
ESC SUB W (n)	Enter wraparound (echo) test mode
ESC SUB X	Exit test mode
DEL	Error correct backspace (user test mode only)
STX	Print buffer once (user test mode only)
SOH	Print buffer repeatedly (user test mode only)

4.23.3.2 Diagnostics Interface Protocol

Status information is not supplied to the interface of any keyboard-equipped Model 630 while it is in the LOCAL mode. All diagnostic commands are processed immediately when received and are not queued. This means all status reported will be the status present at the time the command was received. Only the low 7 bits (bits 0 thru 6) of a status byte are significant. Their equivalent value may range from 0 to 127. The MSB (bit 7) will be a parity bit as defined by the PARITY ENABLE and PARITY EVEN/ODD switches. All commands that generate a response from the Model 630 will result in a status byte being sent to the host computer preceded by an STX character. The rules for ETX/ACK and DC1/DC3 protocols are applicable and should be used for sending status requests to the Model 630.

4.23.3.3 Diagnostic Command Definitions

ESC SUB I

This command will cause the Model 630 to unconditionally execute an initialize sequence regardless of any error conditions that may exist within the printer. This command is executed immediately when received over the interface, unlike the corresponding remote reset sequence ESC CR P which is queued along with other commands. The Model 630 will default to the same conditions that exist at power up. Prior to sending this command, the host should send a nonprinting character to cause the Model 630 to abort any multiple character sequence in progress.

ESC SUB R

This command causes the Model 630 to reset any error conditions. It produces essentially the same result as pressing the RESET switch on the control panel. If the unit is in check, it will execute a restore. Due to internal program latency, the minimum time necessary to reset all errors is 250 milliseconds.

In a situation where the terminal is being operated without a control panel (not typical), a series of up to eight automatic restores occurs if the terminal goes into a check condition. The ESC SUB R sequence has the effect of resetting the automatic restore counter to enable another series of automatic restore operations.

ESC SUB 1

This command will cause the Model 630 to send a status report byte (STATUS 1) thru the interface. The true-state bit definitions for this byte are:

<u>Bit</u>	<u>Status</u>
0	End of Ribbon
1	10 Pitch (This bit false if any other pitch is selected)
2	Paper Out
3	Auto Line Feed enabled (set by switch on control panel, or by ESC sequence if no control panel)
4	Cover Open
5*	Printer Idle (no motion, and print queue empty)
6	Printer In Check
7	Parity Bit **

* Bit 5 represents "Buffer Full" if Options ROM at location F32 on HPRO5 board is at design level earlier than 302839-03 (EROM 100524-02).

** The state of bit 7 is defined by the PARITY ENABLE and PARITY EVEN/ODD switches on the control panel.

ESC SUB 2

This command will cause the Model 630 to send a status report byte (STATUS 2) thru the interface. The true-state definitions for this status byte are:

0	Control Panel Option present	4	Reverse Print Mode (inverted horizontal motion)
1	Diablo Keyboard Option present	5	Paper Out Defeat enabled (always 0 if no control panel)
2	Auto Carriage Return enabled	6	Full-Duplex enabled
3	Double Line Feed enabled (always 0 if no control panel)	7	Parity Bit *

* The state of bit 7 is defined by the PARITY ENABLE and PARITY EVEN/ODD switches on the control panel.

ESC SUB U

This command will cause the Model 630 to enter the USER (programmable) test mode. In this mode the user may enter any command sequence to the Model 630 up to within 5 characters from the end of the buffer. The Model 630 may then be commanded to execute the contents of the print buffer either once or repeatedly. All standard and optional ESC sequences are valid except REMOTE DIAGNOSTIC commands. Any REMOTE DIAGNOSTIC commands in the buffer will be ignored. Both ETX/ACK and DC1/DC3 protocols will function normally when entering data into the buffer. During buffer execution an ACK will be sent thru the serial interface for each ETX encountered in the buffer, if enabled. DC1/DC3 does not function during buffer execution. USER test mode can be exited by issuing either ESC SUB X or ESC SUB I sequence. All other incoming commands will be ignored during buffer execution.

ESC SUB W (n)

This command will cause the Model 630 to enter the WRAPAROUND (echo) test mode. In this mode, the Model 630 will send back to the host computer each byte (n) that it receives, using the same protocol as status commands. The echoing starts with the first byte following the ESC SUB W sequence. The Model 630 will automatically exit WRAPAROUND mode when in LOCAL mode. WRAPAROUND mode can be exited by issuing either ESC SUB X or ESC SUB I sequence. The ESC SUB X sequence will be echoed back to the host computer.

ESC SUB X

This command will cause the Model 630 to exit both WRAPAROUND and USER test modes immediately. When in USER test mode, the Model 630 will finish the execution of the buffer if in progress when the ESC SUB X was received, and will simultaneously accept new data from the interface.

DEL

The DEL or RUBOUT character is used for error correction when entering data into the buffer in USER test mode. The buffer pointer will be backed up one position, and the previous character echoed on the printer for each DEL received. All control characters except SPACE, BACKSPACE, CARRIAGE RETURN and LINE FEED will be echoed as the uppercase ASCII equivalent preceded by an exclamation mark (!). An ESCAPE character will be echoed as a dollar sign (\$). The DEL character is ignored during an ESCAPE sequence, to prevent invalid ESC sequences. If the incoming data is arriving faster than the speed of the print mechanism, the entire RUBOUT and ECHO sequence will be transparent; that is, the buffer pointer will be backed up but the deleted character(s) may not be echoed on the printer.

STX

The STX character will cause the content of the print buffer to be executed one time only, when in USER test mode. If the buffer is being executed repeatedly (SOH character), receiving an STX character will cause the Model 630 to return to single-cycle execution mode at the end of the buffer. The SOH and STX characters may still be used as the third character of a three character sequence in USER test mode. They will not cause the buffer to be executed when included within a valid ESCAPE sequence. Data may no longer be entered into or deleted from the buffer after receiving an SOH or STX execution character without first exiting and then reentering USER test mode. A BREAK in USER test mode will cause the Model 630 to go back to buffer entry mode which allows entering new test data without exiting USER test mode.

SOH

The SOH character will cause the content of the print buffer to be executed repeatedly. The Model 630 will continue buffer execution until being returned to single-cycle execution mode (STX character), or exiting USER test mode (ESC SUB X or ESC SUB I).

4.23.4 "Here Is . . ." and Nonvolatile RAM Option (Expanded HPRO5 Only)

The Nonvolatile RAM option consists of a CMOS RAM and small rechargeable electrical battery installed on the HPRO5 PCB. During power off or power failure, the battery maintains DC power to the CMOS RAM which stores the "Here Is . . ." message and several operating parameters, as described below.

4.23.4.1 "Here Is . . ." (Expanded HPRO5 Only)

If the Nonvolatile RAM option is installed, a "Here Is . . ." message of up to 31 characters can be stored. When an ENQ character is received, or when the control panel switch HERE IS is pressed, the Model 630 will transmit this message. Programming the "Here Is . . ." message is accomplished by turning on the control panel switch labeled MESSAGE LOAD to enter the program "Here Is . . ." mode, and keying in the message. The program "Here Is . . ." mode may also be entered remotely by an ESC (sequence.

The program "Here Is . . ." mode is terminated by turning off the MESSAGE LOAD switch or by ESC).

4.23.4.2 Nonvolatile Parameter Memory (Expanded HPRO5 Only)

Power Up

At power down, the current status of each of the operating parameters listed below is saved in the nonvolatile RAM, to be restored at power up. This status supersedes the default status normally assumed by these parameters at power up or remote reset when the Nonvolatile RAM option is not present.

Auto carriage return flag	Right margin
Auto line feed flag	Left margin
Remote margin flag	Horizontal tabbing increment
Program mode flag	Horizontal spacing increment
Proportional space flag	Vertical tabbing increment
Inverted horizontal motion flag	Vertical spacing increment
Auto backward print enable flag	Carriage Home position
Page size	Print wheel and language selection
Top margin	Red/Black ribbon flag
Bottom margin	Remote HMI flag

Remote Reset (ESC CR P)

Remote reset initializes all of the operating parameters except those listed below. These are considered semi-permanent parameters and their status is preserved. These parameters can be changed only by issuing the appropriate corresponding ESC sequences.

- Auto carriage return flag
- Auto line feed flag
- Inverted horizontal motion flag
- Carriage Home position
- Print wheel and language selection
- Auto backward print enable flag

4.23.5 HyPLOT Vector Plotting

4.23.5.1 Scope

The HyPLOT firmware option enables the Model 630 Terminal to recognize and execute the ESC and Plot command sequences unique to Diablo HyPLOT Vector Plotting. This subsection describes the operation of HyPLOT, and outlines the command sequences which must be supplied by the operator either thru a keyboard or from a host system to produce graphs or vectors.

4.23.5.2 Definition Of Terms

- Default - A "built-in" instruction or value for use by the unit in the absence of a user input on the subject.
- h - The number of increments of horizontal (X) movement (at 1/120" each) between print points along the vector line. Minimum value allowed is 0, maximum is 31. See Table 4-3.
- Plot Point - The basic X-Y coordinate location identified in the HyPLOT command sequence. Each successive plot point establishes the magnitude and direction for the intervening vector.
- Print Point - The individual points along a vector where the plot character is printed. Spacing between individual points, called the precision or resolution of the vector, is determined by the values selected for h and v. Note that the actual print point will be located at the nearest whole increment coincident value of both h and v, and not always exactly on the actual or intended "straight line" of the vector.
- Print Position - The position on the paper form directly in front of the print hammer where the next character may be printed.
- v - The number of increments of vertical (Y) movement (at 1/48" each) between print points along the vector line. Minimum value = 0, maximum = 31. See Table 4-3.
- Vector - A quantity having both magnitude and direction commonly represented by a directed line segment. In HyPLOT the line segment between successive plot points.
- X - Print position (carriage) movement in the horizontal direction (X coordinate), where
+X = Relative movement to the RIGHT (cumulative total cannot exceed the physical limits of the printer - 1572 increments)
-X = Relative movement to the LEFT (remainder cannot be less than 0 or beyond the physical limits of the printer)
Absolute moves do not require a sign. The increment count, which is the horizontal print position address, simply increases to the RIGHT and decreases to the LEFT.

Minimum possible increment of horizontal movement = 1/120".

- Y - Print line (paper) movement in the vertical direction (Y coordinate), where
- +Y = Relative movement DOWN (paper moves UP for positive line feed - cannot exceed the limits set for either lower margin or 548 increments, will cause a Form Feed)
 - Y = Relative movement UP (paper moves DOWN for negative line feed - cannot exceed the TOF or top margin, paper movement will stop)
- Absolute moves do not require a sign. The increment count, which is the print line address, simply increases DOWN (paper UP) and decreases UP (paper DOWN).

Minimum possible increment of vertical movement = 1/48".

4.23.5.3 Description Of HyPLOT Vector Plotting

HyPLOT action begins with the unit receiving a special pattern of ESC codes to enter HyPLOT mode and establish plot parameters. Once in the HyPLOT mode, the unit's print position can be moved to any (X-Y) plot point coordinate within the current page boundaries as defined by the unit's Printing Format instructions. Each such plot point requires a command sequence of not more than 6 bytes. The actual move from one plot point to the next is accomplished in one of two ways; either directly with no plot character printing along the vector, or by a series of carriage and paper feed moves equal to the values of h (horizontal or X plot precision) and v (vertical or Y plot precision) defined in the HyPLOT Mode command sequence and printing the selected plot character at those print points where whole values of h and v occur near the actual "straight line vector" between the plot points. In short, the unit "fills in" the vector line between plot points by printing the plot character at each point along the line spaced according to the values of h and v.

HyPLOT offers two methods of plotting - ABSOLUTE and RELATIVE, with the only difference being the manner in which each plot point is addressed. In the ABSOLUTE Mode, each plot point is addressed in terms of its X/Y location relative to the page ORIGIN (X=0/Y=0). In the RELATIVE Mode, each plot point is addressed in terms of its X/Y displacement from the X/Y location of the preceding plot point.

X-axis (carriage) movement consists of up to a maximum of 1572 total increments of 1/120" each (for 132 column paper) counting to the RIGHT from the ORIGIN. Y-axis (paper feed) movement consists of up to 528 increments of 1/48" each (for 11" long paper) counting DOWN from the ORIGIN. Note that the Y-axis increment count increases in value with the apparent downward movement of the print line, and that X-axis increment count increases in value as the carriage is moved rightward from the origin. Visualizing the vector plotting situation as it is normally perceived with X-Y coordinates, and remembering that all printer plotting is referenced from the origin (the top left corner of the printing format), then vector plotting is always done in the -Y/+X Quadrant, and therefore ALL Y values must be inverted. Note also that all vector plotting must be done within the confines of the four page margins (if any) defined by the unit's current Printing Format instructions, and that the unit assumes the 0/0 page origin print position upon entering HyPLOT Mode, with both X and Y position counters at 0.

4.23.5.4 The HyPLOT Commands

- ESC G Enter HyPLOT ABSOLUTE Mode. All vector plot points are interpreted as absolute locations. Movement commands do not require the sign byte. Draw all vectors except the first, which is a move only.
- ESC G BEL Same as ESC G except draw all vectors including the first one.
- ESC V Enter HyPLOT RELATIVE Mode. All vector plot points are interpreted as relative locations. All movement commands must include a sign byte. Draw all vectors except the first, which is a move only.
- ESC V BEL Same as ESC V except draw all vectors including the first one.
- ESC . (character) Change the vector print character to the selected (character). The default character is the " . ".
- ESC , h v h = horizontal print point resolution or "precision" in increments of 1/120", with a default value of 2. v = vertical print point resolution or "precision" in increments of 1/48", with a default value of 1. Both h and v can be assigned values between 0 and 31 (See Table 4-3). If both h and v = 0 then only the plot points will be drawn (or printed).
- ESC A Ribbon down to print in red (requires 2-color ribbon option).
- ESC B Ribbon up to print in black.
- ESC 4 (or CR) Exit HyPLOT mode.

Table 4-3
ASCII CHARACTERS FOR VALUES OF h AND v

Value	ASCII	Value	ASCII
0	= Space	16	= 0
1	= !	17	= 1
2	= "	18	= 2
3	= #	19	= 3
4	= \$	20	= 4
5	= %	21	= 5
6	= &	22	= 6
7	= '	23	= 7
8	= (24	= 8
9	=)	25	= 9
10	= *	26	= :
11	= +	27	= ;
12	= ,	28	= <
13	= -	29	= =
14	= .	30	= >
15	= /	31	= ?

Table 4-4
CONVERSION - X/Y PLOT INCREMENTS OF MOVE TO BINARY EQUIVALENTS

Bit # → Binary Value	12 2048	11 1024	10 512	9 256	8 128	7 64	6 32	5 16	4 8	3 4	2 2	1 1	PLOT POINT VALUE ↓
X													=
Y													=
	MSB					IB					LSB		

Table 4-5
CONVERSION - X/Y PLOT BINARY EQUIVALENTS TO ASCII BYTE CODE

BYTE	BITS							ASCII
	7	6	5	4	3	2	1	
1. SIGN	0	1	x	x	x			
2. HIY	0	1	5 MSBs of Y					
3. XLOY	1	1	0	2 LSBs of Y		2 LSBs of X		
4. LOY	1	1	5 Intermediate bits of Y					
5. HIX	0	1	5 MSBs of X					
6. LOX	1	0	5 Intermediate bits of X					

Sign Byte : x = doesn't care and Neg sign = 1/Pos sign = 0

Table 4-6
ASCII/BINARY CODE CHART

Bits	b ₇ →	0	0	0	0	1	1	1	1
	b ₆ →	0	0	1	1	0	0	1	1
	b ₅ →	0	1	0	1	0	1	0	1
b ₄ ↓ b ₃ ↓ b ₂ ↓ b ₁ ↓	COLUMN → + ROW ↓	0	1	2	3	4	5	6	7
0000	0	NUL	DLE	SP	0	@	P	'	p
0001	1	SOH	DC1	!	1	A	Q	a	q
0010	2	STX	DC2	"	2	B	R	b	r
0011	3	ETX	DC3	#	3	C	S	c	s
0100	4	EOT	DC4	\$	4	D	T	d	t
0101	5	ENQ	NAK	%	5	E	U	e	u
0110	6	ACK	SYN	&	6	F	V	f	v
0111	7	BEL	ETB	'	7	G	W	g	w
1000	8	BS	CAN	{	8	H	X	h	x
1001	9	HT	EM	}	9	I	Y	i	y
1010	10	LF	SUB	*	:	J	Z	j	z
1011	11	VT	ESC	+	;	K	[k	{
1100	12	FF	FS	,	<	L	\	l	
1101	13	CR	GS	-	=	M]	m	}
1110	14	SO	RS	.	>	N	^	n	~
1111	15	SI	US	/	?	O	_	o	DEL

4.23.5.5 Basic HyPLOT Procedure

Following are the step by step procedures used to create the composite ABSOLUTE/-RELATIVE Vector Plot Example shown in Figure 4-10. The reader is encouraged to use the forms shown as Tables 4-4, 4-5 and 4-6 as aids in gaining expertise in HyPLOT application. The HyPLOT Worksheet at the end of this subsection includes blank copies of Tables 4-4 and 4-5. The blank worksheet can be copied and used as an aid when formulating the command sequences required to produce a desired plot, as demonstrated in HyPLOT Example A and HyPLOT Example B.

The graph scale shown in Figure 4-10 is 35 character spaces wide x 12/120" increments per character (10 pitch) = 420/120" increments. It is 18 line spaces high x 8/48" increments per line space (6 lines per inch) = 144/48" increments. The graph scale is located on the page so that the 0/0 scale point ("A") is located at 21 x 12 = 252 increments horizontally (X) and 15 x 8 = 120 increments vertically (+Y) FROM the "x" in the top left corner which defines the 0/0 point or origin on the page. The printer assumes the "x" or 0/0 ORIGIN position upon entering the HyPLOT Mode, and the first vector plotting move must always be in a +Y or DOWNWARD direction and a +X direction RIGHT away from the origin. The printer will not execute negative going commands from the 0/0 page starting position.

(1.0) FIRST PLOT - ABSOLUTE MODE

- (1.1) Initiate HyPLOT in ABSOLUTE MODE: ESC G
(The first plot is a MOVE ONLY from 0/0 ORIGIN to 0/0 SCALE ("A"))
Set Plot Character to lower case a: ESC . a
Set Plot Precision to 4 x default or 8h and 4v: ESC , (\$
(Refer to Table 4-3 for ASCII characters)
Set Print in Black: ESC B

The resultant command sequence becomes ESC G ESC . a ESC , (\$ ESC B

- (1.2) Send plot command for MOVE ONLY vector to plot point "A"
The required move is 252 increments +X and 120 increments +Y.
This is an ABSOLUTE HyPLOT Vector, therefore the sign byte is not required and the increment count FROM the ORIGIN is the plot point address. The use of the forms in Tables 4-4, 4-5 and 4-6 illustrates the development of the command sequence for plot point "A", which becomes the 5 byte sequence SP ` ~ ! _ (See HyPLOT Example A).

Upon receipt of the last command character (#6 in the required sequence - #1 being ignored) the printer will execute the command and move its print position to vector plot point "A".

- (1.3) Following this same procedure, vector commands are developed and sent for plot points "B", "C", "D" and "E". Following the initial no-print MOVE ONLY vector, the printer will print the selected plot character "a" along the vector between the several remaining plot points spaced according to the h and v values selected.

Send commands for vector to plot point 5/5, or "B" (Use HyPLOT Worksheet)
SP ` t]

Send commands for vector to plot point 7.5/10, or "C" (Use HyPLOT Worksheet)
SP ` j # L

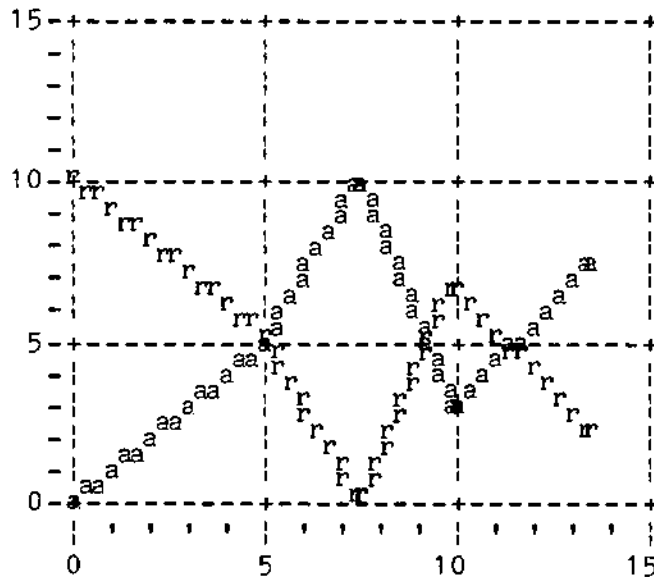

Figure 4-10. ABSOLUTE/RELATIVE VECTOR PLOT EXAMPLE

Send commands for vector to plot point 10/3, or "D" (Use HyPLOT Worksheet)
 SP ` x # [

Send commands for vector to plot point 13.5/7.5, or "E" (Use HyPLOT Worksheet)
 SP ` o \$ P

It should be noted that in the ABSOLUTE mode, if bytes 2, 3, 4 or 5 do not change from one plot point to the next they need not be sent. Only the changed bytes AND byte 6 need be sent.

(1.4) Exit HyPLOT Mode with a carriage return (CR). ESC 4 also works, but a CR exits HyPLOT and also moves the carriage to the left margin.

(1.5) Send 7 negative line feed commands (ESC LF) and 1 negative $\frac{1}{2}$ line feed (ESC D) to return the printer's print position to the 0/0 page ORIGIN position.

(2.0) SECOND PLOT - RELATIVE MODE

(2.1) Initiate HyPLOT in RELATIVE Mode: ESC V
 (The first plot is a MOVE ONLY from 0/0 ORIGIN to 0/10 SCALE ("F"))
 Set Plot Character to lower case r: ESC . r
 Set Plot Precision to 4 x default or 8h and 4v: ESC , (\$
 (Refer to Table 4-3 for ASCII Characters)
 Set to print in black: ESC B

The resultant command sequence becomes ESC V ESC . r ESC , (\$ ESC B

(2.2) Send plot command for MOVE ONLY vector to plot point "F".
 The required move is 252 increments of +X and 40 increments of +Y.
 This is a RELATIVE HyPLOT Vector Plot, and ALL 6 BYTES must be sent for each plot point - including the sign byte. Again, the use of the forms in Tables 4-4, 4-5 and 4-6 illustrates the development of the command sequence for plot point "F", which becomes the 6 byte sequence < SP ` j ! _ (See HyPLOT Example B).

Upon receipt of the last command (#6 in the required sequence) the printer will execute the command and move its print position to plot point "F".

- (2.3) Following this same procedure, vector commands are developed and sent for plot points "G", "H", "I" and "J". Note that these are RELATIVE moves, and each command includes ONLY the increments of + or -X and + or -Y needed to move to the next plot point. Following the initial no-print MOVE ONLY vector, the printer will print the selected plot character "r" along the vectors between the several remaining plot points spaced according to the h and v values selected.

Send commands for vector to plot point 5/5, or "G" (Use HyPLOT Worksheet)
SP SP ^ j SP ^

Send commands for vector to plot point 7.5/0, or "H" (Use HyPLOT Worksheet)
SP SP ^ j SP O

Send commands for vector to plot point 10/7, or "I" (Use HyPLOT Worksheet)
" SP ^ m SP O

Send commands for vector to plot point 13.5/2.5, or "J" (Use HyPLOT Worksheet)
SP SP ^ i SP U

- (2.4) Exit HyPLOT Mode with a carriage return (CR). ESC 4 works, but leaves the carriage in last plot point position. This would require backspaces as well as line feeds to move the print position to the next print line for any follow-on text.

Upon exiting HyPLOT Mode, the printer will "remember" its current print line relative to the T-O-F.

4.23.5.6 Summary

HyPLOT LIMITS:

Attempts to plot beyond a format margin or mechanical printer limit are not allowed for the following reasons.

- +X beyond the right margin - the alarm sounds. Carriage movement and printing can continue.
- +X beyond 1572 increments - the carriage stops at the mechanical limit. Paper feed and printing can continue.
- X beyond the origin - carriage stops at the left limit. Paper feed and printing can continue.
- +Y beyond the lower margin or page end - printer automatically executes a FF to the top margin or TOF for the next page or form.
- Y beyond the origin - ABSOLUTE - the printer does not recognize the sign byte and cannot be commanded to move negatively (up) beyond 0.
- Y beyond the origin - RELATIVE - paper feed down stops at origin or TOF or top margin. Carriage movement and printing continue.

HyPLOT CHARACTER VARIATIONS:

The calculated plot point is always located in the center of the printer's character print space. Use of a "+" or "X" or similar character as the plot character will place the symbol's cross point at the calculated plot point. Use of a "." or a "," or other similar character places the center of the symbol somewhat below the calculated plot point. No set value can be given for this offset since it will vary between type styles and pitch settings. The user will be required to determine this value for the print wheel to be used and include it in when calculating the Y values for plot points.

DATA EXCHANGE FORMAT:

The X and Y values for each plot point must be reduced to corresponding incremental values by the host system. The host system must then operate on these values to render them in the required six byte series of HyPLOT commands acceptable to the HyPLOT-equipped Model 630 (See Tables 4-4 and 4-5). The Model 630 accepts HyPLOT data input in the form of the binary equivalent of ASCII characters making up 7-bit data bytes. The byte sequence given must be followed in either mode, except that in the ABSOLUTE Mode the sign byte is not sent and only those bytes which change from plot point to plot point need be sent - but EACH sequence MUST include the LOX or last (or 6th) byte whether it has changed or not. The printer reads the 6th byte as the execute command for the plot point being transmitted.

THE FULL ASCII COMMAND SEQUENCE FOR THE TWO PLOTS GIVEN:

ESC G ESC . a ESC , (\$ ESC B	= Set ABSOLUTE HyPLOT Mode & parameters
SP ^ ~ !	= Command Plot Point A X=252/Y=120
SP ^ t "]	= Command Plot Point B X=372/Y=80
SP ^ j # L	= Command Plot Point C X=432/Y=40
SP ^ x # [= Command Plot Point D X=492/Y=96
SP ^ o \$ P	= Command Plot Point E X=576/Y=60
ESC CTRL LF 7 times then ESC D	= Command Sequence to return Print Position to origin
ESC V ESC . r ESC , (\$ ESC B	= Set RELATIVE HyPLOT Mode & parameters
< SP ^ j !	= Command Plot Point F X=252/Y=+40
SP SP ^ j SP ^	= Command Plot Point G X=120/Y=+40
SP SP ^ j SP O	= Command Plot Point H X=60/Y=+40
" SP ^ m SP O	= Command Plot Point I X=60/Y=-56
SP SP ^ i SP U	= Command Plot Point J X=84/Y=+36
CR	= Exit HyPLOT Mode

x

HyPLOT EXAMPLE A

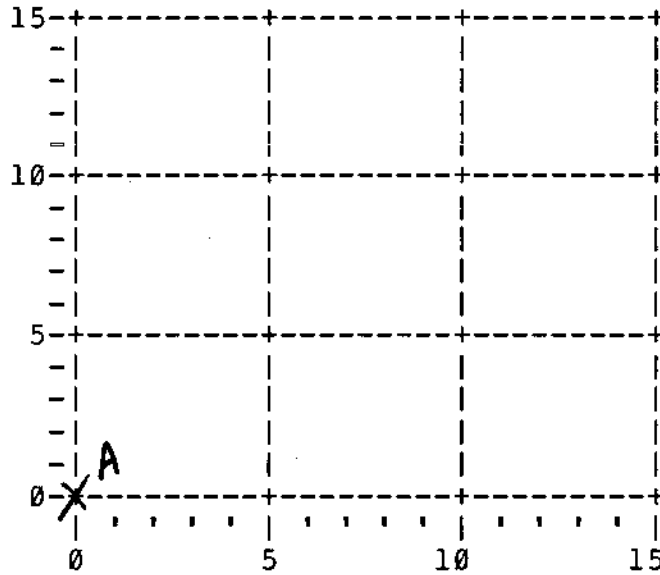

PLOT POINT A

X = 252

Y = 120

ABSOLUTE

TABLE 4-4A
CONVERSION - X/Y PLOT INCREMENTS OF MOVE-TO-BINARY EQUIVALENTS

Bit # → Binary Value	12 2048	11 1024	10 512	9 256	8 128	7 64	6 32	5 16	4 8	3 4	2 2	1 1	PLOT POINT VALUE ↓
X	0	0	0	0	1	1	1	1	1	1	0	0	= 252
Y	0	0	0	0	0	1	1	1	1	0	0	0	= 120
	MSB					IB					LSB		

TABLE 4-5A
BINARY TO ASCII

BYTE	BITS							ASCII
	7	6	5	4	3	2	1	
1. SIGN	0	1	x	x	x	—	—	—
2. HIY	0	1	0	0	0	0	0	SP
3. XLOY	1	1	0	0	0	0	0	~
4. LOY	1	1	1	1	1	1	0	~
5. HIX	0	1	0	0	0	0	1	!
6. LOX	1	0	1	1	1	1	1	—

X = DON'T CARE

COMMAND: SP ~ ! _

HyPLOT EXAMPLE B

PLOT POINT F

X = 252

Y = 40

RELATIVE

x

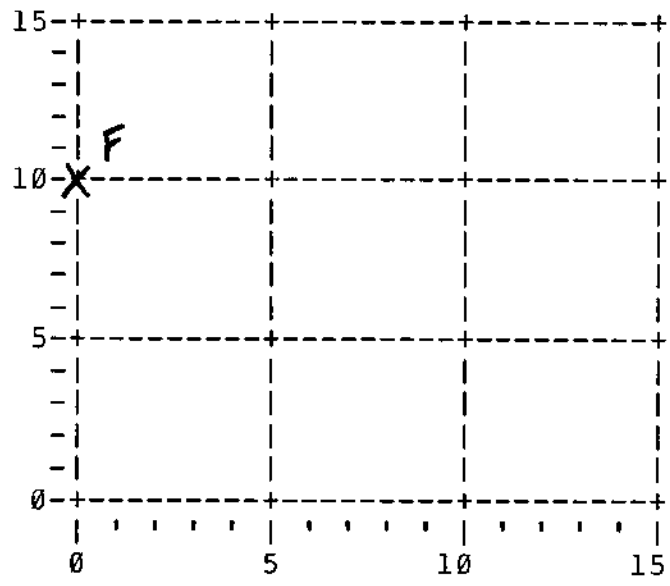

**TABLE 4-4B
CONVERSION - X/Y PLOT INCREMENTS OF MOVE-TO-BINARY EQUIVALENTS**

Bit # → Binary Value	12 2048	11 1024	10 512	9 256	8 128	7 64	6 32	5 16	4 8	3 4	2 2	1 1	PLOT POINT VALUE ↓
X	0	0	0	0	1	1	1	1	1	1	0	0	= 252
Y	0	0	0	0	0	0	1	0	1	0	0	0	= 40
	MSB					IB					LSB		

**TABLE 4-5B
BINARY TO ASCII**

BYTE	BITS							ASCII
	7	6	5	4	3	2	1	
1. SIGN	0	1	x	x	x	0	0	<
2. HIY	0	1	0	0	0	0	0	SP
3. XLOY	1	1	0	0	0	0	0	'
4. LOY	1	1	0	1	0	1	0	j
5. HIX	0	1	0	0	0	0	1	!
6. LOX	1	0	1	1	1	1	1	_

X = DON'T CARE

COMMAND: < SP ' j ! _

HyPLOT WORKSHEET

PLOT POINT _____

(Reproduce as needed)



X = _____

Y = _____

User should make use of a grid scale which matches the intended vector plot.

TABLE 4-4C
CONVERSION - X/Y PLOT INCREMENTS OF MOVE-TO-BINARY EQUIVALENTS

Bit # → Binary Value	12 2048	11 1024	10 512	9 256	8 128	7 64	6 32	5 16	4 8	3 4	2 2	1 1	PLOT POINT VALUE ↓
X													=
Y													=
	MSB					IB					LSB		

TABLE 4-5C
BINARY TO ASCII

BYTE	BITS							ASCII
	7	6	5	4	3	2	1	
1. SIGN	0	1	x	x	x			
2. HIY	0	1						
3. XLOY	1	1	0					
4. LOY	1	1						
5. HIX	0	1						
6. LOX	1	0						

X = DON'T CARE

COMMAND: _____

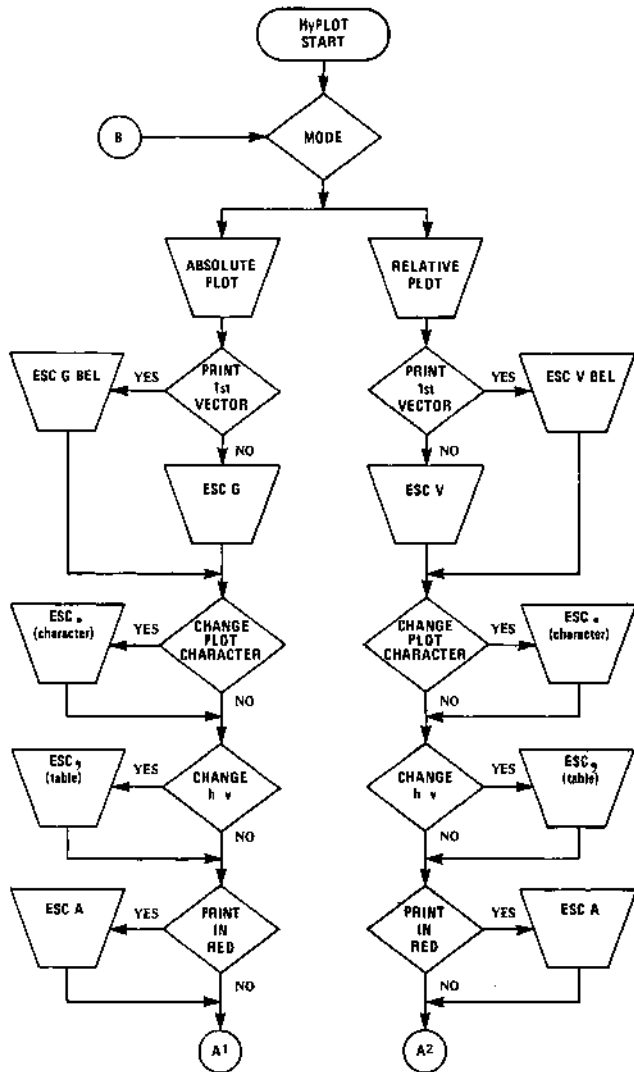

INITIATE HyPLOT - SET MODE & PARAMETERS

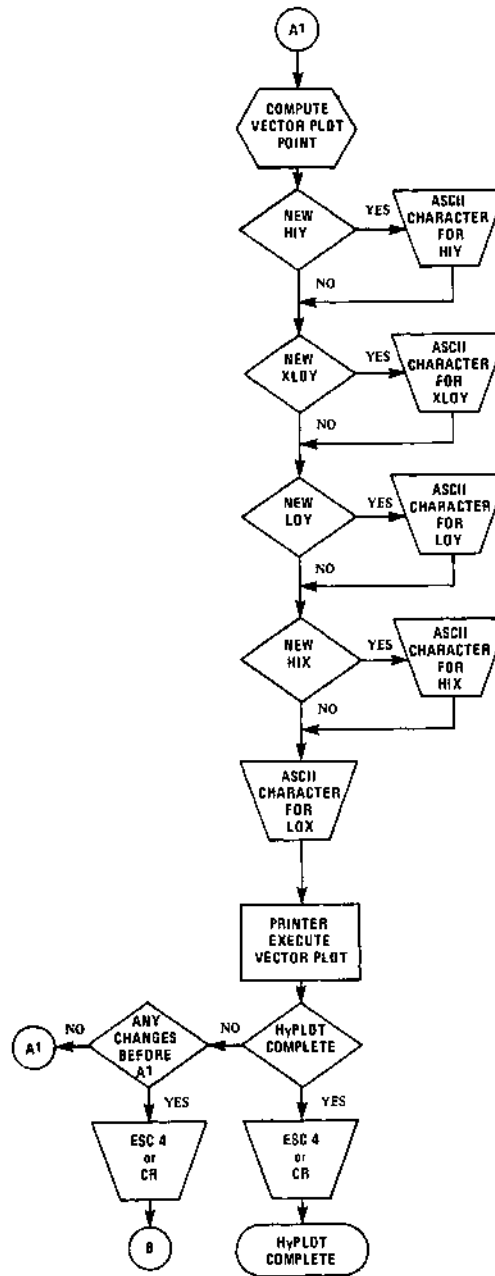

PLOT ABSOLUTE VECTORS

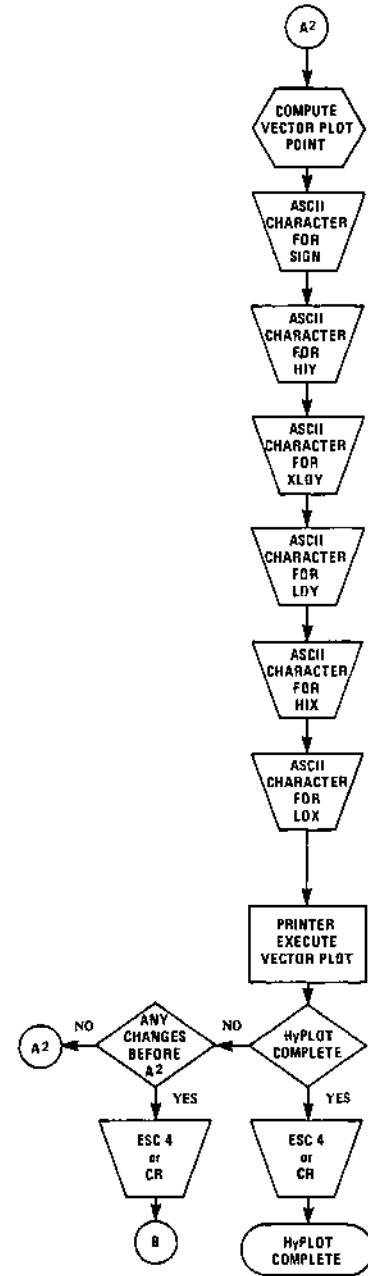

PLOT RELATIVE VECTORS

Figure 4-11
HyPLOT FLOWCHART

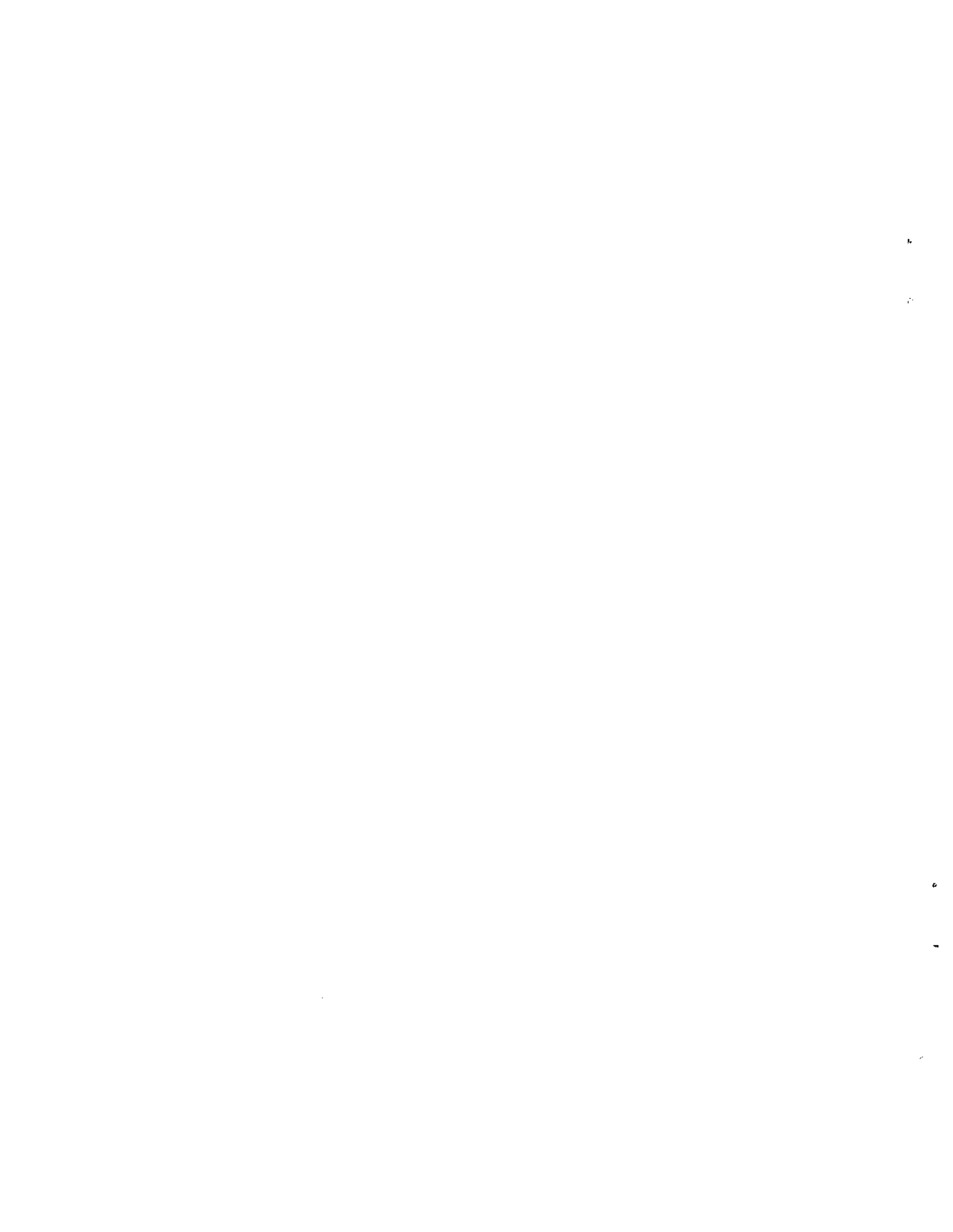

SECTION 5

OPERATING REFERENCES

This section contains various charts, tables and diagrams supporting Section 4, OPERATING CONSIDERATIONS.

5.1 ASCII CODING SYSTEM

The ASCII Coding System is based on the American National Standard Code for Information Interchange, Standard No. X3.4-1977 of the American National Standards Institute, Inc.

Bits		b7 →	0	0	0	0	1	1	1	1		
		b6 →	0	0	1	1	0	0	1	1		
		b5 →	0	1	0	1	0	1	0	1		
b4 ↓	b3 ↓	b2 ↓	b1 ↓	COLUMN →	0	1	2	3	4	5	6	7
↑ROW↑												
0	0	0	0	0	NUL	DLE	SP	0	@	P	'	p
0	0	0	1	1	SOH	DC1	!	1	A	Q	a	q
0	0	1	0	2	STX	DC2	"	2	B	R	b	r
0	0	1	1	3	ETX	DC3	#	3	C	S	c	s
0	1	0	0	4	EOT	DC4	\$	4	D	T	d	t
0	1	0	1	5	ENQ	NAK	%	5	E	U	e	u
0	1	1	0	6	ACK	SYN	&	6	F	V	f	v
0	1	1	1	7	BEL	ETB	'	7	G	W	g	w
1	0	0	0	8	BS	CAN	(8	H	X	h	x
1	0	0	1	9	HT	EM)	9	I	Y	i	y
1	0	1	0	10	LF	SUB	*	:	J	Z	j	z
1	0	1	1	11	VT	ESC	+	;	K	[k	{
1	1	0	0	12	FF	FS	,	<	L	\	l	:
1	1	0	1	13	CR	GS	-	=	M]	m	}
1	1	1	0	14	SO	RS	.	>	N	^	n	~
1	1	1	1	15	SI	US	/	?	O	_	o	DEL

All characters in these two columns and SP (Space) are nonprinting. DEL (Delete) does not print in Remote mode. However, when DEL is entered on keyboard in Local mode, it prints the print wheel character addressed by ASCII code 7F (HEX) when operating with plastic print wheels, or 3F (HEX) when operating with metal print wheels. (This character is also printed in place of characters received with parity or framing error.) When UPPERCASE ONLY is used, shaded lowercase characters (columns 6 & 7) from keyboard are converted to their uppercase equivalents (columns 4 & 5) before being printed or transmitted.

Figure 5-1. ASCII CODE CHART

5.2 KEYBOARDS

There are several different keyboards available for the Model 630. These include two different English language keyboards (a Typewriter Paired array and a Logic Bit Paired array), four foreign language keyboards and an APL keyboard. These are all 47-key keyboards.

Starting in Figure 5-2, each of the available keyboards is shown. The format of the APL keyboard diagram is slightly different to also show the engraving on the front of the keytops. These legends depict the different characters printed when a "standard" print wheel is used in place of an APL print wheel. Bear in mind that the characters shown in the keyboard drawings will be printed only if the appropriate print wheel is installed. Page 5-10 contains a table listing the characters and codes produced by each of the keys in ASCII and APL modes.

Typewriter Paired keyboards are designed to closely follow the format and operation of a standard office typewriter. These keyboards offer ease of operation by non-terminal trained operators.

Logic Bit Paired keyboards can follow the format and operation of other data entry equipment such as teletype terminals. The appropriate keytops on Diablo's Logic Bit Paired keyboards include engravings for these special assignments, including CTRL characters.

Keyboard language selection in the Model 630 is determined by four diode positions on the keyboard PCB. These diode positions are designated as A, B, C and D. The table below lists the diode pattern for each keyboard language. Interpretation of the diode pattern for language selection occurs at power-up of the Model 630.

DIODE				<u>KEYBOARD LANGUAGE</u>
<u>A</u>	<u>B</u>	<u>C</u>	<u>D</u>	
1	0	0	0	Typewriter Paired
1	1	1	1	Logical Bit Paired
0	0	0	1	APL
1	0	0	1	French Azerty
1	1	0	1	Scandinavian
0	1	0	1	German
0	0	1	1	Norsk

"1" = Diode installed

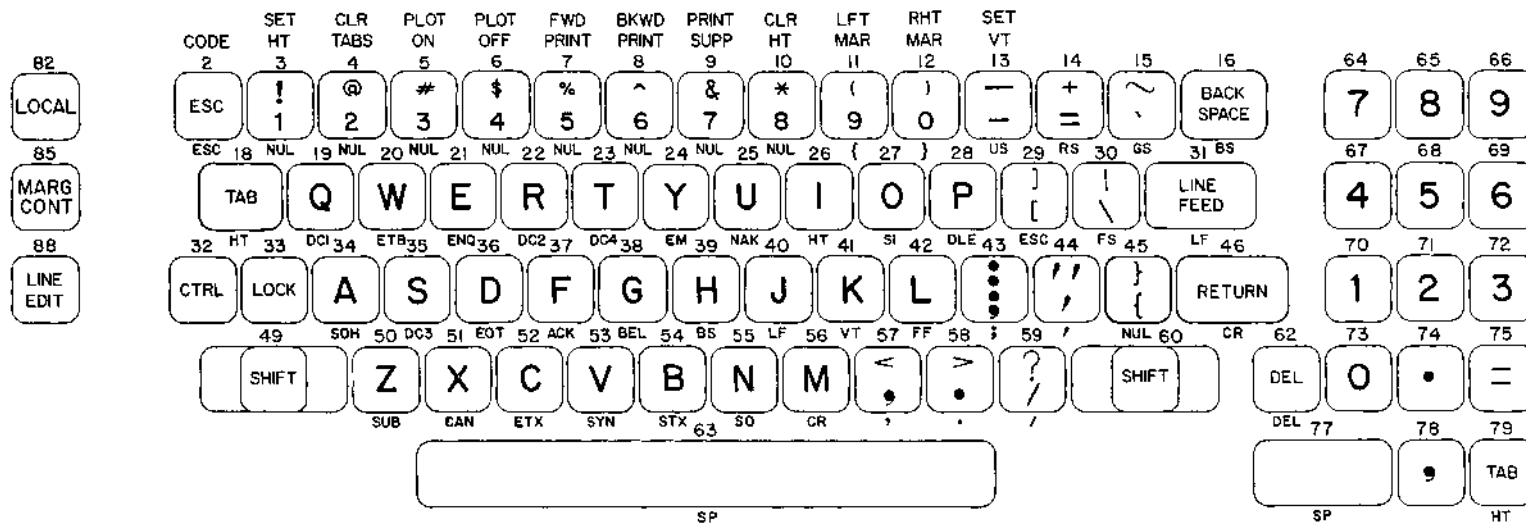

NOTES: CONTROL CODES AND SPECIAL SYMBOLS REFERENCED BELOW KEYTOPS IDENTIFY "CTRL" MODE OUTPUT. THESE LEGENDS ARE NOT ENGRAVED ON KEYTOPS.

Figure 5-2. 47-KEY TYPEWRITER PAIRED ASCII KEYBOARD

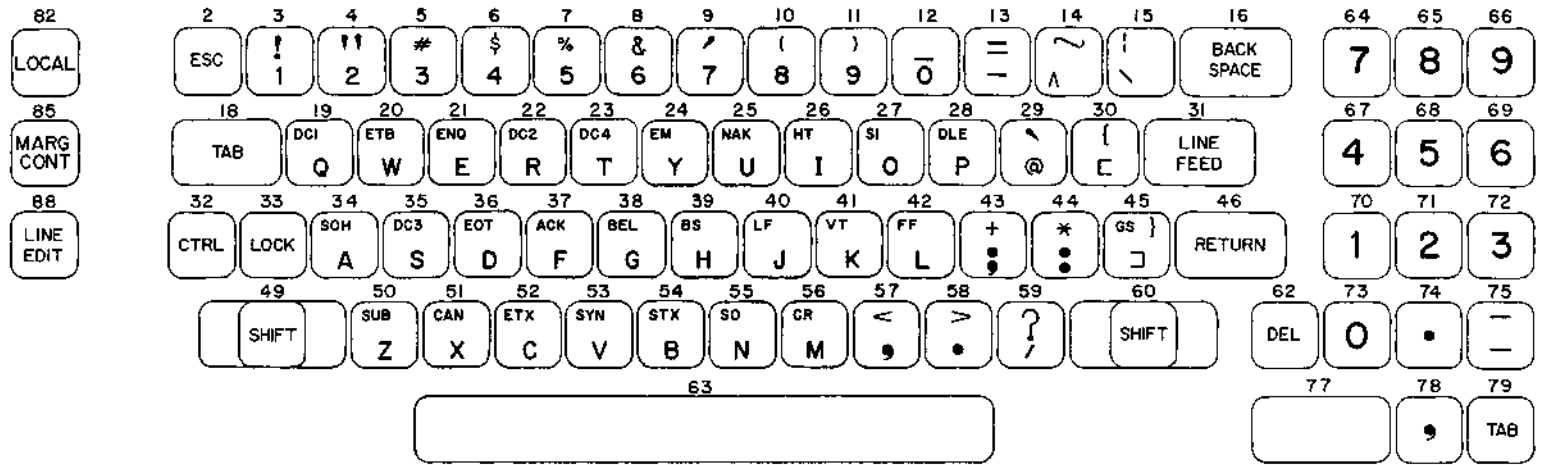

Figure 5-3. 47-KEY LOGICAL BIT PAIRED KEYBOARD

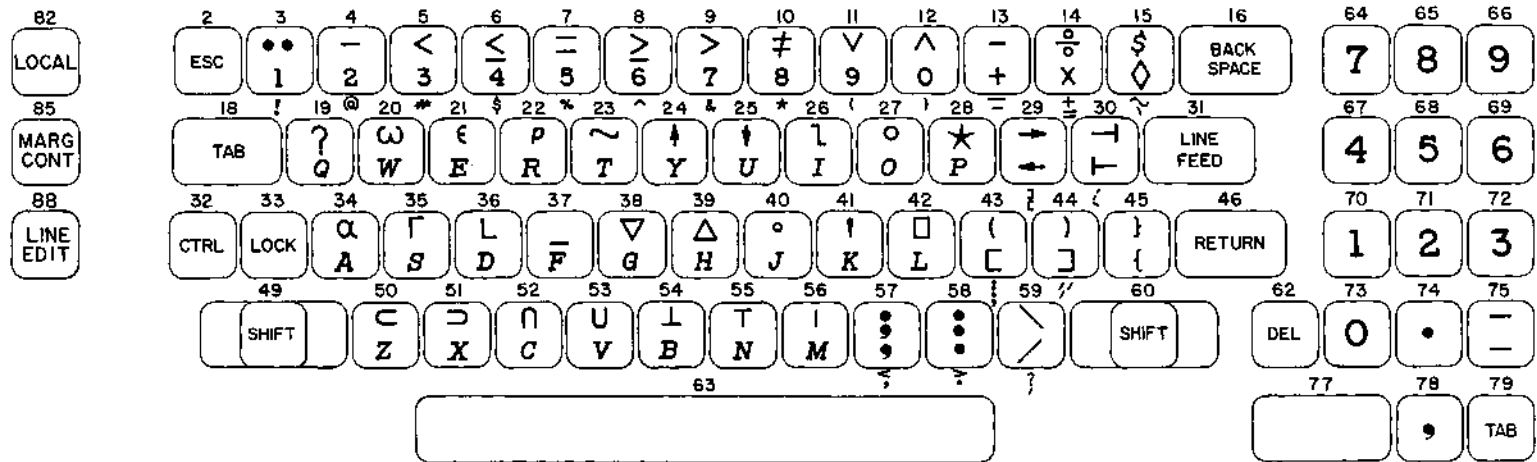

Figure 5-4. 47-KEY APL KEYBOARD

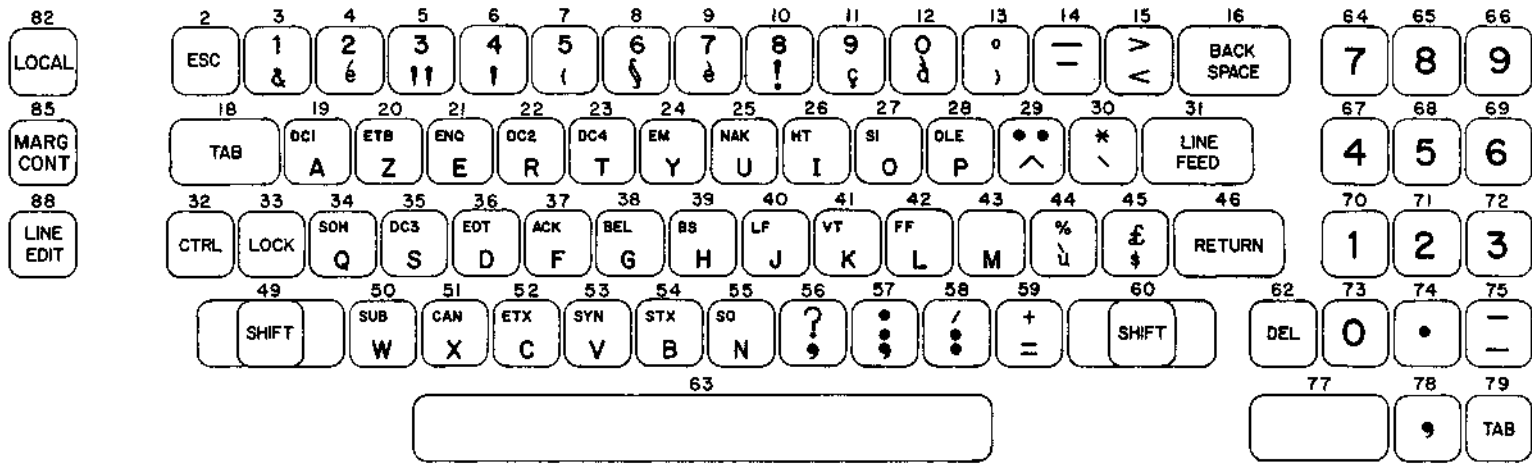

Figure 5-5. 47-KEY FRENCH AZERTY KEYBOARD

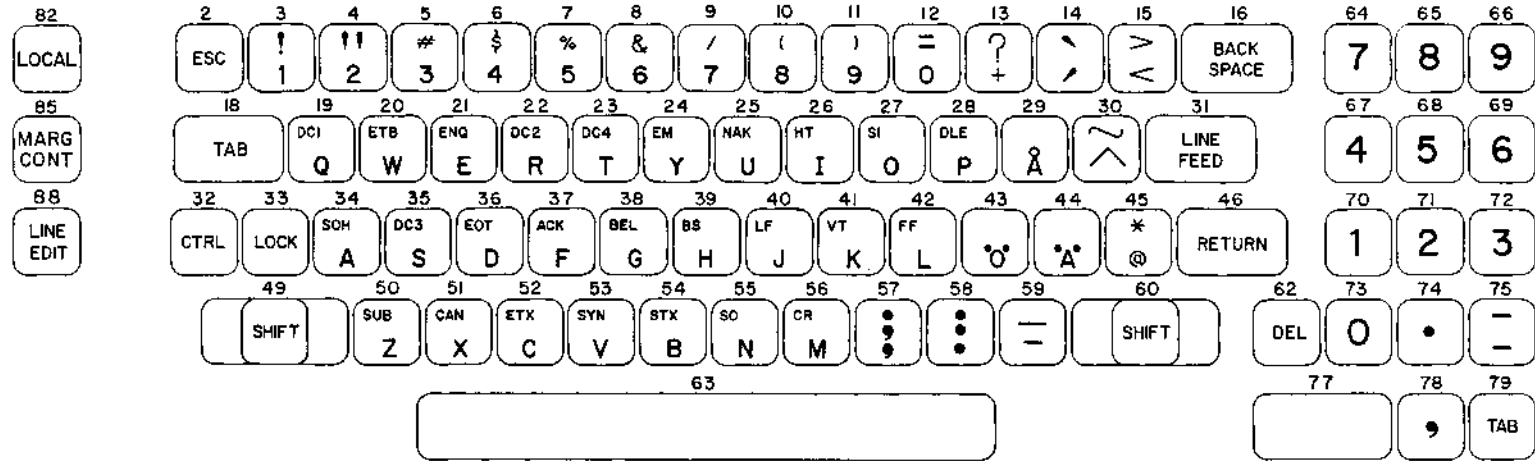

Figure 5-6. 47-KEY SCANDINAVIAN KEYBOARD

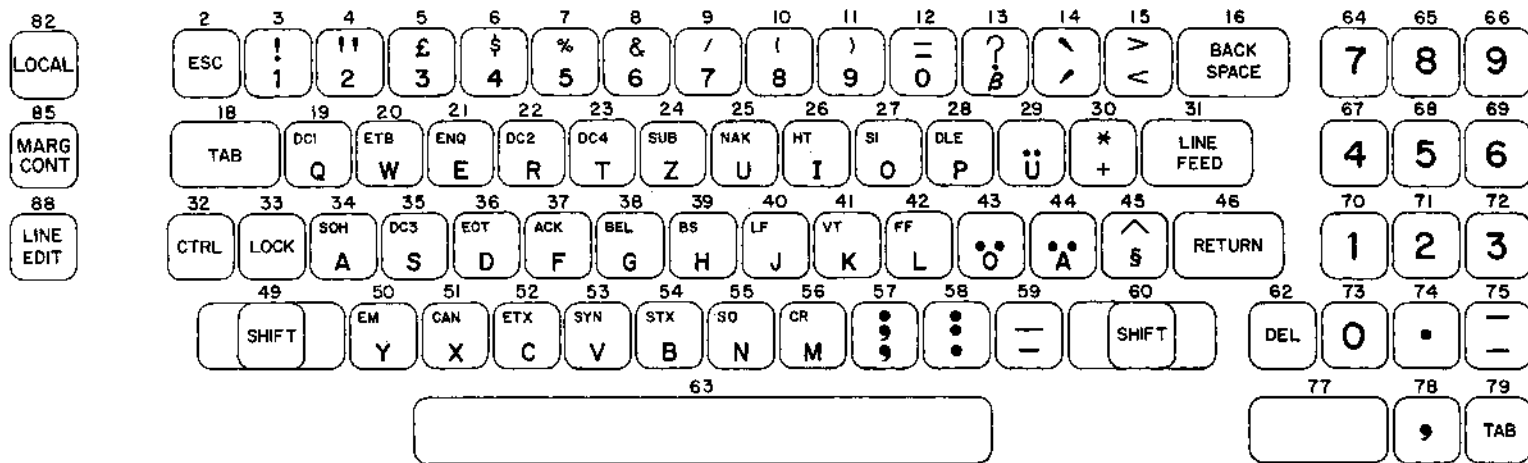

Figure 5-7. 47-KEY GERMAN KEYBOARD

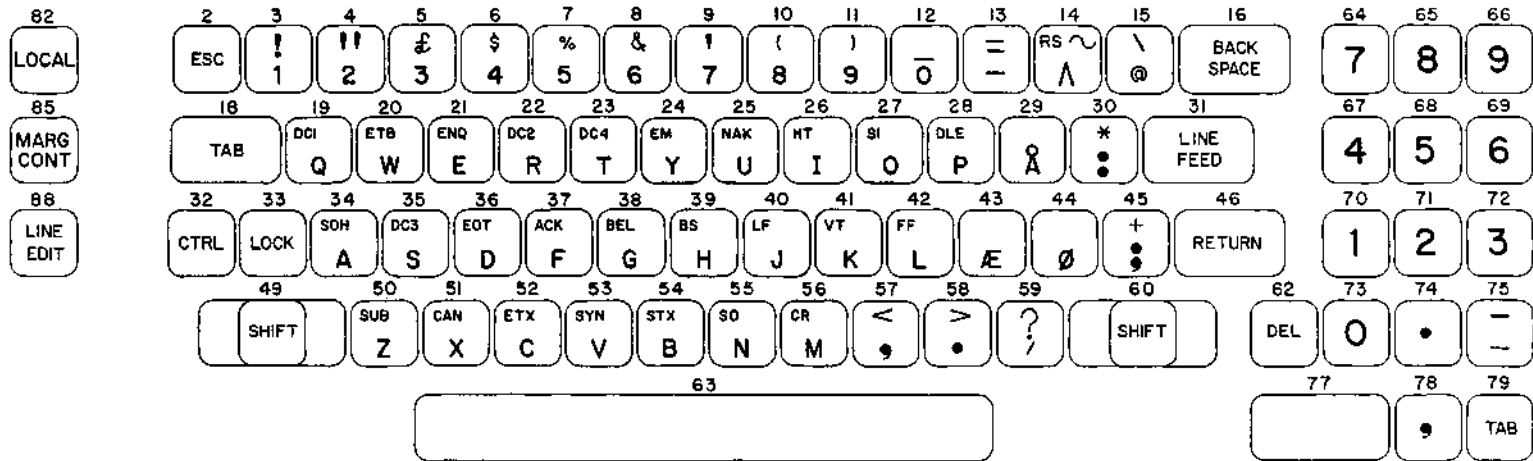

Figure 5-8. 47-KEY NORSK KEYBOARD

Table 5-1
47-KEY TYPEWRITER PAIRING KEYBOARD ASCII/APL MODE
FOR PLASTIC (or Metalized) PRINT WHEELS

Key Position	Unshifted		Shifted			Control		
	Characters		Characters		Hexadecimal	Characters		Hexadecimal
	ASCII	APL	ASCII	APL	Code	ASCII	APL	Code
1								
2 ¹		ESC		ESC	1B		ESC	1B
3		1	!	~	21		NUL	00
4		2	@	~	40		NUL	00
5		3	#	~	23		NUL	00
6		4	\$	~	24		NUL	00
7		5	%	~	25		NUL	00
8		6	^	~	5E		NUL	00
9		7	&	~	26		NUL	00
10		8	*	~	2A		NUL	00
11		9	(~	28	{		7B
12		0)	~	29	}		7D
13	-	+	_	~	5F	US		1F
14	=	x	~	~	2B	RS		1E
15	\	o	~	~	7E	GS		1D
16	BS		BS		08	BS		08
17								
18	HT		HT		09	HT		09
19	q	Q	Q	?	51	DC1		11
20	w	W	W	ω	57	ETB		17
21	e	E	E	ε	45	ENQ		05
22	r	R	R	ρ	52	DC2		12
23	t	T	T	τ	54	DC4		14
24	y	Y	Y	ι	59	EM		19
25	u	U	U	ι	55	NAK		15
26	i	I	I	ι	49	HT		09
27	o	O	O	ο	4F	S1		0F
28	p	P	P	*	50	DLE		10
29	[]]	~	5D(3E)	ESC		1B
30	\]]	~	7C(5C)	FS		1C
31	LF		LF		0A	LF		0A
32	CTRL		CTRL			CTRL		
33	LOCK		LOCK			LOCK		
34	a	A	A	α	41	SOH		01
35	s	S	S	σ	53	DC3		13
36	d	D	D	Δ	44	EOT		04
37	f	F	F	∇	46	ACK		06
38	g	G	G	∇	47	BEL		07
39	h	H	H	Δ	48	BS		08
40	j	J	J	ο	4A	LF		0A
41	k	K	K	ο	4B	VT		0B
42	l	L	L	ο	4C	FF		0C
43	;	;	;	{	3A			3B
44	'	'	'	}	22			27
45	{	{	}	}	7D(7B)	NUL		00
46	CR		CR		0D	CR		0D
47								
48								
49	SHIFT		(SHIFT)			(SHIFT)		
50								
51	z	Z	Z	Σ	5A	SUB		1A
52	x	X	X	Σ	58	CAN		18
53	e	C	C	∩	43	ETX		03
54	v	V	V	∩	56	SYN		16
55	b	B	B	∩	42	STX		02
56	n	N	N	∩	4E	SO		0E
57	m	M	M	∩	4D	CR		0D
58	,	,	<	:	3C	,		2C
59	/	/	>	:	3E(27)	/		2E
60	SHIFT		?	:	3F	/		2F
61			(SHIFT)			(SHIFT)		
62	DEL/- ²		DEL		7F	DEL		7F
63	SP		SP		20	SP		20
64	7		7		37	7		37
65	8		8		38	8		38
66	9		9		39	9		39
67	4		4		34	4		34
68	5		5		35	5		35
69	6		6		36	6		36
70	1		1		31	1		31
71	2		2		32	2		32
72	3		3		33	3		33
73	0		0		30	0		30
74	.		.		2E	.		2E
75	-	+	-	+	2D	-	+	2D
76								
77	SP		SP		20	SP		20
78	,		,		2C	,		2C
79	HT		HT		09	HT		09

1 - Non-Repeat Key
2 - Printed Character in LOCAL Mode (operating with plastic wheel)
3 - Character at 20 and 7F are accessed by an ESC Y or ESC Z routine.

5.3 PRINT WHEEL CODE CHARTS (Typical)

These charts provide a general sample of technical data for the different types of print wheels. Specific technical data pertaining to each print wheel available from Diablo Systems is contained in the Diablo Printer Supplies Catalog, Publication No. 90007-XX.

The codes 20 (Hex) and 7F (Hex) are interpreted as "space" and "delete" respectively by the Model 630 and thus are not available for print wheel addressing. In place of these two codes, the ESC sequences ESC Y and ESC Z are used to address certain characters and thus provide a complete set of 96 codes for print wheel addressing. ESC Y and/or ESC Z are listed on the following charts where applicable.

ESC Y	
⌘	2 94
	3

ESC Z	
↵	1 95
	1

(MSB) b7				0				1				0				1				0				1																						
				b6				1				0				1				0				1																						
b4				b3				b2				b5				0				1				0				1																		
												0				1				0				1				0				1														
0	0	0	0	0	0	0	0	SP					0				37	59	@					62	34	P					26	70	,					56	40	p					90	6
0	0	0	1	1	88	28	2	!					33	63	A					11	85	Q					27	69	a					84	12	q					92	4				
0	0	1	0	0	70	26	2	"					34	62	B					8	68	R					13	83	b					78	18	r					81	15				
0	0	1	1	1	46	50	3	#					35	61	C					10	86	S					14	82	c					79	17	s					88	8				
0	1	0	0	0	44	52	3	\$					36	60	D					22	74	T					16	80	d					76	20	t					86	10				
0	1	0	1	1	47	49	3	%					32	58	E					15	81	U					23	73	e					83	13	u					91	5				
0	1	1	0	1	69	27	3	&					39	57	F					9	67	V					30	66	f					89	7	v					73	23				
0	1	1	1	1	54	42	1	'					40	56	G					24	72	W					4	92	g					74	22	w					0	0				
1	0	0	0	0	60	36	2	(41	55	H					17	79	X					32	64	h					87	9	x					75	21				
1	0	0	1	1	56	38	2)					42	54	I					20	76	Y					25	71	i					85	11	y					94	2				
1	0	1	0	0	61	35	3	*					12	84	J					29	67	Z					7	89	j					72	24	z					95	1				
1	0	1	1	1	45	51	2	+					31	65	K					28	68	[53	43	k					93	3	{					49	47				
1	1	0	0	0	3	93	1	,					57	39	L					21	75	\					63	33	l					77	19	l					59	37				
1	1	0	1	1	43	53	1	-					48	48	M					6	90]					51	45	m					71	25	}					67	29				
1	1	1	0	0	5	91	1	.					50	46	N					19	77	^					64	32	n					82	14	~					52	44				
1	1	1	1	1	68	30	2	/					65	31	O					18	78	_					55	41	o					80	16	DEL										

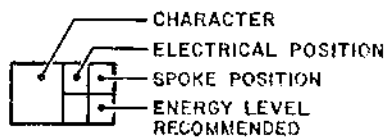

NOTES:

1. USE ENERGY SWITCH POSITION M FOR NORMAL USE, FOR MULTISTACK.
2. DESIGNATES RECOMMENDED LEVEL THAT DEVIATES FROM A STD. HYTYPE II PRINTER.
3. CHARACTERS SHOWN ON THIS DRAWING DO NOT REFLECT AESTHETICS OF INDIVIDUAL TYPE STYLES.
4. ELECTRICAL POSITION IS PRINTWHEEL SPOKE POSITION AS VIEWED FROM THE CHARACTER SIDE OF THE PRINTWHEEL.

Figure 5-9. 96-CHARACTER PRINT WHEEL - PLASTIC

ESC Y

5	91
3	

(MSB) b7				0	0	1	1	1	1						
b6				1	1	0	0	1	1						
b5				0	1	0	1	0	1						
b4	b3	b2	b1												
0	0	0	0	SP	0	86 10 4	@	75 21 4	P	10 86 4	,	41 18 1	p	67 29 4	
0	0	0	1	!	37 59 2	1	82 14 2	A	18 78 4	Q	52 44 4	a	59 37 3	q	72 24 4
0	0	1	0	"	33 63 2	2	83 13 3	B	8 88 4	R	28 68 4	b	68 28 3	r	55 41 2
0	0	1	1	#	92 4 4	3	84 12 3	C	36 60 3	S	14 82 4	c	62 34 3	s	51 45 3
0	1	0	0	\$	7 89 4	4	85 11 3	D	32 64 4	T	19 77 3	d	60 36 3	t	53 43 3
0	1	0	1	%	79 17 4	5	87 9 3	E	16 80 4	U	34 62 4	e	58 38 3	u	63 33 3
0	1	1	0	&	77 19 4	6	88 8 3	F	22 74 4	V	12 84 4	f	45 51 3	v	64 32 3
0	1	1	1	'	23 73 1	7	89 7 3	G	40 56 4	W	42 54 4	g	65 31 4	w	54 42 3
1	0	0	0	(76 20 2	8	90 6 4	H	26 70 4	X	50 46 4	h	61 35 3	x	70 26 3
1	0	0	1)	74 22 2	9	91 5 3	I	25 71 3	Y	44 52 4	i	47 49 2	y	66 30 3
1	0	1	0	*	15 81 3	:	29 67 2	J	21 75 3	Z	6 90 3	j	49 47 3	z	71 25 3
1	0	1	1	+	11 85 2	;	27 69 2	K	46 50 4			k	69 27 3	.	39 16 1
1	1	0	0	,	78 55 1	1/4	81 15 4	L	20 76 3			l	43 53 2		
1	1	0	1	-	35 61 1	=	9 87 2	M	38 58 4			m	48 48 4		
1	1	1	0	.	80 57 1	1/2	73 23 4	N	24 72 4			n	57 39 3		
1	1	1	1	/	31 65 2	?	17 79 2	O	30 66 4	—	13 83 1	o	56 40 3	DEL	

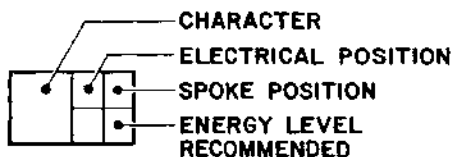

NOTES:

1. USE ENERGY SWITCH POSITION M FOR NORMAL USE, FOR MULTISTACK.
2. DESIGNATES RECOMMENDED LEVEL THAT DEVIATES FROM A STD HYTYPE II PRINTER.
3. CHARACTERS SHOWN ON THIS DRAWING DO NOT REFLECT AESTHETICS OF INDIVIDUAL TYPE STYLES.
4. ELECTRICAL POSITION IS PRINTWHEEL SPOKE POSITION AS VIEWED FROM THE CHARACTER SIDE OF THE PRINTWHEEL.

Figure 5-10. 88-CHARACTER PRINT WHEEL - METAL

ESC Y

Ç	5	91
	3	

(MSB) b7		0		0		1		1		1		1								
		b6		1		1		0		0		1								
b4	b3	b5		0		1		0		1		0								
		b2	b1	0		1		0		1		0								
0	0	0	0	SP		0	86	10	@	75	21	P	10	86	,	41	18	p	67	29
								4			4					1			4	
0	0	0	1	!	37 59	1	82	14	A	18	78	Q	52	44	a	59	37	q	72	24
					2			2			4					3			4	
0	0	1	0	"	33 63	2	83	13	B	8	88	R	28	68	b	68	28	r	55	41
					2			3			4					3			2	
0	0	1	1	#	92 4	3	84	12	C	36	60	S	14	82	c	62	34	s	51	45
					4			3			3					3			3	
0	1	0	0	\$	7 89	4	85	11	D	32	64	T	19	77	d	60	36	t	53	43
					4			3			4					3			3	
0	1	0	1	%	79 17	5	87	9	E	16	80	U	34	62	e	58	38	u	63	33
					4			3			4					3			3	
0	1	1	0	&	77 19	6	88	8	F	22	74	V	12	84	f	45	51	v	64	32
					4			3			4					3			3	
0	1	1	1	†	23 73	7	89	7	G	40	56	W	42	54	g	65	31	w	54	42
					1			3			4					4			3	
1	0	0	0	(76 20	8	90	6	H	26	70	X	50	46	h	61	35	x	70	26
					2			4			4					3			3	
1	0	0	1)	74 22	9	91	5	I	25	71	Y	44	52	i	47	49	y	66	30
					2			3			3					2			3	
1	0	1	0	*	15 81	:	29	67	J	21	75	Z	6	90	j	49	47	z	71	25
					3			2			3					3			3	
1	0	1	1	+	11 85	;	27	69	K	46	50	2	3	93	k	69	27	.	39	16
					2			2			4	3	4			3			1	
1	1	0	0	,	78 55	¼	81	15	L	20	76	£	4	92	l	43	53			
					1			4			3					2				
1	1	0	1	-	35 61	=	9	87	M	38	58	1	93	3	m	48	48			
					1			2			4	3	4			4				
1	1	1	0	.	80 57	1	73	23	N	24	72	3	94	2	n	57	39			
					1			4			4	4	4			3				
1	1	1	1	/	31 65	?	17	79	O	30	66	—	13	83	o	56	40	DEL		
					2			2			4					3				

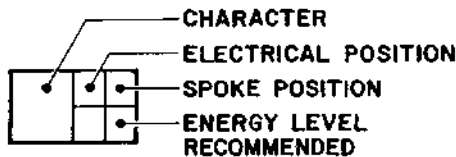

- NOTES:
1. USE ENERGY SWITCH POSITION M FOR NORMAL USE, FOR MULTISTACK.
 2. DESIGNATES RECOMMENDED LEVEL THAT DEVIATES FROM A STD HYTYPE II PRINTER.
 3. CHARACTERS SHOWN ON THIS DRAWING DO NOT REFLECT AESTHETICS OF INDIVIDUAL TYPE STYLES.
 4. ELECTRICAL POSITION IS PRINTWHEEL SPOKE POSITION AS VIEWED FROM THE CHARACTER SIDE OF THE PRINTWHEEL.

Figure 5-11. 92-CHARACTER PRINT WHEEL - METAL (Rank Xerox)

ESC Y		ESC Z	
ç	0 0	'	39 57
	5 3		5 1

(MSB) b7				0	0	1	1	1	1						
b6				1	1	0	0	1	1						
b5				0	1	0	1	0	1						
b4	b3	b2	b1												
0	0	0	0	sp		0	86 10 5 4	@	75 21 8 4	P	10 86 6 4	`	95 1 5 1	p	67 29 5 4
0	0	0	1	!	37 59 3 2	1	82 14 5 2	A	18 78 7 4	Q	52 44 7 4	a	59 37 5 3	q	72 24 5 4
0	0	1	0	"	33 63 4 2	2	83 13 5 3	B	8 88 6 4	R	28 68 7 4	b	68 28 5 3	r	55 41 4 2
0	0	1	1	#	92 4 6 4	3	84 12 5 3	C	36 60 7 3	S	14 82 5 4	c	62 34 5 3	s	51 45 4 3
0	1	0	0	\$	7 89 5 4	4	85 11 5 3	D	32 64 7 4	T	19 77 6 3	d	60 36 5 3	t	53 43 4 3
0	1	0	1	%	79 17 8 4	5	87 9 5 3	E	16 80 6 4	U	34 62 7 4	e	58 38 5 3	u	63 33 5 3
0	1	1	0	&	77 19 7 4	6	88 8 5 3	F	22 74 6 4	V	12 84 6 4	f	45 51 4 3	v	64 32 5 3
0	1	1	1	'	23 73 2 1	7	89 7 5 3	G	40 56 7 4	W	42 54 8 4	g	65 31 5 4	w	54 42 7 3
1	0	0	0	(76 20 3 2	8	90 6 5 4	H	26 70 7 4	X	50 46 7 4	h	61 35 5 3	x	70 26 5 3
1	0	0	1)	74 22 3 2	9	91 5 5 3	I	25 71 3 3	Y	44 52 7 4	i	47 49 3 2	y	66 30 5 3
1	0	1	0	x	15 81 5 3	:	29 67 3 2	J	21 75 5 3	Z	6 90 6 3	j	49 47 3 3	z	71 25 5 3
1	0	1	1	+	11 85 5 2	;	27 69 3 2	K	46 50 7 4	[81 15 3 2	k	69 27 5 3	{	4 92 3 2
1	1	0	0	,	78 18 3 1	<	41 55 5 2	L	20 76 6 3	\	3 93 5 2	l	43 53 3 2		73 23 3 2
1	1	0	1	-	35 61 4 1	=	9 87 5 2	M	38 58 8 4]	1 95 3 2	m	48 48 8 4	}	93 3 3 2
1	1	1	0	.	80 16 3 1	>	5 91 5 2	N	24 72 7 4	^	2 94 5 1	n	57 39 5 3	~	94 2 5 1
1	1	1	1	/	31 65 4 2	?	17 79 5 2	O	30 66 7 4	_	13 83 5 1	o	56 40 5 3	DEL	

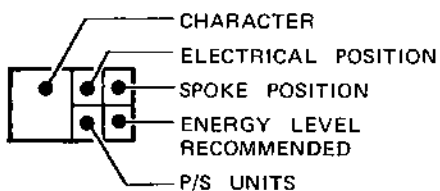

- NOTES:
1. USE ENERGY SWITCH POSITION M FOR NORMAL USE, FOR MULTISTACK.
 2. DESIGNATES RECOMMENDED LEVEL THAT DEVIATES FROM A STD HYTYPE II PRINTER.
 3. CHARACTERS SHOWN ON THIS DRAWING DO NOT REFLECT AESTHETICS OF INDIVIDUAL TYPE STYLES.
 4. ELECTRICAL POSITION IS PRINTWHEEL SPOKE POSITION AS VIEWED FROM THE CHARACTER SIDE OF THE PRINTWHEEL.

Figure 5-12. 96-CHARACTER PRINT WHEEL - METAL (Diablo)

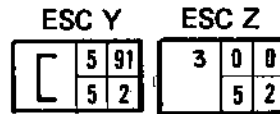

b4	b3	b2	b1	(MSB) b7											
				b7	b6	b5	b4								
0	0	0	0	SP	0	86 10 5 4	@	75 21 8 4	P	10 86 6 4	,	41 18 3 1	p	67 29 5 4	
0	0	0	1	!	37 59 3 2	1	82 14 5 2	A	18 78 7 4	Q	52 44 7 4	a	59 37 5 3	q	72 24 5 4
0	0	1	0	"	33 63 4 2	2	83 13 5 3	B	8 88 6 4	R	28 68 7 4	b	68 28 5 3	r	55 41 4 2
0	0	1	1	μ	92 4 6 3	3	84 12 5 3	C	36 60 7 3	S	14 82 5 4	c	62 34 5 3	s	51 45 4 3
0	1	0	0	\$	7 89 5 4	4	85 11 5 3	D	32 64 7 4	T	19 77 6 3	d	60 36 5 3	t	53 43 4 3
0	1	0	1	%	79 17 8 4	5	87 9 5 3	E	16 80 6 4	U	34 62 7 4	e	58 38 5 3	u	63 33 5 3
0	1	1	0	&	77 19 7 4	6	88 8 5 3	F	22 74 6 4	V	12 84 6 4	f	45 51 4 3	v	64 32 5 3
0	1	1	1	'	23 73 2 1	7	89 7 5 3	G	40 56 7 4	W	42 54 8 4	g	65 31 5 4	w	54 42 7 3
1	0	0	0	(76 20 3 2	8	90 6 5 4	H	26 70 7 4	X	50 46 7 4	h	61 35 5 3	x	70 26 5 3
1	0	0	1)	74 22 3 2	9	91 5 5 3	I	25 71 3 3	Y	44 52 7 4	i	47 49 3 2	y	66 30 5 3
1	0	1	0	*	15 81 5 3	:	29 67 3 2	J	21 75 5 3	Z	6 90 6 3	j	49 47 3 3	z	71 25 5 3
1	0	1	1	+	11 85 5 2	;	27 69 3 2	K	46 50 7 4]	3 93 6 4	k	69 27 5 3	.	39 16 3 1
1	1	0	0	,	78 55 3 1	¼	81 15 6 4	L	20 76 6 3	£	4 92 5 4	l	43 53 3 2	<	1 95 6 2
1	1	0	1	-	35 61 4 1	=	9 87 5 2	M	38 58 8 4	°	93 3 5 1	m	48 48 8 4	2	2 94 5 2
1	1	1	0	.	80 57 3 1	½	73 23 6 4	N	24 72 7 4	¾	94 2 6 4	n	57 39 5 3	>	95 1 6 2
1	1	1	1	/	31 65 4 2	?	17 79 5 2	O	30 66 7 4	—	13 83 5 1	o	56 40 5 3	DEL	

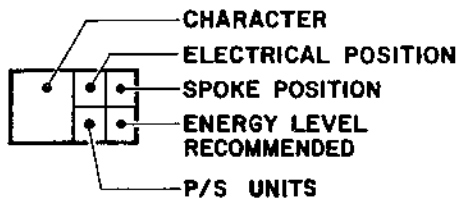

NOTES:

1. USE ENERGY SWITCH POSITION M FOR NORMAL USE, FOR MULTISTACK.
2. DESIGNATES RECOMMENDED LEVEL THAT DEVIATES FROM A STD HYTYPE II PRINTER.
3. CHARACTERS SHOWN ON THIS DRAWING DO NOT REFLECT AESTHETICS OF INDIVIDUAL TYPE STYLES.
4. ELECTRICAL POSITION IS PRINTWHEEL SPOKE POSITION AS VIEWED FROM THE CHARACTER SIDE OF THE PRINTWHEEL.

Figure 5-13. 96-CHARACTER PRINT WHEEL - METAL (Rank Xerox)

5.4 DECIMAL VALUE TABLES

The Decimal Value Tables are used to determine the third character (n) to use in 3-character sequences for setting format factors and for absolute tabbing. The associated procedures are covered in the following subsections.

- Setting HMI is covered in subsection 4.9.4;
- Setting VMI is covered in subsection 4.9.5;
- Lines Per Page is covered in subsection 4.9.6;
- Absolute Horizontal Tab is covered in subsection 4.13.2;
- Absolute Vertical Tab is covered in subsection 4.13.4

The following list summarizes the corresponding ESC code sequences:

ESC	US	(n)	Set HMI
ESC	RS	(n)	Set VMI
ESC	FF	(n)	Lines Per Page
ESC	HT	(n)	Absolute Horizontal Tab
ESC	VT	(n)	Absolute Vertical Tab

Table 5-2 gives a listing of decimal values for ASCII characters.

Table 5-2
DECIMAL VALUES OF ASCII CHARACTERS

		Units									
		0	1	2	3	4	5	6	7	8	9
	0		SOH	STX	ETX	EOT	ENQ	ACK	BEL	BS	HT
	10	LF	VT	FF	CR	SO	SI	DLE	DC1	DC2	DC3
	20	DC4	NAK	SYN	ETB	CAN	EM	SUB	ESC	FS	GS
T	30	RS	US	SP	!	"	#	\$	%	&	'
	40	()	*	+	,	-	.	/	0	1
e	50	2	3	4	5	6	7	8	9	:	;
	60	<	=	>	?	@	A	B	C	D	E
n	70	F	G	H	I	J	K	L	M	N	O
	80	P	Q	R	S	T	U	V	W	X	Y
s	90	Z	[\]	^	_	`	a	b	c
	100	d	e	f	g	h	i	j	k	l	m
	110	n	o	p	q	r	s	t	u	v	w
	120	x	y	z	{		}	~			

Table 5-3
ASCII VALUES FOR ESC SEQUENCES
Set HMI
Set VMI

HMI/VMI	ASCII Character	HMI/VMI	ASCII Character	HMI/VMI	ASCII Character	HMI/VMI	ASCII Character
0	CTRL A (SOH)						
1	CTRL B (STX)	26	CTRL [ESC	51	4	76	M f
2	CTRL C (ETX)	27	CTRL \ (FS)	52	5	77	N g
3	CTRL D (EOT)	*28	CTRL] (GS)	53	6	78	O h
4	CTRL E (ENQ)	**29	CTRL ^ (RS)	54	7	79	P i
5	CTRL F (ACK)	30	CTRL _ (US)	55	8	80	Q j
6	CTRL G (BEL)	31	SPACE	56	9	81	R k
7	CTRL H BACKSPACE	32	!	57	:	82	S l
8	CTRL I TAB	33	"	58	;	83	T m
9	CTRL J LINEFEED	34	#	59	<	84	U n
10	CTRL K (VT)	35	\$	60	=	85	V o
11	CTRL L (FF)	36	%	61	>	86	W p
12	CTRL M RETURN	37	&	62	?	87	X q
13	CTRL N (SO)	38	'	63	@	88	Y r
14	CTRL O (SI)	39	(64	A	89	Z s
15	CTRL P (DLE)	40)	65	B	90	[t
16	CTRL Q (DC1)	41	*	66	C	91	\ u
17	CTRL R (DC2)	42	+	67	D	92] v
18	CTRL S (DC3)	43	,	68	E	93	^ w
19	CTRL T (DC4)	44	-	69	F	94	_ x
20	CTRL U (NAK)	45	.	70	G	95	` y
21	CTRL V (SYN)	46	/	71	H	96	a z
22	CTRL W (ETB)	47	0	72	I	97	b {
23	CTRL X (CAN)	48	1	73	J	98	c
24	CTRL Y (EM)	49	2	74	K	99	d }
25	CTRL Z (SUB)	50	3	75	L	100	e ~

*Diablo Typewriter Paired keyboard uses ` (accent grave)

**Diablo Typewriter Paired keyboard uses = (equals symbol)

Table 5-4
 ASCII VALUES FOR ESC SEQUENCES
 Set Lines/Page
 Set Absolute Horizontal Tab
 Set Absolute Vertical Tab

Lines or Position	ASCII Character	Lines or Position	ASCII Character	Lines or Position	ASCII Character	Lines or Position	ASCII Character	Lines or Position	ASCII Character
1	CTRL A (SOH)	26	CTRL Z (SUB)	51	3	76	L	101	e
2	CTRL B (STX)	27	CTRL [ESC	52	4	77	M	102	f
3	CTRL C (ETX)	28	CTRL \ (FS)	53	5	78	N	103	g
4	CTRL D (EOT)	*29	CTRL] (GS)	54	6	79	O	104	h
5	CTRL E (ENQ)	**30	CTRL ^ (RS)	55	7	80	P	105	i
6	CTRL F (ACK)	31	CTRL _ (US)	56	8	81	Q	106	j
7	CTRL G (BEL)	32	SPACE	57	9	82	R	107	k
8	CTRL H BACKSPACE	33	!	58	:	83	S	108	l
9	CTRL I TAB	34	"	59	;	84	T	109	m
10	CTRL J LINEFEED	35	#	60	<	85	U	110	n
11	CTRL K (VT)	36	\$	61	=	86	V	111	o
12	CTRL L (FF)	37	%	62	>	87	W	112	p
13	CTRL M RETURN	38	&	63	?	88	X	113	q
14	CTRL N (SO)	39	'	64	@	89	Y	114	r
15	CTRL O (SI)	40	(65	A	90	Z	115	s
16	CTRL P (DLE)	41)	66	B	91	[116	t
17	CTRL Q (DC1)	42	*	67	C	92	\	117	u
18	CTRL R (DC2)	43	+	68	D	93]	118	v
19	CTRL S (DC3)	44	,	69	E	94	^	119	w
20	CTRL T (DC4)	45	-	70	F	95	_	120	x
21	CTRL U (NAK)	46	.	71	G	96	`	121	y
22	CTRL V (SYN)	47	/	72	H	97	a	122	z
23	CTRL W (ETB)	48	0	73	I	98	b	123	{
24	CTRL X (CAN)	49	1	74	J	99	c	124	
25	CTRL Y (EM)	50	2	75	K	100	d	125	}
								126	~

*Diablo Typewriter Paired keyboard uses ` (accent grave)
 **Diablo Typewriter Paired keyboard uses = (equals symbol)

Table 5-5
CHARACTER PROPORTIONAL SPACE UNITS - METAL PRINT WHEELS

PW POSITION	CHARACTER	PS UNIT	PW POSITION	CHARACTER	PS UNIT	PW POSITION	CHARACTER	PS UNIT	PW POSITION	CHARACTER	PS UNIT
1	()	(3)	25	l	3	49	j	3	73	½	6
2	(^)	(5)	26	H	7	50	X	7	74)	3
3	¾ (\)	6 (5)	27	;	3	51	s	4	75	@	8
4	£ ({)	5 (3)	28	R	7	52	Q	7	76	(3
5	¢ ()	5	29	:	3	53	t	4	77	&	7
6	Z	6	30	O	7	54	w	7	78	,	3
7	\$	5	31	/	4	55	r	4	79	%	8
8	B	6	32	D	7	56	o	5	80	.	3
9	=	5	33	"	4	57	n	5	81	¼	6
10	P	6	34	U	7	58	e	5	82	1	5
11	+	5	35	-	4	59	a	5	83	2	5
12	V	6	36	C	7	60	d	5	84	3	5
13	_	5	37	f	3	61	h	5	85	4	5
14	S	5	38	M	8	62	c	5	86	0	5
15	*	5	39	.	3	63	u	5	87	5	5
16	E	6	40	G	7	64	v	5	88	6	5
17	?	5	41	,	3	65	g	5	89	7	5
18	A	7	42	W	8	66	y	5	90	8	5
19	T	6	43	l	3	67	p	5	91	9	5
20	L	6	44	Y	7	68	b	5	92	#	6
21	J	5	45	f	4	69	k	5	93	⅓ ()	6 (3)
22	F	6	46	K	7	70	x	5	94	¼ (~)	6 (5)
23	'	2	47	i	3	71	z	5	95	(^)	(5)
24	N	7	48	m	8	72	q	5		0 (HOME)	(†) (5)

NOTES:

- Units = 1/120 inch (.212mm) carriage movement.
- Characters and PS unit values listed in this table represent 88-character "Titan 10", 92-character "Titan 10" (UK), and 96-character "Titan 10" print wheels. Parentheses () are used where characters and/or PS units of the 96-character wheel differ from those of the 88 and 92-character wheels. PW POSITION utilization is 5 thru 92 for 88-character wheels, 3 thru 94 for 92-character wheels, and 1 thru 0 for 96-character wheels. For similar data on other fonts refer to the Diablo Print Wheel Data Book, Publication No. 90044-XX.

Table 5-6
 CHARACTER PROPORTIONAL SPACE UNITS - PLASTIC PRINT WHEELS

PW POSITION	CHARACTER	PS UNIT	PW POSITION	CHARACTER	PS UNIT	PW POSITION	CHARACTER	PS UNIT	PW POSITION	CHARACTER	PS UNIT
1	␣	4	25	Y	6	49	{	3	73	v	5
2	␣	5	26	P	5	50	>	5	74	g	5
3	,	3	27	Q	6	51	□	4	75	x	5
4	W	7	28	K	6	52	~	5	76	d	5
5	.	3	29	J	4	53	□	4	77	l	3
6	M	7	30	V	6	54	.	2	78	b	5
7	Z	5	31	;	3	55	-	6	79	c	5
8	B	5	32	X	6	56	\'	5	80	o	5
9	F	5	33	1	5	57	<	5	81	r	4
10	C	6	34	2	5	58	}	3	82	n	5
11	A	6	35	3	5	59	!	2	83	e	5
12	:	3	36	4	5	60	(3	84	a	5
13	R	6	37	0	5	61	*	4	85	i	3
14	S	5	38	5	5	62	@	7	86	t	4
15	E	5	39	6	5	63	\	4	87	h	5
16	T	5	40	7	5	64	^	5	88	s	4
17	H	6	41	8	5	65	?	5	89	f	4
18	O	6	42	9	5	66	/	4	90	p	5
19	N	6	43	-	5	67)	3	91	u	5
20	I	3	44	\$	5	68		3	92	q	5
21	L	5	45	+	5	69	&	6	93	k	5
22	D	6	46	#	5	70	”	4	94	y	5
23	U	6	47	%	5	71	m	7	95	z	5
24	G	6	48	=	5	72	j	2	0	w	7

NOTES:

1. Units = 1/120 inch (.212mm) carriage movement.
2. Characters and PS unit values listed in this table represent a 96 character plastic print wheel.

Table 5-7
 PRINT WHEEL PROGRAM MODE - CHARACTERS FOR HAMMER ENERGY AND RIBBON ADVANCE

HAMMER ENERGY	RIBBON ADVANCE														
	1	2	3	4	5	6	7	8	9	10	11	12	13	14	15
1	DC1	DC2	DC3	DC4	NAK	SYN	ETB	CAN	EM	SUB	ESC	FS	GS	RS	US
2	!	"	#	\$	%	&	'	()	*	+	,	-	.	/
3	1	2	3	4	5	6	7	8	9	:	;	<	=	>	?
4	A	B	C	D	E	F	G	H	I	J	K	L	M	N	O
	Q	R	S	T	U	V	W	X	Y	Z	[/]	^	-
	a	b	c	d	e	f	g	h	i	j	k	l	m	n	o
	q	r	s	t	u	v	w	x	y	z	{	:	}	~	DEL

6

11

6

11

APPENDIX A

Figure A-1 indicates the order of priority for each means of language selection in the RO and the KSR Model 630. In all cases, ESC SYN (n) has the highest priority, and the HPRO5 circuit board switches 6, 7 and 8 have the lowest priority. When the nonvolatile (NV) RAM is present, the stored language select parameter dictates language selection. In units with NV RAM, language selection can be changed only by the sequence ESC SYN (n).

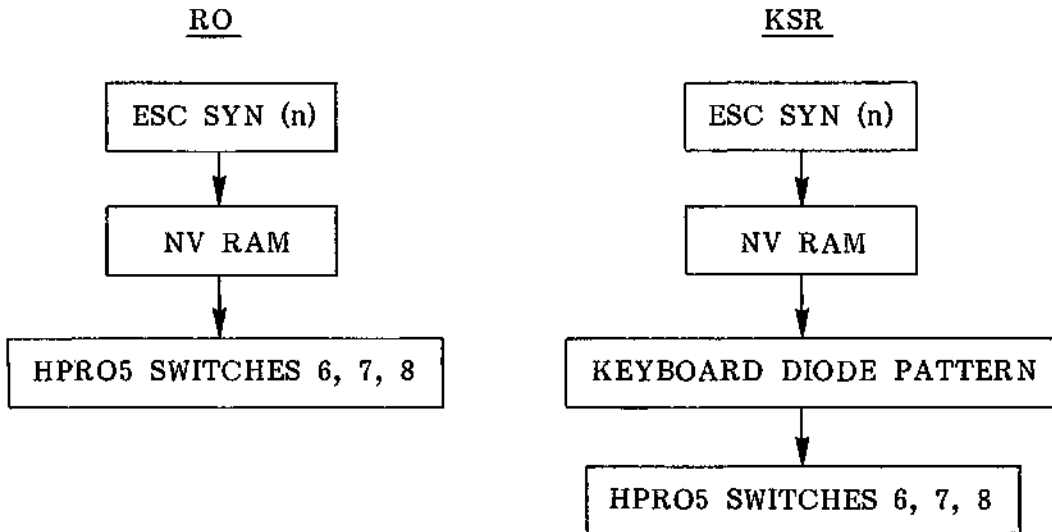
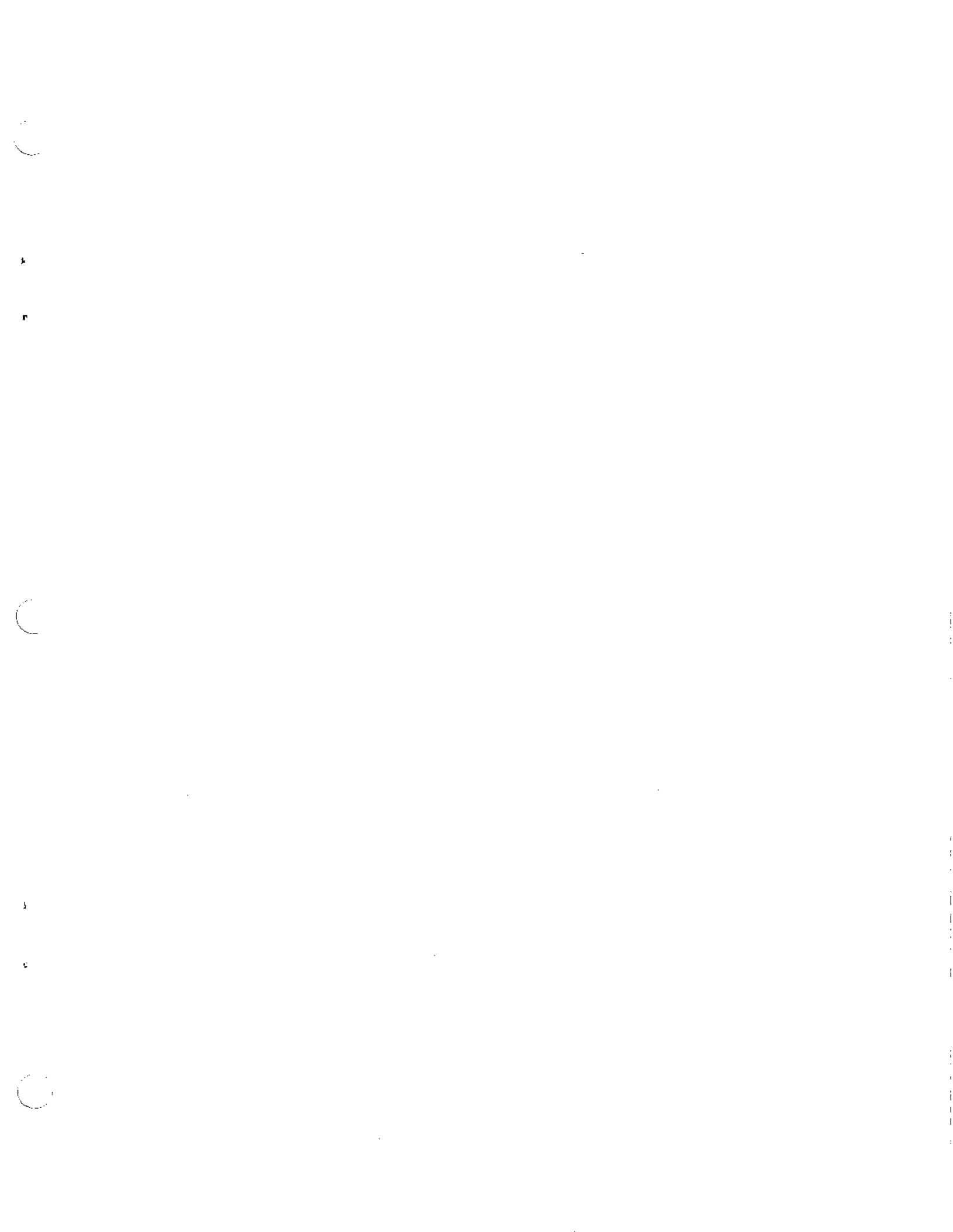

Figure A-1. LANGUAGE SELECT PRIORITY CHART



XEROX

Diablo Systems Incorporated

24500 Industrial Boulevard
Hayward, California 94545

A Xerox Company