



TECHNICAL MANUAL
TAPE PUNCH MECHANISM
MODELS: RPM612XBAA
RPM612XBAB

Peripheral
Products

Ex-Cell-O Corporation

TECHNICAL MANUAL
TAPE PUNCH MECHANISM
MODELS: RPM612XBAA
RPM612XBAB

IMPORTANT INFORMATION

Changes to the equipment which are made between manual printings are listed in an addendum at the rear of the manual. As a convenience, a list of change pages is given as the last page in the manual. It is recommended that each of these pages be marked "Refer to Addendum" so that these changes can be identified.

EX-CELL-O CORPORATION

REMEX

1733 Alton St. • P.O. Box C-19533 • Irvine, CA 92713

Copyright© 1976 by REMEX, A Unit of Ex-Cell-O Corporation. Printed in the United States of America. All rights reserved. This book or parts thereof may not be reproduced in any form without permission of the publishers.

WARRANTY

The following section is part of the Standard Terms and Conditions and covers only the Warranty. The reader should refer to the complete Standard Terms and Conditions for the entire sales agreement.

The Seller warrants to the original Buyer only, that the Product, except as to software and firmware, is free from defects in workmanship and material under normal use and service. The Seller's obligation under this warranty shall be limited to furnishing a replacement for, or at the Seller's option repairing any Product or any part or parts thereof, which prove defective within 90 days* from the date of shipment by the Seller, provided such Product or such part or parts are returned to the Seller transportation prepaid.

The Seller warrants, for a period of thirty (30) days from the date of shipment by the Seller to the original Buyer only, that the software and firmware Products are free from defects in workmanship and material. Seller's obligation under this warranty shall be limited to correcting any of said defects or replacing the software or firmware. Said warranty shall be void and of no effect whatsoever in the event that changes or additions have been made to the software or firmware (or in the event that the software or firmware product has been adapted by the Buyer) to serve a function not within the system specifications of the Seller.



All replacement Products or parts thereof furnished under this warranty will be invoiced in the usual manner and adjustments will be made after the Product or part thereof claimed to be defective has been returned to, and inspected at, the Seller's plant. Replacements shall be furnished under this warranty F.O.B. Buyer's plant, and the Seller shall not be responsible for installation costs. (For all international transactions, replacement shall be furnished F.O.B. Port of Entry and Buyer is responsible for all customs and brokerage fees.) The Buyer shall be liable for all freight inspection and handling costs if such Product or such part or parts do not prove to be defective. In no event will any claim for labor in removing or replacing a defective Product or part for incidental or consequential damages be allowed. No warranty is made as to any Product or part which has not been installed, operated, or maintained in accordance with Seller's instructions or the instructions contained in its operations or maintenance manuals, when furnished by the Seller, or which has been subject to misuse, abuse, accident, or alteration or to improper or negligent use, maintenance, storage, transportation or handling.

This warranty is in lieu of all other warranties expresses or implied, including any warranty of merchantability or fitness for a particular purpose, and the Seller neither assumes, nor authorizes any person or firm to assume for it, any other or further obligation or liability in connection with the sales, installation or use of any product.

UNDER NO CIRCUMSTANCES SHALL SELLER OR ANY AFFILIATE OF SELLER HAVE ANY LIABILITY WHATSOEVER FOR LOSS OF USE OR FOR ANY INDIRECT, INCIDENTAL OR CONSEQUENTIAL DAMAGES.

*All paper tape products are covered under this warranty for a period of one year, excepting punch mechanisms, lamps and fuses which are warranted for a period of 90 days. Flexible disk drives are warranted for a period of 180 days.

FOR YOUR SAFETY

Before undertaking any maintenance procedure, whether it be a specific troubleshooting or maintenance procedure described herein or an exploratory procedure aimed at determining whether there has been a malfunction, read the applicable section of this manual and note carefully the  and  contained therein.

The equipment described in this manual contains voltages hazardous to human life and safety and may contain mechanical components capable of inflicting personal injury. The cautionary and warning notes are included in this manual to alert operator and maintenance personnel to the electrical and mechanical hazards and thus prevent personal injury and damage to equipment.

TABLE OF CONTENTS

Section	Title	Page
I	GENERAL DESCRIPTION	1-1
1.1	EQUIPMENT DESCRIPTION	1-1
1.2	SPECIFICATIONS	1-1
1.3	MODEL NUMBER DESIGNATION	1-1
1.4	EQUIPMENT SUPPLIED	1-1
1.5	TAPE CHANNEL NUMBERING	1-6
1.6	TAPE PREPARATION SPECIFICATIONS	1-6
II	INSTALLATION AND INTERFACE	2-1
2.1	UNPACKING	2-1
2.2	MOUNTING	2-1
2.3	INITIAL ADJUSTMENTS	2-1
2.4	INTERFACE	2-1
III	OPERATION	3-1
3.1	STEP MOTOR DRIVE	3-1
3.2	PUNCH SOLENOID DRIVE	3-1
3.3	SYNCHRONIZATION OF TAPE FEED AND PUNCHING	3-1
3.4	TAPE RECOMMENDATIONS	3-2
IV	THEORY OF OPERATION	4-1
4.1	GENERAL	4-1
4.2	TAPE PATHWAY	4-1
4.3	TAPE DRIVE	4-1
4.4	TAPE PUNCHING	4-1
V	MAINTENANCE	5-1
5.1	GENERAL	5-1
5.2	REMEX OVERHAUL/EXCHANGE PROGRAM (OUT OF WARRANTY PUNCHES ONLY)	5-1
5.3	PREVENTIVE MAINTENANCE	5-2
5.3.1	100 ROLL SERVICE (50 FOR CERTAIN TYPES OF TAPE)	5-2

TABLE OF CONTENTS
(CONTINUED)

Section	Title	Page
5.3.1.1	Lubrication	5-2
5.3.1.2	Punch Cleaning	5-5
5.3.1.3	Registration	5-6
5.3.2	700 ROLL SERVICE	5-6
5.3.2.1	100 Roll Service	5-6
5.3.2.2	Wear Checks	5-6
5.3.2.3	Bearing Checks	5-6
5.4	REGISTRATION CHECK AND ALIGNMENT	5-7
5.5	PUNCH PIN DEPTH ADJUSTMENT	5-10
5.6	EDGE GUIDE ASSEMBLY ADJUSTMENT	5-12
5.7	TROUBLE SHOOTING	
VI	PARTS REPLACEMENT	6-1
6.1	GENERAL	6-1
6.2	TAPE GUIDE/EDGE GUIDE ASSEMBLY REPLACEMENT	6-1
6.3	TAPE DRIVE ASSEMBLY REPLACEMENT	6-3
6.4	STEP MOTOR ASSEMBLY OR SPROCKET REPLACEMENT	6-3
6.5	SOLENOID ASSEMBLY REPLACEMENT	6-4
6.6	PUNCH AND PIN BLOCK ASSEMBLY REPLACEMENT	6-5
6.7	PIN DRIVER REPLACEMENT	6-8
VII	PARTS LIST	7-1
7.1	GENERAL	7-1
7.2	KIT OF PARTS	7-1
VIII	SCHEMATIC	8-1
8.1	GENERAL	8-1

LIST OF ILLUSTRATIONS

Figure	Title	Page
1-1	REMEX Tape Perforator, Model RPM612XBAA	1-2
1-2	REMEX Tape Perforator, Model RPM612XBAB (Photo not available at time of printing)	1-2
1-3	Installation Drawing RAB612XBAB	1-4
1-4	Model Number Designations	1-5
1-5	Tape Configurations Available	1-7/1-8
2-1	Suggested Drive Circuits	2-2
3-1	RPM612X Punch Mechanism Timing Diagrams	3-3/3-4
5-1	Punch Head Greasing Instructions	5-4
5-2	Die Post Hole Cleaning Procedure	5-5
5-3	Sprocket Alignment Using Tape Gauge	5-9
5-4	Tape Drive Assembly Alignment	5-11
5-5	Fixed Tape Guide Alignment	5-11
5-6	Setting Punch Pin Depth	5-13
6-1	Tape Guide and Edge Guide Assembly Alignment	6-2
6-2	Solenoid Location for each Track	6-5
6-3	Punch Pin Alignment and Insertion into Pin Driver	6-7
6-4	Installation of Punch and Pin Block Assembly	6-7
6-5	Adjustment of Support Bar and Support Bracket	6-9/6-10
7-1	Exploded Drawing of the RPM612XBAX	7-5/7-6
8-1	Schematic, RPM612XBAB	8-2

LIST OF TABLES

Table	Title	Page
1-1	Specifications for Tape Punch Mechanism RPM612X	1-3
1-2	Equipment Supplied, RPM612XBAB	1-3
2-1	Suggested Drive Circuits	2-2
3-1	Acceptable Tapes	3-2
5-1	Special Maintenance Equipment Required	5-2
5-2	Preventive Maintenance Log	5-3
5-3	Troubleshooting Chart	5-14
7-1	Recommended Spare Parts	7-1
7-2	Parts List RPM612XBAX	7-2

SECTION I

GENERAL DESCRIPTION

1.1 EQUIPMENT DESCRIPTION

The REMEX Tape Punch Mechanism, Model RPM612XBAX is a small, rugged device designed to perforate standard 8 track or 6 track typesetter tapes of paper or mylar at speeds up to 120 cps.

This manual is designed to cover both the RPM612XBAA, Figure 1-1, (perforator designed into a system) or RPM612XBAB (perforator sold by itself) Figure 1-2. The basic difference is that the RPM612XBAB contains a fuse card on which the solenoid fuses are mounted. The output connector also differs between the two units.

The unit employs a stepper motor driver tape feed that assures control of longitudinal registration without the need for periodic adjustment. The mechanism basically consists of three parts: (1) the tape pathway with a reference edge against which the tape runs, (2) the stepper motor driven feed mechanism, and (3) the punching mechanism consisting of punch solenoids, punch pin drive linkage and punch head. Power and external control and timing are provided by the user.

1.2 SPECIFICATIONS

Table 1-1 lists the specifications for the RPM612XBAX.

1.3 MODEL NUMBER DESIGNATION

Figure 1-4 explains the REMEX model numbering configuration for the RPM612XBAX. The basic perforator mechanism is identified as an RPM612XBAX with the "X" in the seventh and tenth digits used to provide particular information concerning the perforator. The various designators available (as shown in Figure 1-3) for the seventh digit are as follows: 1 = 8 Track Steel Block, 2 = 8 Track Carbide Block, 3 = 6 Track Steel Block with advanced feed hole and 4 = 6 Track Carbide Block with advanced feed hole. In the tenth digit either an A (perforator designed into a system) or B (perforator sold by itself) can be inserted.

1.4 EQUIPMENT SUPPLIED

Table 1-2 lists the equipment supplied with the RPM612XBAB Punch Mechanism. Equipment supplied with the RPM612XBAA is contained in the manual for the system into which it is designed.

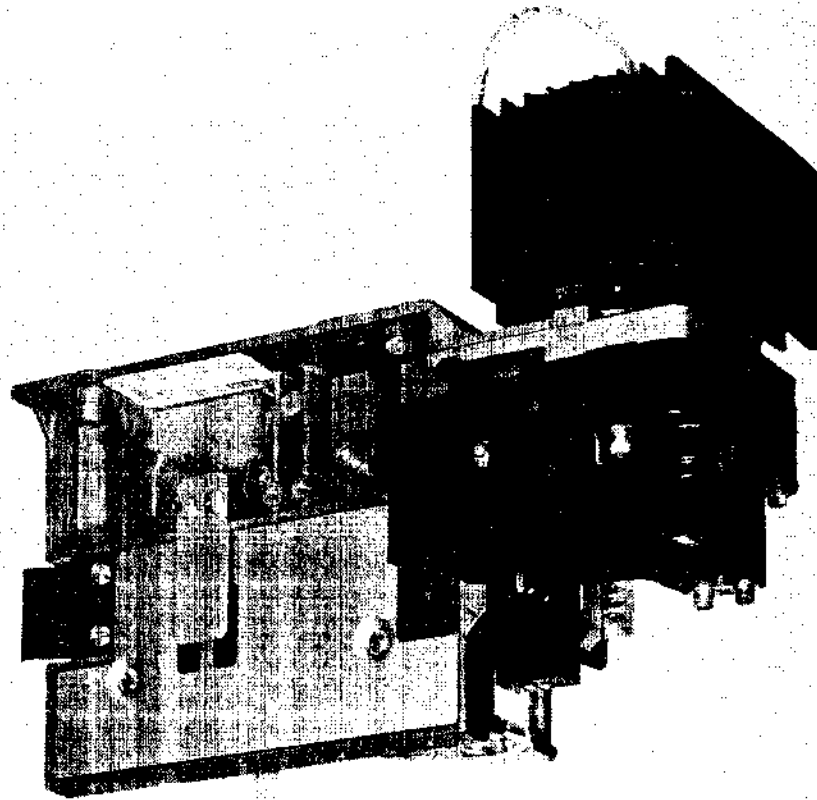

Figure 1-1. REMEX Tape Perforator, Model RPM612XBAA.

PHOTO NOT AVAILABLE AT TIME OF PRINTING

Figure 1-2. REMEX Tape Perforator, Model RPM612XBAB.

Table 1-1. Specifications for Tape Punch Mechanism RPM612X

Characteristics	Specifications
Tape Material and Dimensions	Perforates standard 8 and 5 or 6 channel typesetter paper, paper mylar, or aluminum mylar with a thickness between 0.0026 and 0.0043 inch. Tape can be in roll form or fanfolded.
Punching Speed	Up to 120 characters/second.
Timing	Timing diagrams are shown in Figure 3-1.
Supply Tension	Static supply tension 2-3 oz. Motor driven supply system recommended.
Motor Drive Data	Input Current Pulse: 4 amps max. 2 amps average. See part 5 and 6 of Figure 3-1. D.C. Resistance: 20 ohm/phase. Inductance/phase: 25 mH Input Voltage and Damping: See part 4 of Figure 3-1. Energizing Sequence: $\phi 1, \phi 3, \phi 2$ - Forward Motion $\phi 1, \phi 2, \phi 3$ - Backspacing.
Solenoid Data	Voltage: Between 23 and 35 Vdc, See Figure 1 of Figure 3-1. Peak Current: 3 amps. Nominal D.C. Resistance: 2.8 ohms \pm 10%. Inductance: 15 mH, de-energized; 40 mH energized.
Life Expectancy	Minimum life expectancy is 8.4×10^7 characters for Models 6121 and 6123 when used with oiled or unoled paper tape. Models 6122 and 6124 use tungsten carbide punch block and exhibit approximately 3 times the life of the 6121 and 6123 models when using paper tape.
Environmental	Temperature Range: $+5^{\circ}\text{C}$ to $+55^{\circ}\text{C}$ free air. Relative Humidity: 10% to 90%, without condensation. Blower must be provided to maintain motor heat sink temperature at 60°C max. during continuous 120 cps operation at 25°C ambient.
Weight	4 lbs.
Dimensions	See Figure 1-3 for RPM612XBAB. Since model RPM612XBAA comes already installed, no installation drawing is given for this model.

Table 1-2. Equipment Supplied, RPM612XBAB

Description	REMEX Part No.	Quantity
Connector, Molex 03-06-1152	706510-233	1
Contacts, Molex 02-06-1103	706530-156	15
Fuse, 2A, GMW-2	705725-110	3
Grease, 1 oz. tube, Rheolube 723-MS	716004-207	1
Instruction Sheet, Greasing	112210	1
Syringe, 30cc, Semco	716056-108	1

SYM	ECO	EFFECT.	REVISIONS	BY	DATE	APPROV.
A	-	6-6-75	RELEASED	S.E.O.	6-6-75	S.E.O.
B	16742	6-24-77	DIM. .53 WAS .30	S.E.O.	6-24-77	S.E.O.

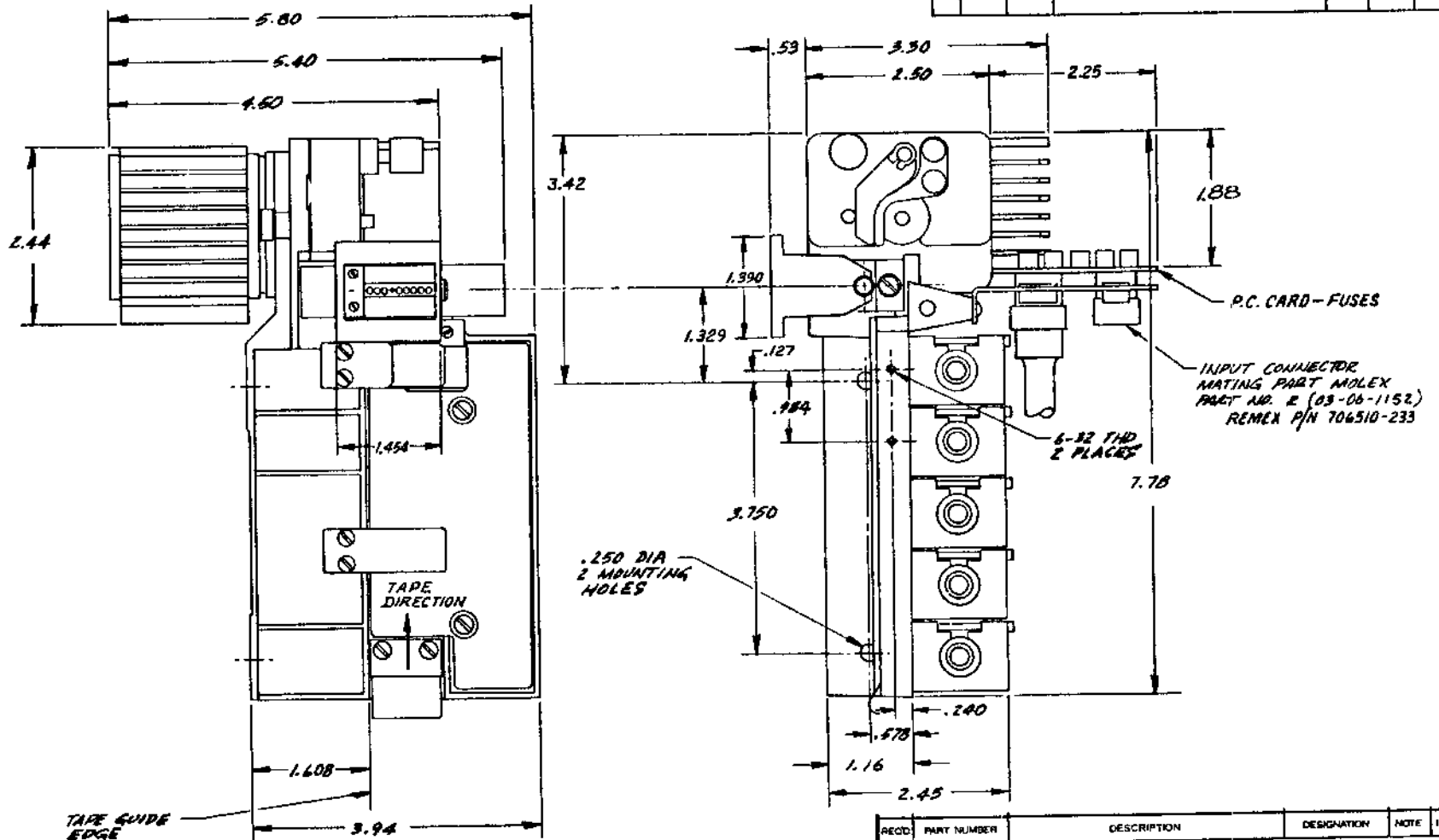

NOTICE
 THIS DRAWING IS THE PROPERTY OF REMEX, A UNIT OF EX-CELL-O CORPORATION AND SHOULD BE KEPT AS A CONFIDENTIAL PROPRIETARY DESIGN IN WHICH REMEX RETAINS ALL PATENT AND OTHER RIGHTS INCLUDING EXCLUSIVE RIGHT OF USE, MANUFACTURE AND SALE. IT IS SUBMITTED UNDER A CONFIDENTIAL RELATIONSHIP FOR A SPECIFIC PURPOSE, AND THE BUYER'S AGREE, BY ACCEPTING THIS DRAWING, NOT TO SUPPLY OR DISCLOSE ANY INFORMATION REGARDING IT TO ANY UNAUTHORIZED PERSON.

REQD.	PART NUMBER	DESCRIPTION	DESIGNATION	NOTE	ITEM
LIST OF MATERIALS					
UNLESS OTHERWISE SPECIFIED DIMENSIONS ARE IN INCHES:		DR. S.E.O. DATE 4-25-75 TOLERANCES: FRACTIONS DECIMALS ANGLES $\pm 1/32$ $\pm .005$ $\pm 1/2$ $\times \times \times \pm .01$ SURFACE ROUGHNESS <input checked="" type="checkbox"/> BREAK SHARP EDGES .000 MAX. MATERIAL _____ FINISH _____			
TITLE INSTALLATION DWG. RPM 6XXXBAB/ PUNCH MECHANISM		1755 ALTON STREET SANTA ANA, CALIF 92705 REMEX A UNIT OF EX-CELL-O CORPORATION			
APPROVAL	CODE IDENT NO	SIZE	DWG NO	A/E/C	
OUTSIDE APP:	C		112591	B	
USED ON	NEXT ASSY:	SCALE	DO NOT SCALE DRAWING	SHEET 1 OF 1	

112591 B

Figure 1-3. Installation Drawing RAB612XBAB.

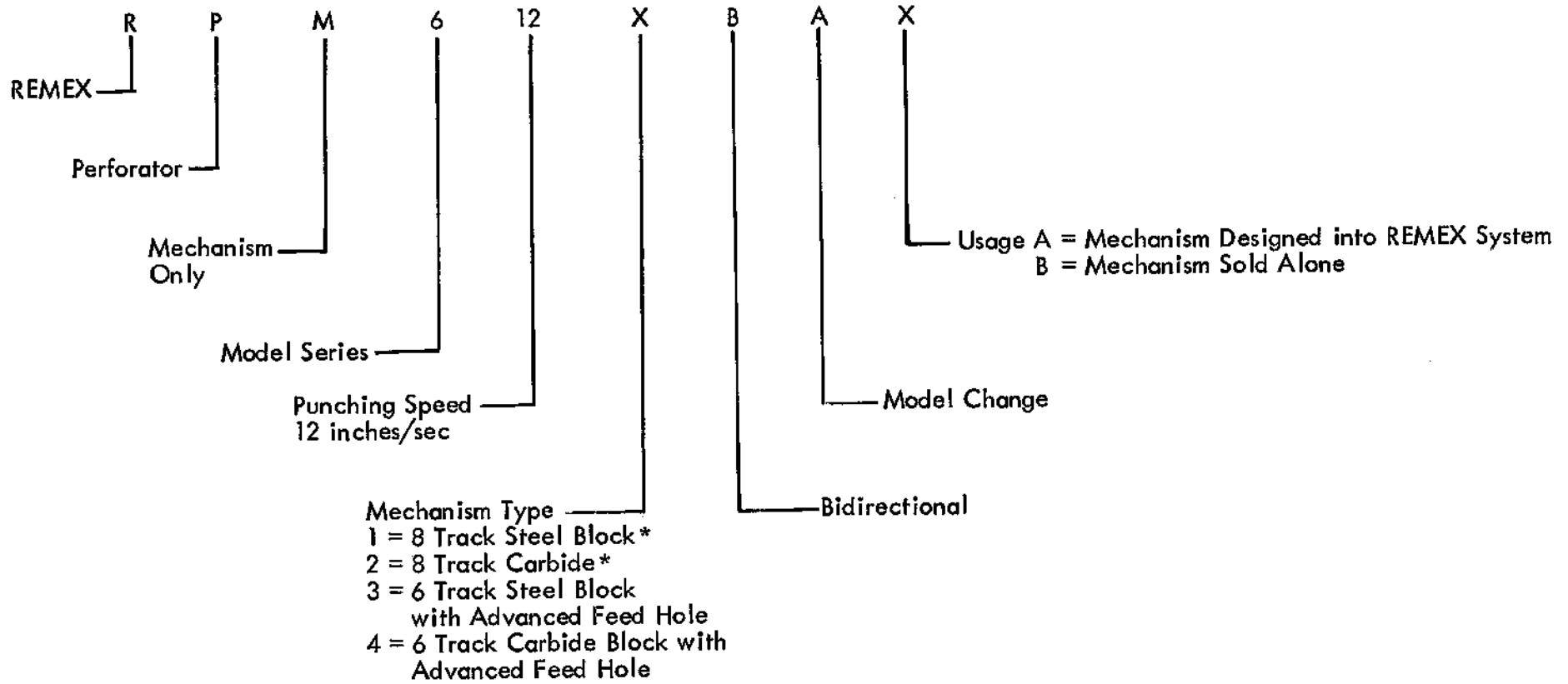

*5 Track tape may also be punched on this model.

Figure 1-4. Model Number Designation.

1.5 TAPE CHANNEL NUMBERING

The RPM612XBAX is available in either standard 8, 5 or 6 channel typesetter configurations. Figure 1-5 illustrates the configurations of tape along with the important dimensions.

1.6 TAPE PREPARATION SPECIFICATIONS

Tape specifications as given in Figure 1-5 are based on the American National Standards Institute Standard X3.18-1967 (ANSI; formerly United States of America Standards Institute). A tape gauge is available from REMEX (part number 110597) so that longitudinal and perpendicular transverse spacings can be checked. To use the gauge, place the feed hole of one end of a 5-inch span (50 characters) at the single cross hair and swing the other end of the 5-inch span in an arc until one of the cross hairs is centered in the feed hole. Read the measurement adjacent to that cross hair (plus tolerances to the right and minus tolerances to the left). A second 5-inch gauge is printed at the bottom to check both longitudinal and perpendicular transverse center line spacing. REMEX specifies tape registration for the RPM612X to be between 0.015 short and 0.015 long in a span of 5-inches.

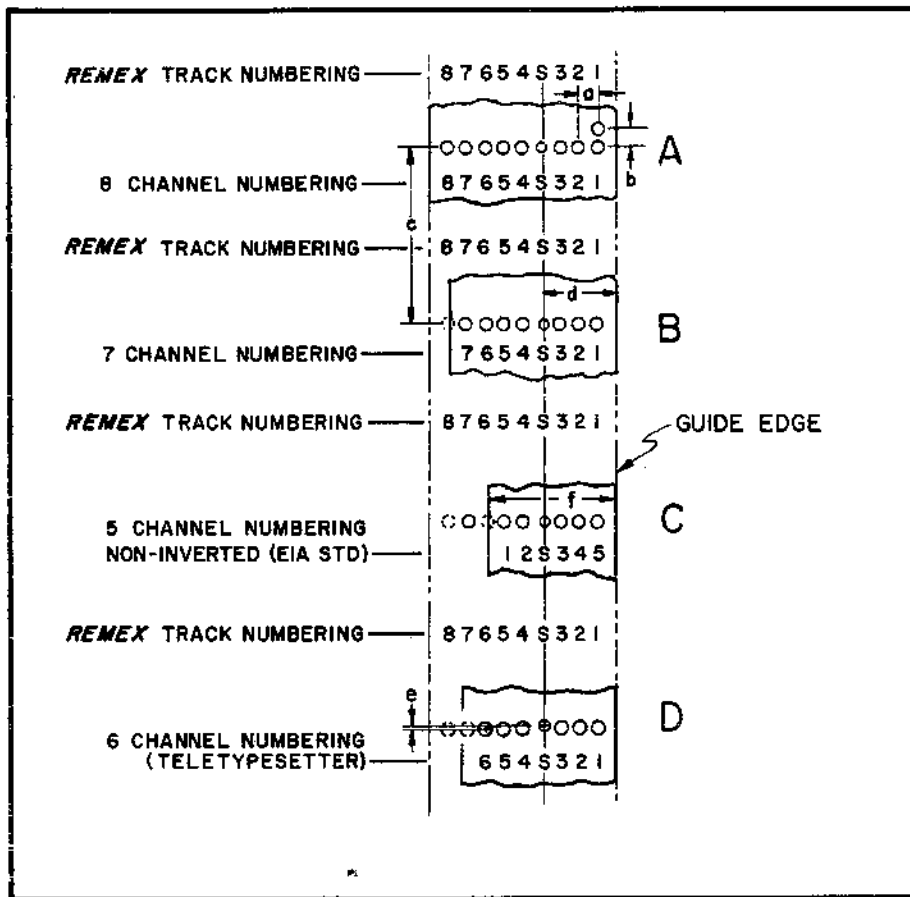

MMC 243

Tape Configuration	d dimension ± 0.004	f dimension ± 0.003	In All Configurations
A	0.392	1.000	a = 0.100 ± 0.002 b = 0.100 ± 0.003 c = in span of 1 inch is ± 0.010 in span of 5 inch is ± 0.025 e = $.013 \pm .001$ Data Hole Diameter = $0.072 \pm .002$ Sprocket Hole Diameter $0.046 \begin{matrix} +.002 \\ -.001 \end{matrix}$
B	0.392	0.875	
C	0.395	0.686	
D	0.434	0.875	

Figure 1-5. Tape Configurations Available.

NOTE

7 Channel tapes not applicable to this punch.

SECTION II

INSTALLATION AND INTERFACE

2.1 UNPACKING

Specially designed, reinforced packing cartons have been used in the shipment of the RPM612XBAB to provide protection during transit. A careful visual inspection of the unit should be made as soon as it is removed from the carton for any apparent damage incurred during shipping. In the event the unit has been damaged as a result of shipping, the carrier and REMEX should be notified as soon as possible.

2.2 MOUNTING

The unit has been designed for stationary ground equipment. Mounting dimensions are shown in Figure 1-3. Shock mounts and/or vibration isolators are recommended for mounting in other systems to reduce noise and vibration levels within the equipment used. A blower must be provided to maintain motor heat sink temperature at 60°C max. during continuous 120 cps operation at 25°C ambient. The specification for supply tension as described in Table 1-1 must also be followed.

2.3 INITIAL ADJUSTMENTS

Each unit has been accurately adjusted and aligned before leaving the factory. No adjustments or calibrations are required prior to installation or use.

2.4 INTERFACE

The schematic for the punch is given in Figure 8-1. The stepper motor and punch solenoids are connected through the input connector. Suggested drive circuits for the solenoids and motor are given in Figure 2-1. Punch operation and timing is discussed in Section 3. Table 2-1 lists the interface signals for the RPM612XBAB.

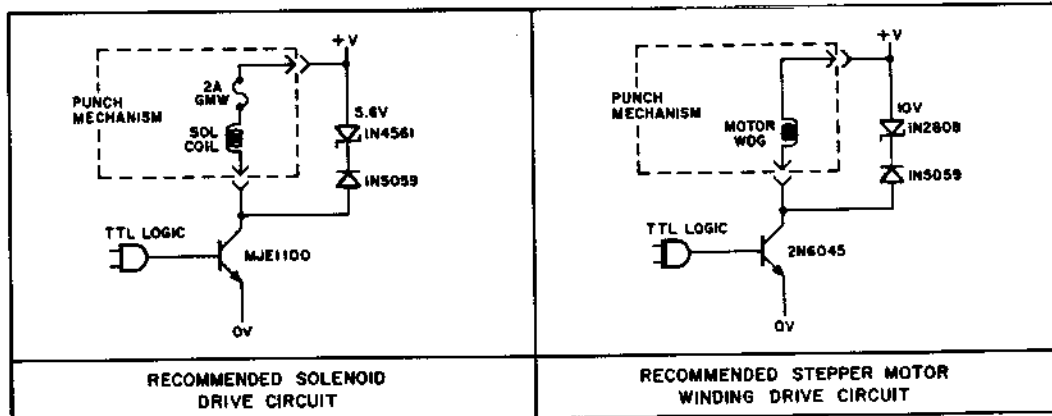

MMC 523

Figure 2-1. Suggested Drive Circuits.

Table 2-1. Interface Signals, RPM612XBAB

Pin	Function	Pin	Function
1,4	+24V	9	Feedhole Solenoid Return
2	Solenoid 4 Return	10	Stepper Motor Common
3	Solenoid 8 Return	11	Stepper Motor $\phi 2$
5	Solenoid 6 Return	12	Stepper Motor $\phi 3$
6	Solenoid 7 Return	13	Solenoid 2 Return
7	Stepper Motor $\phi 3$	14	Solenoid 1 Return
8	Solenoid 5 Return	15	Solenoid 3 Return

Note: The interface connections and schematic for the RPM612XBAA are shown on the system schematic in which it is installed.

SECTION III

OPERATION

3.1 STEP MOTOR DRIVE

A 24-tooth sprocket wheel driven by a three phase stepper motor is used to drive tape either forward or backward. The direction of tape travel is determined by the energizing sequence of the phases in the following manner: forward motion, ϕ_1, ϕ_3, ϕ_2 ; backspacing, ϕ_1, ϕ_2, ϕ_3 . Backspacing should be limited to 10 lines. Figures 4, 5, 6, 7 and 9 of Figure 3-1 give the operational characteristics of the stepper motor. Each step requires an initial 70 volt, 2 ms pulse applied to the appropriate motor phase to increase the acceleration rate (Figures 4 and 9 of Figure 3-1). One ms after the beginning of the step pulse, the remaining two phases are also turned on with a 70V pulse for 1 ms to minimize the oscillations in the motor. After 2 ms, the active phase voltage is reduced from 70 to 35 for the remaining step period and the entire punch cycle.

Figure 2-1 gives a recommended drive circuit for the operation of the motor winding. Note the diode and 10V Zener required to discharge the inductive energy stored in the motor winding. Table 1-1 gives the electrical specifications for the stepper motor. It is also important that a blower be provided to maintain the motor heat sink temperature at 60°C max. during continuous 120 cps operation at 25°C ambient.

3.2 PUNCH SOLENOID DRIVE

The punch solenoids are driven by voltage pulses from a voltage source, V , that can be any value between 23 and 35 Vdc. The solenoid on time as a function of the supply voltage is given in Figure 1 of Figure 3-1. Figures 2 and 3 of Figure 3-1 show the solenoid input current and decay current as a function of time. For example a 25V source would require a 1.9 ms on time.

Figure 2-1 shows a recommended circuit for the solenoid operation. It should be noted that the inductive energy of the punch solenoid is discharged via a diode against a voltage that is approximately 6V higher than the drive voltage, thus providing a faster current drop. Table 1-1 gives the electrical specifications for the solenoids.

3.3 SYNCHRONIZATION OF TAPE FEED AND PUNCHING

Referring to Figure 9 of Figure 3-1, the operating cycle begins with the tape feeding cycle as described in Section 3.1. A time of 4.1 ± 0.1 ms is required to position the tape into place and ensure that all oscillations in the motor have stopped. At the end of this period, the solenoid is energized for a period of time depending upon the voltage used as described in Section 3.2. Figure 8 of Figure 3-1 gives the pin travel characteristics as a function of time and indicates that after 8 ms from the initial step pulse, the

pin has retracted sufficiently to allow the next cycle to begin. An extra 0.33 ms is added as a margin of safety making the total step-punch cycle 8.33 ms min. It is not recommended that the operating sequence be reversed, i.e., punching and then feeding.

3.4 TAPE RECOMMENDATIONS

Table 3-1 lists the tapes REMEX recommends for use. Basic tape specifications are given in Table 1-1.

Table 3-1. Acceptable Tapes

REMEX has found the following tapes acceptable for use with the RPM612X.

Type	Manufacturer	Part Number
Paper, Unoiled or Oiled (see note) except black carbon filled tapes	REMEX	1000 ft Roll, 715200-002 1000 ft Fanfold, 715200-001
	Paper Manufacturer's Inc.	Perfection Series
	Bemis	Paper Tape Series
	Crown Zellerbach	Paper Tape Series
	Friden	Paper Tape Series
Special Paper (roll only)	Nova Tech	Syntosil Machine Tool Tape
Special Mylar, Paper-Mylar or Polyester (roll only)	Numeridex	2000
	Arvey	RVCZ 60, RVCT 52
	Chase Foster	PMP01151

NOTE: Oiled paper tapes may be used but with more frequent punch cleaning periods. **ALSO ACCEPTABLE BUT WITH REDUCED PUNCH LIFE: Black Carbon Filled Tapes. NOT ACCEPTABLE FOR THIS PUNCH APPLICATION: Mylar-Foil, Numeridex #0500, all vulcanized fiber tapes, Chase Foster MFM-153515 and MFM-103515, and 3M Brand N/C Tape #401, 301, and 3137.**

3.5 TAPE LOADING AND STARTING

The threading of the tape through the punch is shown in Figure 3-2. To load tape, first depress the punch LOAD button. This will rotate the pivot tape guide allowing access to the sprocket. Thread tape under the edge guide assembly, through the punch block, over the sprocket and out through the tape drive assembly. Close the pivot tape guide. When starting a new roll of unpunched tape, allow a few feet of feed holes only to be punched so that the sprocket holes engage properly with the sprocket teeth. Under some conditions, especially with stiff tapes it may be necessary to give a slight tug to start the tape and engage the feed holes.

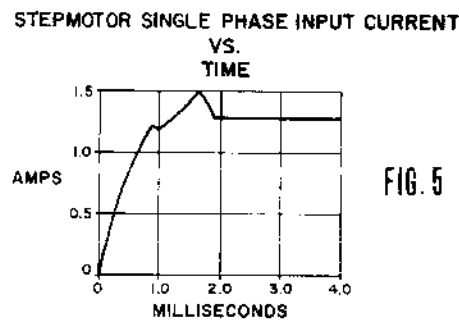
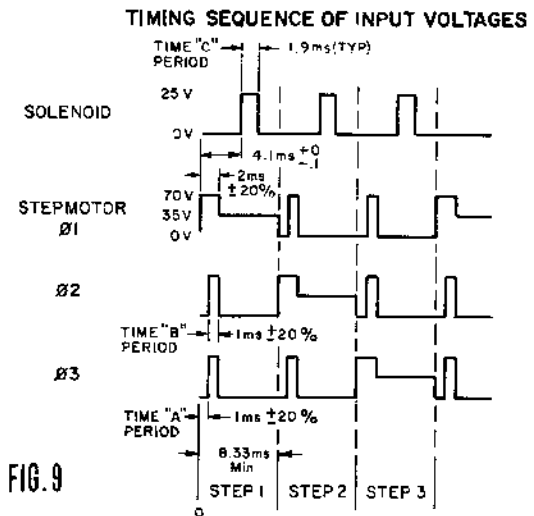
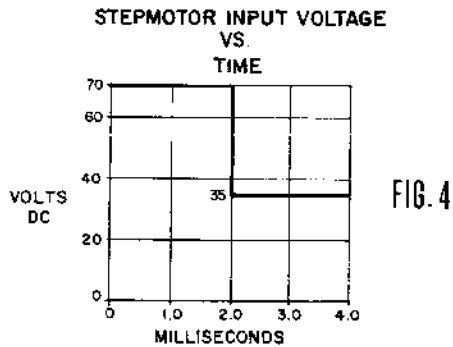
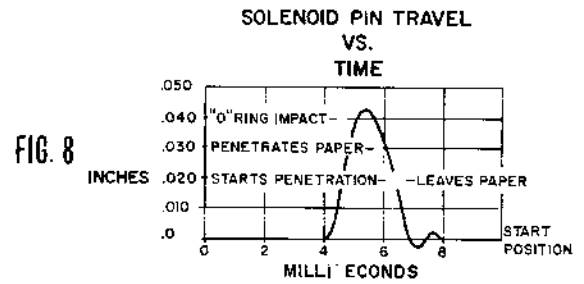
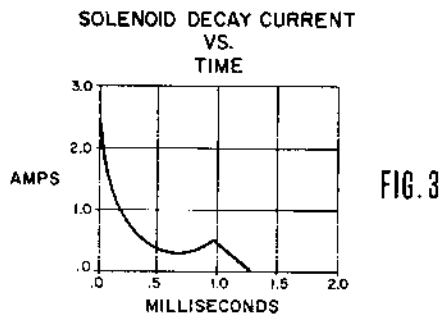
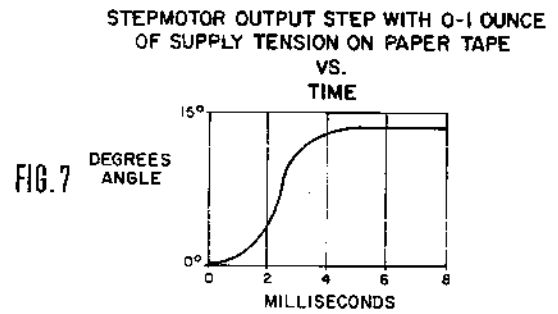
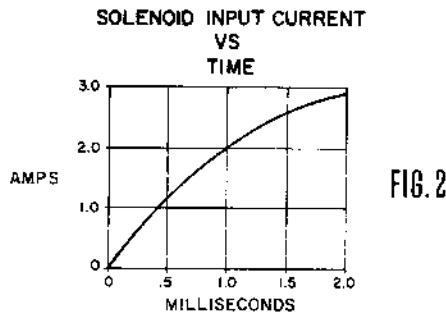
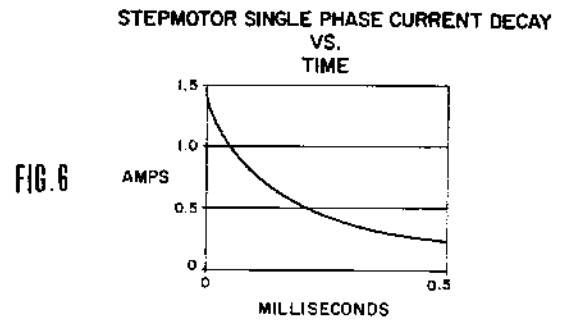
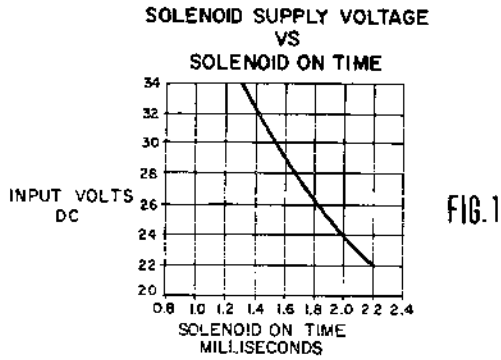

MMC522

Figure 3-1. RPM612X Punch Mechanism Timing Diagrams.

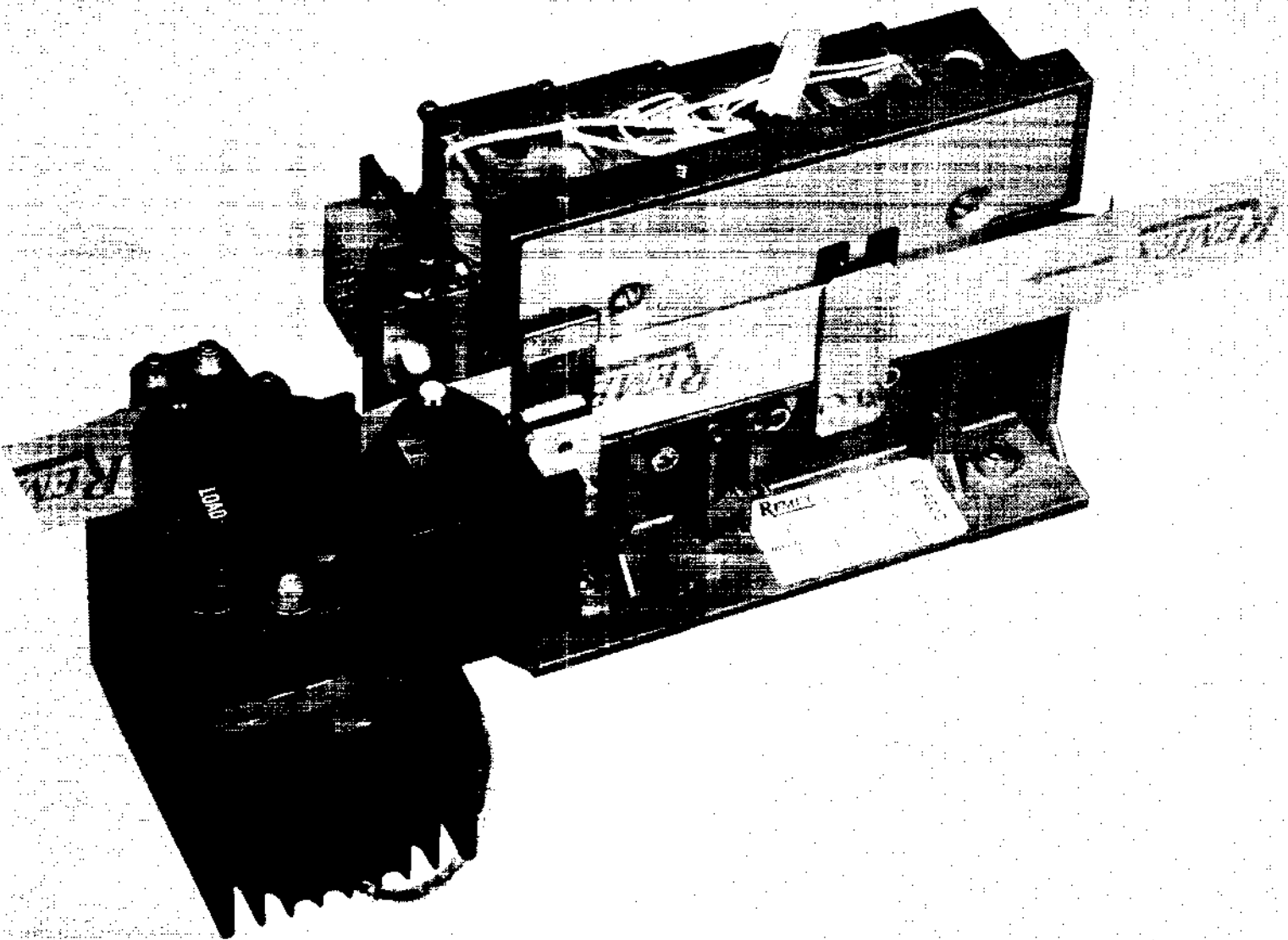

Figure 3-2. Tape Threaded Through The Punch Mechanism.

SECTION IV

THEORY OF OPERATION

4.1 GENERAL

The REMEX tape punch mechanism, Model RPM612X, basically consists of three parts: (1) the tape pathway with a reference edge against which the tape runs, (2) the tape drive assembly consisting of the stepper motor and sprocket and (3) the punching mechanism consisting of the punch solenoids, punch pin drive linkage and punch and pin block. Each of the three items is described in Sections 4.2 through 4.4.

4.2 TAPE PATHWAY

The tape pathway is designed with a reference edge against which the tape runs. A leaf spring is provided at the input of the punch to aid in tape guiding and to cushion acceleration shock as tape is stepped. Except for a .042" lower edge for the 6 track typesetter, the same reference surface is used for both 5, 8 and 6 track typesetter. A different punch block is also used for the 6 track typesetter.

4.3 TAPE DRIVE

A three phase stepper motor is used to drive tape in conjunction with a 24-tooth sprocket. The energizing sequence of the motor phases determines the direction of tape travel as follows: forward motion, θ_1 , θ_3 , θ_2 ; backspacing, θ_1 , θ_2 and then θ_3 . Operation of the motor is described in Section 3.1. Each step of the motor rotates the sprocket 15° and advances the tape 0.1 inch.

Electronic control is used to critically dampen the motor when stepping from one line to the next. One millisecond after the motor has been stepped, the remaining two motor phases are also turned on for a period of 1 ms. No external brake is required. Timing relationships between the tape feed and punching are discussed in Section 3.3.

4.4 TAPE PUNCHING

The punch mechanism consists of nine punch solenoids, the punch pin drivers, the punch pins and the punch head. Punching takes place when one or more punch solenoids are energized. The stepper motor first advances the tape 0.1 inch to the area directly under the punch and pin block assembly. When the solenoid is energized, its actuator turns and moves punch pin driver. The punch pin driver turns about its shaft which operates the punch pin and causes a hole to be punched in the tape. When the punch solenoid is de-energized, the punch pin and punch pin driver are returned to their initial positions.

Four types of punch blocks are available as designated by the seventh digit in the model number: (1) 8-Track Steel Block, RPM6121BAX, (2) 8-Track Carbide Block, RPM6122BAX; (3) 6-Track Steel Block, RPM6123BAX and (4) 6-Track Carbide Block, RPM6124BAX. Carbide punch blocks exhibit approximately three times the life of the steel punch blocks. All data on punch block life is based on approved paper tape.

SECTION V

MAINTENANCE

5.1 GENERAL

The tape punch mechanism has been designed to keep maintenance as simple and infrequent as possible. To prolong the life of the punch and minimize downtime, certain checks and preventive maintenance procedures have been set up in Section 5.3 and Table 5-1 along with suggested schedules. Section 5.4 outlines replacement procedures which can be performed in the field.

When any part requires replacement or disassembly, the procedures outlined below should be followed closely. The warnings and cautions are included to protect personnel and equipment. Notes are included to assist persons unfamiliar with the equipment. Before attempting any procedure, all instructions for that disassembly should be read and understood. Items suggested as spare parts are listed in Table 7-1. All units parts at the replacement level are identified in Figure 7-1.

5.2 REMEX SERVICE

REMEX maintains service facilities at its manufacturing location and at service centers in major population areas for repair or replacement of components for their products. It is recommended that one of these centers be contacted for assistance in case of equipment malfunction. For the locations of service facilities in any area, contact REMEX at the address listed on the title page of this manual. Please direct inquiries to the attention of the Service Department. Always reference the complete model number and serial number when making inquiries.

5.3 PREVENTIVE MAINTENANCE

Preventive maintenance, which includes checking, cleaning and lubrication, should be performed periodically in order to maintain peak performance. In addition, in order that the warranty remain in effect, the unit must be maintained in accordance with the instructions outlined below. A preventive maintenance schedule and log is presented in Table 5-2 which indicates the frequency of action and maintenance procedure. For customer convenience the table is arranged so that a log can be kept of when each maintenance procedure was performed. Table 5-1 lists the maintenance equipment required.

Perforator preventive maintenance and servicing should be undertaken at intervals determined by the number of rolls of tape punched (1000 ft/roll). These intervals are 100 (50 for certain types of tape) and 700 rolls.

Table 5-1. Special Maintenance Equipment Required

Description	REMEX Part No.	Quantity
Tape Gauge	110597	1
Set Gauge	400614-1	1
Tape Gauge, 8-Track	400622-1	1
Tape Gauge, 6-Track	400622-2	1
Feed Hole Pin	400628	1
Spring Gauge, 100 gram Haldex AB or equivalent	-	1
Curved Shim Stock, 0.004" thick	-	1
Feeler Gauge, 0.015" thick	-	1
Molex Extractor Tool HT2285	-	1
Shim, 0.003" thick	-	1
Torque Wrench, Utica Model TS-30 or equivalent with special adapter HW-18. Also requires Hex Key 7/64 (HW-5A) and Hex Key 9/64 (HW-5A).		

Items without REMEX Part Numbers are not available from REMEX.

5.3.1 100 ROLL SERVICE (50 FOR CERTAIN TYPES OF TAPE)

100 (50)-roll service is carried out by the customer. It requires dust and chad removal cleaning, lubrication and a functional check. When punching certain types of tapes, especially those containing adhesives which laminate two or more layers such as many of the mylar tapes, the holes in the punch block require cleaning every 50 rolls of tape.

5.3.1.1 Lubrication

Lubrication of the punch head must be performed every 100 rolls of tape. Detail instructions are given in Figure 5-1 (drawing 112210) which is also included in every kit of parts.

Table 5-2. Preventive Maintenance Log

Frequency No. of Rolls	Date	Initial	Frequency No. of Rolls	Date	Initial	Section								
						5.3.1.1	5.3.1.2	5.3.1.3	5.3.2.1	5.3.2.2	5.3.2.3	5.4	5.5	
* 100			1500			X	X	X						
200			1600			X	X	X						
300			1700			X	X	X						
400			1800			X	X	X						
500			1900			X	X	X						
600			2000			X	X	X						
700			2100			X	X	X	X	X	X	X	X	X
800			2200			X	X	X						
900			2300			X	X	X						
1000			2400			X	X	X						
1100			2500			X	X	X						
1200			2600			X	X	X						
1300			2700			X	X	X						
1400			2800			X	X	X	X	X	X	X	X	X

*If laminated Mylar tapes are used, these intervals must be every fifty (50) rolls.

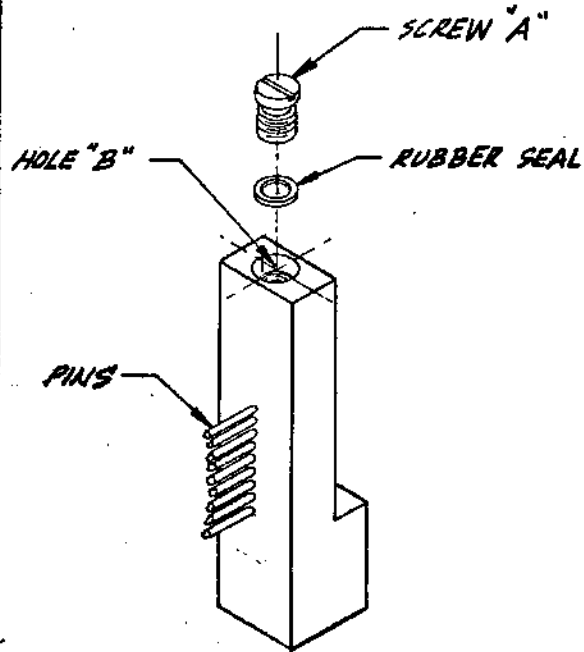

SYM	ECO	EFFECT	REVISIONS	BY	DATE	APPRD
A	-	8-19-74	RELEASED	S.G.	8-19-74	ME
B	14801	12-16-74	REVISED NOTE 1		12-16-74	ME

1. THE PUNCH HEAD MUST BE REGREASED EVERY 100 ROLLS OF TAPE.
2. FOR SERVICE, REMOVE SCREW "A" WHICH SERVES AS PLUG FOR THE GREASE CAVITY. USE CARE NOT TO LOSE THE RUBBER SEAL THAT GOES UNDER THE SCREW HEAD.
3. FILL THE CAVITY WITH GREASE FROM THE TOP (B HOLE) UNTIL IT OVERFLOWS. USE GREASE AND SYRINGE (REMEX NO.'S 716004-163, 716056-108) SUPPLIED IN KIT OF PARTS.
4. WHILE PUNCHING ALL HOLES IN UNOILED, PAPER TAPE, FORCE GREASE INTO THE HEAD UNTIL A SLIGHT TRACE OF GREASE WORKS OUT ALONG THE PINS.
5. REPLACE SCREW "A" AND ITS RUBBER SEAL.
6. CONTINUE PUNCHING ALL HOLES IN UNOILED PAPER TAPE FOR AS LONG AS REQUIRED TO STOP SEEING TRACES OF GREASE ON THE TAPE.

REQD.	PART NUMBER	DESCRIPTION	DESIGNATION	NOTE	ITEM
LIST OF MATERIALS					
UNLESS OTHERWISE SPECIFIED DIMENSIONS ARE IN INCHES		DR. S. Colan	 1733 ALTON STREET SANTA ANA, CALIF. 92705 <small>A UNIT OF EX-CELL-O CORPORATION</small>		
TOLERANCES: FRACTIONS DECIMALS ANGLES ± 1/32 XX ± .02 ± 1/2 XXX ± .01		DATE 8-15-74			
SURFACE ROUGHNESS ✓ BREAK SHARP EDGES .020 MAX.		CHK ME	TITLE GREASING INSTRUCTIONS - PUNCH HEAD RPM212XXX/		
MATERIAL		DATE 8-15-74			
FINISH		APP. WJG	CODE IDENT. NO. SIZE DWG. NO. REV. B 112210 B		
RPM612X		DATE 8-15-74			
USED ON	NEXT ASSY.	APPROVAL	SCALE NONE		
		OUTSIDE APP.	DO NOT SCALE DRAWING SHEET 1 OF 1		

- NOTICE -
THIS DRAWING IS THE PROPERTY OF REMEX, A UNIT OF EX-CELL-O CORPORATION AND EMBODIES A CONFIDENTIAL PROPRIETARY DESIGN IN WHICH REMEX RETAINS ALL PATENT AND OTHER RIGHTS INCLUDING EXCLUSIVE RIGHT OF USE, MANUFACTURE AND SALE. IT IS SUBMITTED UNDER A CONFIDENTIAL RELATIONSHIP FOR A SPECIFIC PURPOSE, AND THE RECIPIENT AGREES, BY ACCEPTING THIS DRAWING, NOT TO SUPPLY OR DISCLOSE ANY INFORMATION REGARDING IT TO ANY UNAUTHORIZED PERSON.

Figure 5-1. Punch Head Greasing Instructions.

5.3.1.2 Punch Cleaning

Remove all dust, dirt and chad from the perforator using a dry cloth and/or compressed air. Clean the motor and tape path using the same materials. Punch cleaning can be best perform by using the following procedure. This procedure is particularly useful when the perforator has been punching the laminated mylar tapes. The necessity for cleaning will be evidenced by incomplete perforations in the tape and columns of chad having accumulated in the punch holes. Access to the holes is accomplished by removing the chad box. The following cleaning procedure is recommended:

- a. Insert a 0.003 stainless shim in the 0.008 gap between the guide block and the die post. Refer to Figure 5-2. This will protect the guide block and pins and prevent debris from contaminating this area.

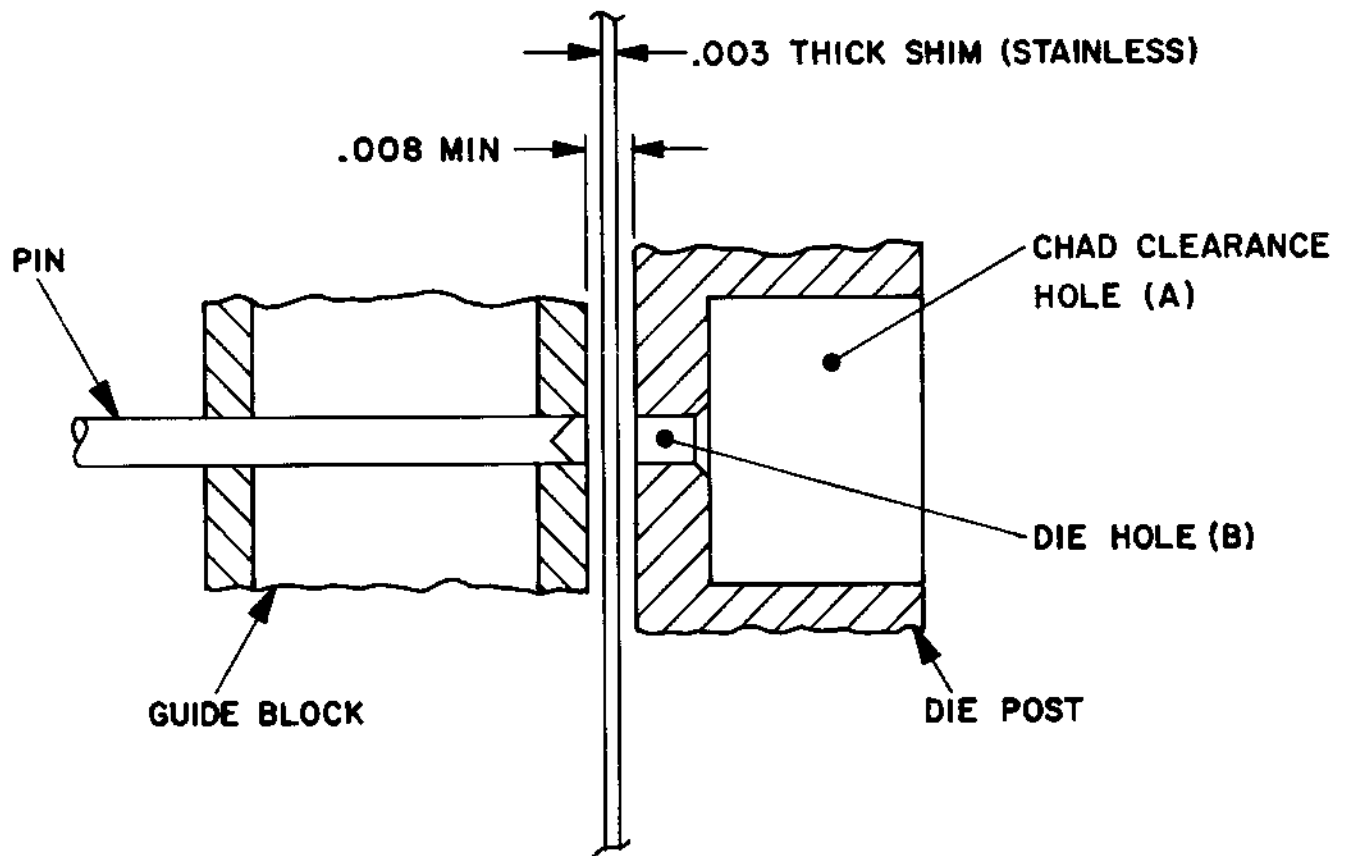

MMC 574

Figure 5-2. Die Post Hole Cleaning Procedure.

- b. Using a wire brush or reamer, force the chad in hole B into the 0.008 gap and against the shim. Starting at the top hole, swing the shim in and out, thereby removing the chad from the punch. Continue until hole B is clear. Repeat for all nine holes.
- c. Using a wire brush or hand held reamer and a solvent such as trichlor, mechanically remove all debris adhering to the walls of hole A. Use a magnifying glass and visually inspect the walls of both A and B. If required use a pipe cleaner with trichlor to remove all loose debris. Make sure the protective shim remains in place during this cleaning.

5.3.1.3 Registration

Check registration of the punch tape to make sure tape error falls between 0.015 inch short and 0.015 inch long in a span of 5 inches using paper and mylar tape. If the tape is out of registration, perform Section 5.4.

5.3.2 700 ROLL SERVICE

Sections 5.3.2.1 through 5.3.2.3 list those items to be checked after each 700-rolls (1000 ft. roll) of tape have been punched. Normally these items are performed at a central workshop where the required facilities and equipment are available.

5.3.2.1 100 Roll Service

The 100 roll service described in Section 5.3.1 should also be performed at this time.

5.3.2.2 Wear Checks

Check for excessive wear on the following items:

- a. Punch pins and block assembly reduction of 0.001 or greater at cutting edge diameter.
- b. Pin driver assembly. Check for sufficient elongation of plastic at punch pin head and stop pin pivot to produce 0.010 or greater lost motion in pin stroke.
- c. Spring and sleeves on solenoid. Replace worn plastic eyelets as required.
- d. Replace all cracked chipped or broken "O" rings.

5.3.2.3 Bearing Checks

Check for any brinelling or friction torque in any of the following items and replace as required:

- a. Step motor ball bearings (replace step motor).
- b. Solenoid ball bearing (replace solenoid assembly).
- c. Pin driver plastic bearing (replace pin driver).

An important feature of the REMEX RPM612XBAX perforator mechanism is the ability to achieve accurate registration of tape holes. All units are set at the factory for an error of between 0.015 inch short and 0.015 inch long in a span of 5-inches using paper and mylar tapes. Since this alignment is critical it is recommended that registration be checked first in steps a and b and if the registration is not correct then perform the remaining procedure. All steps are to be performed under full operating temperature stabilized condition, i.e., static on time of the perforator motor for 5 minutes with a blower moving air over the motor. During 120 cps operation, the blower must maintain the heat sink at less than 60°C. All solenoids must be fuse protected. Model RPM612X-BAA (units contained in a REMEX system) requires that the "Perforator Logic Timing Adjustments" as described in the particular system manual be performed.

Model RPM612XBAB (units sold individually) require that an all hole pattern be run at 120 cps. Adjust time period "A" in Figure 9 of Figure 3-1 between the limits shown to obtain the sharpest sprocket tooth image (minimum oscillation or resonance of sprocket tooth) under 4-power viewing. Repeat for time period "B". Alternate between both time periods for least sprocket resonance.

Refer to Figure 7-1 which can be folded out from Section 7 during the following steps. Items in parenthesis refer to hardware illustrated in Figure 7-1.

- a. With proper timing and damping signals, run an all hole pattern at 120 cps.
- b. Check the registration in a 5-inch span which must be between 0.015 short and 0.015 long. If the registration falls outside these limits, perform the remaining procedure.

WARNING

If the motor has been running for an extended period of time, it or the heat sink may be too hot to touch comfortably. It is recommended that either the motor be allowed to cool or a pair of gloves be used on the following adjustment.

- c. Remove the two 4-40 x 1-3/8" socket head screws (A), flat and lock washers which hold the fixed tape guide to the tape drive assembly.
- d. Remove the three 4-40 x 1" socket head screws (B), flat and lock washers which hold the tape drive assembly to the perforator housing.
- e. Insert REMEX tape gauge 400622-1 (8-track) or 400622-2 (6 track) into the punch. Insert a feed hole pin from the chad side through both the feed hole in the block and the gauge to hold the tape gauge in position. It may be necessary to remove the chad tube and clean the punch block before inserting the feed hole pin. Refer to Section 5.3.1.2. Make sure the reference edge of the gauge is flush and parallel with the reference edge of the punch block. Refer to Figure 5-3.

- f. Check to see that the sprocket is correctly placed on the motor shaft so that the teeth are concentric with the feed holes in the gauge. Refer to Figure 5-3.
- g. If the conditions of step f do not exist, loosen the two set screws which hold the sprocket (C) to the motor shaft and slide the sprocket in towards the motor. Remove the delrin disk 111736-1. The delrin disk is press fit on the shaft but should slide off without using excessive force. Slide the sprocket out until the conditions in step f are met. Check the condition of the socket head and threads on the sprocket set screws and replace if they show signs of wear. Tighten one set screw. The REMEX part number for these screws is 713000-121.
- h. Energize the motor by placing +28 Vdc across the brown and black motor wires.
- i. Check to see that the sprocket teeth are concentric and equal penetration on both the left and right side of the sprocket center line. Refer to Figure 5-3.
- j. If the conditions in step i do not exist loosen the screw (D) which holds the heat sink to the motor and remove the heat sink. Note heat sink orientation for proper reassembly.
- k. Loosen slightly the three 4-40 socket head screws (E) which hold the motor mounts to the perforator housing. The screws are loosened only slightly so that the in or out position of the sprocket does not change.
- l. Rotate the motor until the conditions of step i are present. If it is necessary to move the sprocket in or out slightly loosen the set screw (C), move the sprocket as required and tighten both set screws. Tighten the three motor mount screws. Recheck the concentricity and penetration. Repeat step i through l as required. Remove the tape gauge and feed hole pin.
- m. Replace the delrin disk by sliding it on the motor shaft next to the sprocket.
- n. Replace the heat sink. Note that the short side of the heat sink is flush with the side plate side of the punch. See Figure 7-1. Tighten heat sink screw (D).
- o. Replace the drive assembly but do not tighten the three screws (B).
- p. Insert a 0.004" curved shim stock between the tape guide pivot on the tape drive assembly and the delrin disk. Position the tape drive assembly so that the spacing shown in Figure 5-4 is 0.004 inch. Tighten the three screws. Recheck the gap. The screws marked B in Figure 5-4 are the same three screws marked B in Figure 7-1.
- q. Replace the fixed tape guide and adjust the fixed tape guide so that the gap between the fixed tape guide and the tape guide pivot is between .010 and .020 inch. Refer to Figure 5-5. Tighten the two screws (A). The screws marked (A) in Figure 5-5 are the same two screws marked (A) in Figure 7-1.

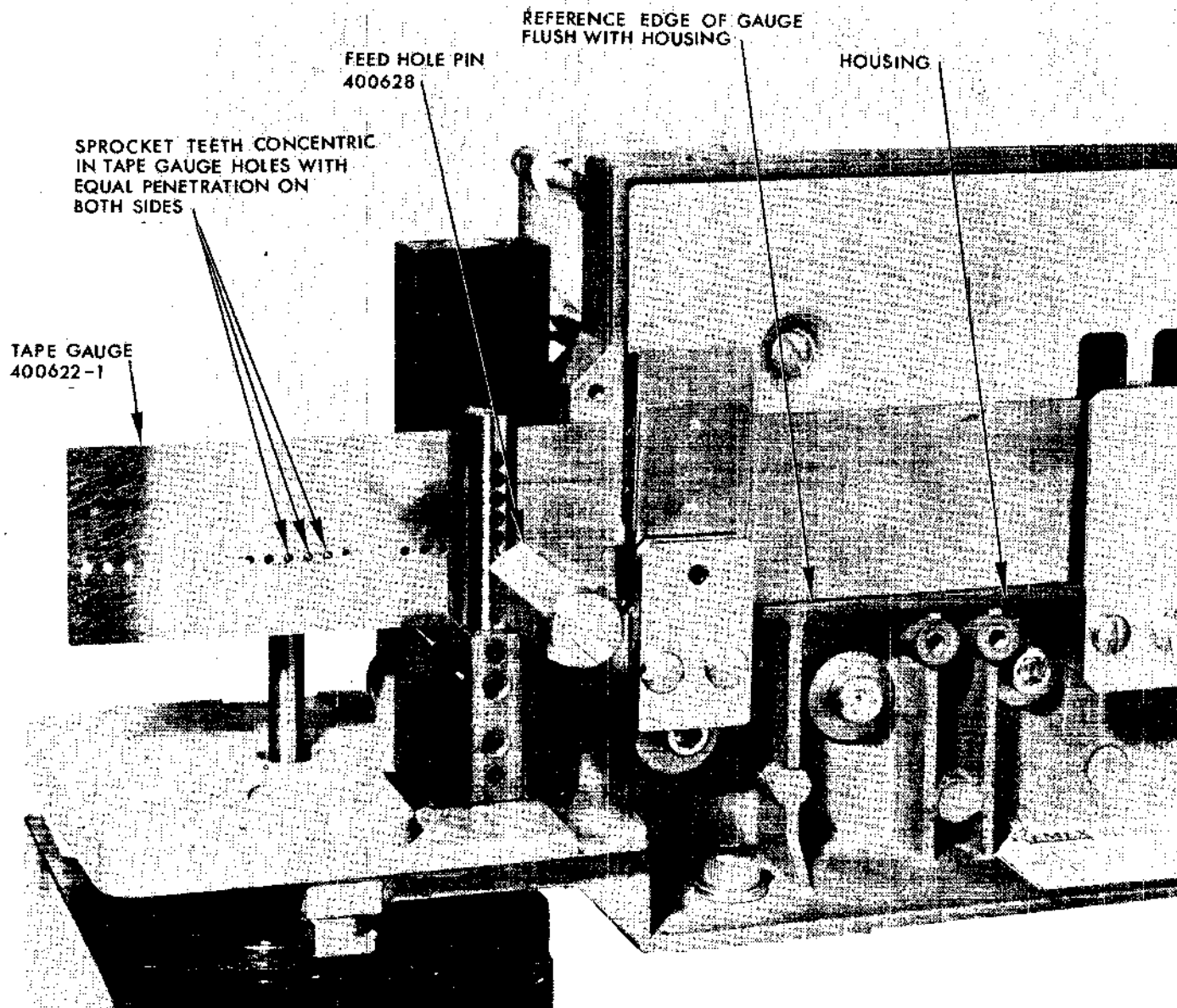

Figure 5-3. Sprocket Alignment Using Tape Gauge.

- r. Run paper tape at 120 cps and at 15 cps with all holes, a data pattern and then 1 hole at a time and check the registration of each. Repeat with mylar tape. Check the registration of each run.
- s. If the registration is not as described in step b, loosen the three 4-40 socket head screws (E) slightly which holds the motor mounts to the housing and the heat sink screw (D). With the tape drive assembly mounted, two screws are accessible through holes in the tape drive assembly; the other screw is visible.

NOTE

This step is similar to that performed in step k and l but with the tape drive installed and will be used to finely adjust the registration.

- t. Rotate the motor slightly to correct the registration error. Long errors require counterclockwise rotation (facing shaft end) and short errors require clockwise rotation. Only a small rotation is required. A 0.020 movement at the motor housing perimeter is sufficient to change the registration from 0.022 long to 0.022 short in 5 inches. The motor must remain energized during this adjustment. Care should be taken so that the motor is not moved in or out so that the setting in steps e and f are not disturbed. Tighten the three screws and the heat sink screw.
- u. Repeat steps r, s and t until the desired registration is achieved.
- v. On model RPM612XBAB, run tape using an all hole pattern. Measure the actual solenoid voltage and from Figure 1 of Figure 3-1, determine the solenoid on time.
- w. Using the solenoid on time determined in step p, adjust time "C" in Figure 9 of Figure 3-1 for that amount. Units contained in a REMEX system has this time set when the Perforator Logic Timing Adjustments were made.

5.5 PUNCH PIN DEPTH ADJUSTMENT

This procedure is used to set the punch pins to the proper depth. A set gauge, REMEX Part Number 400614-1 is required to make this adjustment.

- a. Remove the screw (F) which holds the chad tube to the punch and pin block assembly and remove the chad tube.
- b. Clean the chad out of the Punch and Pin Block Assembly. Refer to Section 5.3.1.2.
- c. Place REMEX set gauge 400614-1 on a smooth flat metal surface and turn dial face until the indicator is at zero.

NOTE

Use the 0.069 adaptor for data tracks. Do not use the 0.043 adaptor for these tracks but for the feed hole only.

- d. Pull up on the indicator knob and slide the set gauge on the Punch and Pin Block die as shown in Figure 5-6. Gently lower the indicator knob into track 1 until the adaptor contacts the punch pin. Note the dial reading which should be 0.015 ± 0.001 .

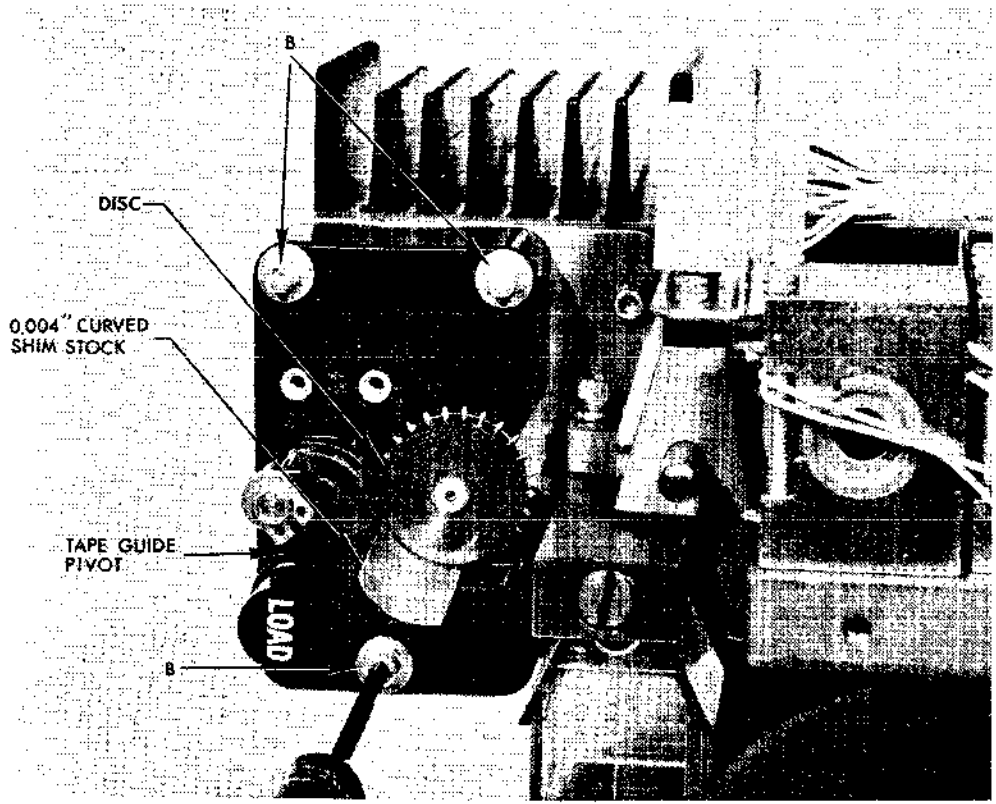

Figure 5-4. Tape Drive Assembly Alignment.

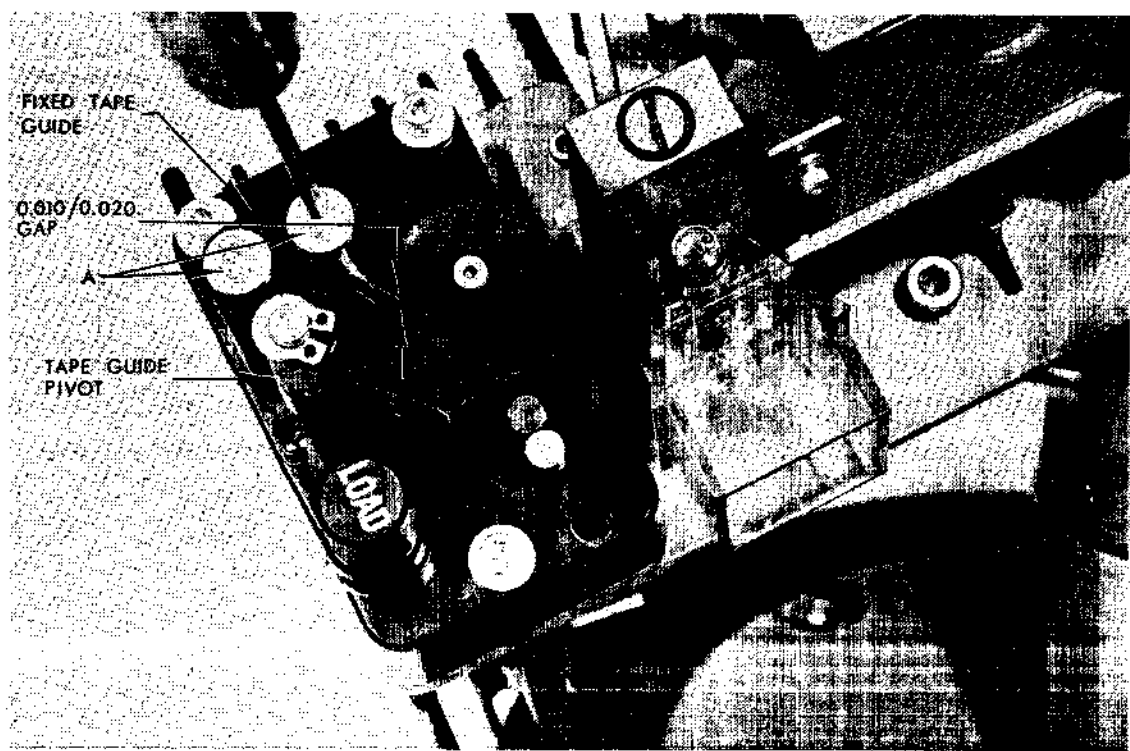

Figure 5-5. Fixed Tape Guide Alignment.

- e. If the condition in step d is not present, loosen screw (G) which holds the track 1 solenoid to the perforator housing and adjust the solenoid until the conditions in step c are met. The solenoid is adjusted by walking it back and forth along its ridge. Tighten screw (G) to 20-inch pounds. Use a torque wrench to establish this torque. The solenoid screw labeled (G) in Figure 5-6 is the same screw labeled (G) in Figure 7-1.

NOTE

The solenoid screws for tracks 4-8 are located under the Side Plate. When removing the side plate use care that the two washers on the under side are not lost.

- f. Check to make sure that the solenoid is setting straight. It is possible to obtain a correct pin depth without the solenoid being straight.
- g. Repeat steps d, e and f for each of the other seven data tracks.
- h. Install the 0.043 adapter and repeat steps c, d, e and f for the feed hole track.
- i. Remove the set gauge and replace the Chad Tube and screw (F).
- j. Replace the Side Plate if tracks 4-8 were adjusted. Make sure the washers go on the inside of the plate.

5.6 EDGE GUIDE ASSEMBLY ADJUSTMENT

The following adjustment is factory set and should not be changed unless replacing the edge guide assembly.

- a. Place one layer of mylar tape between the edge guide assembly and the side plate. See Figure 5-7.
- b. Attach a spring gauge at the rear of the tape and pull the tape through the edge guide assembly. The tape tension should be 20 ± 5 grams.
- c. If the conditions of step b are not present, adjust set screw (S) until the required tension is present.
- d. Lock the set screw with Loctite.

5.7 TROUBLE SHOOTING

Trouble shooting is presented in the form of a chart, Table 5-3, which should be consulted whenever the performance of the system is unsatisfactory. The chart is divided into three columns: Indication – the observed malfunction in the performance of the perforator, Probable Cause – the possible reason or reasons for the malfunction and Remedy – the manner in which the malfunction may be corrected. These procedures assume that the proper input signals are being applied and that all connectors are properly mated and functioning.

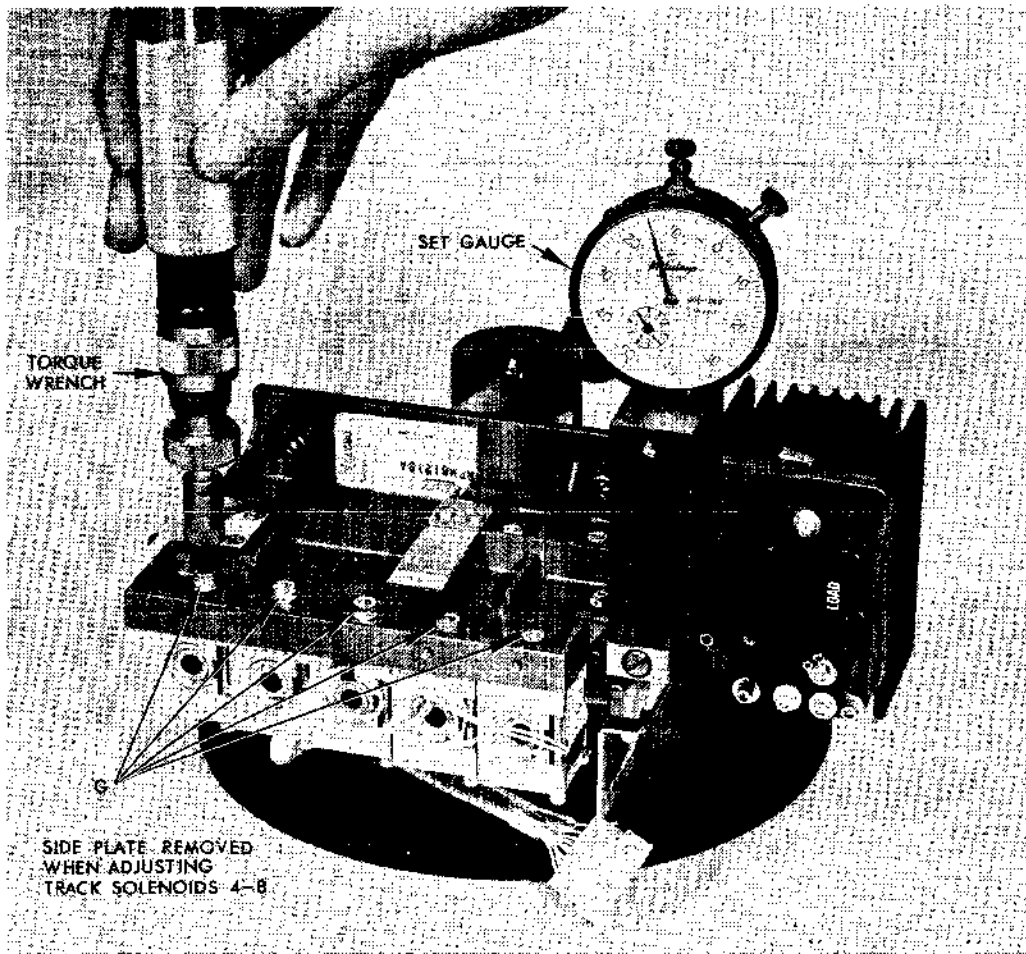

Figure 5-6. Setting Punch Pin Depth.

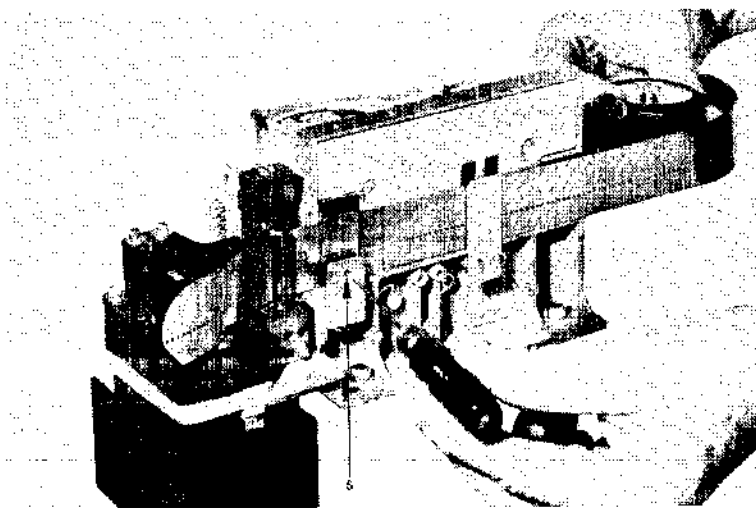

Figure 5-7. Adjustment of Edge Guide Assembly.

Table 5-3. Troubleshooting Chart.

Indication	Probable Cause	Remedy
1. Hole(s) not punching all the way through.	1. Punch pin depth improperly set.	1. Check punch pin depth as described in Section 5.5 and adjust as required.
	2. Solenoid Faulty.	1. Check operation of solenoid and replace if required as described in Section 6.5.
2. Punched hole burring, especially feed hole.	1. Electronic drive circuit faulty.	1. Check the timing and damping in the electronic drive circuits.
	2. Registration out of alignment.	1. Check registration alignment and perform Section 5.4 as required.
	3. Solenoid faulty.	1. Check operation of solenoid and replace if required as described in Section 6.5.
3. Registration of holes with edge of tape improper.	1. Alignment of housing punch block or sprocket wrong.	1. Check registration alignment and perform Section 5.4 as required.
	2. Tape Guide and/or edge guide setting wrong.	1. Perform Section 6.2, steps d, e, f and g.
4. Waving pattern in holes.	1. Tape Drive setting wrong.	1. Check registration alignment and perform Section 5.4 as required.
	2. Tape guide and/or edge guide setting wrong.	1. Perform Section 6.2, steps d, e, f and g.

Table 5-3. Troubleshooting Chart (Continued)

Indication	Probable Cause	Remedy
5. Tape tearing.	1. Tape drive adjustment not correct (too tight).	1. Check registration alignment and perform Section 5.4 as required.
6. Punch not moving tape.	1. Tape drive adjustment not correct (too loose).	1. Check registration alignment and perform Section 5.4 as required.
	2. Pin drive guide too tight (too close to pin drivers).	1. Perform Section 6.7, step g.
7. No holes or few holes being punched.	1. Punch block needs cleaning.	1. Clean punch block as described in Section 5.3.1.2.
	2. Punch pin depth improperly set.	1. Check punch pin depth as described in Section 5.5 and adjust as required.

SECTION VI

PARTS REPLACEMENT

6.1 GENERAL

REMEX maintains service facilities at its manufacturing location and at service centers in major population areas for repair or replacement of components for their products. It is recommended that one of these centers be contacted for assistance in case of equipment malfunction. For the location of service facilities in any area, contact REMEX at the address listed on the title page of the manual. Please direct inquiries to the attention of the Service Department. Always reference the complete model number and serial number when making inquiries.

When any parts require replacement, the procedures below should be followed closely. The warnings and cautions are included to protect personnel and equipment. Notes are included to assist persons unfamiliar with the equipment. Before attempting any procedure, all instructions for that disassembly should be read and understood.

Quantities of replaceable items suggested as spare parts are listed in Table 7-1. All replaceable items are identified in Section VII of this manual along with illustrations showing part locations.

6.2 TAPE GUIDE/EDGE GUIDE ASSEMBLY REPLACEMENT

The following procedure is recommended when replacing the tape guide and/or edge guide assembly. Letter designations in parenthesis refer to the hardware callouts in Figure 7-1.

- a. Remove the 2-56 socket head screw (H), lock and flat washer which hold the tape guide to the perforator housing.
- b. Remove the 4-40-1/4" binder head screws (J) which hold the two backing plates and edge guide assembly to the perforator housing. Screws labeled (J) in Figure 6-1 are the same as labeled (J) in Figure 7-1.
- c. Replacement is the reverse of steps a and b. Install but do not tighten screws.
- d. Insert tape gauge 400622-1 (8-track) or 400622-2 (6-track) so that the reference edge of the gauge is flush against the reference edge of the perforator housing. Refer to Figure 6-1.
- e. Position the edge guide squarely along the edge of the tape gauge so that the edges are parallel and the gauge just moves through without any play. Tighten the two screws (J).

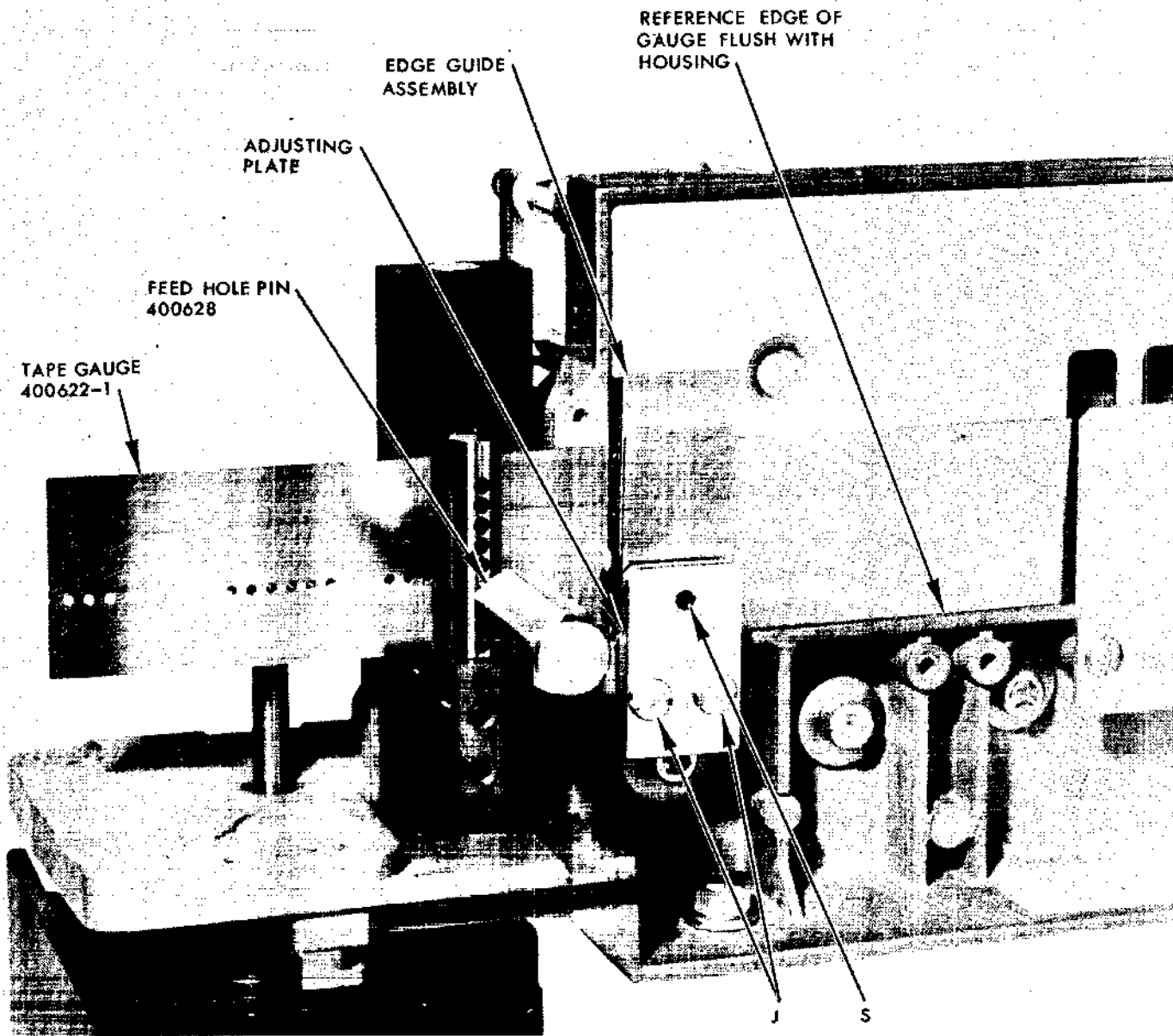

Figure 6-1. Tape Guide and Edge Guide Assembly Alignment.

- f. Position the tape guide squarely along the edge of the tape gauge so that the edges are parallel and the gauge just moves through without any play. Tighten the socket head screw (H). This step is omitted on newer units which do not contain the tape guide.
- g. Repeat steps d and e to make sure the tape gauge moves along the reference edge of the perforator freely but without any play between the edge guide and the tape guide.
- h. On units containing the adjusting plate, perform Section 5.6.

6.3 TAPE DRIVE ASSEMBLY REPLACEMENT

Before replacing the tape drive assembly 111591-1 it should definitely be established that the tape drive requires replacement and not just a registration alignment. See Section 5.4. The following procedure is recommended when replacing the tape drive assembly. Letter designations in parenthesis refer to hardware callouts in Figure 7-1.

- a. Remove the two 4-40 x 1-3/8" socket head screws (A) which hold the fixed tape guide to the drive assembly.
- b. Remove the three 4-40 x 1" socket head screws (B) which hold the tape drive assembly to the perforator housing.
- c. Install the new tape drive assembly but do not tighten the three screws (B).
- d. Perform Section 5.4, steps p through u.

6.4 STEP MOTOR ASSEMBLY OR SPROCKET REPLACEMENT

Before replacing the step motor assembly or sprocket, it should be definitely established that the motor assembly is defective and not the registration alignment drive motor circuits, motor damping or punch cycle time. The following procedure is recommended when replacing the step motor assembly or sprocket.

- a. Remove the two 4-40 x 1-3/8" socket head screws (A) flat and lock washers, which hold the fixed tape guide to the drive assembly.
- b. Remove the three 4-40 x 1" socket head screws (B) flat and lock washers, which hold the tape drive assembly to the perforator housing.
- c. Loosen the two set screws (C) which hold the sprocket to the motor shaft and move the sprocket in toward the motor.
- d. Remove the delrin disk. The delrin disk is press fit on the shaft but should slide off without using excess force.
- e. Remove the sprocket. If only the sprocket requires replacement, proceed to step l.
- f. Remove the cable clamp which clamps the cable between the motor and connector. Cut the spot ties in this same cable run.
- g. Unwind the Ty-Wrap in the same cable run.
- h. Using Molex Extractor tool HT2285 remove the motor wires from the connector. Note the location of the wires so the new motor wires are installed in the same location.

- i. Remove the screw (D) which clamps the heat sink to the motor and remove the heat sink. Note the orientation of the heat sink so that it is replaced in the same manner.
- j. Remove the three 4-40 screws (E) which hold the motor mounts to the perforator housing and remove the motor. Note the manner in which the motor wires are positioned so that the new motor is installed the same way.
- k. Install the new motor and motor mounts to the perforator housing by performing the reverse of step j. Install the motor wires in the connector.
- l. Install the sprocket but do not tighten the screws (C).
- m. Perform Section 5.4, steps e through u.
- n. Replace the cable wrap and remount the cable clamp. Do not overtighten cable clamp screw. When clamping the wires leave the red and black time elapse meter wires outside and dress them behind the clamp.
- o. Tywrap the motor wires to the heat sink screw and any other place where spot ties were cut in step f.

6.5 SOLENOID ASSEMBLY REPLACEMENT

It is recommended that the solenoid assembly 111726-3 (tracks 1-3 and feed hole) and 111726-4 (tracks 4-8) be replaced as a complete assembly. Before replacing the solenoid, it should be definitely established that the solenoid is defective and not the solenoid drive circuits or punch timing cycle. The following procedure is recommended when replacing a solenoid: Letter designations in parenthesis refer to hardware call-outs in Figure 7-1.

- a. Determine which solenoid is faulty. The solenoid corresponding to a particular track is shown in Figure 6-2.
- b. Remove all cable wrap from the solenoid to the connector.
- c. Remove the 2-56 x 1/4 screw which holds one of the clamps to the perforator housing depending upon which side of the punch the faulty solenoid is located.
- d. Remove the wires of the faulty solenoid from the connector with Molex extractor tool #HT-2285.
- e. Remove the 8-32 socket head screw and washer (G, Figure 7-1) which hold the solenoid to the perforator housing. These screws are located on the opposite side of the housing from the solenoids. Solenoids 4,5,6,7 and 8 require that the side plate be removed to gain access to these screws. Two screws and two washers (washers on under side of side plate) are used to hold the side plate to the perforator housing.
- f. Install the new solenoid by inserting the driver pin over the pin on the solenoid cam. Set the solenoid in place and replace screw (G) but do not tighten.

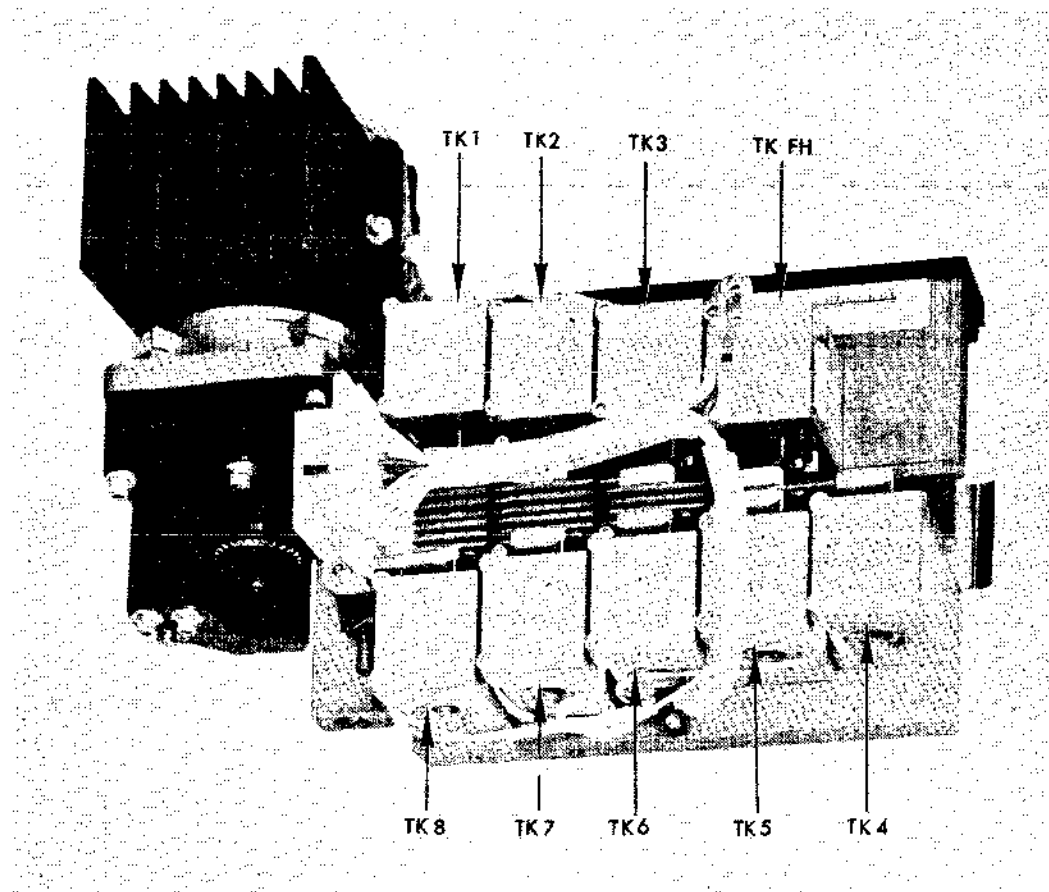

Figure 6-2. Solenoid Location For Each Track.

- g. Perform Section 5.5 for the track in which the solenoid was replaced.
- h. Insert the solenoid wire into the connector.
- i. Replace the cable wrap and clamp. Do not overtighten the cable clamp screw. When reinstalling the clamp on the elapse time indicator side of the perforator, leave the red and black time elapse meter wires outside and dress them behind the clamp.

6.6 PUNCH AND PIN BLOCK ASSEMBLY REPLACEMENT

It is recommended that the entire punch and pin block assembly be replaced as a complete unit. Before replacing the punch and pin block assembly, it should be definitely established that the punch and pin block is defective and not the solenoid, their drive circuits or the punch timing cycle. The following procedure is recommended when replacing a punch and pin block assembly. Letter designations in parenthesis refer to hardware callouts in Figure 7-1.

CAUTION

Use care not to drop or in any way remove the pins from the block. The pins are matched to each hole in the block and must not be interchanged.

- a. Remove the screw (F) which holds the chad tube to the punch and pin block assembly and remove the chad tube.
- b. Remove the two 6-32 x 1/2 socket head screws (K), lock and flat washers which hold the punch and pin block assembly to the perforator housing. Remove the old punch and pin block assembly.
- c. Pull the pins out of the new punch and pin block assembly only far enough to allow a shim to be inserted in to the tape path so that the punch pins do not fall out the chad side. Insert the shim.
- d. Push pins lightly in towards the shim.
- e. Align all pins so that they are perpendicular to the punch block. See Figure 6-3.
- f. Connect the pins to the pin drivers.
- g. Install the punch and pin block assembly to the perforator housing using the two screws (K) and new lock washers. REMEX recommends that new lock washers (P/N 713541-304) be used each time a punch block is installed. Do not tighten screws.
- h. Install REMEX tape gauge so that the reference edge of the gauge is flush against the reference edge of the perforator housing. Move the punch block as close to the housing as possible. Holding firmly on the gauge pull up on the punch block so that there is no gap between the reference edge of the punch block and the gauge. Refer to Figure 6-4. Tighten the two screws (K). Use a torque wrench and set the screws to 20 in/lbs.
- i. Lubricate the punch and pin block assembly as described in Figure 5-1.
- j. Perform Section 5.5.
- k. Perform Section 5.4, steps r, s, t and u.

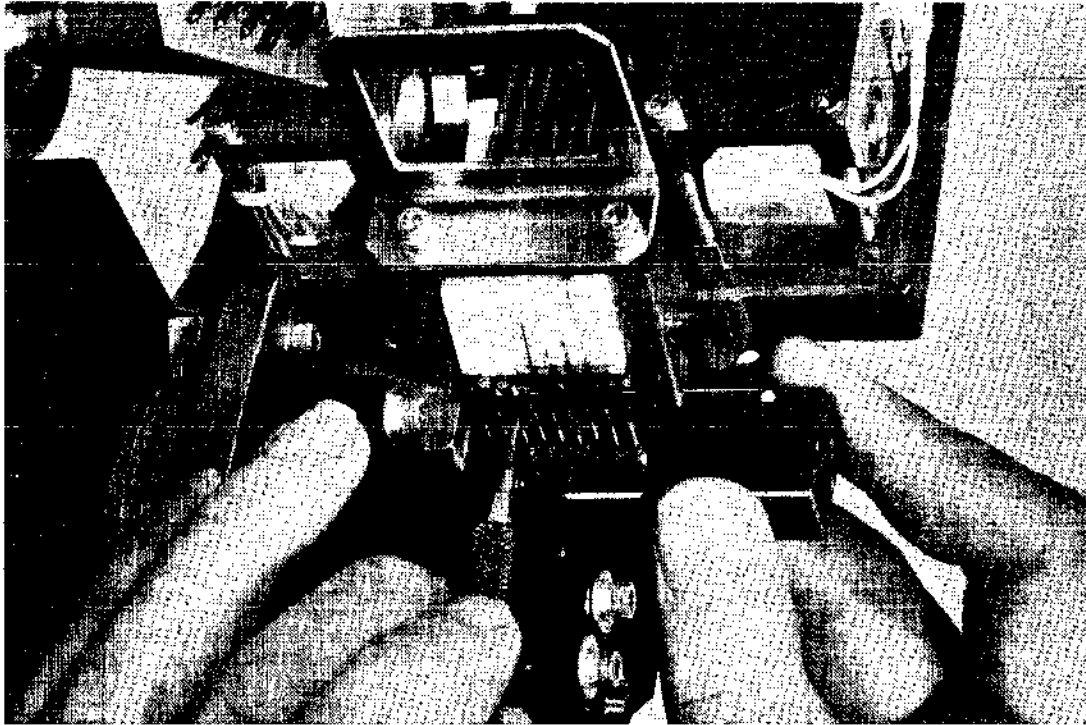

Figure 6-3. Punch Pin Alignment and Insertion into Pin Driver.

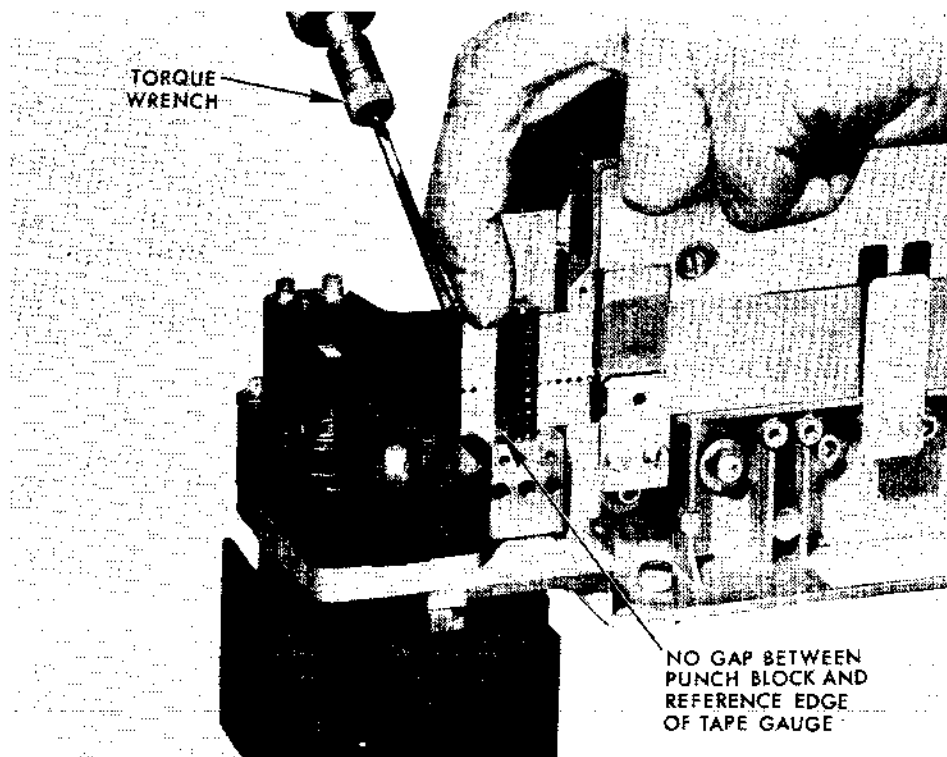

Figure 6-4. Installation of Punch and Pin Block Assembly.

The following procedure is recommended when replacing a pin driver. Letter designation in parenthesis refer to hardware callouts in Figure 7-1.

- a. Remove the two 4-40 binder head screws (L) which hold the support bracket, support bar and connector to the perforator housing. Earlier units have two 0.005 shims on each side installed between the support bar and perforator housing. Care should be used not to lose these shims. Note the order of assembly for correct replacement. Screws labeled (L) in Figure 6-5 are the same screws labeled (L) in Figure 7-1.
- b. In the hole from which the screws in step a were removed, loosen the two set screws (M) which hold driver pin in place. Remove the pin.
- c. Remove the 8-32 socket head screw (G) and washer of the solenoid associated with the pin driver to be remove. This screw is located on the opposite side of the housing from the solenoids. Solenoids 4, 5, 6, 7 and 8 require that the side plate be removed to gain access to the screw (G). Two screws (N) and two washers (washers on under side of plate) are used to hold the side plate to the perforator housing.
- d. Remove screws (P) which hold the pin driver guides to the perforator housing. Remove as many guides as required to replace the pin driver. Note that these screws have had screw lock applied and may be somewhat difficult to loosen. When replacing these screws add a new application of screw lock.
- e. Replace the pin driver by lifting the old one out and sliding the new one in place. Slide the solenoid in place and connect the pin driver to the pin on the solenoid.
- f. Perform the reverse of step d, c, b, and then a. When installing the support bar and support bracket, make sure the two 0.005 shims (if present) are installed under the support bar. Use a feeler gauge to obtain a 0.015 gap between the support bar and the top of the driver pins. Refer to Figure 6-5.
- g. Perform Section 5.5.

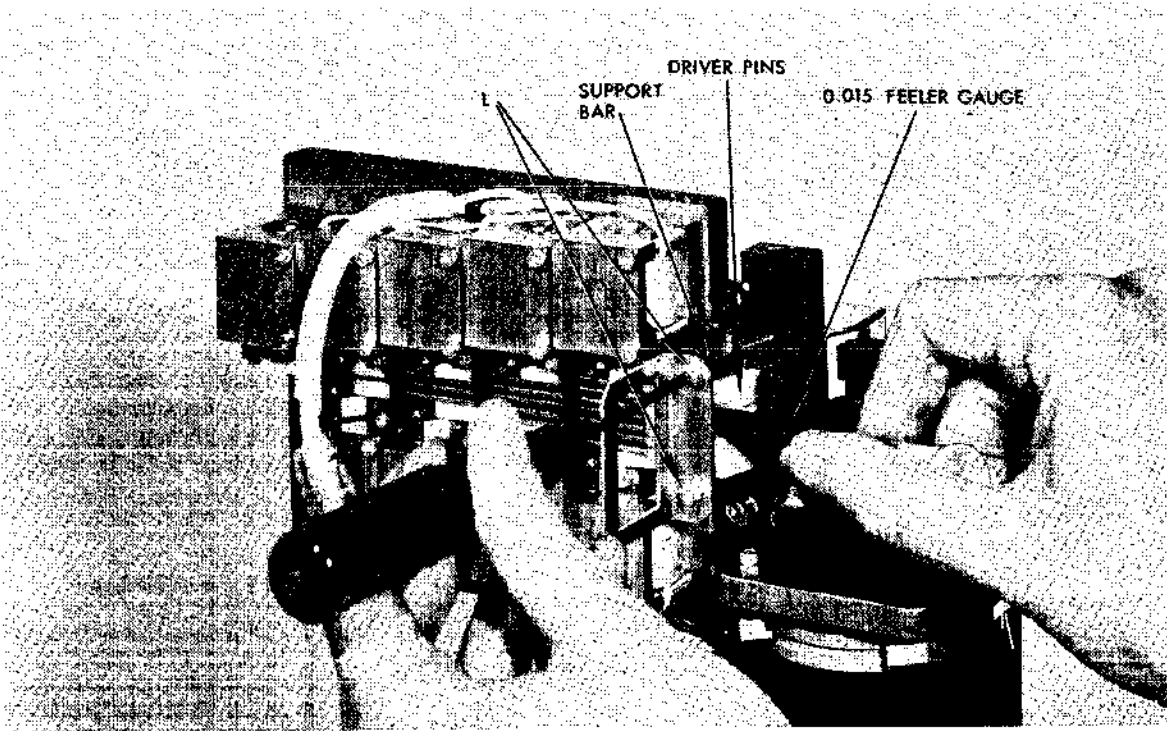

Figure 6-5. Adjustment of Support Bar and Support Bracket.

SECTION VII

PARTS LIST

7.1 GENERAL

Table 7-2 lists the major assemblies used on the RPM612XBAX. It is not recommended that parts below this level be replaced as individual items. Table 7-1 lists the recommended spare parts. Figure 7-1 shows an exploded view of the perforator. Only hardware items recommended for replacement in the disassembly procedures are listed. An X in a particular model number digit designator denotes any of the combinations given in Figure 1-4 for that designator is applicable. Maintenance equipment required is listed in Table 5-1.

All parts are available from REMEX Spares Order Desk, 1733 Alton Street, P. O. Box C19533, Irvine, California 92713.

7.2 KIT OF PARTS

The kit of parts contains items used for installation and maintenance and is shipped with the RPM612XBAB and are listed in Table 1-2, Equipment Supplied.

Table 7-1. Recommended Spare Parts

Description and Manufacturer's Part No.	REMEX Part No.	Recom. Quantity
Punch and Pin Block Assembly, RPM6121BAA	111546-2	1
Punch and Pin Block Assembly, RPM6122BAX	111549-1	1
Punch and Pin Block Assembly, RPM6123BAX	111545-1	1
Punch and Pin Block Assembly, RPM6124BAX	111547-1	1
Solenoid Assembly, Channels 1, 2, 3 and feedhole	111726-3	1
Solenoid Assembly, Channels 4, 5, 6, 7 and 8	111726-4	1
Fuse 2A, GMW-2 RPM612XBAB only	705725-110	3

NOTE: WHEN ORDERING SPARE PARTS, CONTACT REMEX SPARES ORDER DESK AND REFERENCE COMPLETE MODEL AND SERIAL NUMBER OF UNIT. ALWAYS REFER TO ADDENDUM AT THE REAR OF THE MANUAL (IF APPLICABLE) FOR POSSIBLE PART NUMBER CHANGES.

Table 7-2. Parts List RPM612XBAX

Description and Manufacturer's Part No.	REMEX Part No.	Quantity	Reference Designation
RPM6121BAA	111730-001	1	Ref.
RPM6121BAA (used in fanfold systems)	111730-003	1	Ref.
RPM6122BAA	111730-002	1	Ref.
RPM6121BAB	111730-011	1	Ref.
RPM6122BAB	111730-012	1	Ref.
RPM6123BAA	111975-001	1	Ref.
RPM6123BAB	111975-011	1	Ref.
RPM6124BAA	111975-002	1	Ref.
RPM6124BAB	111975-012	1	Ref.
The subassemblies for the above units are identical except as specifically noted. Refer to Figure 7-1 for part location.			
Access Tube, Chad, RPM612XBAB	113313-1	1	7-1, 1
Bracket, Fuse Card, RPM612XBAB	112590-1	1	7-1, 2
Bracket, Support	112144-1	1	7-1, 3
Bracket, Connector	111594-1	1	7-1, 4
① Chad Tube Assembly, RPM612XBAA	113458-1 ①	1	7-1, 42
Clamp, Cable, Weckesser 3/16-J	715040-148	2	7-1, 5
Clamp, Motor Mount	715076-116	3	7-1, 6
Connector, Housing, 24 Pin Molex P(03-06-2241)	706500-268	1	7-1, 7
Cover, Guide	111694-1	1	7-1, 8
Cover, Guide	111694-2	1	7-1, 9
Cover, Guide	111694-3	1	7-1, 10
Deflector Spring, Tape	111733-1	1	7-1, 11
Disc	111736-1	1	7-1, 12
Edge Guide Assembly	111729-1	1	7-1, 13
Guide, Pin Driver	111647-1	1	7-1, 14
Guide, Pin Driver	111647-2	1	7-1, 15
Guide, Pin Driver	111647-3	1	7-1, 16
Heat Sink	111737-1	1	7-1, 17
Housing, Perforator	111480-2	1	7-1, 18
Kit of Parts, RPM612XBAB	111992-1	1	
Meter Assembly, Elapse Time(Deleted on later units)	112001-1	1	7-1, 19
Motor Assembly, Stepper	111805-1	1	7-1, 20
Pin, 1/8" Standard Dowel, 4" long	713660-113	1	7-1, 21
Pin, Driver, Channels 2 and 7 ②	111417-1	2, (1)	7-1, 22
Pin Driver, Channels 3 and 6	111417-2	2	7-1, 23
Pin Driver, Channels 5 and Feedhole	111417-3	2	7-1, 24
Pin Driver, Channel 4	111417-4	1	7-1, 25
Pin Driver, Channel 1 and 8 ②	111418-1	2, 1	7-1, 26

① Refer to page 7-4 for change information notice.

② Channels 7 and 8 are not used on Models RPM6123BAX and RPM6124BAX.

NOTE: WHEN ORDERING SPARE PARTS, CONTACT REMEX SPARES ORDER DESK AND REFERENCE COMPLETE MODEL AND SERIAL NUMBER OF UNIT. ALWAYS REFER TO ADDENDUM AT THE REAR OF THE MANUAL (IF APPLICABLE) FOR POSSIBLE PART NUMBER CHANGES.

Table 7-2. Parts List RPM612XBAX (Continued)

Description and Manufacturer's Part No.	REMEX Part No.	Quantity	Reference Designation
① Plate, Adjusting	113357-1	1	7-1, 40
Plate, Backing Edge Guide	111734-1	2	7-1, 27
① Plate, Backing Spring	111731-1	1	7-1, 28
① Plate, Side, Perforator	①	1	7-1, 29
Printed Circuit Card, Fuse, RPM6121BAB and RPM6122BAB only	112581-1	1	7-1, 30
Fuse, 2A, GMW-2	705725-110	9	7-1, F1-F9
Printed Circuit Card, Fuse, RPM6123B4B and RPM6124B4B only	112581-2	1	7-1, 30
Fuse, 2A, GMW-2	705725-110	7	7-1, F1-F7
Punch and Pin Block Assembly, RPM6121BAA (used in fanfold systems only)	111546-2	1	7-1, 31
Punch and Pin Block Assembly, RPM6122BAX	111549-1	1	7-1, 31
Punch and Pin Block Assembly, RPM6123BAX	111545-1	1	7-1, 31
Punch and Pin Block Assembly, RPM6124BAX	111547-1	1	7-1, 31
Solenoid Assembly, Channels 1, 2, 3 and Feedhole	111726-3	4	7-1, 32
② Solenoid Assembly, Channels 4, 5, 6, 7 and 8	111726-4	5 (3)	7-1, 33
Spacer, Pin Driver, Model RPM6123BAX and RPM6124BAX only.	110425-1	1	7-1, 34
Sprocket, REMEX Specification	716057-103	1	7-1, 35
Support Bar, Pin Driver	112537-1	1	7-1, 36
① Tape Guide	111807-1	2	7-1, 37
① Tape Guide, Rear	113407-1	1	7-1, 41
Tape Drive Assembly	111591-1	1	7-1, 38
Tape Guide, Fixed	111581-1	1	7-1, 39
③ Screw (Sprocket) 4-40x1/8"	713000-121	2	7-1, C
③ Lock Washer (Punch and Pin Block Assembly) #6	713541-304	2	7-1, R

① Refer to page 7-4 for change information notice.

② Channels 7 and 8 are not applicable on Models RPM613BAX and RPM6124BAX.

③ These are the only hardware items in which replacement is required.

NOTE: WHEN ORDERING SPARE PARTS, CONTACT REMEX SPARES ORDER DESK AND REFERENCE COMPLETE MODEL AND SERIAL NUMBER OF UNIT. ALWAYS REFER TO ADDENDUM AT THE REAR OF THE MANUAL (IF APPLICABLE) FOR POSSIBLE PART NUMBER CHANGES.

CHANGE INFORMATION NOTICE

Description and Manufacturer's Part No.	REMEX Part No.	Quantity	Reference Designation
<p>1. Later model units delete tape guide 111807-1 (item 37, Figure 7-1) and add a tape guide rear 113407-1 (item 41, Figure 7-1). On these units, the side plate (item 29, Figure 7-1) changes from 111478-1 to 111478-2. Also newer units omit the top backing plate (item 27, Figure 7-1) from the edge guide assembly and replace it with Adjusting Plate (item 40, Figure 7-1).</p> <p>2. Later model units use a Chad Tube Assembly (item 42, Figure 7-1) instead of just a Chad Access Tube (RPM612XBAA units only). When reordering a Chad Access Tube on older units, order a Chad Tube Retrofit Kit 113459-1. RPM612XBAB units still use Chad Access Tube 113313-1 which has been modified from older part 111740-1. Order 1133131-1 for replacement.</p>			

SECTION VIII

SCHEMATIC

8.1 GENERAL

Figure 8-1 gives the schematic for the RPM612XBAB. The schematic for the RPM612XBAA and other units used in systems is contained on the schematic for that system as well as other important information concerning its installation, interface connection and operation.

Ex-Cell-O Corporation

REMEX DIVISION