

TEAC

FD-55A

FD-55B

FD-55E

FD-55F

FD-55G

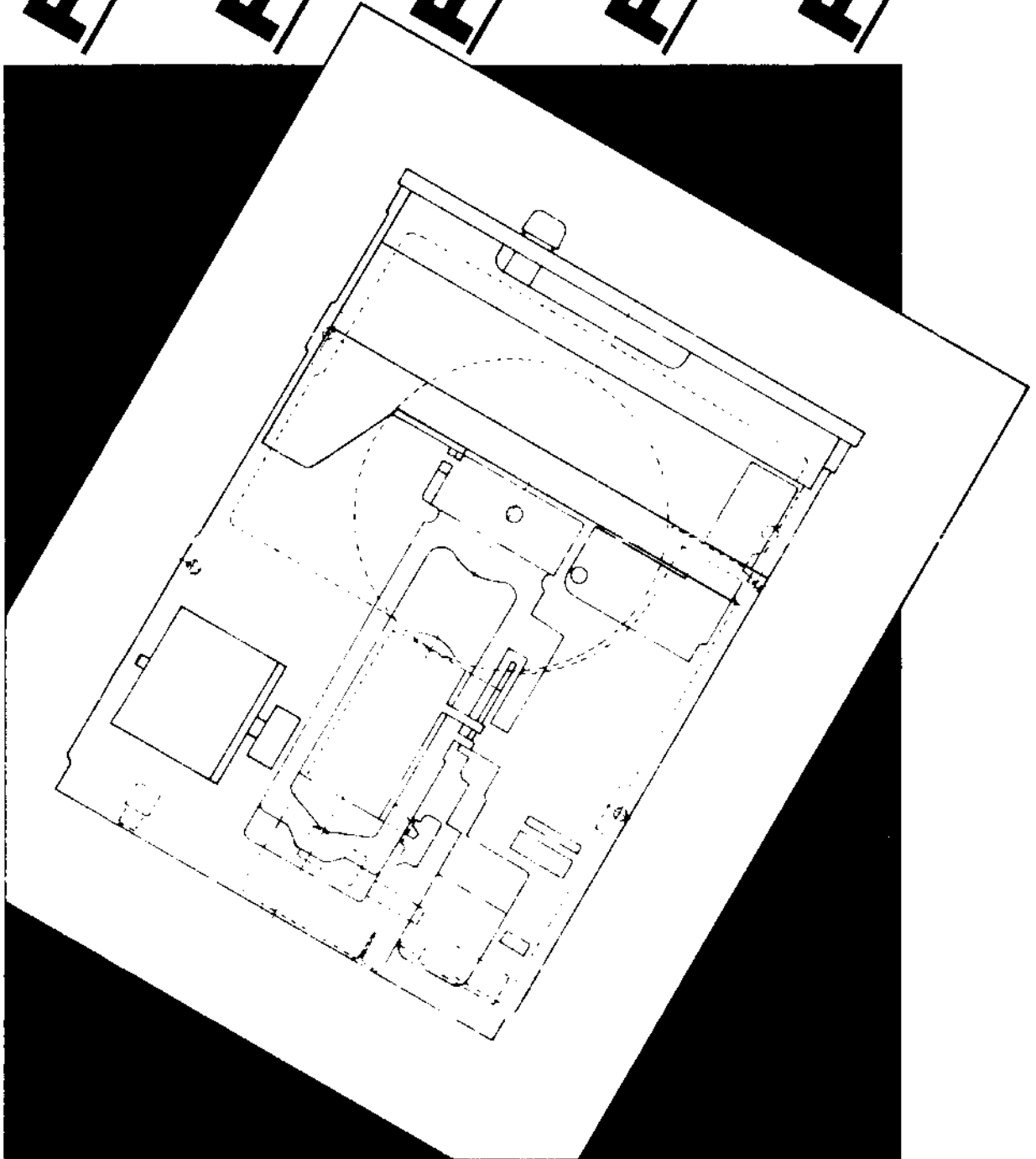

MINI FLEXIBLE DISK DRIVE SPECIFICATION

SPECIFICATIONS FOR FD-55A, FD-55B, FD-55E, FD-55F, FD-55G.

Recording Method: FM (single density), MFM (double density)

Motor Starting: 400 ms

Index: 1

MTBF: more than 10,000 hours

Error Rates

Soft Errors: 1 per 10^9 bits (up to 2 retries)

Hard Errors: 1 per 10^{12} bits

Seek Errors: 1 per 10^6 seeks

Temperature

Operating: 4° — 46°C

Transportation: 40° — 65°C

Storage: 22° — 60°C

Relative Humidity

Operating: 20 — 80% (noncondensing). Max. Wet Bulb Temperature: 29°C

Transportation: 5 — 95% (noncondensing). Max. Wet Bulb Temperature: 45°C

Storage: 10 — 90% (noncondensing). Max. Wet Bulb Temperature: 40°C

Power Requirements: DC + 12 V ± 5% 0.25 A typ., 0.9 A max., DC + 5V ± 5% 0.38 A typ., 0.6 A max.

Power Consumption

Operating: 4.9 W

Non-Operating: 1.6W

Dimensions

(W x H x D): 146 x 41 x 203 mm, (5-3/4" x 1-5/8" x 8")

Weight: less than 1.5 kg (3 lbs. 5 oz.)

Component Life: 5 years

Standard Safety: UL and CSA Recognized.

			FD-55A		FD-55B		FD-55E		FD-55F		FD-55G	
			FM	MFM	FM	MFM	FM	MFM	FM	MFM	FM	MFM
Transfer Rate (K bits/sec)			125	250	125	250	125	250	125	250	250	500
Capacity (K bytes)	Unformatted	Per Track	3.125	6.25	3.125	6.25	3.125	6.25	3.125	6.25	5.028	10.416
		Per Disk	125	250	250	500	250	500	500	1,000	802	1,604
	Formatted (16 sectors/ track)*	Per Sector	0.128	0.256	0.128	0.256	0.128	0.256	0.128	0.256	0.256	0.512
		Per Track	2.048	4.096	2.048	4.096	2.048	4.096	2.048	4.098	3.840	7.680
	Per Disk	81.92	163.84	163.84	327.68	163.84	327.68	327.68	655.36	591	1,183	
Inside Track Recording Density (bpi)			2768	5536	2938	5876	2788	5576	2961	5922	4823	9646
Inside Track Flux Density (frpi)			5536		5876		5576		5922		9646	
Tracks/Disk			40		80		80		160		154	
Track Density (tpi)			48				96					
Track Radius (mm)	Outside		57.150		side 0: 57.150 1: 55.033		57.150		side 0: 57.150 1: 55.033			
	Inside		36.513		side 0: 36.513 1: 34.396		36.248		side 0: 36.248 1: 34.131		side 0: 37.042 1: 34.925	
Average Access Time (ms)			93				94				91	
Track Access Time (ms)			6				3					
Settling Time (ms)							15					
Disk Rotational Speed (rpm)							300				360	

*FD-55G: 15 sectors/track

Features and specifications are subject to change without notice.

TABLE OF CONTENTS

	Title	Page
1-1	APPLICATION	101
1-2	DISK	101
1-3	PHYSICAL SPECIFICATION	101
1-4	REQUIRED POWER	104
1-5	ENVIRONMENTAL CONDITIONS	106
1-6	OPERATIONAL CHARACTERISTICS	107
1-7	RELIABILITY	110
1-8	SIGNAL INTERFACE	111
1-8-1	Electrical Characteristics	111
1-8-2	Signal Connector and Cable	113
1-8-3	Input/Output Signals	115
1-9	POWER INTERFACE	125
1-10	FRAME GROUNDING	127
1-11	INDICATOR AND STRAPS	128
1-11-1	HS-MX Straps	128
1-11-2	UR-RE Straps	130
1-11-3	PM Strap	131
1-11-4	Strap Setting at Shipment	131
1-12	SETTING OF OPERATIONAL CONDITION	132
1-12-1	Front Bezel Indicator	132
1-12-2	Spindle Motor	134
1-12-3	Head Load Solenoid	136

1-1. APPLICATION

This SPECIFICATION provides a description for the TEAC FD-55 family of LSI mini flexible disk drives (hereinafter referred to as the FDD). the FD-55G is equivalent to an 8 inch, double sided, double density FDD in various characteristics (i.e., data capacity, data transfer rate) except that it has the same interface as a standard mini FDD.

1-2 DOSL

5.25 inch, soft sectored flexible disks which comply with ISO, ANSI, or ECMA standard (Models A, B, E, and F).

5.25 inch, soft sectored high density flexible disks which are mutually agreed between the customer and TEAC (Model G).

1-3 PHYSICAL SPECIFICATION

- (1) Width: 146mm (5.75in), Nom.
- (2) Height: 41mm (1.63in), Non.
- (3) Depth: 203mm (7.99in), Nom. (excludes projections of interface connectors)
- (4) Weight: Less than 1.5Kg. (3.31 lbs.)
- (5) External view: See Fig. 101
- (6) Cooling Natural air cooling
- (7) Mounting: Mounting for the following directions are acceptable.
 - (a) Front loading, mounted vertically with front lever up.
 - (b) Front loading, mounted horizontally with indicator up. Do not mount horizontally with spindle motor up.
 - (c) Mounting angle in items (a) and (b) should be less than 30° (Models A & B) or 15° (Models E, F, and G) with front bezel up.

Note: As to the most appropriate mounting condition and mounting for other directions than the above will be considered separately.

- (8) Installation: With installation holes on the side frame or on the bottom frame of the FDD (See Fig. 101)
- (9) Material of frame: Aluminum diecast
- (10) Material of front vessel: PPHOX (Xyron) or ABS
Standard color: Black

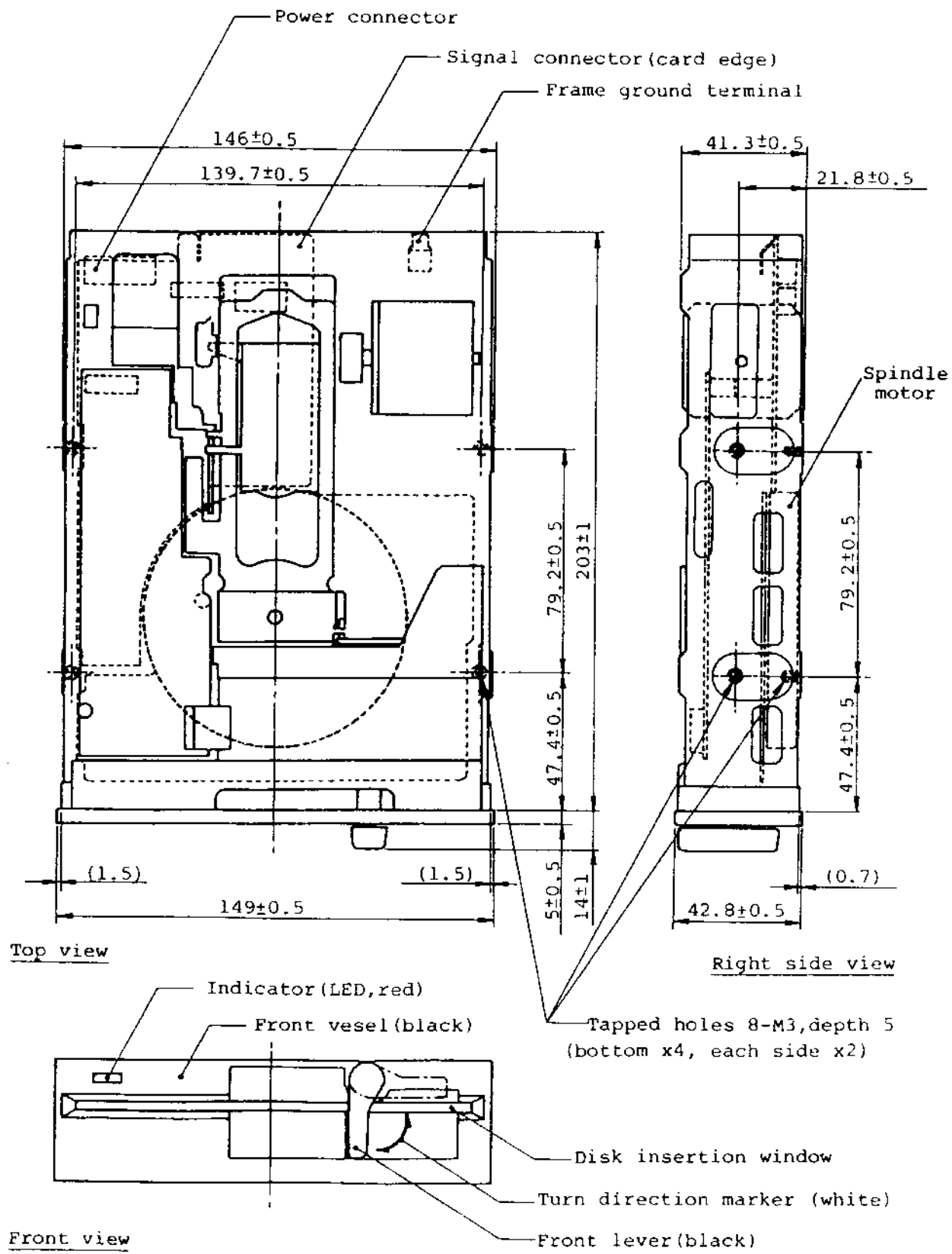

(Units:mm)

(Fig.101) External view

1-4. REQUIRED POWER

The following specifications are applicable at the power connector of the FDD.

(1) DC+12V

(a) Voltage tolerance

Read/write operation: Less than $\pm 5\%$

Others : Less than $\pm 10\%$

(b) Allowable ripple voltage: Less than 200mVp-p (including noise)

(c) Operating current consumption

Typical average: 0.25A

(using a disk of typical running torque)

Maximum average: Less than 0.6A

(using a disk of maximum running torque)

Peak: Less than 0.9A (400msec, Max. at spindle motor start)

(d) Waiting current consumption (spindle motor off)

Typical: 0.04A

Maximum: 0.07A

(2) DC+5V

(a) Voltage tolerance: $\pm 5\%$

(b) Allowable ripple voltage: Less than 100mVp-p (including noise)

(c) Operating current consumption

Typical average: 0.38A

Maximum average: Less than 0.5A

Peak: Less than 0.6A

(d) Waiting current consumption

Typical: 0.23A

Maximum: Less than 0.3A

(3) Power consumption

(a) Typical at operating: 4.9W

(b) Typical at waiting: 1.6W

(4) Power on sequence

Not specified. Since the FDD is equipped with a power reset circuit, disk and data on the disk will not be damaged by power on or off.

1-5. ENVIRONMENTAL CONDITIONS

- (1) Ambient temperature
 - (a) Operating: 4°C to 46°C (40°F to 115°F)
 - (b) Storage: -22°C to 60°C (-8°F to 140°F)
 - (c) Transportation: -40°C to 65°C (-40°F to 149°F)
- (2) Temperature gradient
 - (a) Operating: Less than 15°C (27°F) per hour
 - (b) Transportation and storage: Less than 30°C (54°F) per hour
- (3) Relative humidity
 - (a) Operating: 20% to 80% (no condensation)
Maximum wet bulb temperature: 29°C (84°F)
 - (b) Storage: 10% to 90% (no condensation)
Maximum wet bulb temperature: 40°C (104°F)
 - (c) Transportation: 5% to 95% (no condensation)
Maximum wet bulb temperature: 45°C (113°F)
- (4) Vibration
 - (a) Operating: Less than 0.5G (less than 55 Hz)
Less than 0.25 G (55 to 150 Hz)
 - (b) Transportation: Less than 2G (less than 100 Hz)
- (5) Shock
 - (a) Operating: Less than 10G (less than 10msec)
 - (b) Transportation: Less than 40G (less than 10msec)
- (6) Altitude
 - (a) Operating: Less than 5,000m (16,500 feet)
 - (b) Transportation: Less than 12,000m (40,000 feet)

Note: The above requirements are applied for the FDD without a shipping box. When a long period is required for transportation purposes (i.e. ship), the storage environmental conditions shall apply.

1-6. OPERATIONAL CHARACTERISTICS

(1) Disk rotation mechanism

- (a) Spindle motor: Direct DC brushless motor
- (b) Spindle motor speed: 300rpm (A, B, E, & F);
360rpm (G Model only)
- (c) Motor servo method: Frequency servo by AC tachometer
- (d) Motor/spindle connection: Motor shaft direct
- (e) Disk speed: 300rpm (A, B, E, & F); 360rpm (G Model only)
Long term speed variation (LSV): Less than $\pm 1.5\%$
Instantaneous speed variation (ISV): Less than $\pm 1.5\%$
- (f) Start time: Less than 400msec
- (g) Average latency: 100msec; 83.3msec (G model only)

(2) Index

- (a) Number of index: 1 per revolution
- (b) Detection method: LED and photo-transistor
- (c) Detection cycle: 200msec $\pm 1.5\%$; 166.7msec $\pm 1.5\%$ (G model only)
0 to 400usec, with specified test disk (A, B, E, & F).
0 to 330usec, with specified test disk (G model only).

(3) Track construction

(a) Positioning accuracy:

A & B model:

Less than $\pm 30\mu\text{m}$, with specified test disk. (Track 16,
 $23 \pm 2^\circ \text{C}$, 40 to 60% RH).

E, F, & G model:

Less than $\pm 20\mu\text{m}$, with specified test disk. (Track 32, 23
 $\pm 2^\circ \text{C}$, 40 to 60% RH).

	FD-55A	FD-55B	FD-55E	FD-55F	FD-55G
(4) Magnetic Head	Button type read/write head with tunnel erase	Gimball supported read/write head with tunnel erase, 2 sets	Button type read/write head with tunnel erase	Gimball supported read/write head with tunnel erase, 2 sets	
Read/Write Head Track Width	0.330mm (0.0130 inches), Nom.		0.16mm (0.0063 inches), Nom.	0.165mm (0.0065 inches), Nom.	
Effective Trace Width After Tunnel Erase	0.300 ± 0.025mm (0.0118 ± 0.0010 inches)		0.150 ± 0.015mm (0.0059 ± 0.0006 inches)	0.155 ± 0.015mm (0.0061 ± 0.0006 inches)	
Erase Head Track Width	0.17mm (0.0067 inches)		0.100mm (0.0039 inches), Nom.		
Read/Write-Erase Gap Spacing	0.85 ± 0.05mm (0.0335 ± 0.0020 inches)			0.585 ± 0.05mm (0.0335 ± 0.0020 inches)	
Read/Write Gap Azimuth	0 ± 18', with specified test disk				

- (5) Track seek mechanism
 - (a) Head positioning mechanism: Band positioner
 - (b) Stepping motor: 4-phase, 200 steps per revolution
 - (c) Stepping motor drive: 2 steps per track (A & B model); 1 step per track (E, F, and G model).
 - (d) Outermost and innermost stopper: Mechanical moving stopper of head carriage.
 - (e) Track 00 detection method: LED and photo-transistor
 - (f) Track to track time: Less than 6msec (A & B model); Less than 3msec (E, F, and G model)
 - (g) Settling time: Less than 15msec (excludes track to track time)
 - (h) Average track access time (includes settling time): 93msec (A & B model); 94msec (E & F model); 91msec (G model)
- (6) Head load mechanism
 - (a) Head load mechanism: Plunger solenoid
 - (b) Head load time: Less than 35msec
- (7) File protect mechanism: Detection of write enable notch by LED and photo-transistor.
- (8) Window margin (shipping): More than 600msec, with specified test disk, MFM method, PLO separator, and 0 write precompensation (A, B, E, and F model); more than 300msec with same parameters (G model)

1-7. RELIABILITY

- (1) MTBF: 10,000 power on hours or more (for typical usage)
- (2) MTRR: 30 minutes
- (3) Design component life: 5 years
- (4) Preventive maintenance: Not required (for typical usage)
- (5) Error rates:
 - (a) Soft read error: 1 per 10^9 bits (up to 2 retries)
 - (b) Hard read error: 1 per 10^{12} bits
 - (c) Seek error: 1 per 10^6 seeks
- (6) Security standard: UL and CSA recognized

1-8. SIGNAL INTERFACE

Four FDDs, Max. can be connected to one FDD controller by daisy chaining.

1-8-1. Electrical Characteristics

(1) Interface driver/receiver: See Fig. 102

(2) Electrical characteristics

The following specifications are applicable at the signal connector of the FDD.

(a) Input signal

LOW level (TRUE): 0V to 0.5V

Terminator current: 18mA, Max.

Receiver TTL current: 3.2mA, Max.

HIGH level(FALSE): 2.5V to 5.25V

(b) Output signal

LOW level (TRUE): 0V to 0.4V

Driver sink current capability: 48mA, Max.

HIGH level (FALSE): 5.25V, Max. (depending on controller terminator)

(3) Terminator

(a) Resistance value: 330ohm \pm 5%

(b) Terminator for DRIVE SELECT 0 to 3 input signals:

A terminator resistor is mounted on the PCB with soldering joint.

(c) Terminator for other input signals:

A resistor network is mounted on IC socket on the PCB.

(d) Shipping condition:

All of the terminator resistors are mounted.

(e) Multiplex connection:

For the multiplex connection of the FDDs by daisy chaining, the resistor network explained in item (c) shall be removed from all the FDDs except for the final FDD of the interface cable.

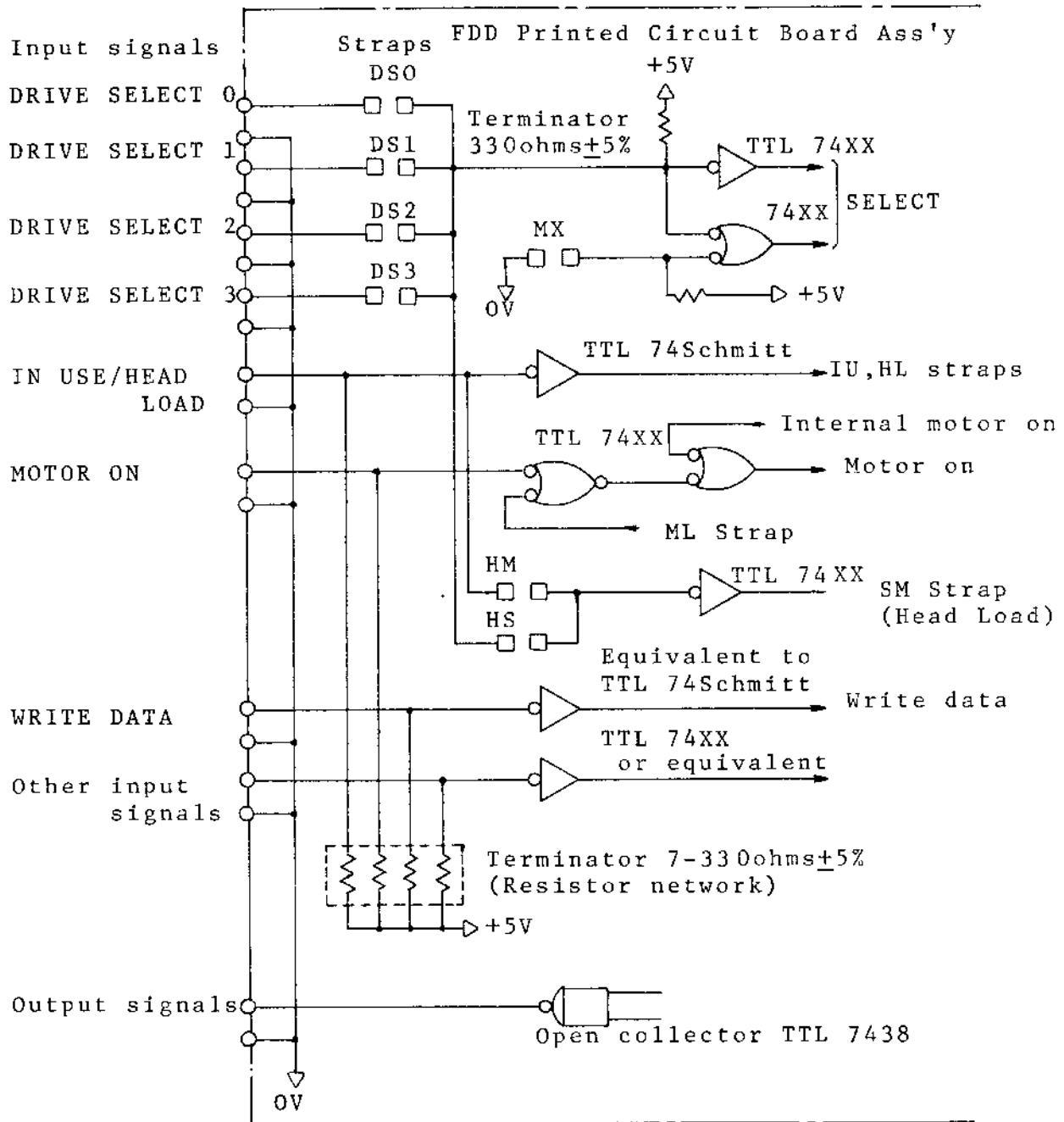

(Fig.102) Signal interface circuit

1-8-2. Signal Connector and Cable

(1) Signal connector

- (a) FDD side connector: Card edge (gold plated)
- (b) Pin numbers & pin pitch: 34 pins, 2.54mm (0.1 in) pitch
(17 pins on both sides, even number pins are bottom side of the FDD)
- (c) Polarizing key location: Between pins 4 and 6
- (d) Card edge dimensions: See Fig.103
- (e) Interface connections: See Table 102
- (f) Cable side matched connector: 3M, Scotchflex ribbon connector, P/N 3463-0001
or AMP, thin leaf connector, P/N 583717-5 and contactor P/N 1-583616-1
or equivalent

(2) Maximum interface cable length: 3m, Max.

For the multiplex connection by daisy chaining, the total cable length shall be less than 3m.

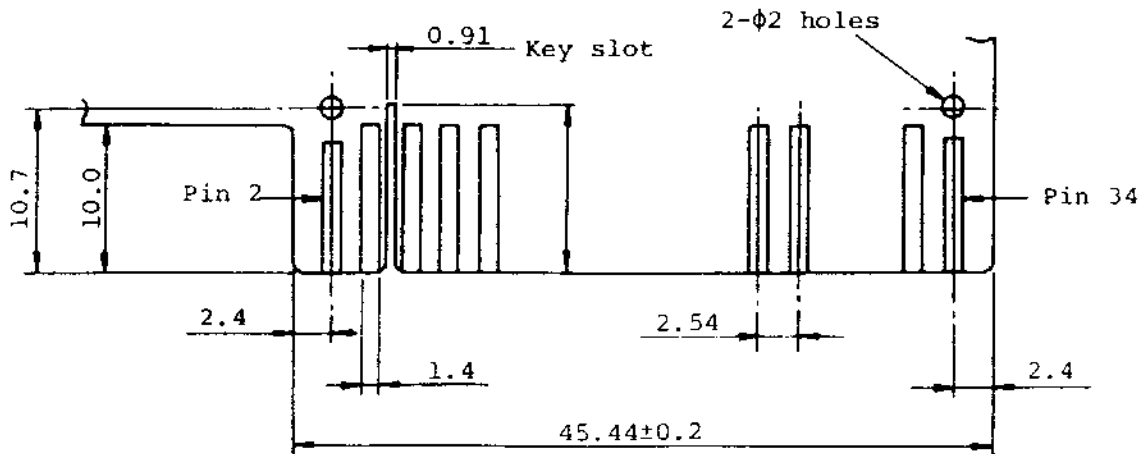

Notes: 1. PCB thickness: 1.6mm, Nom.

2. The figure shows bottom view of the FDD.

(Fig.103) Card edge dimensions of signal connector

Signals	Directions	Terminal Nos.	
		Signals	0V
SPARE	INPUT	2	1
IN USE/HEAD LOAD	INPUT	4	3
DRIVE SELECT 3	INPUT	6	5
INDEX/SECTOR	OUTPUT	8	7
DRIVE SELECT 0	INPUT	10	9
DRIVE SELECT 1	INPUT	12	11
DRIVE SELECT 2	INPUT	14	13
MOTOR ON	INPUT	16	15
DIRECTION SELECT	INPUT	18	17
STEP	INPUT	20	19
WRITE DATA	INPUT	22	21
WRITE GATE	INPUT	24	23
TRACK 00	OUTPUT	26	25
WRITE PROTECT	OUTPUT	28	27
READ DATA	OUTPUT	30	29
RESERVED	INPUT	32	31
READY	OUTPUT	34	33

Note: 1. SPARE terminal is open condition.

2. Since RESERVED terminal is used for SIDE ONE SELECT signal in double sided FDD, do not use the terminal for other purposes.

(Table 102) Signal interface connections

1-8-3. Input/Output Signals

Input signals are those transmitted to the FDD while output signals are those transmitted from the FDD.

Refer to item 1-12 as to the relation between input signals and the operating conditions of the front bezel indicator, spindle motor, or head load solenoid. LOW level of the signal is TRUE.

(1) DRIVE SELECT

- (a) Signals of four lines to select a specific FDD for operating in multiplex control by daisy chaining.
- (b) When the MX strap is off, only the DRIVE SELECT signal of the same number as of on-state strap among DSO to 3 straps is effective.
- (c) All the input signals except for the MOTOR ON and all the output signals can be effective when this signal is effectively received or when the MX strap is on.
- (d) The time required to make each input or output signal effective after the transmission of this signal is 0.5usec, Max. including delay time through the interface cable.
- (e) Refer to item 1-12 as to turn-on condition of the front bezel indicator and head load condition related to this signal.

(2) MOTOR ON input signal

- (a) Level signal to rotate the spindle motor.
- (b) The spindle motor reaches to the rated rotation speed within 400msec after this signal becomes TRUE.
- (c) Refer to item 1-12 as to rotating condition of the spindle motor by other input signals and head load condition related to this signal.

(3) DIRECTION SELECT input signal

- (a) Level signal to define the moving direction of the head when the STEP line is pulsed.
- (b) Step-out (moving away from the center of the disk) is defined as HIGH level of this signal. Conversely, step-in (moving toward the center of the disk) is defined as LOW level of this signal.

(4) STEP input signal

- (a) Pulse signal to move the head. The pulse width shall be more than 0.8usec and the head moves one track space per one pulse.
- (b) The access motion (head seek operation) is initiated at the trailing edge of the pulse and completes within 18msec (E, F, & G model) or 21msec (A & B model), after starting the access including the settling time. For the successive access motion in the same direction, the pulses shall be input with the spaces of more than 3msec (E, F, & G model) or 6msec (A & B model), while the pulses shall be input with the space of more than 18msec or 21msec for the access motion in a different direction.
- (c) This signal becomes ineffective when the WRITE PROTECT signal is FALSE and the WRITE GATE signal is TRUE.
Also this signal becomes ineffective when the TRACK 00 signal is TRUE and the DIRECTION SELECT signal is HIGH level (step-out).
- (d) This signal shall be input according to the timing in Fig. 104.

(5) WRITE GATE input signal

- (a) Level signal to erase the written data and to enable the writing of new data.
- (b) This signal becomes ineffective when the WRITE PROTECT signal is TRUE.
- (c) This signal shall be made TRUE after satisfying all of the following conditions.
 - i) More than 400msec after the start of the spindle motor or the FDD is in ready state (refer to item (13)).
 - ii) More than 35msec after the head loading is started.
 - iii) More than 18msec (E, F, & G model) or 21msec (A & B model) after the effective receipt of the final step pulse.
 - iv) More than 100usec after the level change of the SIDE ONE SELECT signal (E, F, & G model only).
- (d) None of the following operations shall be done for at least 590usec (G model only) or 1msec (A, B, E & F model only) after this signal is changed to FALSE.
 - i) Stop the spindle motor.
 - ii) Make the DRIVE SELECT signal FALSE.

- iii) Start the head access motion by the STEP pulse.
 - iv) Change the level of the SIDE ONE SELECT signal (B, F & G model only)
- (6) WRITE DATA output signal
 - (a) Pulse signal to designate the contents of the data to be written on the disk. The pulse width shall be 0.15usec through 1.1usec (G model only) or 0.15usec through 2.5 usec (A, B, E, & F model only), with the leading edge of the pulse being used.
 - (b) This signal becomes ineffective when one of the following conditions is satisfied.
 - i) WRITE GATE signal is FALSE.
 - ii) WRITE PROTECT signal is TRUE.
 - (c) This signal shall be input according to the timing in Fig. 105.
- (7) SIDE ONE SELECT input signal (double sided FDD; B, F & G model only)
 - (a) Level signal to define which side of a two-sided disk is used for reading or writing.
 - (b) When this signal is HIGH level, the magnetic head on the side 0 surface of the disk is selected, while the magnetic head on the side 1 surface is selected when this signal is LOW level.
 - (c) The READ DATA signal on a selected surface becomes valid more than 100usec after the change of this signal level.
 - (d) Write operation (the WRITE GATE signal TRUE) on a selected surface shall be started more than 100usec after the change of this signal level.
 - (e) When the other side of the disk is selected after the completion of a write operation, the level of this signal shall be switched more than 590usec (G model) or 1msec (B & F model), after making the WRITE GATE signal FALSE.
- (8) IN USE/HEAD LOAD input signal

This signal can either be used for the IN USE function or HEAD LOAD function by selecting either of the IU and HL straps (refer to item 1-11-2).

 - (a) When IN USE function is selected:
 - i) Level signal to indicate that the FDD is in use condition under the control of the host system.
 - ii) Refer to item 1-12-1 as to the turn-on condition of the front bezel indicator related to this signal.

(b) When HEAD LOAD function is selected:

i) Level signal to load the head.

ii) Head loading can be executed only when the FDD is in ready or pre-ready state.

Head loading will be settled within 35msec after the start of the head load operation, then data read or write operation can be executed if the FDD is in ready state. (Refer to item (13)).

iii) If the MX strap is on (applied to only one connection of the FDD), the head loading starts when this signal becomes TRUE.

iv) If the MX strap is off, the head loading starts when both of the DRIVE SELECT signal of the same number as of on-state strap among DSO to 3 and this signal becomes TRUE.

(9) TRACK 00 output signal

(a) Level signal which indicates that the head is on track 00 (the outermost track).

(b) This signal becomes valid more than 2.8msec (E, F & G model) or 5.8msec (A & B model), after the effective receipt of the STEP pulse.

(10) INDEX output signal

(a) Pulse signal for the detection of the index hole.

(b) This signal can be output in a correct timing more than 400msec after the start of the spindle motor.

(c) Fig. 106 shows the timing for this signal. Leading edge of the pulse shall be used as the reference.

(d) If the output condition in item (1) - (c) is satisfied when no disk is inserted, this signal maintains TRUE.

(11) READ DATA output

(a) Pulse signal for the read data from the disk composing clock and data bits together.

(b) Fig. 107 shows the timing for this signal. Leading edge of the pulse shall be used as the reference.

- (c) This signal becomes valid when all of the following five conditions are satisfied.
 - i) The FDD is in ready state (refer to item (13)).
 - ii) More than 35msec after the head loading is started.
 - iii) More than 18msec (E, F & G model) or 21msec (A & B model) after the effective receipt of the final STEP pulse.
 - iv) More than 590usec (G model) or 1msec (A, B, E & F model) after the WRITE GATE signal becomes FALSE.
 - v) More than 100usec after the level change of the SIDE ONE SELECT signal (B, F & G model only).
- (12) WRITE PROTECT output signal
 - (a) Level signal which indicates that the write enable notch of the disk is masked.
 - (b) When this signal is TRUE, the data on the disk is protected from erasing and the writing of new data is inhibited.

(13) READY output signal

(a) Level signal which indicates that the FDD is in ready state.

(b) The FDD becomes ready state when all of the following four conditions are satisfied.

i) The FDD is powered on.

ii) Disk is installed.

iii) The disk rotates at more than 50% of the rated speed.

iv) Two INDEX pulses have been counted after item iii) is satisfied.

Note: Pre-ready is the state that at least one INDEX pulse has been detected after item iii) is satisfied.

(c) Required time for this signal to become TRUE after the start of the spindle motor is less than 730msec (G model) or 800msec (A, B, E & F model). However, if the spindle motor reaches the rated rotational speed within 400msec after the start, then the READY signal becomes TRUE.

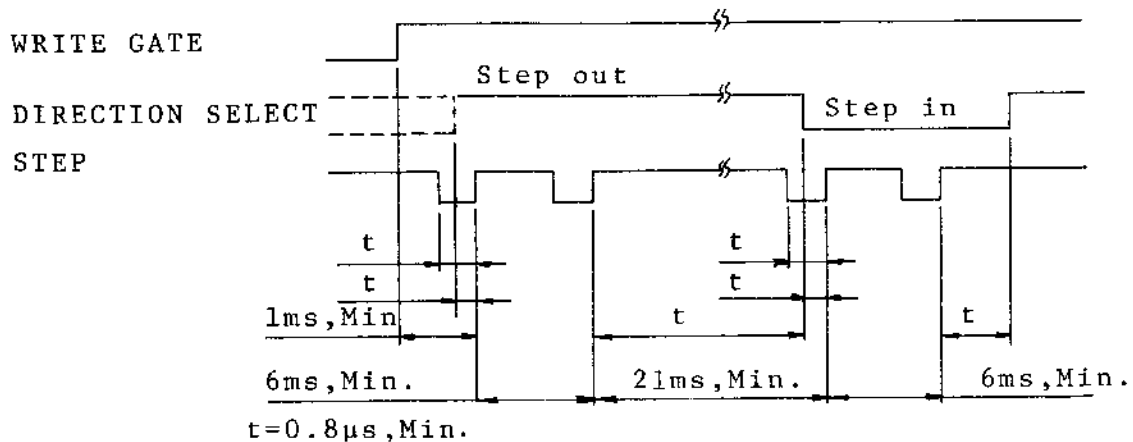

FD55A & FD55B

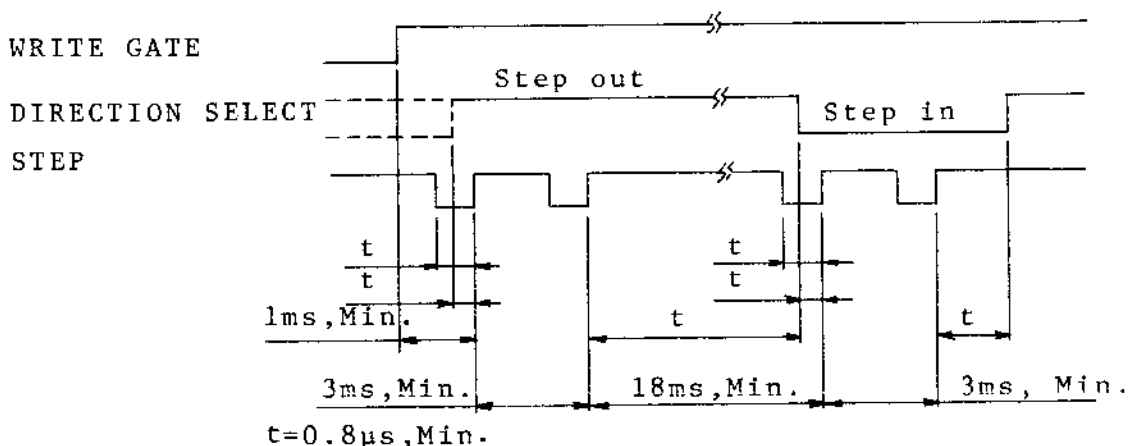

FD55E & FD55F

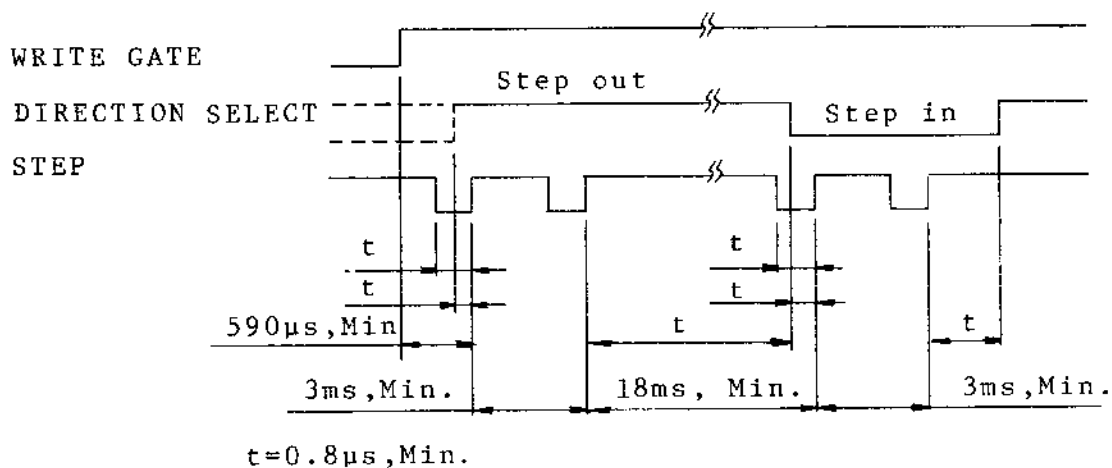

FD55G

(Fig.104) STEP timing

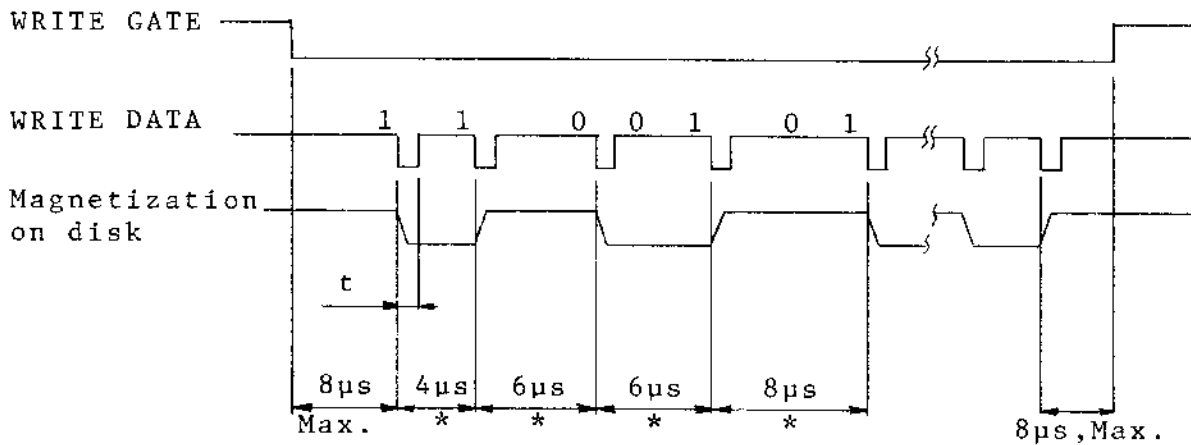

*: $\pm 0.5\%$ $t = 0.15 - 2.5 \mu s$

FD55A, FD55B, FD55E, and FD55F

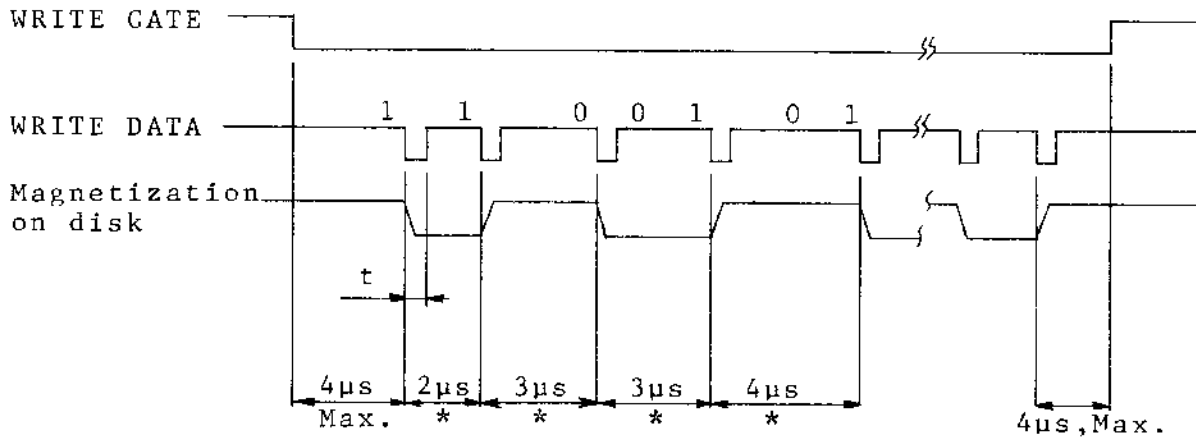

*: $\pm 0.5\%$ $t = 0.15 - 1.1 \mu s$

FD55G

(Fig.105) WRITE DATA timing (MFM method)

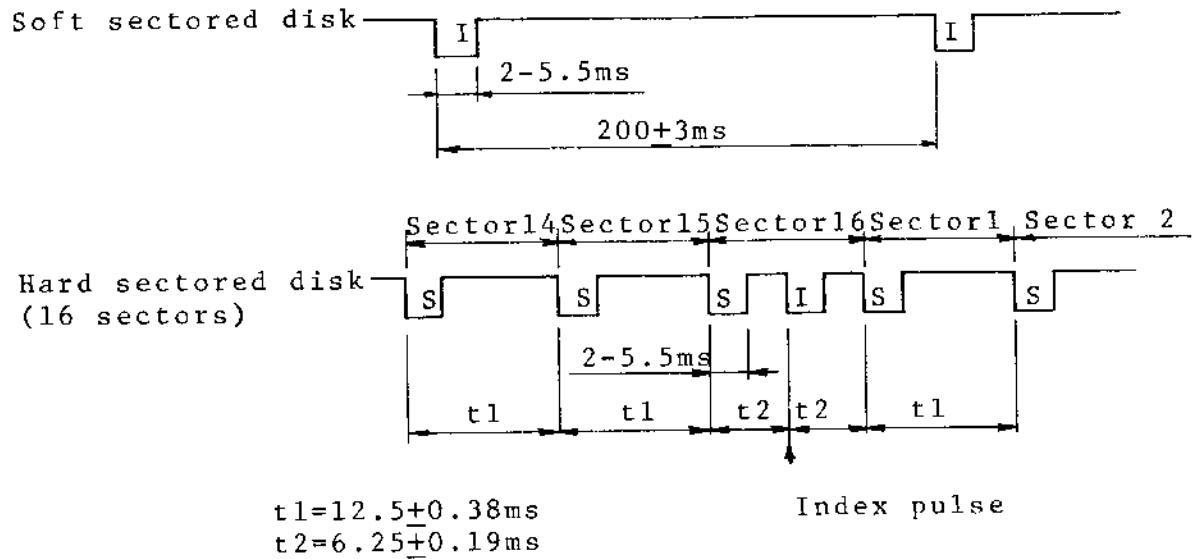

FD55A, FD55B, FD55E, AND FD55F

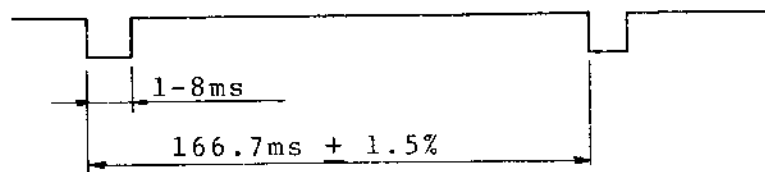

FD55G

(Fig.106) INDEX timing

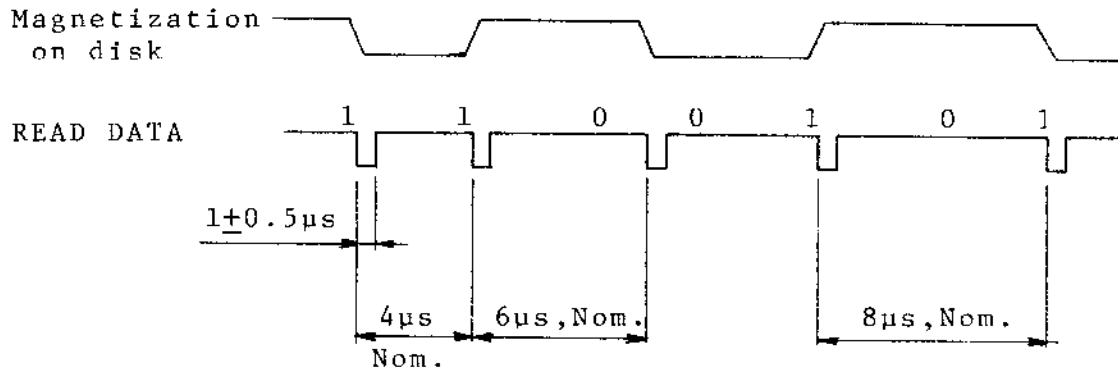

FD55A, FD55B, FD55E, AND FD55F

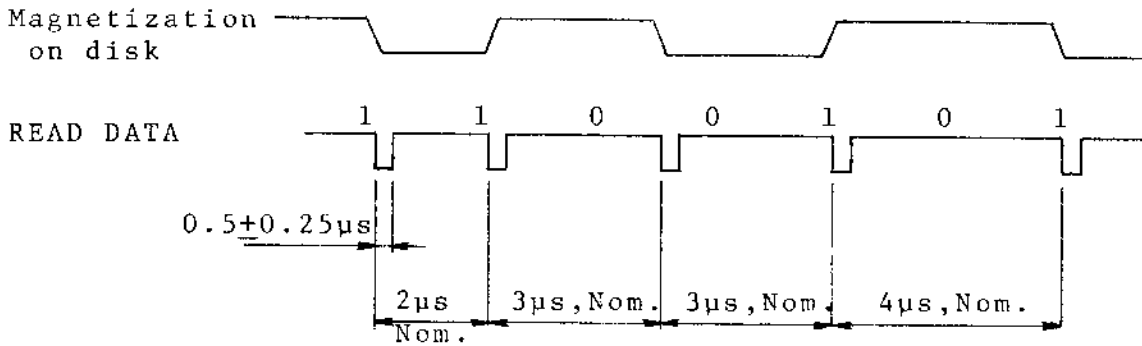

Note: The displacement of any bit position does not exceed $\pm 20\%$ from its nominal position.

FD55G

(Fig.107) READ DATA timing (MFM method)

1-9. POWER INTERFACE

Refer to item 1-4 for power requirements.

(1) Power connector

- (a) FDD side connector: AMP, Mate-N-Lock connector, P/N 172349-1
or equivalent
- (b) Pin numbers: 4 pins
- (c) Protection method for mis-connection: Mechanical protection by the
shape of the connector housing.
- (d) Pin location: See Fig.108
- (e) Power interface connections: See Table 103
- (f) Cable side matched connector: AMP, P/N 1-480424-0 and pins 60617-1,
or 60619-1,
or equivalent

(2) Power cable

Any appropriate cables taking the maximum power consumption of the FDD and the power voltage at the connector into consideration will be acceptable.

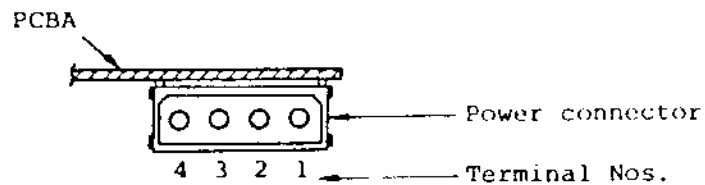

(Fig.108) Power connector pin location (Rear view)

Voltage	Terminal Nos.
DC+12V	1
0V	2
0V	3
DC+5V	4

(Table 103) Power interface connections

1-10. FRAME GROUNDING

(1) Frame grounding

- (a) Frame ground is AC coupled to DC 0V by $0.01\mu\text{F} // 100\text{K}\Omega$.
- (b) Insulation resistance is more than $80\text{K}\Omega$ at less than DC 150V.

(2) Frame ground terminal (back side of the FDD)

- (a) FDD side terminal: AMP Faston 187 tab P/N 61761-2
or equivalent
- (b) Cable side matched terminal: AMP P/N 60972-2 or 60920-1
or equivalent

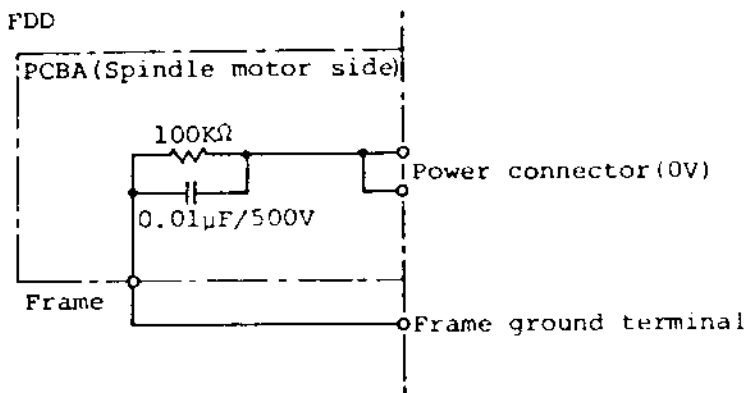

(Fig.109) Frame ground internal connection

1-11. STRAPS

All the straps are mounted on the PCB under the FDD (PCB to which the interface connector is connected). Insertion of a short bar onto the post pin of 0.64mm x 0.64mm (0.025 in) is defined as the on-state of the strap.

Fig. 110 shows the assignment of the straps on the PCB.

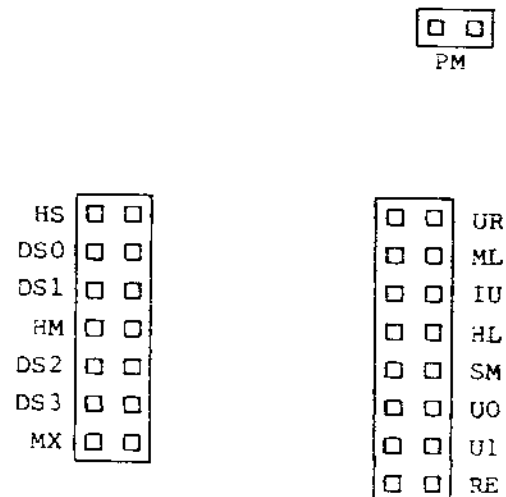

(Fig.110) Assignment of the straps

1-11-1. HS to MX Straps

(1) MX Strap

- The on-state of this strap is used only when one FDD is connected to the system. All the input/output signals can be effective at this time independently of the DRIVE SELECT 0 to 3 signals.
- At the off-state of this strap, 4 FDDs, Max. can be controlled by daisy chaining.
- This strap has no relation to the turn-on condition of the front bezel indicator and the rotating condition of the spindle motor.

(2) DSO to DS3 straps

- (a) In the multiplex control by daisy chaining, these straps designate the address of the FDD.
- (b) By the combination with the DRIVE SELECT 0 to 3 signals (refer to Fig. 102 and item 1-8-3 (1)), four addresses of 0 through 3 can be designated. Never designate more than 2 FDDs to a same address.
- (c) Refer to item 1-12 as to the relation between these straps (or the DRIVE SELECT signals) and the operating conditions of the front bezel indicator, spindle motor, or head load solenoid.

(3) HS and HM straps

- (a) Only when the SM strap in the UR to RE strap block is on-state, they become effective as the straps to determine the head load condition.
- (b) If the SM strap is off-state, both the HS and HM straps become ineffective.
- (c) Never set the HS and HM straps on at the same time.
- (d) If the HS strap is on effectively, head loading will be executed when the DRIVE SELECT signal selected by DSO to 3 straps is TRUE in ready or pre-ready state of the FDD. (Refer to item 1-8-3 (15)).
- (e) If the HM strap is on effectively, head loading will be executed by the MOTOR ON signal in ready or pre-ready state of the FDD.

1-11-2. UR to RE Straps

(1) IU and HL straps

- (a) Straps to select the function of IN USE/HEAD LOAD input signal (signal connector pin 4).
- (b) When the IU strap is on-state, the signal of pin 4 functions as the IN USE signal, while it functions as the HEAD LOAD signal when the HL strap is on-state. (Refer to item 1-8-3 (8)).
- (c) When both straps are off-state, the signal of pin 4 has neither of the functions. When both straps are on-state, the signal has two functions of IN USE and HEAD LOAD.

(2) SM strap

- (a) Strap to enable the HS and HM straps to determine the head load condition (refer to item 1-11-1 (3)). When this strap is on-state, the HS and HM straps become effective.
- (b) Three head load conditions can be selected with HS, HM, SM, and HL straps. Refer to item 1-12-3. All the strap combinations except for those in item 1-12-3 are not used practically.

(3) UO, UI, and UR straps

- (a) Straps to determine the turn-on condition of the front bezel indicator. Six turn-on conditions can be selected including the IU strap in item (1). Refer to item 1-12-1.
- (b) All the strap combinations except for those in item 1-12-1 are not used practically. Never set the UO and UR straps on at the same time.

(4) ML strap

- (a) Strap to determine the rotational condition of the spindle motor by an external command.
- (b) When this strap is off-state, the spindle motor rotates only by the MOTOR ON input signal.
- (c) When this strap is on-state, the spindle motor rotates by either of the following conditions. (Refer to item 1-12-2 (1)).
 - i) When the MOTOR ON input signal is TRUE.
 - ii) When the front bezel indicator turns on.

(5) RE strap (G model only)

- (a) For memorizing the track position of the head and automatic switching of the low-pass filter (in the read amplifier) at an appropriate track, this strap functions to recalibrate the head to track 00 automatically.
- (b) When this strap is off-state, the automatic recalibration will not be executed.
- (c) When this strap is on-state, the automatic recalibration will start at the first pre-ready state of the FDD (refer to item 1-8-3, (13)) after power on.

Automatic recalibration will complete within 255msec (when the head is on the innermost track) and the READY signal maintains FALSE during the recalibration.

- (d) The switching position of the low-pass filter is between track 43 and track 44.

1-11-3. PM Strap

- (a) Strap to make the spindle motor rotate automatically at the insertion of a disk.
- (b) When this strap is off-state, automatic rotation of the spindle motor will not be executed.
- (c) When this strap is on-state, automatic rotation of the spindle motor by the FDD internal circuit will be executed. (Refer to item 1-12-2 (2)).

1-11-4. Strap Setting of Unit at shipment

The FDD is shipped with the following straps set to on-state:
HS, DSO, IU, SM, and PM (A, B, E, and F models)
IIS, DSO, IU, SM, PM, and RE (G model only).

1-12. SETTING OF OPERATIONAL CONDITION

1-12-1. Front Bezel Indicator

Six turn-on conditions of the front bezel indicator are offered for selection using four straps IU, U0, U1, and UR as shown in Table 104.

Selection No.	Strap combinations				Indicator turn-on conditions
	IU	U0	U1	UR	
1	-	-	-	-	DRIVE SELECT
2	-	-	-	ON	DRIVE SELECT x Ready
3	ON	ON	-	-	IN USE
4	ON	ON	ON	-	IN USE latch
5	ON	-	-	-	DRIVE SELECT + IN USE
6	ON	-	ON	-	DRIVE SELECT + IN USE latch

- Notes: 1. "-" mark indicates the off-state of the strap;
2. Other combinations not specified in table are not used practically.
3. Never set U0 and UR straps on at the same time.

(Table 104) Indicator turn-on conditions

(1) Selection No. 1

While the DRIVE SELECT signal selected by DSO to 3 straps is TRUE, the indicator turns on.

(2) Selection No. 2

When the condition in item (1) is satisfied and the FDD is in ready state (refer to item 1-8-3(13)), the indicator turns on.

(3) Selection No. 3

While the IN USE signal (signal connector pin 4) is TRUE, the indicator turns on.

(4) Selection No. 4

- (a) While the IN USE flip-flop in the FDD is set, the indicator turns on.
- (b) If the IN USE signal (signal connector pin 4) is TRUE, the IN USE flip-flop is set by the leading edge of the DRIVE SELECT signal selected by DS0 to 3 straps.
- (c) If the IN USE signal is FALSE, the IN USE flip-flop is reset by the leading edge of the DRIVE SELECT signal selected by DS0 to 3 straps.

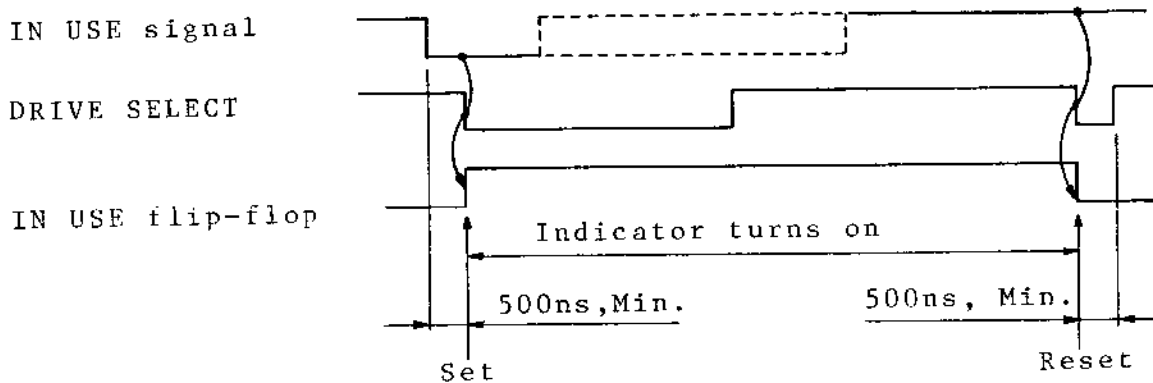

(Fig.111) IN USE signal latch

(5) Selection No. 5

The indicator turns on in the condition of item (1) or (3).

(6) Selection No. 6

The indicator turns on in the condition of item (1) or (4).

1-12-2. Spindle Motor

The spindle motor starts rotation in either of the following conditions (1) and (2).

The motor reaches to the rated rotational speed within 400msec after the start.

(1) Rotation by an external command to the FDD

Either of the following conditions is selected by the ML strap.

(a) Selection No.1 -- Off-state of ML strap:

The spindle motor rotates while the MOTOR ON signal is TRUE.

(b) Selection No.2 -- On-state of ML strap:

The spindle motor rotates while the MOTOR ON signal is TRUE, or while the front bezel indicator is on.

Note that "Selection No.2" of the front bezel indicator turn-on conditions (refer to item 1-12-1) is not applicable for this purpose.

(2) Automatic rotation by the internal circuit of the FDD

Either of the following conditions is selected by the PM strap.

(a) Selection No.1 -- Off-state of PM strap:

No automatic rotation by the internal circuit is executed.

(b) Selection No.2 -- On-state of PM strap:

Automatic rotation by the internal circuit will start under either of the following conditions i) and ii).

i) When a disk is inserted into the front bezel.

ii) When the disk is removed.

Note that the automatic rotation will not start when a write protected disk is removed.

Automatic rotation will stop under either of the following conditions
iii) and iv).

- iii) When the front lever is closed, disk starts rotation, and the FDD becomes ready state. The READY signal maintains FALSE.
- iv) Approximately 10 seconds after the removal of a disk from the FDD. Or in a rare case, when a disk is inserted at the index hole position and the front lever is not closed for 10 seconds, approx.

1-12-3. Head Load Solenoid

Three head load conditions are offered for selection using four straps HL, SM, HS, and HM as shown in Table 105.

Selection No.	Strap combinations				Head load conditions
	HL	SM	HS	HM	
1	-	ON	-	ON	Ready + pre-ready
2	-	ON	ON	-	(DRIVE SELECT + MX)x(Ready + Pre-ready)
3	ON	-	-	-	(DRIVE SELECT + MX)x(Ready + Pre-ready) x HEAD LOAD

- Notes: 1. "-" mark indicates the off-state of the strap.
 2. Other combinations not specified in table are not used.
 3. Never set HS and HM straps on at the same time.

(Table 105) Head load condition

Head loading will be settled within 35mscc after the start of the head load operation, then data read or write operation can be executed if the FDD is in ready state. (Refer to item 1-8-3, (13)).

(1) Selection No. 1

Head loading is executed while the FDD is in ready or pre-ready state (refer to item 1-8-3 (13)) by an external spindle motor rotation command (refer to item 1-12-2 (1)).

(2) Selection No. 2

Head loading is executed while the condition of item (1) is satisfied, and while the MX strap is on-state or the DRIVE SELECT signal selected by DSO to 3 straps is TRUE.

(3) Selection No. 3

Head loading is executed while the conditions of items (1) and (2) are satisfied and while the HEAD LOAD signal (signal connector pin 4) is TRUE.

