

# **Qume** **Manual**

**Memory Products**  
**DataTrak 8**  
**Product Specifications**

April 1979



**Reorder Number 30006**

Reprinted January 1980.

© 1979 Qume Corporation

Qume, Qume Caribe Inc., Q, Q30, Q45, Sprint, Sprint 45, Sprint 55, Sprint 3, Sprint Micro 3, Sprint Micro 3/35, Sprint Micro 3/45, Sprint Micro 3/55, Sprint 5, Sprint Micro 5/45, Sprint Micro 5/55, WideTrack, TwinTrack, PHD, SpeedFeed, Twintellect, Wedge, Activity Monitor, MultiColor, DataTrak, DataTrak 5, DataTrak 8, and QPW are Trademarks or Registered Trademarks of Qume Corporation.

## TABLE OF CONTENTS

	PAGE
<b>GENERAL</b>	1
SPECIFICATION SUMMARY	1
INSTALLATION REQUIREMENTS	2
RELIABILITY AND MAINTENANCE	3
MOUNTING	3
Mechanical Dimensions	3
Recommendations	3
IBM COMPATABILITY	3
TRACK POSITIONING	3
READ/WRITE/ERASE HEAD	3
Read Output Level	3
Write Current	3
INDEX POSITIONING	4
<b>ELECTRICAL INTERFACE</b>	4
SIGNAL INTERFACE	4
OUTPUT LINES	4
INPUT LINES	4
Drive Select 1-4	4
Direction	4
Step	4
Write Data	7
Write Gate	7
Head Select	7
Low Current	7
Head Load	7
In Use	7
Index	7
Ready	7
Track 00	7
Write Protect	7
Read Data	7
Disk Change	7
Disk 2 Sense	7
ALTERNATE I/O PINS	8

## TABLE OF CONTENTS (continued)

	PAGE
<b>CUSTOMER STRAPPABLE OPTIONS</b>	8
PROGRAMMABLE SHUNT	10
DRIVE SELECT OPTIONS	10
HEAD LOAD OPTIONS	10
HEAD SELECT OPTIONS	11
Head Select from DIRECTION Lines	11
Head Select from Drive Select Lines	11
RADIAL READY OPTIONS	11
RADIAL INDEX OPTIONS	11
IN USE OPTIONS	11
DOOR LOCK OPTION	11
WRITE PROTECT OPTION	11
DISK CHANGE (ALTERNATE OUTPUT)	11
DISK 2 SENSE (ALTERNATE OUTPUT)	11
<b>PHYSICAL INTERFACE</b>	12
CONNECTORS AND CABLES	12
Signals (P1/J1)	12
DC Power (P5/J5)	13
AC Power (P0/J1)	13
TERMINATORS	13

## GENERAL

The Qume DataTrak 8 Flexible Disk Drive is a low cost direct access data storage device that utilizes a removable IBM diskette or equivalent as storage medium.

It is compatible with the following IBM Diskette Drives.

- Single Sided IBM 3740 and Systems 32 Drives; 33FD
- Two-Sided IBM 3600 and 4964 Drive; 43FD
- Two-Sided double density IBM System 34

DataTrak 8 provides a storage capacity of 0.6M Bytes on a two sided single density flexible disk, (IBM DISKETTE 2 or equivalent) and 1.2M Bytes on the two sided double density flexible disk, (IBM Diskette 2D or equivalent).

The DataTrak 8 has a two sided head carriage assembly containing two, proven ceramic read/write heads, and a flexured mounting arrangement that results in extremely high reliability.

Faster access time (3ms track to track) is accomplished by a simple, precise steel belt drive with low power dissipation and minimal wear.

Standard features include:

- Negative DC power supply not required
- Up to 4 drives can be daisy chained together
- ISO Write protect
- Program controlled door lock
- LED activity indicator on the front panel

The Datatrak 8 operates when mounted 2 drives horizontally, or 3 vertically within a standard 19 inch rack and panel unit. A single restriction is made when the drive is mounted horizontally. The proper side must be up, as is described later under MOUNTING.

DataTrak 8 provides both physical and electrical interface compatibility with the Shugart SA850.

## SPECIFICATION SUMMARY

### Performance Specifications

	Single Density	Double Density
<b>Capacity per disk</b>		
<b>Unformatted</b>	<b>0.8M Bytes</b>	<b>1.6M Bytes</b>
<b>IBM Format</b>	<b>0.6M Bytes</b>	<b>1.2M Bytes</b>
<b>Recording Density (Track No. 76)</b>	<b>3408 B P I</b>	<b>6816 B P I</b>
<b>Track Density</b>	<b>48 T P I</b>	<b>48 T P I</b>
<b>Number of Cylinders</b>	<b>77</b>	<b>77</b>
<b>Number of Tracks</b>	<b>154</b>	<b>154</b>
<b>Recording Method</b>	<b>FM</b>	<b>MFM</b>
<b>Rotational Speed</b>	<b>360 RPM</b>	<b>360 RPM</b>
<b>Transfer Rate</b>	<b>250K Bits/sec</b>	<b>500K Bits/sec</b>
<b>Latency (Average)</b>	<b>83 ms</b>	<b>83 ms</b>
<b>Access Time</b>		
<b>Average</b>	<b>91 ms</b>	<b>91 ms</b>
<b>Track to Track</b>	<b>3 ms</b>	<b>3 ms</b>
<b>Settling</b>	<b>15 ms</b>	<b>15 ms</b>
<b>Head Load Time</b>	<b>35 ms</b>	<b>35 ms</b>
<b>Motor Start Time</b>	<b>2 sec</b>	<b>2 sec</b>

# INSTALLATION REQUIREMENTS

AC Power Requirements	100/115VAC Installations	Volts 100/115VAC $\pm$ 10% 50/60 Hz $\pm$ 1%	Current 0.8A Max. (Start up) 0.4A Max. (Running)
	200/230VAC Installations	200/230VAC $\pm$ 10% 50/60 Hz $\pm$ 1%	0.6A Max. (Start up) 0.3A Max. (Running)
DC Power Requirements	Voltage	Max. Ripple	Current (amps)
	+ 24V $\pm$ 10%	0.1V (p-p)	1 drive    2 drives    3 drives    4 drives Typ.    0.7    0.8    0.9    1.0 Max.    1.0    1.2    1.4    1.6
	+ 5V $\pm$ 5%	0.05V (p-p)	Typ.    0.9    1.6    2.3    3.0 Max.    1.3    2.2    3.1    4.0
Power Dissipation	55W (190BTU/Hr) Max.		
Environment	Temperature	Operating 5°C to 43°C (41°F to 110°F)	Storage -10°C to 45°C (14°F to 113°F)
	Relative Humidity	20 to 80% RH	8 to 80% RH
	Max. Wet Bulb	29°C (84°F)	No Condensation
Mechanical	Height	117mm (4.55 in)	
	Width	217mm (8.55 in)	
	Depth	370mm (14.57 in)	
	Weight	6 Kg (13 lbs.)	
Mounting Positions	Horizontal front load (right side up only) Vertical front load Vertical top load		

**NOTES:**

- DC power voltage is specified at DC power connector (J5) on PCB.
- DC supply current is for drives that are normally installed without customer options.
- If stepper motor and door solenoid are energized on all drives continuously, the maximum current requirement for the +24V is 1.0A times the number of drives on the line.

## RELIABILITY AND MAINTENANCE

<b>Error Rate</b>	
<b>Recoverable Read Error Rate</b>	One error per 10 <sup>9</sup> bits read
<b>Non-Recoverable Read Error Rate</b>	One error per 10 <sup>12</sup> bits read
<b>Seek Error Rate</b>	One error per 10 <sup>8</sup> seeks
<b>MTBF</b>	6000 power on hours
<b>MTTR</b>	30 minutes
<b>Preventive Maintenance</b>	6,000 power on hours or 2 years
<b>Design Life</b>	15,000 power on hours or 5 years
<b>*Media Life</b>	3.5 x 10 <sup>8</sup> passes/track

\*Media Life is over when "head output" is reduced to 80% of initial value, as measured by using IBM Diskette (IBM P/N 1766872).

## MOUNTING

### Mechanical Dimensions

The mounting and clearance dimensions for the DataTrak 8 are shown below.

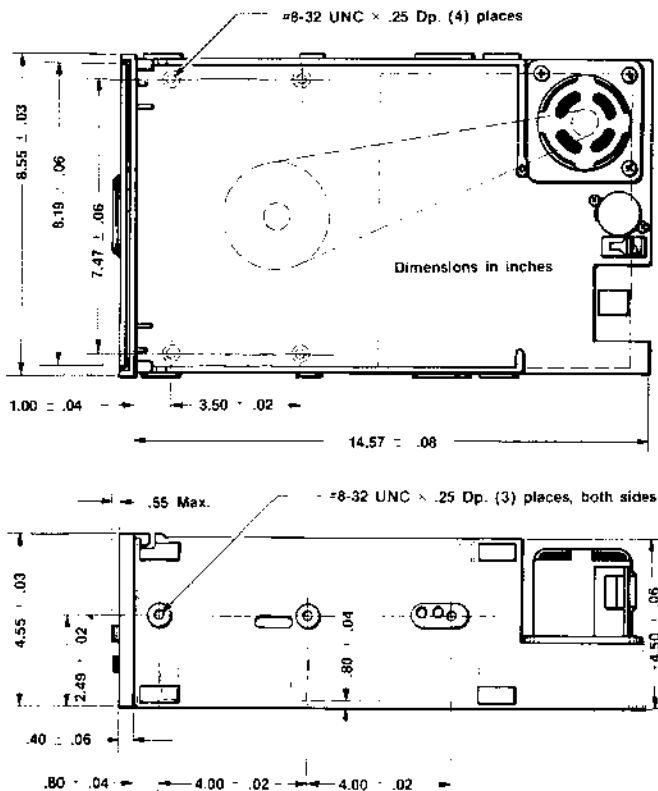

### Recommendations

The DataTrak 8 can be mounted in any plane (horizontal front load, vertical front load, vertical top load).

When the DataTrak 8 is mounted in a horizontal front load position, the button on the front bezel must be under the front door as shown below.

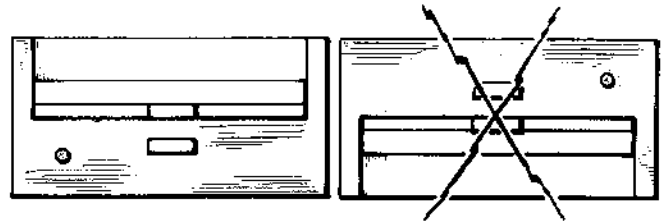

Properly installed  
PCB down)

Improperly installed  
(PCB up)

## IBM COMPATIBILITY

The DataTrak 8 uses a standard 8 inch flexible disk (IBM Diskette, P/N 1766872 or equivalent) as the recording medium.

The DataTrak 8 complies with the physical and electrical characteristics described below for full compatibility with an IBM system.

### TRACK POSITIONING

The DataTrak 8 positions the R/W head to the center line of track 40 to within  $\pm 0.03$  mm ( $\pm 0.0012$  of an inch). Track 40 positioning accuracy can be checked by using a Qume CE Disk (P/N 50152-01).

### READ/WRITE/ERASE HEAD

The geometry of the DataTrak Read/Write/Erase head is equivalent to the IBM Read/Write/Erase head.

#### Read output level

The DataTrak 8 read output level, as measured by the following procedure, satisfies the requirements listed in the table below:

Data is written by the DataTrak 8 on the standard media (IBM Diskette P/N 1766872).

The read output level from the standard media above is checked between test point TP1A and TP1B on the same drive. TP1A and TP1B are the integrated outputs of the head preamplifier.

Track	Output (all '1')	Resolution	=	$\frac{\text{all '1' output}}{\text{all '0' output}} \times 100$
76	100 mV p-p MIN.	40% MIN.		

#### Write current

IBM Compatibility requires a 20% reduction in write current on tracks 44 through 76.

## INDEX POSITIONING

The DataTrak 8 Index Sensor adjustment allows precise positioning in relation to the read/write head gap.

The dynamic positional difference of the DataTrak 8 is within  $\pm 500$  us, which can be checked by using a Qume CE disk (P/N 50152-01).

## ELECTRICAL INTERFACE

DataTrak 8 has three interface connectors. One connector (P1/J1) is for data signals. A second connector (P5/J5) interfaces the DC power +5V and +24V sources. The third connector (P0/J0) interfaces the AC power source. The interface connections are shown on page 5.

## SIGNAL INTERFACE

All lines in the signal interface are TTL compatible, active (true) when low.

DataTrak 8 uses the 7438 driver as a line driver and 7414 schmitt trigger inverter as a line receiver. The input of each receiver is terminated in 150 ohms to +5V.

The figure following shows the recommended controller interface circuits.

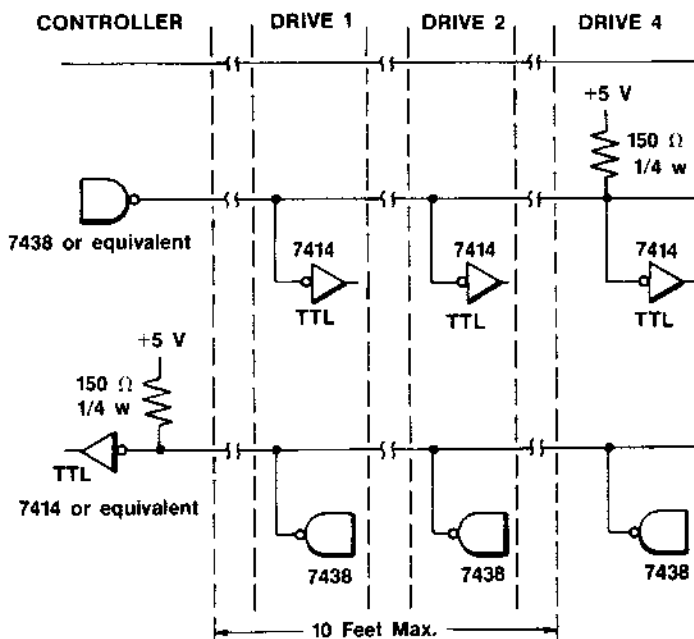

## OUTPUT LINES

There are seven (7) output lines from the DataTrak 8; five (5) are standard and two (2) are optional. Each line has the following properties.

High Level:	False	2.4 to 5.25V, MAX. cutoff current 250uA
Low Level:	True	0 to 0.4A, MAX. sink 48mA

## INPUT LINES

There are twelve (12) low active TTL input lines to DataTrak 8. Ten (10) are standard and two (2) are user installable options. Individual signal line characteristics are described below.

High Level:	False	2.4 to 5.25V
Low Level:	True	0 to 0.4V
Impedance:		150 ohms to 5V Line

### DRIVE SELECT 1-4

A low active level on this line enables communication between the individual drive and the controller.

When two or more (up to 4) drives are daisy chained, each drive must have a unique DRIVE SELECT address. The DRIVE SELECT address is controlled by jumpers DS1 through DS4. When the two pads of jumper DS1 are connected, the drive will be activated by an active low signal on the DRIVE SELECT number one line. If the two pads of jumper DS2 are connected, the drive will be active when DRIVE SELECT line number two is low active. The same system applies to jumpers DS3 and DS4.

### NOTE

Only one jumper can be connected within a single drive. Each drive within a daisy chain must have a unique DRIVE SELECT number.

### DIRECTION

Direction (pin 34) defines the direction of read/write head movement when the STEP line is pulsed. A low level on this line causes the Head Position Mechanism to move the read/write head toward the center of the disk when STEP is pulsed. With the Direction line at a high level, a pulse on the STEP line causes the Head Position Mechanism to move the read/write head away from the center of the disk. DIRECTION is changed by the trailing (positive going) portion of the step pulse (see the timing diagram). The logic state of DIRECTION can be changed at any time after the trailing (positive going) edge of the STEP pulse, and to within 1 microsecond before the trailing edge of a following STEP pulse. The logic state of DIRECTION cannot be changed during the positive going transition of STEP, or within the preceding 1 microsecond of the positive going transition of STEP.

### STEP

A low active level on this line will cause the read/write head to be moved one track. The direction of movement is controlled by the DIRECTION line.

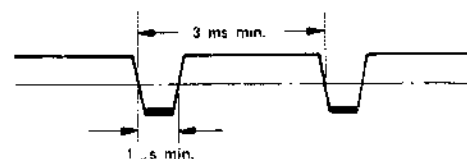



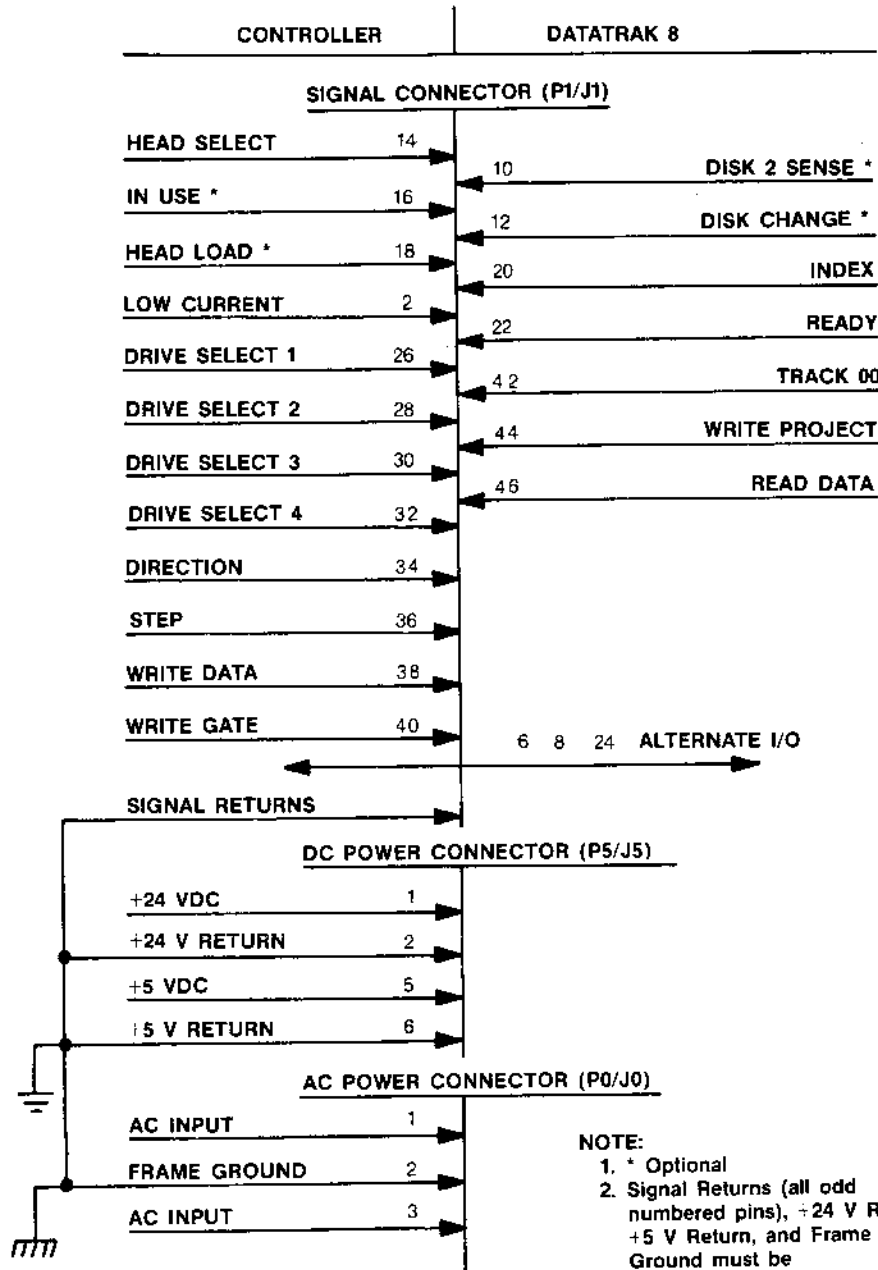

**NOTE:**  
 1. \* Optional  
 2. Signal Returns (all odd numbered pins), +24 V Return, +5 V Return, and Frame Ground must be connected together at the controller.

Interface Connections

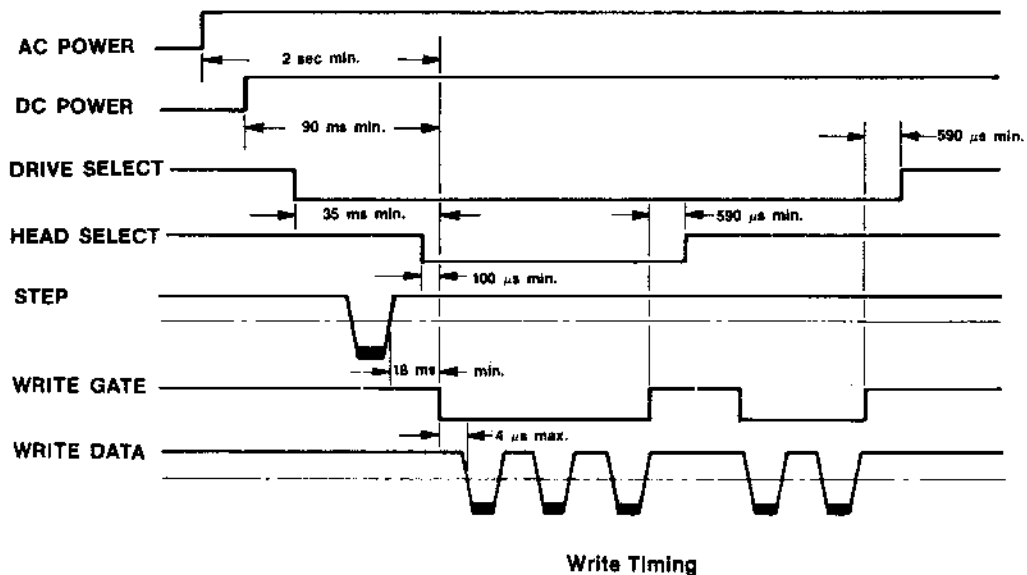
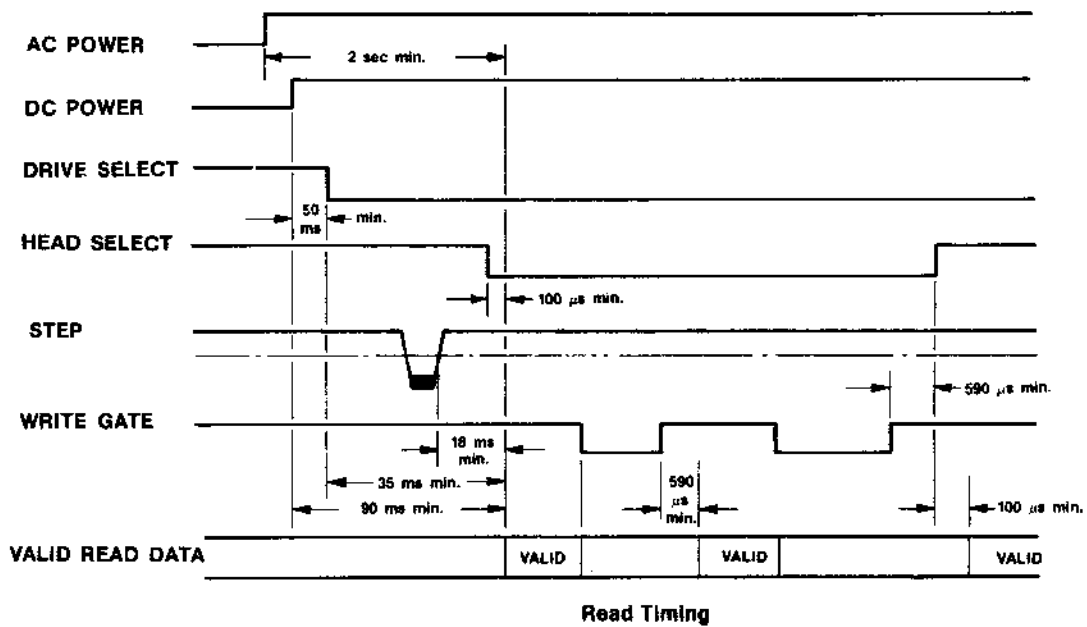
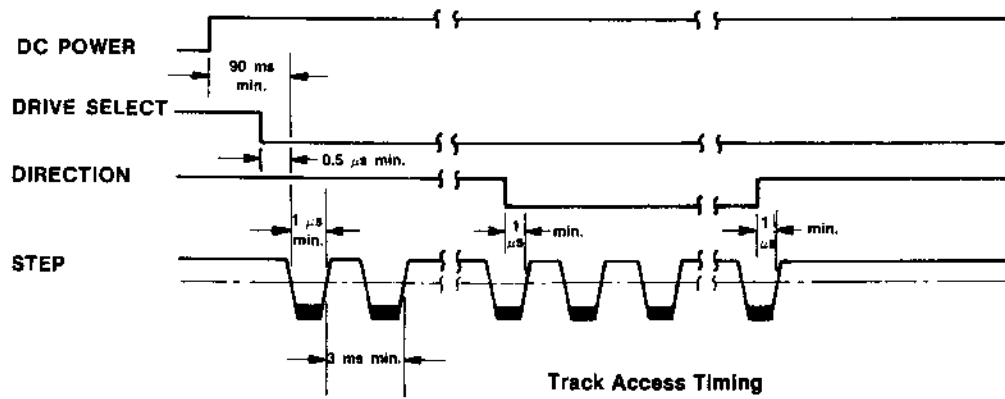

### Write Data

This interface line provides the data to be written on the disk. Each transition from high state to a low active level on this line causes the write current through the head to be reversed.

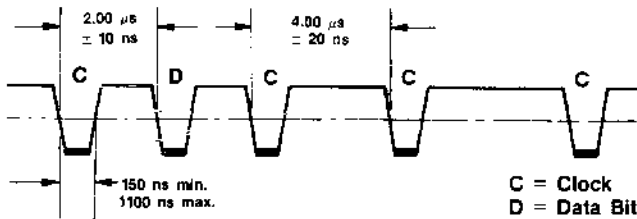

Frequency Modulation (FM)

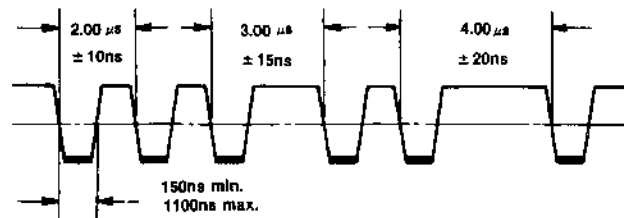

Modified Frequency Modulation (MFM)

### Write Gate

A low active level on this line enables the write current source, and disables the stepping (head movement) circuitry. A high level on this line enables the read circuitry. Deactivation of DRIVE SELECT, and/or changing HEAD SELECT must be delayed at least 590  $\mu\text{s}$  following a write operation to assure that the track is fully tunnel erased.

Refer to the READ TIMING and WRITE TIMING diagrams for the timing relationships.

### Head Select

Head Select defines which surface of a two sided media disk is used for data recording or retrieval. A low active level on this line selects the R/W head for surface 1. A high level on this line selects the R/W head for surface 0 of the disk. When switching from side 0 to side 1 and conversely, 100  $\mu\text{s}$  delay is required before any read or write operation can be initiated. Refer to Customer STRAPPABLE OPTIONS for alternate head select.

### Low Current

A low active level on this line is required for writing on tracks 44 through 76. This input is used to lower the write current by 20%, consequently improving the read output resolution of the inner tracks.

### Head Load

A low active level on this option input, when READY is active, causes the R/W head to be loaded against the disk.

Refer to Customer STRAPPABLE OPTIONS for uses and method of installation.

### In Use

Refer to CUSTOMER STRAPPABLE OPTIONS for uses and variations.

### Index

This interface signal is provided by the drive once each revolution. The leading (negative going) edge of INDEX pulse indicates the beginning of the track.

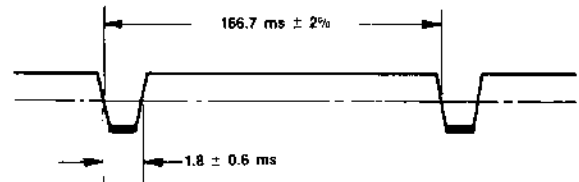

### Ready

A low active level on this line indicates that at least two index pulses have been sensed after properly inserting a disk and closing the door, or applying +5V power to the drive.

Refer to CUSTOMER STRAPPABLE OPTIONS for alternate use of READY.

### Track 00

A low active level on this line indicates that the R/W head is positioned at Track 00.

### Write Protect

A low active level on this line indicates that a disk with an ISO write protect notch is loaded.

Under normal operation, the drive will also inhibit writing when a protected disk is installed.

Refer to CUSTOMER STRAPPABLE OPTIONS for alternate operation.

### Read Data

Data from the disk is output to the host system in the same form as it was received on the write data line. Each flux reversal that is sensed on the disk produces a transition to a low active level on the READ DATA line.

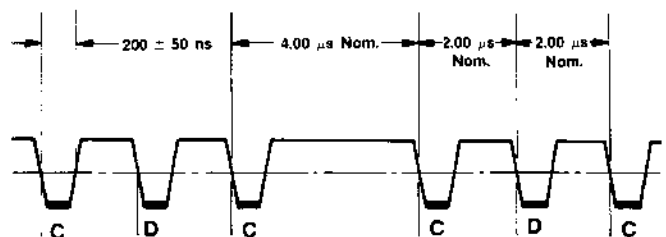

C = Leading Edge of Bit Can Be  $\pm 350 \text{ ns}$  From Nominal.  
D = Leading Edge of Bit Can Be  $\pm 175 \text{ ns}$  From Nominal.

### Disk Change

Refer to CUSTOMER STRAPPABLE OPTIONS.

### Disk 2 Sense

Refer to CUSTOMER STRAPPABLE OPTIONS.

## ALTERNATE I/O PINS

Seven (7) alternate I/O pins are provided for alternate control signal interface pins. Each alternate I/O pin has a pad provided for customer installable jumpers. These seven pins allow additional signals to be brought (pins 6, 8, 10, 12, 16, 18, 24) to the interface by optional jumpers.

Two (2) optional output lines and two input lines are connected through normally open traces to four interface lines (pins 10, 12, 16, 18).

## CUSTOMER STRAPPABLE OPTIONS

DataTrak 8 can be modified by the user to alter functions that are described previously. These modifications are made by adding or deleting traces and by using the Alternate I/O pins. The following table shows the configuration of the option traces and jumpers as shipped from the factory.

Trace Designator	Description	From Factory	
		Open	Short
DS1 - DS4	Drive address select pins (up to 4 drives)	DS2, DS3 DS4	DS1
A, B, X	Radial HEAD LOAD		X
Z	IN USE from DRIVE SELECT		X
HL	Stepper power from HEAD LOAD		X
R	READY alternate output pad		X
I	INDEX alternate output pad		X
C	Alternate input HEAD LOAD	X	
D	Alternate input IN USE	X	
DC	Alternate output DISK CHANGE	X	
2S	Alternate output DISK 2 SENSE	X	
DS	Stepper power from DRIVE SELECT	X	
Y	IN USE from HEAD LOAD	X	
DL	Door lock latch	X	
RR	Radial READY		X
RI	Radial INDEX		X
WP	Inhibit write when WRITE PROTECT		X
NP	Allow write when WRITE PROTECT	X	
D1, D2, D4, DDS	Drive address, select pins (up to 8 drives)	X	
B1 - B4	Two, double sided drive select	X	
S1 - S3	Head select option	S1, S3	
6, 8, 10, 12 16, 18, 24	Alternate I/O pins	X	

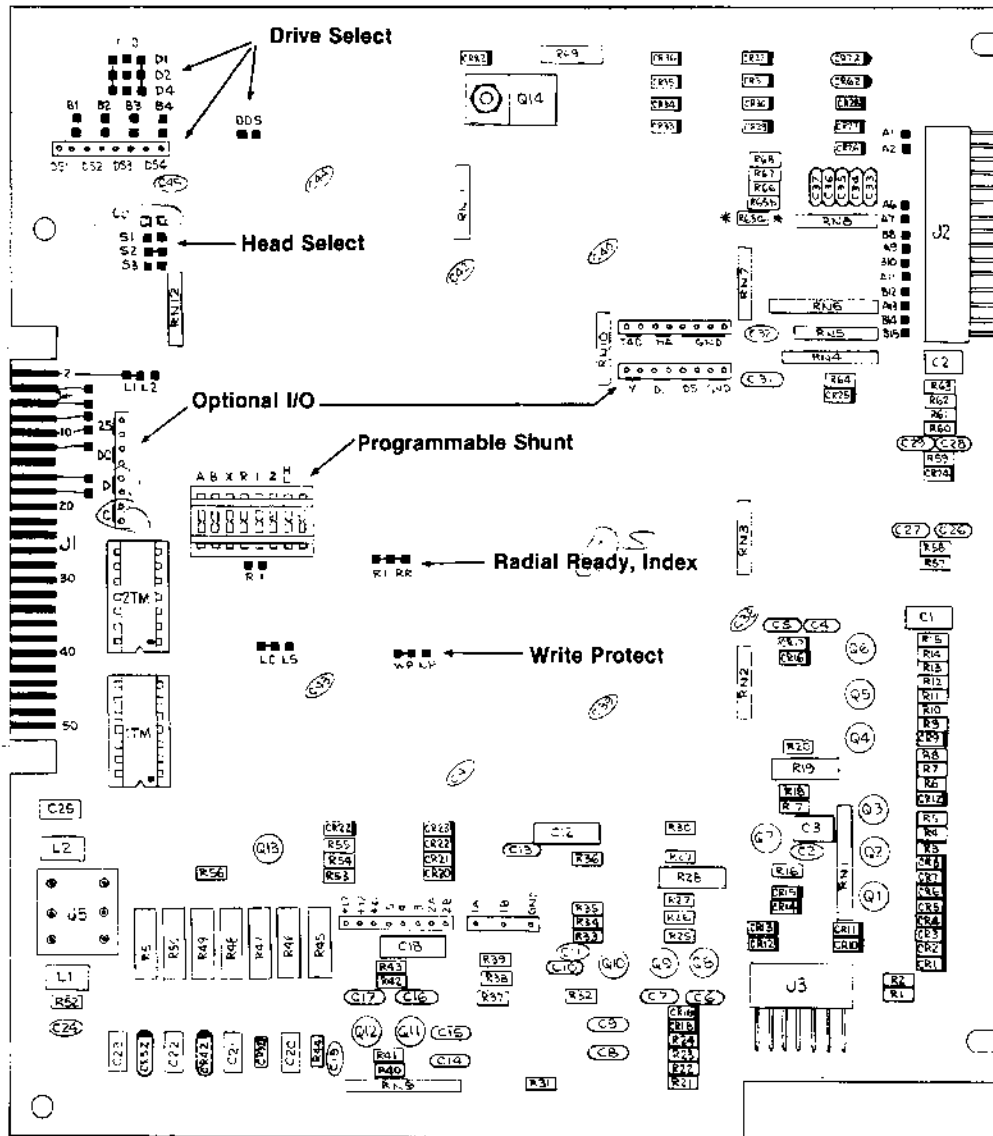

PCB Jumper Locations

## PROGRAMMABLE SHUNT

A 16 pin programmable shunt is provided for seven most commonly used trace cut options. All of these traces are usually shorted when shipped from the factory. The shorted and open functions of the pluggable options are shown below.

Trace	Function-Normally Shorted	Function-Open
A	(DS) = DRIVE SELECT	(DS) = DS AND HEAD LOAD
B	(DS) = DRIVE SELECT	(DS) = DRIVE SELECT (HL) = HEAD LOAD
X	(HL) = DS	(HL) = DRIVE SELECT OR IN USE
Z	(IN USE) = DS	(IN USE) = HEAD LOAD OR IN USE
HL	Stepper Power = DRIVE SELECT	Stepper Power = always active
R	READY for multiplex mode	READY for radial mode
I	INDEX for multiplex mode	INDEX for radial mode

### NOTE

Radial mode allows controller to check READY and/or INDEX lines on all drives without DRIVE SELECT.

### NOTE

Multiplex mode requires DRIVE SELECT to check READY and/or INDEX line on any drive.

## DRIVE SELECT OPTIONS

Normally, up to four drives can be addressed in a daisy chain system.

This option allows up to eight drives to be multiplexed together. Four DRIVE SELECT lines are to be used for addressing the drive. DRIVE SELECT 1 is used as DRIVE SELECT enable, DRIVE SELECT 2 (binary 1), DRIVE SELECT 3 (binary 2) and DRIVE SELECT 4 (binary 4) are the address lines. The logical drive assignment is accomplished by properly jumpering the Traces D1, D2, D4, where D1 = (binary 1), D2 = (binary 2) and D4 = (binary 4). The jumper pads are arranged to appear as a 3X3 matrix. The three pads in the vertical center column must each be jumpered to either the left column (1) or the right column (0). The proper jumpers for each drive select number are shown in the table below.

1. Add a 74L85, 4 bit comparator in IC location 1K.
2. Jumper trace DDS, unplug trace DS1-DS4.
3. Jumper properly traces D1, D2 and D4.

Drive Number	Drive Select Input				Jumper Center Pad to:		
	1	2	3	4	D1	D2	D4
0	L	H	H	H	0	0	0
1	L	L	H	H	1	0	0
2	L	H	L	H	0	1	0
3	L	L	L	H	1	1	0
4	L	H	H	L	0	0	1
5	L	L	H	L	1	0	1
6	L	H	L	L	0	1	1
7	L	L	L	L	1	1	1

L = low level, H = high level

## HEAD LOAD OPTIONS

Normally, when a drive is selected, its head is loaded and the stepper is energized.

Option 1. Allows a drive to be selected without loading head or enabling stepper. The advantage of this option is that the output signals can be monitored while head is unloaded, thereby extending the media life.

Option 2. Allows a drive to be selected and stepper to be enabled without loading head. An example of this option is that initial reset to Track 00 at power-on can be performed without the READY condition.

Option 3. (Radial READY) allows a drive to be head loaded, without selecting drive or enabling stepper. The advantage of this option is that the head can be kept loaded on all drives thereby eliminating the head load time at the disk copy operation.

The following table lists the Head Load options and the required straps.

## DRIVE SELECT/HEAD LOAD OPTIONS

Logic	Normal	Option 1	Option 2	Option 3
DRIVE SELECT (DS)	(DS) = DS	(DS) = DS	(DS) = DS	(DS) = DS*HL
HEAD LOAD (HL)	(HL) = DS*R	(HL) = HL*DS*R	(HL) = HL*R	(HL) = HL*R
Stepper Power (SP)	(SP) = (HL) = DS*R	(SP) = (HL) = HL*DS*R	(SP) = (DS) = DS	(SP) = (DS) = DS*HL
Installation		Unplug X Plug C	Unplug B Unplug HL Plug DS Plug C	Unplug A Unplug HL Plug DS Plug C

R = READY, ( ) means drive interval logic, \* = AND logic function

## HEAD SELECT OPTIONS

Normally, a head is selected by the HEAD SELECT interface line in a daisy chain system of up to four drives.

### Head Select From DIRECTION Line.

This option allows both HEAD SELECT and DIRECTION to be multiplexed on the same DIRECTION line. By cutting trace S2, and jumpering trace S1, head selection is controlled by the DIRECTION line. DIRECTION can be used in this way because it is not being used during R/W (STEP must accompany DIRECTION to initiate head movement).

### Head Select From DRIVE SELECT Lines.

This option uses the existing DRIVE SELECT lines to address up to two double sided drives. It selects up to four sides as if the sides were separate drives.

1. Cut trace S2, and jumper trace S3. The sides are then selected as follows:

DRIVE NUMBER	HEAD SELECT	DRIVE SELECT input				Traces
		1	2	3	4	
1	0	L	H	H	H	plug DS1
1	1	H	L	H	H	jumper B2
2	0	H	H	L	H	plug DS3
2	1	H	H	H	L	jumper B4

L = low level, H = high level

## RADIAL READY OPTIONS

Normally, the READY line from a drive is only available to the interface when it is selected. This option enables the user to monitor the READY line of each drive on the interface all the time.

1. Cut trace RR.
2. Unplug trace R and jumper the pad R to one of the Alternate I/O pins. READY will then appear on the chosen Alternate I/O pin.

## RADIAL INDEX OPTIONS

Normally, the INDEX line from a drive is only available to the interface when it is selected. This option enables the user to monitor the INDEX line of each drive on the interface all the time.

1. Cut trace RI.
2. Unplug trace I and jumper pad I to one of the Alternate I/O pins. INDEX will then appear on the chosen Alternate I/O pin.

## IN USE OPTIONS

Normally, the activity LED indicator will be turned on when DRIVE SELECT is active. The door will be activated when DRIVE SELECT and READY are active.

This optional input, when activated to a low level, will turn on the activity LED. For uses and method, refer to Table below.

Logic	Option 1	Option 2	Option
IN USE	(IN USE) = IN USE + DS	(IN USE) = IN USE + HL	(IN USE) = (IN USE)
INSTALLATION	Plug D	Plug D Unplug Z Plug Y	Plug D Unplug Z

+ = OR logic function

## DOOR LOCK LATCH OPTION

With this option, the door lock actuator can be latched without maintaining the IN USE signal throughout the door lock interval. IN USE may be activated by DRIVE SELECT.

1. Plug trace D.
2. Plug trace DL.

## WRITE PROTECT OPTION

With this option installed, a Write Protected disk will not inhibit writing but it will be reported to the controller.

1. Cut trace WP and jumper trace NP.

## DISK CHANGE (Alternate Output)

A low active level on this option line indicates that the READY signal has gone false (door opened) after DRIVE SELECT went false. The DISK CHANGE circuit is reset on the true to false (low/high) transition of DRIVE SELECT provided that the drive is READY. See the figure below.

1. Plug (jumper) DC

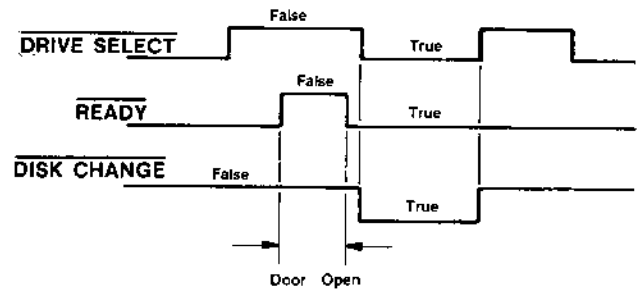

Disk Change Timing

## DISK 2 SENSE (Alternate output)

A LOW level on this line indicates that a two-sided diskette is in use, and a HIGH level on this line indicates that a single-sided diskette is in use.

1. Plug trace 2S.

## PHYSICAL INTERFACE

The interface between DataTrak 8 and the host system is via three (3) connectors: I/O Signal (P1/J1), DC power (P5/J5), AC power (P0/J0).

Refer to ELECTRICAL INTERFACE for specific pin connections.

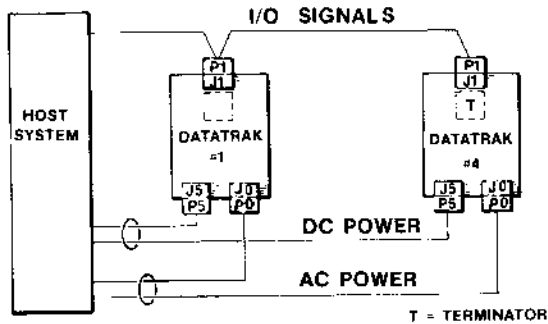

Interface Connection

## CONNECTORS AND CABLES

Signals (P1/J1).

Connector J1

Connection to J1 is through a 50 pin PCB edge card connector. The dimension for this connector is shown in the figure below.

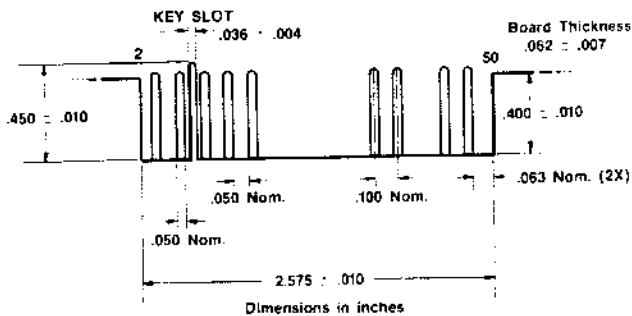

J1 Connector Dimensions (component side)

Connector P1 for a flat cable.

Parts		3M P/N
Connector		3415-0001
Polarizing Key		3439-0000
Crimp Tool	Press	3440
	Locator Plate	3443-11
	Platen	3442-1
Flat Cable (10' MAX.)		3365-50

Connector P1 for a twisted pair.

Parts	Crimp type	Solder type	
	AMP P/N	AMP P/N	VIKING P/N
Housing	1-583717-1	1-583717-1	3VH25/1JN-5
Contact	583616-5	583854-3	--
Polarizing Key	583274-1	583274-1	091-0071-000
Crimp Tool	90268-1	--	--
Extractor Tool	91073-1	91073-1	--
Twist Pair (20 feet MAX.)	AWG 26	AWG 26	AWG 26

Signal connector pin assignments.

Signal Return	Signal	Signal Name	
Pin No.	Pin No.	Standard	Option
3,5,7	6, 8	Alternate I/O	
1	2	Low Current	
9	10	Alternate I/O	TWO SIDED
11	12	Alternate I/O	DISK CHANGE
13	14	SIDE SELECT	Alternate I/O
15	16	Alternate I/O	IN USE
17	18	Alternate I/O	HEAD LOAD
19	20	INDEX	
21	22	READY	
23	24	Alternate I/O	
25	26	DRIVE SELECT 1	
27	28	DRIVE SELECT 2	
29	30	DRIVE SELECT 3	
31	32	DRIVE SELECT 4	
33	34	DIRECTION	
35	36	STEP	
37	38	WRITE DATA	
39	40	WRITE GATE	
41	42	TRACK 00	
43	44	WRITE PROTECT	
45	46	READ DATA	
47	48	reserved	
49	50	reserved	



*D. C. Power (P5/J5)*

Parts	P5 (Cable Side)	J5 (Drive Side)
	AMP P/N	AMP P/N
Housing	1-480270-0	1-380999-0
Contact (6 pins)	60619-1	--
Crimp Tool	90124-2	--
Extractor Tool	1-305183-2	--
Cable (10 feet MAX.)	AWG 18 or 16	--

DC Connector Pin Assignment

Pin No.	Signal Name
1	+ 24V DC
2	+ 24V RETURN
3	reserved
4	reserved
5	+ 5V DC
6	+ 5V RETURN

*A. C. Power (P0/J0)*

Parts	P0 (Cable Side)	J0 (Drive Side)
	AMP P/N	AMP P/N
Housing	1-480700-0	1-480701-0
Contact (3 pins)	350550-1	350705-1 and 350669-1
Crimp Tool	90296-1	90296-1
Extractor Tool	458994-1	458994-1
Cable (20 feet MAX.)	AWG 18 or 16	AWG 18 or 16

AC Connector Pin Assignment

Pin No.	Signal Name
1	AC INPUT
2	FRAME GROUND
3	AC INPUT

**TERMINATORS**

The terminators consist of two DIP resistor modules which may be plugged into DIP sockets on the PCB of the last drive in a daisy chain.

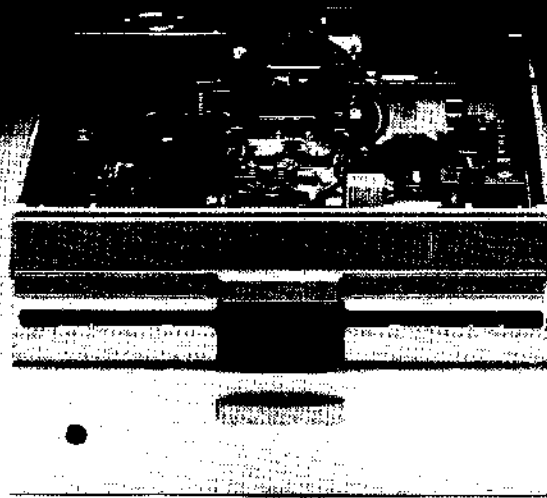

## The DataTrak 8 Floppy Disk Drive from Qume.

The DataTrak 8 double-sided, double-density, drive uses state-of-the-art technology to give you superior data integrity through improved disk life, data reliability, and drive serviceability.

Qume's innovative approach to controlling head load dynamics yields wear characteristics far superior to competitive drives. In independent evaluation, DataTrak 8 is setting industry standards for tap

test performance. This superior wear performance produces savings on both diskette usage and drive maintenance.

Improved data reliability, resulting from superior amplitude and bit shift characteristics, optimizes operator efficiency and reduces processing time for end-users.

And DataTrak's unique modular design means simplified field servicing for you and your customers.

### KEY FEATURES

- Greatly extended disk life
- Easier field serviceability
- Improved data reliability
- IBM compatibility
- Write protect circuitry
- Activity LED indicator

**Qume®**

## Design Features

### Expanded storage capacity

- Two-sided, double density

### Fully IBM compatible

- IBM 3740 and System 32 drives
- IBM 3600 and 4964 drives
- IBM System 34 drives

### Proven head carriage assembly

- Ceramic head with tunnel erase
- Dual-head flex mounting arrangement
- Superior head load dynamics

### Fast, precise steel belt drive

- Fast access time — 3 ms track-to-track
- Low friction and minimum wear
- Low power dissipation

### Additional features

- ISO standard write protect
- Programmable door lock
- Negative DC voltage not required
- Daisy chain up to 4 drives
- Side-by-side mounting in standard 19" RETMA rack

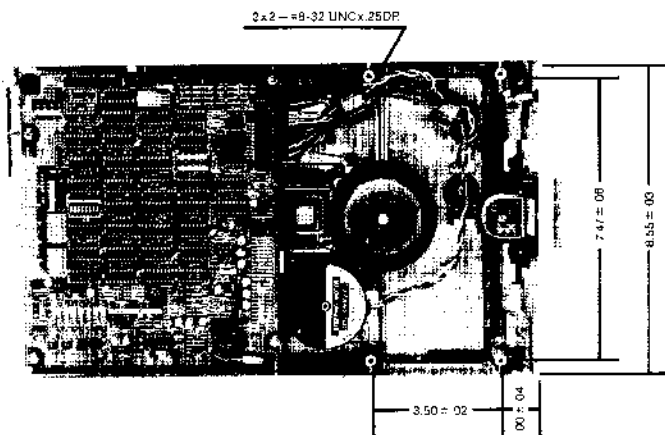
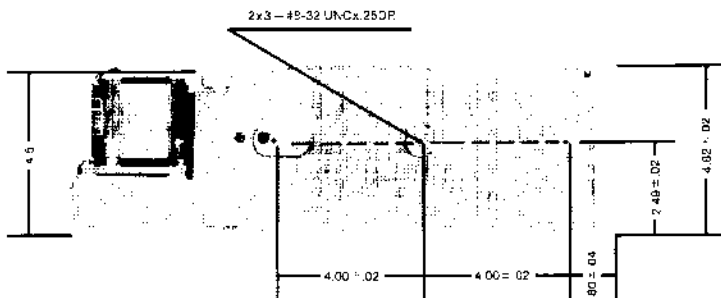
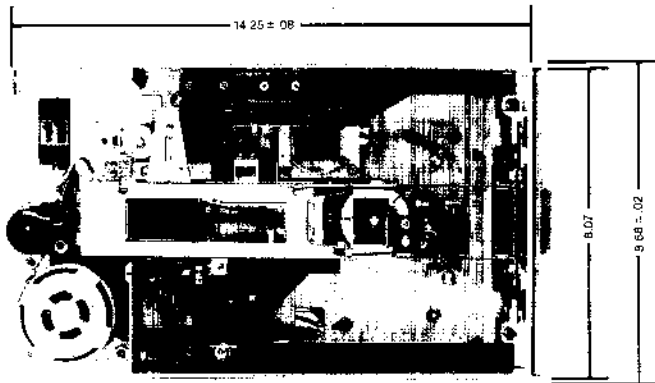

## Product Specifications

### Performance Specifications

#### Capacity

Unformatted	1.6 Mbytes/disk
IBM format	1.2 Mbytes/disk

#### Recording density

6816 BPI

#### Track density

48 TPI

#### Cylinders

77

#### Tracks

154

#### Recording method

MFM

#### Rotational speed

360 RPM

#### Transfer rate

500K bits/sec

#### Latency (avg.)

83 ms

#### Access time

Track-to-track 3 ms

Settling 15 ms

Average 91 ms

#### Head Load Time

35 ms

#### Disk

Diskette 2D or equivalent

### Installation Requirements

#### Power requirements

AC: 100/115 VAC ( $\pm 10\%$ ), 50/60Hz ( $\pm 1\%$ ) 0.4A max.

200/230 VAC ( $\pm 10\%$ ), 50/60Hz ( $\pm 1\%$ ) 1.3A max.

DC: +24V ( $\pm 10\%$ ), 1.0A max.

+5V ( $\pm 5\%$ ), 1.3A max.

#### Power dissipation

55W

#### Operating environment

Temperature 41°F to 110°F (5°C to 43°C)

Relative humidity 20% to 80%

Max wet bulb 85°F (29°C)

#### Mechanical dimensions

Width 4.62 in. (117 mm)

Height 8.55 in. (217 mm)

Depth 14.57 in. (370 mm)

Weight 13 lbs. (6kg)

### Maintenance and Reliability

MTBF 6000H

MTTR 0.5H

PM 6000H or 2 years

#### Error rate

Soft read error  $1/10^9$  bits read

Hard read error  $1/10^{12}$  bits read

Seek error  $1/10^6$  seeks

Design life 15,000H or 5 years

Media life  $3.5 \times 10^6$  passes/track

# Qume®

2323 Industrial Parkway West

Hayward, CA 94545

Tel: (415) 783-6100, TWX: 910-383-0192