

Drive C

User's Manual



Drive C USER'S MANUAL for Osborne 1 Computers

SECOND EDITION, June 1984

This User's Manual and the software programs it describes are:

Copyright (C) 1984
Drive C:, a joint venture
All Rights Reserved.

The following trademarks used in this manual are the property of these companies:

Drive C	Drive C:
TurboPac	Drive C:
QuickPac	Drive C:
BackPac	Drive C:
Trantor	Trantor Systems Limited
Osborne 1	Osborne Computer Corp.
Executive	Osborne Computer Corp.
CP/M	Digital Research Inc.
WordStar	MicroPro International Corp.
SuperCalc	Sorcim, Inc.
dBASE II	Ashton-Tate, Inc.

Thank You!

We thank you for becoming a Drive C owner.

We've made every effort to make your Drive C simple to learn and easy to use.

This manual is designed to help you learn how to use the many features of your Drive C as well as how to derive the maximum benefits from your Osborne 1.

Most new computer owners have difficulty working with the apparent complexity of their computer. It's simple if you take it one step at a time.

The Drive C User's Manual provides step-by-step instructions for installing and using Drive C. Each step includes an actual practice exercise with your Drive C.

While it may appear that there are a lot of exercises, they take just a few minutes to do. Just follow the step-by-step instructions and you'll have your Drive C up and running very quickly.

You'll soon agree the easiest way to learn to use Drive C is simply by using it.

**** SPECIAL THANKS ****

This manual and the new Drive C software package were based largely on advice given us by Drive C owners. We're very proud of all our Drive C products and we hope you will continue to give us advice and feedback. Thanks to all of you who helped.

Table of Contents

SECTION 1	HOW TO USE THIS MANUAL	<u>PAGE</u>
1-1	What's inside and where to find it.....	1
1-2	Symbols and conventions used in this manual.....	2
1-3	Drive C features.....	5
SECTION 2	GETTING STARTED	
2-1	Mechanical installation of Drive C.....	11
2-2	Removing the Drive C unit.....	16
2-3	Using display screens with Drive C.....	17
2-4	Making your copy of the Drive C software.....	19
2-5	For Users of Rev 1.2 Ols.....	22
2-6	Testing your Drive C installation.....	24
2-7	Trouble-shooting the Drive C installation.....	27
2-8	Installing Drive C with your printer.....	28
2-9	Trouble-shooting the parallel printer installation.....	30
2-10	Putting your CP/M onto your DC USER Disk.....	32
2-11	Testing your printer operation.....	35
2-12	Trouble-shooting your printer, Part 2.....	37
2-13	Quick checklist of Drive C installation.....	38
SECTION 3	FITTING Drive C TO YOUR NEEDS	
3-1	The automatic approach.....	39
3-2	The manual approach.....	40
3-3	Using it both ways.....	41
SECTION 4	CP/M TUTORIAL	
4-1	Operating systems.....	43
4-2	Formatting disks.....	45
4-3	Putting CP/M on disks using SYSGEN.....	47
4-4	Files and DIR.....	50
4-5	XDIR.....	53
4-6	Renaming files.....	55
4-7	Copying files with PIP.....	56
4-8	Erasing files.....	60
4-9	CP/M Error messages.....	61
SECTION 5	LEARNING Drive C SKILLS	
USING THE RAM DISK		
5-1	Getting ready.....	63
5-2	Installing the RAM-disk.....	66
5-3	Copying files onto the RAM-disk.....	67
5-4	Saving files from the RAM-disk to floppy.....	68
5-5	Installing the RAM-disk as drive A:.....	70
5-6	Installing Drive C with different drive names.....	71
5-7	Drive C and the RESET button.....	72
5-8	Renaming the RAM-disk after installation.....	74
5-9	Running WS on Drive C - doing it manually.....	76

Table of Contents

USING THE PRINT BUFFER

5-10	Print Buffer operation.....	79
5-11	Installing the Print Buffer.....	81
5-12	The Fixed Print Buffer.....	82
5-13	The Dynamic Print Buffer.....	85
5-14	Using the Dynamic Print Buffer.....	86

USING THE Drive C UTILITY PROGRAM

5-15	DCU - the Drive C Utility Program.....	88
5-16	Using DCU S - the SPACE option.....	90
5-17	Using DCU O - the OPTIMIZE option.....	92
5-18	Using DCU to control the Print Buffer.....	94
5-19	Using DCU without the menu.....	96
5-20	DCU E - erasing the RAM-disk.....	97

SECTION 6 USING YOUR NEW Drive C SKILLS

USING QUICKPAC

6-1	Making Drive C automatic.....	100
6-2	DCQINS - installing the QuickPac options.....	102
6-3	Using QuickPac.....	105

SAVING Drive C FILES

6-4	Getting ready.....	109
6-5	Programs which copy files.....	111
6-6	Using PIP.....	112
6-7	Archive.....	113
6-8	Archive - choosing which files to store.....	114
6-9	Archive - storing files on floppy disk.....	116
6-10	The Archive diskette.....	118
6-11	Using an Archive diskette set.....	119
6-12	Archive - saving all of Drive C.....	120
6-13	Retrieve.....	123

MAKING IT EVEN MORE AUTOMATIC

6-14	Using your function keys.....	128
6-15	The Remote Retrieve command.....	129
6-16	Remote Retrieve with QuickPac.....	130

SECTION 7 APPENDICES

7-1	Using drive C with OI System Utilities.....	131
7-2	Drive C hardware specifications.....	133
7-3	Drive C software specifications.....	134
7-4	Disk and RAM space usage with Drive C.....	135
7-5	Centronics parallel printer cable specifications.....	136
7-6	Patching WordStar for improved printing.....	137
7-7	Modifying QuickPac data files.....	139
7-8	Using ZCPR with Drive C.....	141

How To Use This Manual



CONTENTS

- 1-1 WHAT'S INSIDE AND WHERE TO FIND IT
- 1-2 SYMBOLS AND CONVENTIONS USED IN THIS MANUAL
- 1-3 Drive C FEATURES

1-1 WHAT'S INSIDE AND WHERE TO FIND IT

This manual is divided into several sections to make learning to use your Drive C efficient and easy.

Each section is organized as a learn-as-you-go guide. Please don't try to start in the middle of a section unless you're completely confident you already understand all about Drive C.

Definitely read Section 1-2 next. There we explain all the symbols and abbreviations used throughout this manual.

Section 1-3 gives you an overview of all Drive C features.

Please read Section 2 regardless of your level of skill with your Osborne. If you follow our simple step-by-step installation procedure, you'll find installation straightforward and pleasantly painless. There is a checklist/summary of the installation procedure at the end of Section 2.

In Section 3 we explain how to make Drive C fit the way you use your computer. This section was largely compiled from advice given us by Drive C users. You'll probably want to re-read this section after you've learned how to use Drive C to "lock in" what you've learned.

If you are a beginner with your computer or if you do not use CP/M commands and utilities often, you'll probably want to read Section 4, the CP/M tutorial. If you already use PIP, XDIR and other CP/M utilities feel free to skip this section.

In Section 5 we explain how to use each of the basic features of Drive C, the RAM-disk, the Print Buffer and its Utility program.

Section 6 shows how to use QuickPac and our Archive/Retrieve program for fast-loading and backing up of Drive C.

Section 7 contains several useful appendices. Everyone should read the first appendix on using COPY, SYSGEN and SETUP with Drive C. Some of the other appendices are more technical.



How To Use This Manual

1-2 SYMBOLS AND CONVENTIONS USED IN THIS MANUAL

Below are examples and explanations of the different symbols and conventions used in this manual. Please acquaint yourself with these since they are used throughout the manual.

When we refer to your Drive C unit we will use the term - Drive C

When we mean a logical drive name we will use the term - drive C:

THE RETURN KEY

<CR>, <RETURN>

EXPLANATION: Press the RETURN key.

CONTROL C

^C

EXPLANATION: Hold down the 'CTRL' key and press the 'C' key.

LOGICAL DRIVE INDICATOR

A>

The 'A' prompt

EXPLANATION: The drive prompt that appears on your screen. The letter indicates which logical drive is being used.

SINGLE LINE COMMANDS

A>DCL<CR>

Install Drive C as C:

EXPLANATION: YOUR INPUT is always shown with a WHITE background. The SCREEN DISPLAY for individual command lines is always shown with a GRAY background.

In the above example, the A> is initially on the screen. You would then type DCL followed by pressing the RETURN key.

Your input is always shown literally. If a space is shown in the command, it must be included when you type the command.

To the right of each input is a brief explanation of the command. For example, the command DCL<CR> installs the Drive C unit as the third logical drive, drive C:.

How To Use This Manual



FULL SCREEN INPUTS

Is your unit 384K (Large), or 192K (Small) (L/S)? **L**

Which disks do you want copied to Drive C?

Disk A: or B: or both (A/B/2)? **2**

Are the above choices correct (Y/N)? **Y**

EXPLANATION: When a series of inputs are required as part of a program, the entire sequence of inputs is shown.

Your inputs are shown with a **WHITE** background. The program display is shown with a **GRAY** background.

SYSTEM STATUS ILLUSTRATION

CP/M SYS DISK

A:

B:

WordStar Disk

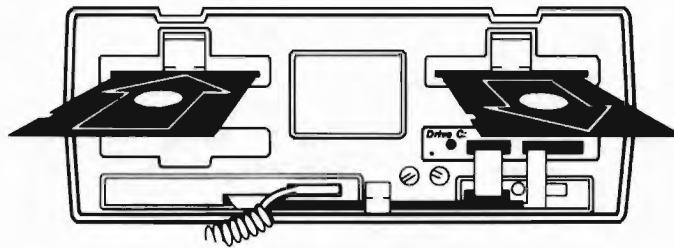

C:

EXPLANATION: Each System Status Illustration displays information-at-a-glance about your Osborne, Drive C and floppy disk drives.

The logical drive **NAMES** for the Drive C unit and the floppy disk drives are displayed above the floppy drives and below the Drive C unit.

The diskette **TITLES** are shown next to the appropriate floppy disk drive.

The arrows on the diskettes indicate whether you should **INSERT** or **REMOVE** a diskette for the next step in the manual.

In the above example, the CP/M Systems and Utilities diskette should be inserted in your left-hand floppy drive named drive **A:**. The WordStar diskette should be removed from drive **B:**. The Drive C unit is installed and is named drive **C:**.

The message 'Drive C: NOT INSTALLED' is displayed whenever Drive C is **NOT** installed as a third drive. It is **NOT** necessary to physically remove Drive C when you see this message.



How To Use This Manual

DC USER DISK

AUTOST	.COM
DCA	.COM
DCL	.COM
DCQ	.COM
DCQ	.DAT
DCQAUT	.COM
DCQINS	.COM
DCU	.COM
DFD	.SPR
PIP	.COM
PRN	.TST
XDIR	.COM

C:

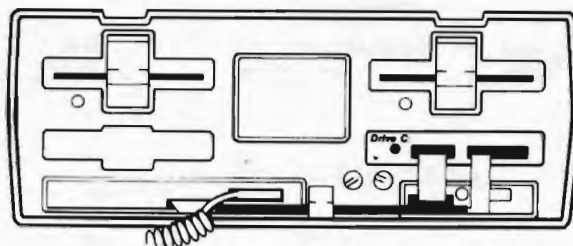

B:

WordStar Disk

AUTOST	.COM
INSTALL	.COM
MERGPRIN	.OVR
SAMPLE	.TXT
WS	.COM
WSMSGs	.OVR
WSOVLY1	.OVR
XDIR	.COM

A:

AUTOST	.COM	SAMPLE	.TXT
DCN	.COM	WS	.COM
DCU	.COM	WSMSGs	.OVR
Drive C:	.SYS	WSOVLY1	.OVR
INSTALL	.COM	XDIR	.COM
MERGPRIN	.OVR		

EXPLANATION: The System Status Illustration also lists the files on both Drive C and the floppy diskettes.

When a specific file or program is being emphasized, the System Status Illustration may show only that file rather than a complete listing.

TYPING YOUR INPUTS

ALL user inputs in the manual are shown CAPITALIZED. It is NOT necessary for you to capitalize your inputs. Drive C software will accept both upper- and lower-case inputs.

How To Use This Manual



1-3 Drive C FEATURES

Drive C is an integrated hardware and software enhancement designed specifically for your Osborne 1. Drive C not only dramatically improves performance and adds new capabilities...it actually improves the way you use your Osborne 1.

RAM-disk

Your Osborne 1 has two floppy disk drives. The Drive C RAM-disk acts as a third logical drive, drive C:. It is called a logical drive because, to your Osborne, Drive C looks just like your floppy disk drives. Therefore, you can use Drive C EXACTLY as you use floppy drives A: and B:.

While floppy disk drives are slow, noisy and prone to mechanical failure, Drive C is fully electronic, silent and has no moving parts.

It can find information stored on it up to 20 times faster than a floppy disk drive. As a result, you will experience a dramatic improvement in program performance.

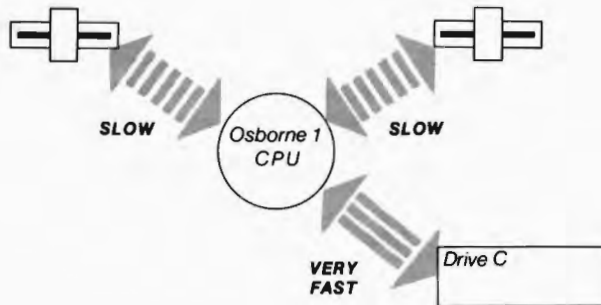

*The Drive C RAM-disk is the third logical drive.
It accesses information and communicates with your Osborne much faster
than your floppy disk drives.*

This increase in disk speed dramatically affects the way many programs respond. WordStar frequently stops and starts as the floppy disk drives slowly access files. With Drive C, WordStar works smoothly without lengthy disk interruptions and a writer can, for the first time, write in a very natural way.

Drive C also adds additional on-line storage capacity. More programs and data can be stored on your Osborne. This feature eliminates constantly changing diskettes.

For example, you can easily have WordStar, SuperCalc, text and data files on Drive C and still have additional programs on your floppy diskettes. Large, complex programs like dBase II requiring many different files that work together, can now be resident on your Osborne at the same time.



How To Use This Manual

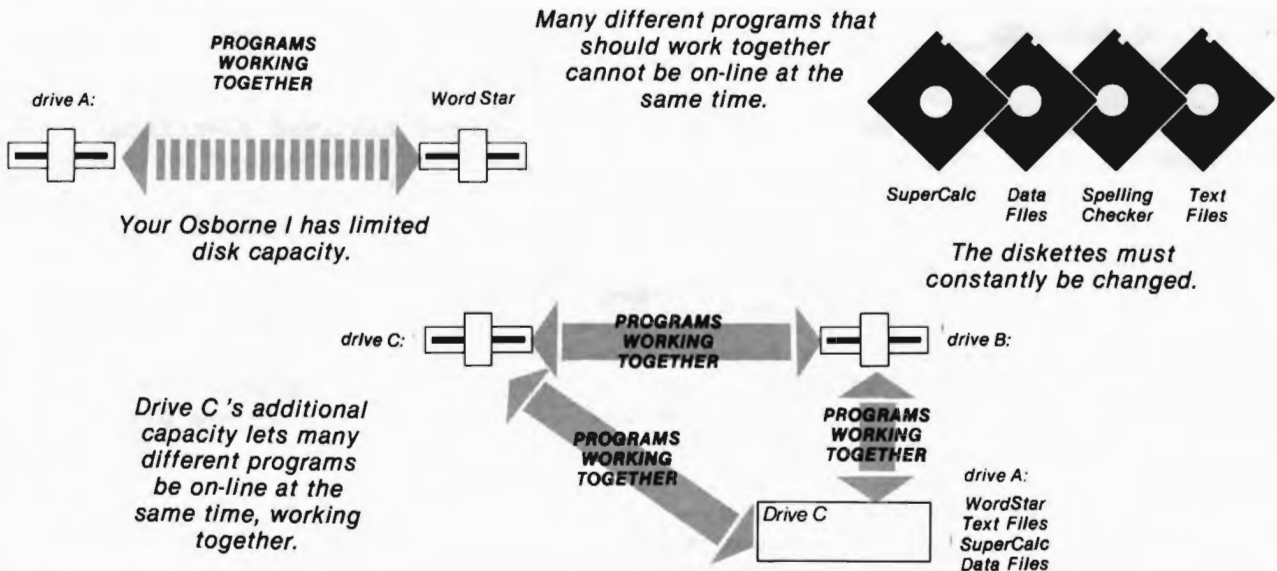

The Drive C RAM-disk acts as one big logical disk drive. As a result, its full capacity can be used for one large file.

Programs, documents and databases can be built on the 384K Drive C that are twice as big as those created on double-density floppy disks and four times the size of those on single-density disks.

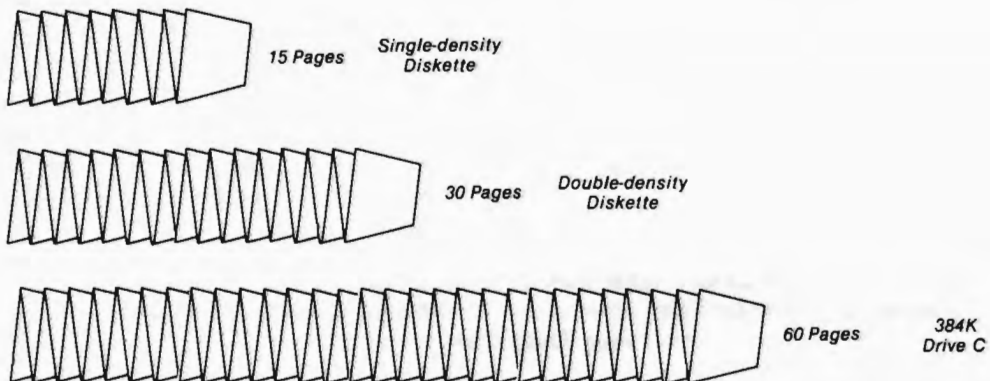

Very big programs, documents and data bases can be created on your Drive C .

Files this large are not possible on your floppy disks.

While Drive C acts like a floppy disk drive, it does not use actual diskettes. Files must be moved to and from Drive C using file copying programs like PIP, Sweep or WordStar. Once files are copied onto Drive C, they will remain there until you turn the power off, **EVEN IF YOU PRESS THE RESET BUTTON.**

The names of your floppy disk drives can be changed even though 'A' and 'B' are embossed on the Osborne front panel. Drive C software allows you to rename both Drive C and the floppy disk drives. The Drive C RAM-disk, for instance, should be renamed to drive A: in order to run WordStar.

How To Use This Manual



The red drive indicator light on the front of Drive C works just like the red LEDs on your floppy disk drives to let you know when the Drive C unit is active.

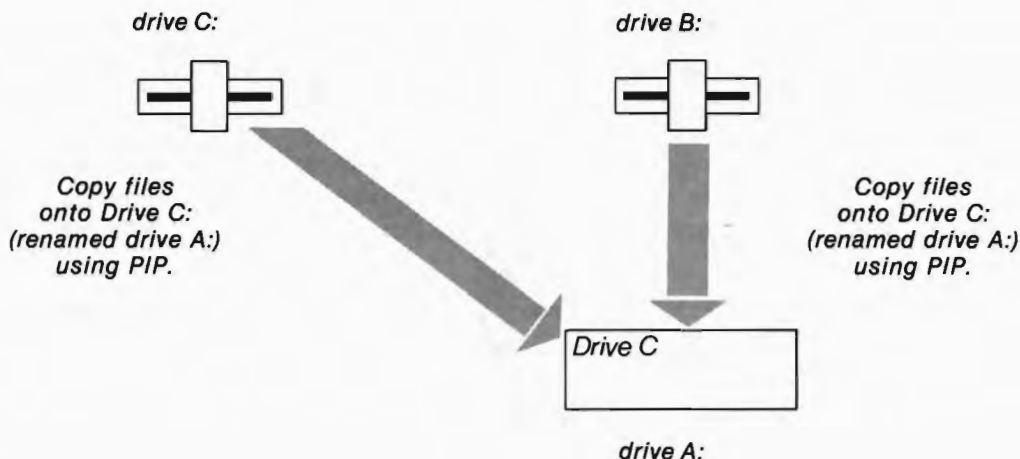

ARCHIVE AND RETRIEVE

When your Osborne is turned off, Drive C will no longer be powered and files in Drive C will be lost. Files on Drive C should be saved (backed up) on floppy disk before turning your Osborne off. This can be done using PIP or file copying options in programs like WordStar.

ARCHIVE (DCA.COM) automatically stores any or all of the files from Drive C onto floppy diskettes. Files on Drive C that are larger than a single floppy diskette can be stored on a set of diskettes. ARCHIVE also labels and organizes each backup set.

RETRIEVE automatically reloads and reconstructs the original Drive C files from your Archival backup set.

BackPac, the optional Drive C power supply/battery backup system, fits in your keyboard. BackPac maintains the contents of Drive C even if the Osborne is turned off. Adding BackPac gives Drive C permanent storage capability, in essence letting Drive C act as an ultra-fast hard disk.

No electrical or mechanical modifications of your Osborne are necessary with BackPac.



How To Use This Manual

Backup (copy) individual Drive C files onto floppy diskettes using PIP.

Drive C

The maximum size of stored files is limited by the capacity of your floppy diskette

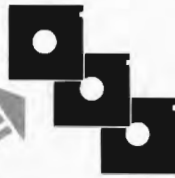

Backup files as large as 376K onto a set of diskettes using Archive.

Drive C

Reload and reconstruct the original contents of Drive C using Retrieve.

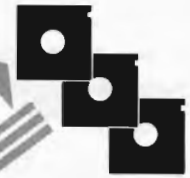

BackPac supplies continuous power to Drive C

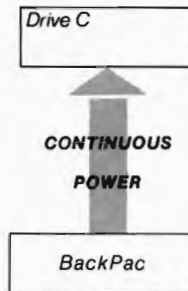

Files are retained even when your Osborne is turned off.

PRINT BUFFER

The Drive C Print Buffer lets you use your Osborne while simultaneously printing files. Once installed, Print Buffer operation is automatic.

Your printer normally ties up your Osborne until it has completed printing a file. The Print Buffer stores the print output from your Osborne at high speed and quickly returns control of your Osborne to you. You may continue to run programs while the Print Buffer automatically sends the print output to the printer.

THE PRINT BUFFER WORKS WITH BOTH RS-232 SERIAL AND CENTRONICS PARALLEL PRINTERS.

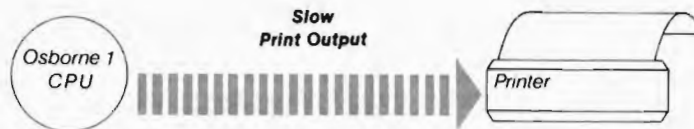

Your Osborne is tied up until printing is completed.

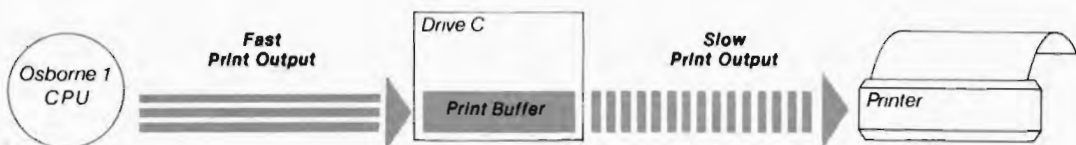

The Print Buffer quickly stores the print output.

Your Osborne can be used for computing while the Print Buffer is printing.

How To Use This Manual



The Drive C unit is partitioned by its software into a RAM-disk space and a Print Buffer space.

You can partition the Drive C for Print Buffer use in two different ways:

The **FIXED BUFFER** is a space on Drive C that is reserved solely for Print Buffer use. Eight Fixed Buffer sizes are available, from 16K to 128K.

The **DYNAMIC BUFFER** uses any space on the Drive C which is not being used as RAM-disk space. As you add or delete files from the RAM-disk, the Dynamic Buffer automatically increases or decreases in size. Up to the full capacity of the Drive C can be used as the Print Buffer using the Dynamic Buffer option.

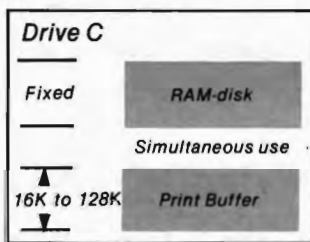

FIXED BUFFER

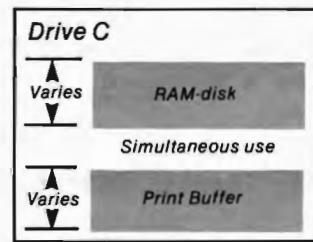

DYNAMIC BUFFER

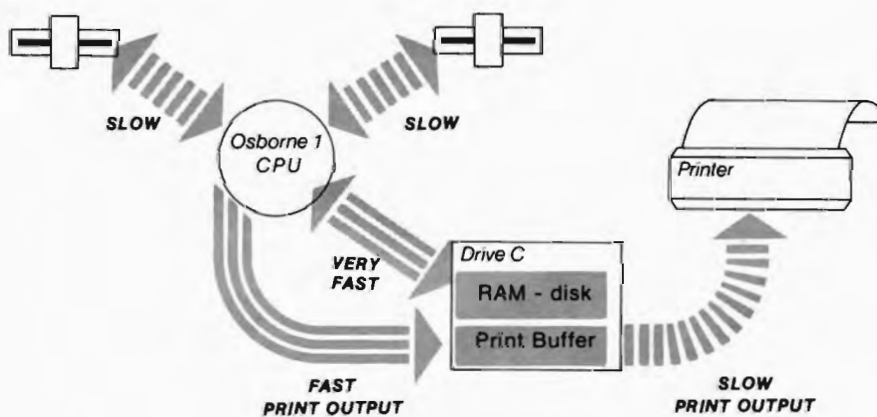

You can queue any number of files to be printed from both floppy disks and the RAM-disk. Files to be printed are stacked in the Print Buffer and will be printed in first-come, first-served order.



How To Use This Manual

The Drive C Utility program (DCU.COM) gives you a number of helpful tools to use with the Print Buffer. With DCU you can determine and optimize the space available for the Dynamic Buffer. You can also pause, restart and clear the Print Buffer.

QUICKPAC

QuickPac makes using Drive C even easier. A single keystroke starts QuickPac. QuickPac installs Drive C, renames Drive C and installs your choice of Print Buffers. It can also copy the contents of one or both of your floppy disks to Drive C and automatically run a program.

The QuickPac Installation program is an easy-to-use, menu-selection program that lets you choose from the various QuickPac options.

TURBOPAC

TurboPac is the powerful Drive C/Trantor hard disk system. TurboPac software turns your Drive C into a hi-speed Cache Buffer for the Trantor hard disk.

TurboPac automatically keeps your most frequently used programs and data in the Drive C Cache Buffer, increasing the hard disk throughput by as much as five times.

The 192K TurboPac system uses all of Drive C as a Cache Buffer. The 384K TurboPac system partitions Drive C into a 256K Cache Buffer and a 128K Fixed Print Buffer.

The hard disk attaches to the Drive C PRINTER/HARD DISK/8088 port and no mechanical modifications are necessary.

Drive C can still be used for portable operation by detaching the hard disk and using the normal Drive C RAM-disk/Print Buffer software.

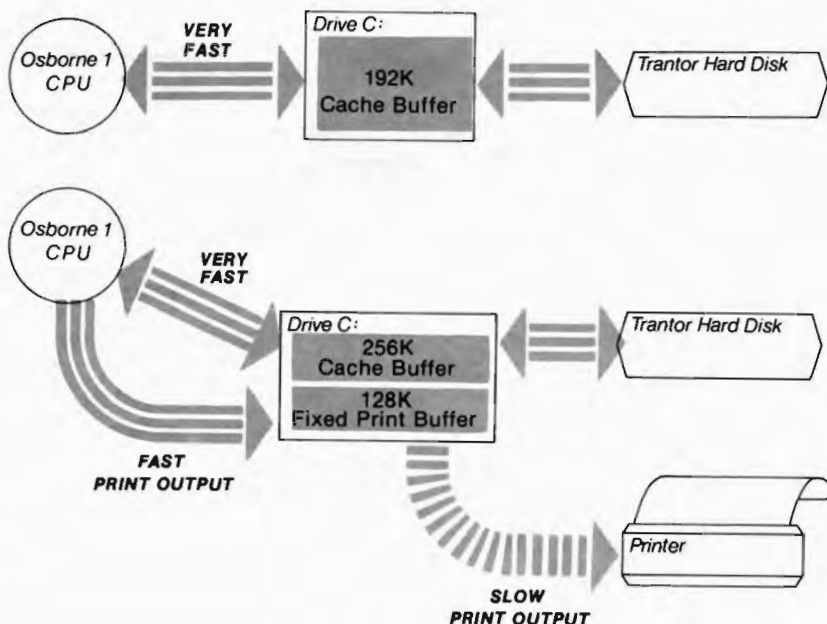

Getting Started



CONTENTS

- 2-1 MECHANICAL INSTALLATION OF Drive C
- 2-2 REMOVING THE Drive C UNIT
- 2-3 USING DISPLAY SCREENS WITH Drive C
- 2-4 MAKING YOUR COPY OF THE Drive C SOFTWARE
- 2-5 FOR USERS OF REV 1.2 Ols
- 2-6 TESTING YOUR Drive C INSTALLATION
- 2-7 TROUBLE-SHOOTING THE Drive C INSTALLATION
- 2-8 INSTALLING Drive C WITH YOUR PRINTER
- 2-9 TROUBLE-SHOOTING THE PARALLEL PRINTER INSTALLATION
- 2-10 COPYING YOUR CP/M ONTO THE DC USER DISK
- 2-11 TESTING YOUR PRINTER OPERATION
- 2-12 TROUBLE-SHOOTING YOUR PRINTER, PART 2
- 2-13 QUICK CHECKLIST OF Drive C INSTALLATION

2-1 MECHANICAL INSTALLATION

**** DO NOT INSTALL YOUR Drive C UNIT YET ****

Housed in a stainless steel case, Drive C is a rugged, solid state device which fits snugly into the right-hand floppy diskette storage pocket of the Osborne 1.

Drive C has been designed specifically for your Osborne 1. It generates very little heat and needs no maintenance. Installation does not require any electrical or mechanical modifications to your Osborne nor are any special tools required.

Two cables attach Drive C to the Osborne. One cable plugs into the Ext. Video edge connector. The other cable plugs into the IEEE-488 edge connector. You can think of these cables as "extension cords".

The Drive C edge connectors located at the end of the "extension cord" cables duplicate the Osborne Ext. Video and IEEE-488 edge connectors. You don't lose the use of your Osborne connectors by adding Drive C.



Getting Started

For instance, if your parallel printer was normally connected to the Osborne IEEE-488 connector, you would instead connect it to the new edge connector at the end of the "extension cord" cable on the Drive C, labeled PRINTER/HARD DISK/8088.

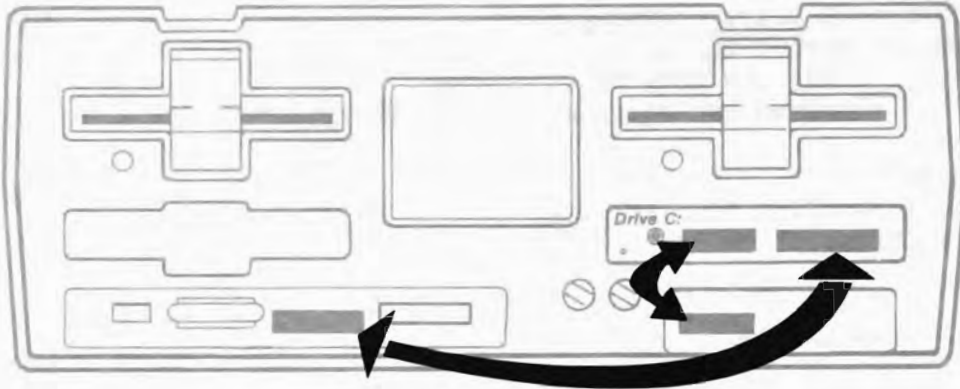

CABLE ADJUSTMENT

Drive C works with both brown and blue case Osborne 1's. There are minor mechanical differences between these machines, but Drive C's design compensates for these differences.

The Drive C "Extension Cord" cables reach down from the right-hand floppy diskette pocket to the IEEE-488 and Ext. Video edge connectors on the Osborne 1. The distance from the right diskette pocket to the edge connectors is different on Brown and Blue case Osborne 1s.

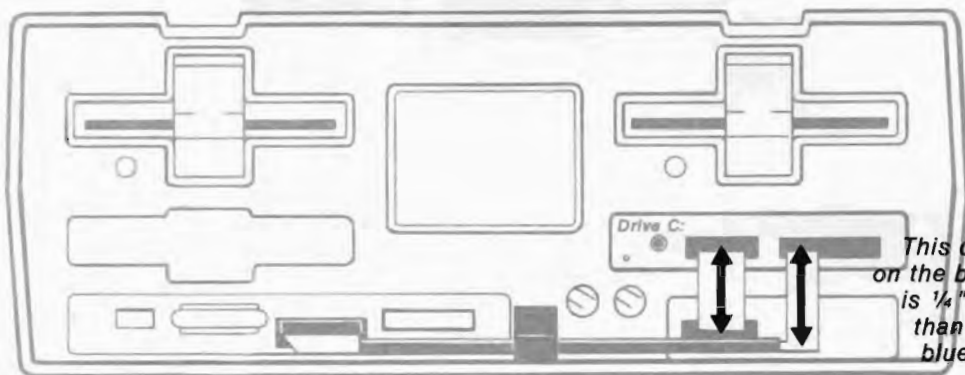

This distance on the brown case is $\frac{1}{4}$ " greater than on the blue case.

IEEE 488

Ext. Video

Getting Started



TO PROPERLY ADJUST YOUR CABLE LENGTHS, VIEW YOUR Drive C FROM ITS FOAM COVERED BOTTOM SIDE AND FOLD THE CABLES AS SHOWN.

BROWN CASE

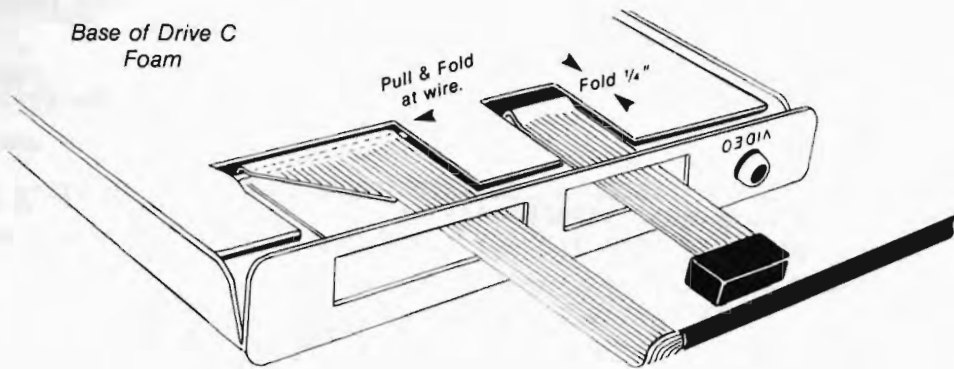

BLUE CASE

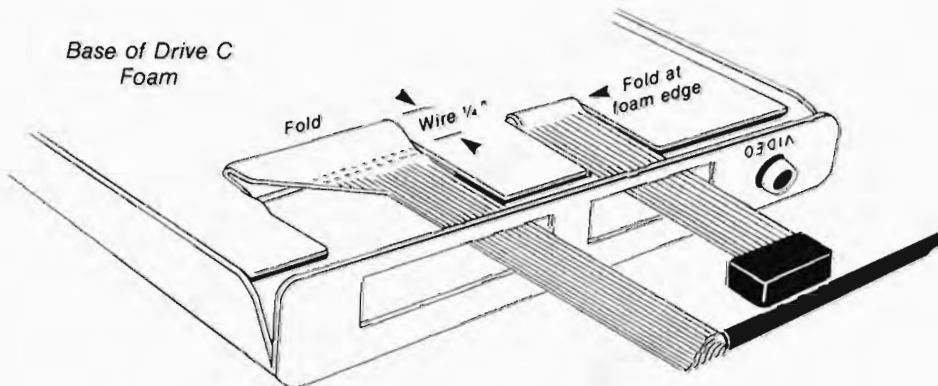



Getting Started

BROWN CASE POCKET HEIGHT ADJUSTMENT

For owners of BROWN CASE 01s only (NOT for BLUE CASE OWNERS)

The height of the floppy diskette storage pocket varies widely among brown case Osborne 1s.

Two self-adhesive bumpers are enclosed with your Drive C unit. Attached to the top surface of your Drive C, they provide a snug fit regardless of the height of your Osborne's pocket.

Please peel the protective covering from each bumper and attach as follows:

ONE BUMPER SHOULD BE PLACED ALONG EACH UPPER EDGE OF YOUR Drive C UNIT

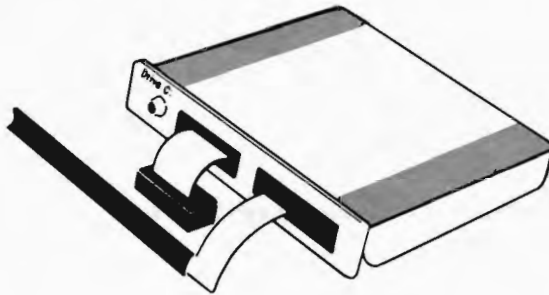

THE BUMPERS MUST BE ADJUSTED FOR THE HEIGHT OF YOUR POCKET

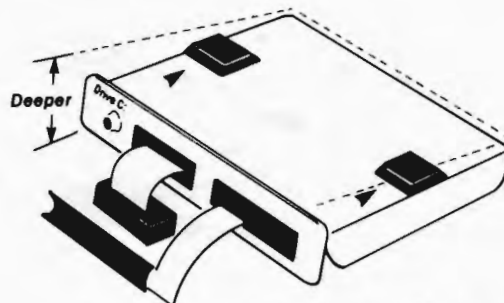

Locate the bumpers toward the rear for deeper pockets.

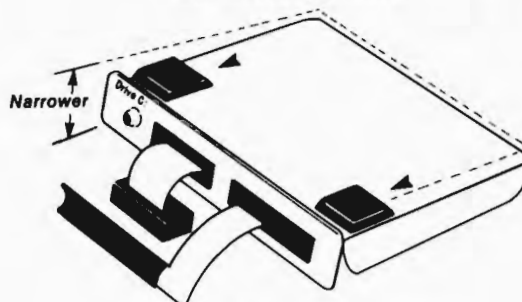

Locate the bumpers forward for narrower pockets.

Getting Started



Drive C UNIT INSTALLATION

**** MAKE SURE YOUR OSBORNE IS TURNED OFF ****

Slide the Drive C unit into the right-hand floppy diskette storage pocket until the Drive C front panel is seated flush with the Osborne 1 front panel.

Connect the short 20-conductor VIDEO "Extension Cord" cable from the Drive C to the Osborne 1 Ext. Video edge connector.

Connect the long 26-conductor IEEE-488 "Extension Cord" cable from the Drive C to the Osborne 1 IEEE-488 edge connector. The IEEE-488 cable should fit between the RESET button and the BATTERY connector.

Enclosed with your Drive C is a self-adhesive plastic cable clamp for the IEEE-488 cable. Remove the protective covering and install the cable clamp between the O1 front panel Keyboard connector and the Brightness control knob. This clamp will conveniently keep the Drive C signal cable in its proper position.

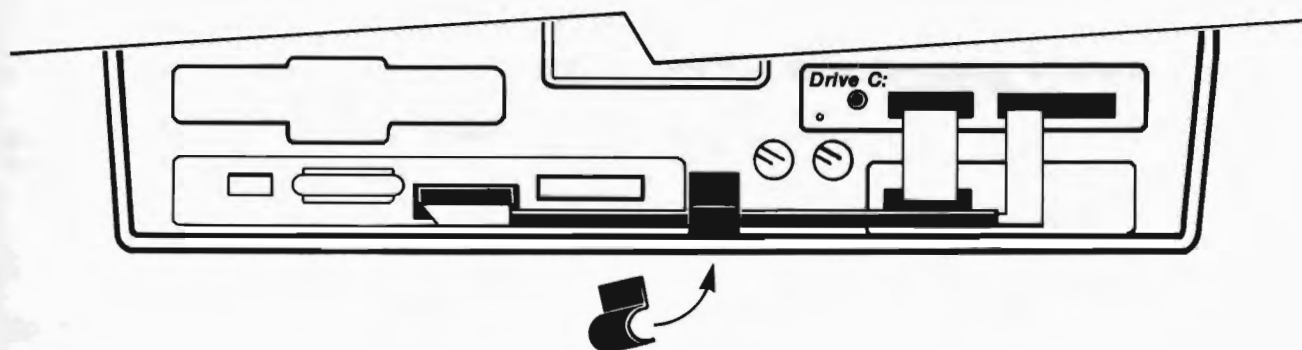



Getting Started

2-2 REMOVING THE Drive C UNIT

To remove your Drive C unit, please follow these steps:

REMOVE the black cable clamp from the Osborne front panel and store for future use.

DETACH the long cable from the Osborne IEEE-488 edge connector. Use pliers (channel lock pliers work best) to gently pull the black connector body at the Osborne end of the cable. DO NOT PULL ON THE CABLE ITSELF.

DETACH the short cable from the Osborne Ext. Video edge connector. Use pliers to gently pull the black connector body at the Osborne end of the cable. DO NOT PULL ON THE CABLE ITSELF.

GENTLY, so you won't mar either Drive C or your Osborne, pry the front panel of the Drive C unit out from the floppy diskette storage pocket. Use a small screwdriver as a lever until the Drive C unit is about 1/4 inch out of the pocket. Continue pulling out the Drive C unit by hand, grasping the front panel between the two "extension cord" cables.

Getting Started



2-3 USING DISPLAY SCREENS WITH Drive C

EXT. VIDEO/BATTERY PORT

The Drive C EXT. VIDEO/BATTERY edge connector above the short "extension cord" cable is an exact duplicate of the Osborne Ext. Video edge connector.

TO USE YOUR OSBORNE INTERNAL MONITOR

Your 5" internal monitor is enabled by attaching the black VIDEO SHORTING PLUG supplied with your Osborne. This plug has a label which says, "DO NOT REMOVE WHILE POWER IS ON".

When the Video Shorting Plug is plugged onto the Drive C EXT. VIDEO/BATTERY edge connector, video signals are directed to your internal monitor. With the Video Shorting Plug installed on your Drive C, your Osborne keyboard can be attached and the case closed without interference.

Please, DO NOT INSERT OR REMOVE the Video Shorting Plug with power ON.

TO USE THE OSBORNE EXTERNAL MONITOR WITH 52-COLUMN DISPLAY

Attach the cable from the Brown Osborne external monitor to the Drive C EXT. VIDEO/BATTERY edge connector.

TO USE EXTERNAL VIDEO MONITORS WITH 52-COLUMN DISPLAY.

Commercial external video monitors require composite video signals. If you have a composite video monitor then you've been using an adapter connected to your Osborne Ext. Video edge connector. Drive C has its own built-in video adapter and your adapter IS NO LONGER NECESSARY.

The VIDEO jack on the front panel of the Drive C unit provides composite video signals for your external monitor. These signals are always available regardless of whether the Video Shorting Plug is installed or not.

Attach the cable from your external composite video monitor to the RCA VIDEO jack. Turn the CONTRAST control on your Osborne 1 all the way UP, and re-adjust the BRIGHTNESS control on your 01 (if you are using the internal display) to your taste.

You may have to readjust the BRIGHTNESS, CONTRAST and HORIZONTAL SYNC controls on your external display to get a clear picture centered in the screen.

If you use an external monitor and DO NOT want your internal monitor on, DO NOT install the Video Shorting Plug on Drive C.

If you use an external monitor and want BOTH the external and internal monitors on, DO install the Video Shorting Plug on Drive C.



Getting Started

TO USE 80-COLUMN DISPLAYS

If you have an 80-column display Adapter (such as Osborne's ScreenPac) installed, **DO NOT** attach your external monitor cable to the Drive C VIDEO jack. Continue to use the 80-column composite video RCA jack supplied with your 80-column upgrade.

Osborne 80-column upgrades require the Video Shorting Plug to be installed on the Drive C EXT. VIDEO/BATTERY edge connector.

Drive C works with all 80-column upgrades made by independent manufacturers that **DO NOT** use the IEEE-488 port. Follow the manufacturers instructions and use the new 80-column RCA jack provided with the upgrade. If any connections to the Osborne Ext. Video connection were required, use the Drive C EXT. VIDEO/BATTERY connector instead.

TO USE THE OSBORNE EXTERNAL MONITOR WITH 80-COLUMN DISPLAY

If you have an Osborne external monitor with the special 80-column adapter, attach the adapter to the Drive C EXT. VIDEO/BATTERY edge connector and the cable to the 80-column RCA jack.

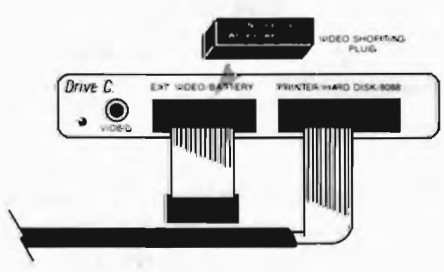

Internal Monitor

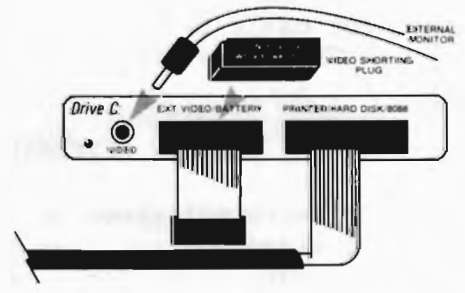

External Monitor - 52 Column

Video Shorting Plug (Optional)

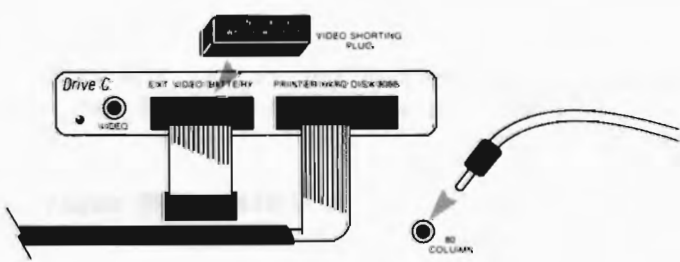

External Monitor - 80 Column

Video Shorting Plug (Optional)

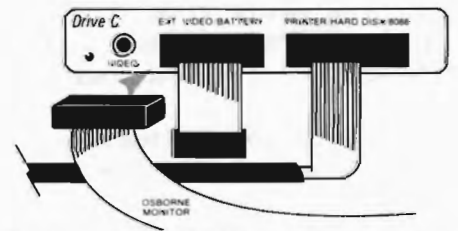

Osborne External Monitor - 52 Column

Getting Started



2-4 MAKING YOUR USER COPY OF THE Drive C SOFTWARE

First we'll cover how to check your Drive C LOADER & ARCHIVE DISK using XDIR to make sure it contains the correct files.

Turn ON power to your computer.

If either your internal or external display is not just right, please return to the previous Section, 2-3, to make sure you have connected and adjusted your display(s) correctly.

*** IMPORTANT ***

NOTE the Rev Number displayed in the rectangular box after turning on power but before loading CP/M. This number is two or three digits ranging from Rev 1.2 to Rev 1.44.

You will need a blank diskette and a copy of your Osborne CP/M System and Utilities diskette for the this Section.

Please label the blank diskette DC USER DISK.

Single density 01's sometimes have two CP/M System disks, one labeled CP/M SYSTEM DISK and the other labeled CP/M UTILITY DISK. Use the one called the SYSTEM DISK.

DO NOT REMOVE THE WRITE PROTECT TAB FROM YOUR ORIGINAL Drive C LOADER & ARCHIVE DISK!

Insert your CP/M system disk in drive A: and the Drive C LOADER & ARCHIVE DISK in drive B:.

CP/M SYS DISK

ASM	.COM
AUTOST	.COM
COPY	.COM
DDT	.COM
DUMP	.COM
ED	.COM
HELP	.COM
LOAD	.COM
MOVCPM	.COM
PIP	.COM
SETUP	.COM
STAT	.COM
SUBMIT	.COM
SYSGEN	.COM
XDIR	.COM
XSUB	.COM

A:

B:

LOADER & ARCHIVE

AUTOST	.COM
DCA	.COM
DCL	.COM
DCQ	.COM
DCQ	.DAT
DCQAUT	.COM
DCQINS	.COM
DCU	.COM
DFD	.SPR
PIP	.COM
PRN	.TST
XDIR	.COM

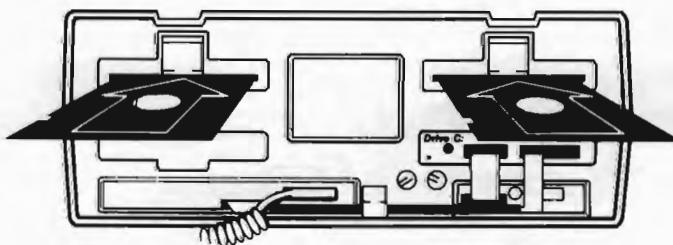

Drive C NOT INSTALLED



Getting Started

Press <CR> to load CP/M. The A> should appear on your screen.

If you have AutoStart on your CP/M Systems and Utilities diskette, a menu will appear on your screen. Press <ESC> to get the A>.

```
A>XDIR B:<CR>
```

Run XDIR from A: to check B:

You should see the following screen:

```
Extended Directory version _._
```

```
AUTOST .COM 2K
DCA .COM 10K
DCL .COM 8K
DCQ .COM 2K
DCQ .DAT 2K
DCQAUT .COM 2K
DCQINS .COM 8K
DCU .COM 8K
DFD .SPR 4K
PIP .COM 8K
PRN .TST 8K
XDIR .COM 4K
```

```
Disk B: 2k blocks
```

```
Size= 92K, 12 Files, Used= 68K, Space= 24K
```

If your LOADER & ARCHIVE DISK is DIFFERENT from this display (except for the version number of XDIR, which will vary) please write or call Drive C for assistance.

Next, we'll explain how to copy the Drive C LOADER & ARCHIVE diskette using COPY.COM. Type the Copy command as shown:

```
A>COPY<CR>
```

Run COPY from A:

```
Select source drive for copy (A or B)
or press RETURN for main menu B
```

Remove the CP/M SYSTEM DISK from drive A:.

CP/M SYS DISK

A:

B:

LOADER & ARCHIVE

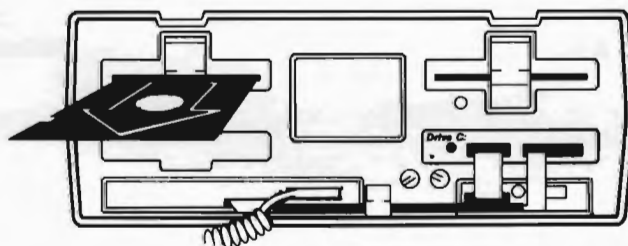

Getting Started



Insert the DC USER DISK in drive A:.

DC USER DISK

A:

B:

LOADER & ARCHIVE

Blank

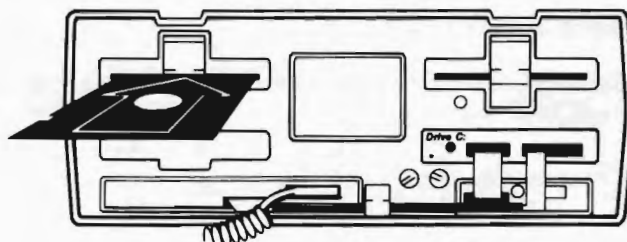

Drive C NOT INSTALLED

Select the COPY option which copies All of the diskette (including the System Tracks) FROM drive B: TO drive A:,

**Place SOURCE diskette in drive B
DESTINATION diskette in drive A
and press RETURN when ready <CR>**

BE CAREFUL NOT to press <CR> when COPY asks if you want to copy another disk or to return to CP/M. If you do press <CR> at that point you will probably get a boot error later with this DC USER DISK.

DO NOT SYSGEN OR WRITE PROTECT YOUR DC USER DISK!

Remove your LOADER & ARCHIVE DISK and save it in a safe place for future reference.

DC USER DISK

A:

B:

LOADER & ARCHIVE

AUTOST .COM
DCA .COM
DCL .COM
DCQ .COM
DCQ .DAT
DCQAUT .COM
DCQINS .COM
DCU .COM
DFD .SPR
PIP .COM
PRN .TST
XDIR .COM

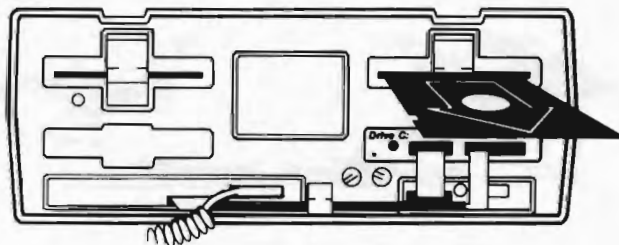

Press the [RESET] button.



Getting Started

2-5 FOR USERS OF REV 1.2 O1s ONLY

If you have a single density computer AND the Rev Number (the number in the rectangular box after power up or Reset) of your O1 is 1.2, then you MUST put CP/M onto your DC USER DISK next.

If your O1's Rev Number is any other number (such as 1.3 or 1.44) please skip this step and proceed to Section 2-6.

Remove the DC USER DISK from drive A:.

DC USER DISK

A:

B:

NO Diskette

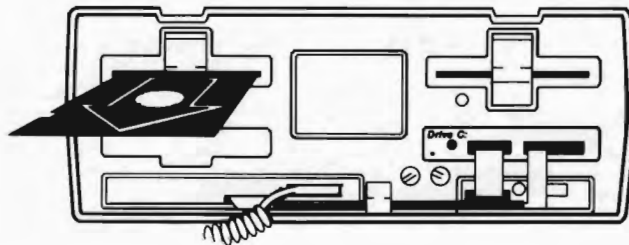

Drive C NOT INSTALLED

Turn OFF power to your computer, then turn it back ON.

Put your CP/M System Disk in drive A: and your DC USER DISK in drive B:

CP/M SYS DISK

A:

B:

DC USER DISK

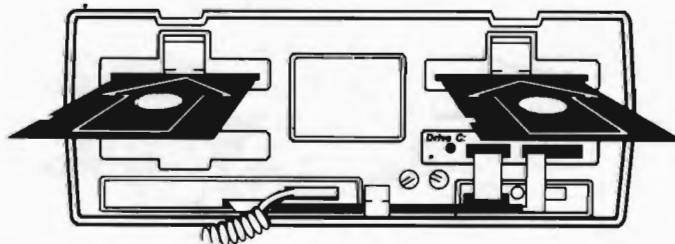

Drive C NOT INSTALLED

Getting Started



SECTION 2.5 ONLY FOR USERS OF REV 1.2 01s (continued)

Press <CR> and, if necessary, <ESC> to boot up to the A>.

```
A>SYSGEN<CR>
```

Run SYSGEN from drive A:

```
SOURCE drive (A or B) A<CR>
```

```
Put SOURCE diskette in drive A, then press RETURN <CR>  
System Read Successfully.
```

```
Put DESTINATION diskette in B, then press RETURN <CR>  
System Copied Successfully.
```

```
DESTINATION diskette (A B or RETURN to exit) <CR>
```

```
A>
```

The 'A' prompt

You will need to check the set up of your CP/M system so make sure the printer port is assigned correctly.

```
A>SETUP<CR>
```

Run SETUP from A: to check B:

```
Which Diskette do you want to configure  
Drive (A or B) B
```

You should check to make sure your system is setup as follows:

- A PRINTER CENTRONICS (Unless you have an RS-232 Serial printer)
- B BAUD RATE 1200 (assuming your Serial printer is set to 1200 baud.
 Baud rate has no effect on Centronics printer)
- C SCREEN 128 (or whatever size you usually use)
- D AUTO SCROLL ON
- E FUNCTION KEYS: have no effect on this test procedure, don't use them.
- F ARROW KEYS CP/M

Save the correct setup configuration onto the DC USER DISK in drive B:.



Getting Started

2-6 TESTING YOUR Drive C INSTALLATION

**** DO NOT INSTALL YOUR PARALLEL PRINTER CABLE YET ****

Just as you cannot use a program like WordStar until you have loaded it into your Osborne, you cannot use Drive C until you have installed (loaded) the Drive C software.

With our set of programs called QuickPac installing Drive C as a RAM-disk is very simple and requires only a single key stroke.

The DC USER DISK should be in drive A:.

DC USER DISK

A:

B:

NO Diskette

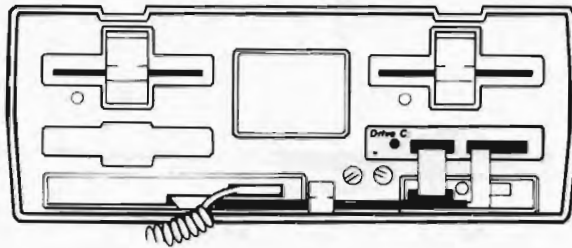

Drive C NOT INSTALLED

Press the [RESET] button.

Press <CR> to start QuickPac.

QuickPac will:

1. install the Drive C RAM-disk software
2. rename the Drive C unit to drive A: and the left-hand floppy to drive C:.
3. copy the contents of the DC USER DISK to the Drive C unit using PIP.
4. run XDIR on the Drive C unit, now renamed to drive A:

QuickPac displays messages as it is running. When the QuickPac operation is completed it will alert you with a beep and a message. The entire operation should take about one minute.

Getting Started



DC USER DISK

C:

B:

NO Diskette

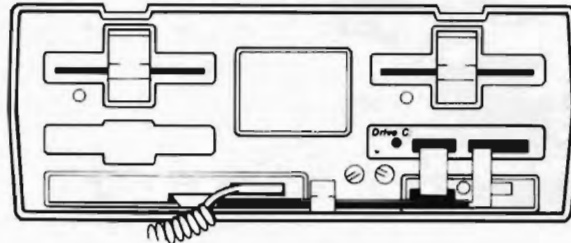

A:

DCA	.COM	DCU	.COM
DCLOADED	.SYS	Drive C:	.SYS
DCN	.COM	PIP	.COM
DCQAUT	.COM	PRN	.TST
DCQINS	.COM	XDIR	.COM

The Drive C RAM-disk should now be installed as a third logical drive, drive A:. You should see the following display:

IF YOU HAVE A 192K Drive C UNIT:

Extended Directory version _._

DCA	.COM	10K
DCLOADED	.SYS	0K
DCN	.COM	1K
DCQAUT	.COM	1K
DCQINS	.COM	8K
DCU	.COM	7K
Drive C:.	.SYS	0K
PIP	.COM	8K
PRN	.TST	8K
XDIR	.COM	3K

Disk A: 1k blocks

Size= 192K, 10 Files, Used= 51K, Space= 141K



Getting Started

IF YOU HAVE A 384K Drive C UNIT:

Extended Directory version _._

DCA	.COM	10K
DCLOADED	.SYS	0K
DCN	.COM	2K
DCQAUT	.COM	2K
DCQINS	.COM	8K
DCU	.COM	8K
Drive C:.	.SYS	0K
PIP	.COM	8K
PRN	.TST	8K
XDIR	.COM	4K

Disk A: 2k blocks

Size= 384K, 10 Files, Used= 58K, Space= 326K

If your screen shows the correct information, your Drive C is now successfully installed. Please continue to Section 2-8 to install and test your printer.

If your screen does NOT show the CORRECT information, please continue to the next Section, Trouble-shooting the Drive C Installation.

Getting Started



2-7 TROUBLE-SHOOTING THE Drive C INSTALLATION

Before trouble-shooting the RAM-disk installation, REMOVE the DC USER DISK from the floppy disk drive and turn the Osborne's power OFF.

1. Check that Drive C's EXT VIDEO and IEEE-488 cables are securely connected to the Osborne edge connector contacts.
2. If the contacts on your Osborne edge connectors are not clean, there may not be a reliable electrical connection between Drive C and your Osborne.

Gently wipe the contacts clean, using a cotton swab slightly wetted with rubbing alcohol.

3. Osbornes with silver colored (solder coated) edge contacts can become contaminated with time. This can be a source of continuing electrical problems with both Drive C and printer cables. Gold-plated replacement contacts are commercially available to remedy this problem.
4. YOUR CENTRONICS-STYLE PRINTER CABLE SHOULD NOT BE CONNECTED DURING INITIAL RAM-disk INSTALLATION AND TEST. Disconnect it if it was connected and run the installation tests again.
5. Make sure that the test was run with the DC USER DISK.
6. If you have a single density O1 with Rev Number 1.2, make sure that you put CP/M on your DC USER DISK using SYSGEN as detailed in Section 2-5.
7. Make sure your DC USER DISK is NOT write protected with a tab.
8. If you are re-running the DC USER DISK QuickPac test:

First: ALWAYS REMOVE the DC USER DISK and turn OFF the O1 power,

Second: Wait five seconds,

Third: Turn power back ON,

Fourth: Put the DC USER DISK in drive A:

THEN: Press <CR> to restart QuickPac.

If re-running the test still doesn't work, you should start over by recopying the Drive C LOADER & ARCHIVE Disk onto your DC USER DISK step by step.



Getting Started

2-8 INSTALLING Drive C WITH YOUR PRINTER

IF YOU HAVE A SERIAL PRINTER

Skip this Section and Section 2-9 which cover installing and trouble-shooting Centronics printers and go to Section 2-10, Putting your CP/M on the DC USER DISK.

IF YOU HAVE A CENTRONICS PARALLEL PRINTER

**** DO NOT ATTACH YOUR PRINTER CABLE YET ****

Installing your parallel printer with Drive C requires no special software or hardware. Printers and printer cables, however, are very individualized products, often eccentric in their design and even cantankerous in their performance. This Section will guide you through the installation of your printer with Drive C to make sure that it is working properly. The Print Buffer will not be installed yet.

Your parallel printer is normally attached to the IEEE-488 edge connector on your Osborne. The PRINTER/HARD DISK/8088 edge connector on the Drive C duplicates the parallel port function of the Osborne IEEE-488 port. To use your parallel printer with Drive C, your printer cable will be connected to the Drive C PRINTER/HARD DISK/8088 connector instead of the Osborne IEEE-488 connector.

**** IEEE-488 COMMUNICATIONS PROTOCOL IS NOT SUPPORTED ****
ON THE Drive C PRINTER/HARD DISK/8088 EDGE CONNECTOR

Incorrectly wired cables may interfere with Drive C operation. This Section will test your cable and explain how to easily fix it if it is incorrectly wired.

Most Centronics parallel printers change the electrical conditions of the cable when they are turned OFF, causing problems for the Drive C unit similar to those caused by incorrectly wired cables.

YOUR CENTRONICS-SYLE PRINTER SHOULD ALWAYS BE ON FOR PROPER Drive C OPERATION IF ITS CABLE IS PLUGGED INTO THE Drive C. Neither your printer nor Drive C will be harmed by keeping your printer turned ON during Drive C use.

Also, the printer cable should be attached to or removed from the PRINTER/HARD DISK/8088 port on the Drive C unit ONLY when your O1 computer's power is OFF.

Getting Started



INSTALLING YOUR CENTRONICS PARALLEL PRINTER CABLE

Remove the DC USER DISK and turn the O1 power OFF.

DC USER DISK

A:

B:

NO DISK

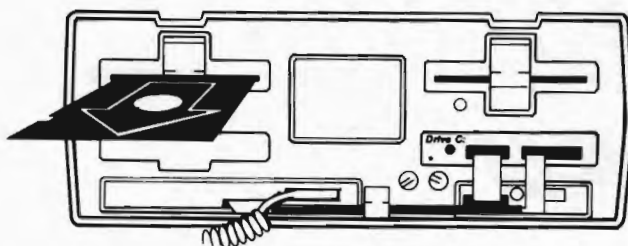

Drive C NOT INSTALLED

Attach the parallel printer cable to the PRINTER/HARD DISK/8088 edge connector. Connect it in the same way it was connected to the Osborne IEEE-488 port, i.e. with the pin 1 of the cable to the right.

Turn ON the power to your printer.

Turn ON the power to your Osborne 1 and put the DC USER DISK back in drive A:.

DC USER DISK

A:

B:

NO DISK

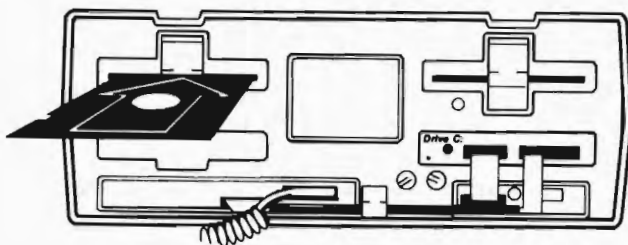

Drive C NOT INSTALLED

Press <CR> to run QuickPac again. You should see the same sequence of events as before when you loaded QuickPac without the printer.

If QuickPac completed its operation exactly as before, then skip the next Section and proceed to Section 2-10, Putting your CP/M on the DC USER DISK. Actual printer operation will be tested in Section 2-11.

If your QuickPac test did not function exactly as before, or the QuickPac XDIR display gave different information about the files on the Drive C unit, please proceed to the next Section, Trouble shooting the Parallel Printer Installation.



Getting Started

2-9 TROUBLESHOOTING THE PARALLEL PRINTER INSTALLATION

1. Remove the DC USER DISK and turn the Osborne power OFF. This will clear the results of the previous test.

DC USER DISK

A:

B:

NO Diskette

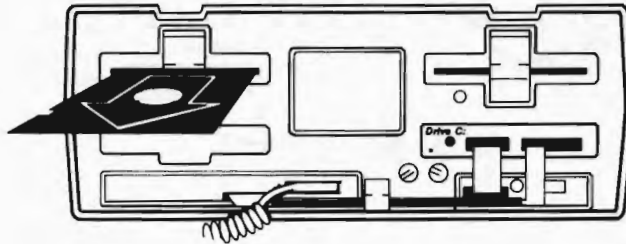

Drive C NOT INSTALLED

2. If you tested your parallel printer installation with the printer OFF, please try it again with the printer power ON.
3. Make sure your printer cable is firmly plugged into the Drive C PRINTER/HARD DISK/8088 port edge connector, AND into the printer.
4. Make sure your printer is ON-LINE (selected).
5. If you have SYSGEN'd the DC USER DISK for Rev Number 1.2 computers as we instructed in Section 2-5, please check the disk's setup by using your copy of SETUP.COM (as explained in Section 2-5). Make sure the disk is set up for Centronics printer, NOT serial or IEEE-488.
6. Drive C works correctly with all Osborne-standard parallel printer cables. Some parallel printer cables do not conform to standard Osborne specifications and have an extra unnecessary wire. If you have such a cable, both your printer AND Drive C will not work correctly.

An incorrectly wired cable is a VERY COMMON problem. To check your parallel printer cable, open the housing at the PRINTER END of the cable. The housing can usually be opened with a screwdriver or popped open with your fingernails.

There should NOT be a connection to pin 12 on the 36-pin connector at the printer end of the cable. If there is a wire attached to pin 12, it must be disconnected.

Disconnecting this wire has no effect on your printer when used either with OR without Drive C.

DO NOT MAKE ANY MODIFICATIONS TO THE OSBORNE END OF YOUR PRINTER CABLE.

Getting Started

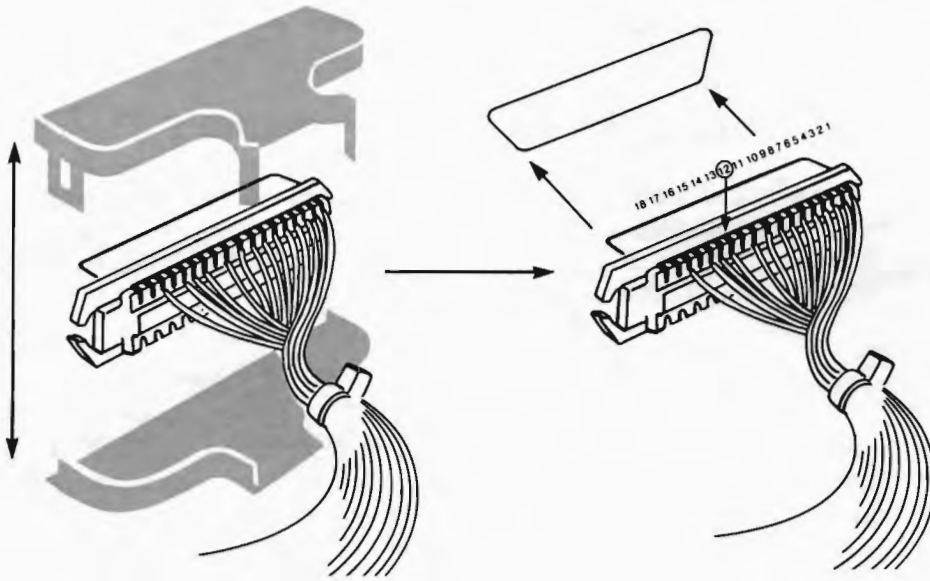

7. Replace the cable housing and turn the Osborne power ON.
8. GO BACK TO SECTION 2-8 AND RERUN THE QuickPac TEST.
9. If you still do not get the proper results, call Drive C for assistance.



Getting Started

2-10 COPYING YOUR CP/M ONTO THE DC USER DISK

IF YOU HAVE A REV NUMBER 1.2 OSBORNE 1

If you have a Rev Number 1.2 Osborne 1 you should have already copied CP/M onto your DC USER DISK back in Section 2-5. If you have not, go back to 2-5. DO NOT USE THIS SECTION. If you copied CP/M in Section 2-5, PLEASE SKIP THIS SECTION and go to Section 2-11, Testing Your Printer Operation.

IF YOU HAVE A REV NUMBER 1.3 - 1.44 OSBORNE 1

Before trying the next test you will need to copy CP/M from one of the disks you normally use to boot up onto the DC USER DISK. For this operation you'll use the SYSGEN and SETUP utilities. Your versions of these two programs may give a slightly different display from that shown below, but the procedure to follow is the same.

Remove the DC USER DISK and turn the O1 power OFF.

DC USER DISK

A:

B:

NO Diskette

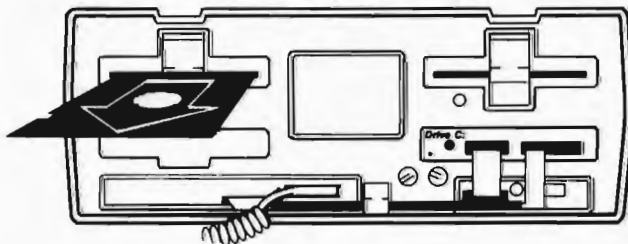

Drive C NOT INSTALLED

Turn ON the power to your Osborne 1. Put the CP/M SYS DISK in drive A: and the DC USER DISK back in drive B:.

CP/M SYS DISK

A:

B:

DC USER DISK

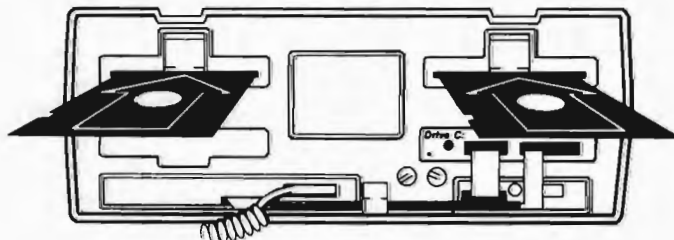

Drive C NOT INSTALLED

Getting Started



Press the [RESET] button.

Press <CR> (and, if necessary, <ESC>) to boot up CP/M and get the A>.

A>SYSGEN<CR>

Run SYSGEN from A: (get system from B:)

SOURCE drive (A or B) A

Put SOURCE diskette in drive A, then press RETURN <CR>

System read successfully.

DESTINATION (A,B or RETURN to exit) B

Put DESTINATION diskette in B, then press RETURN <CR>

System copied successfully.

DESTINATION (A,B or RETURN to exit) <CR>

A>

'A' prompt



Getting Started

You now need to check the setup of your CP/M system on the DC USER DISK to make sure the printer port is assigned correctly.

A>SETUP<CR>

Run SETUP from A: to check B:

**Select source diskette for configuration (A or B)
or press "M" to get system from memory. B**

You should check to make sure your system is set up as follows:

- A PRINTER CENTRONICS (or SERIAL if you have an RS-232 Serial printer)
- B BAUD RATE 1200 (assuming your Serial printer is set to 1200 baud.
Baud rate has no effect on Centronics printer)
- C SCREEN 128 (or whatever size you usually use)
- D AUTO SCROLL ON (or OFF if you are using OCC's ScreenPac)
- E FUNCTION KEYS: have no effect on this test procedure, don't use them.
- F ARROW KEYS CP/M (or WORDSTAR if you prefer)

If you have changed the setup please BE SURE TO SAVE THE NEW SETUP ONTO drive B:.
When you have finished checking and saving your setup press CR> to exit to CP/M.

A>

'A' prompt

Remove the CP/M SYSTEM DISK from drive A: and insert the DC USER DISK in drive A:.

DC USER DISK

A:

B:

NO Diskette

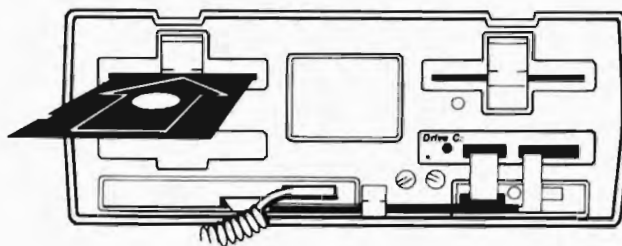

Drive C NOT INSTALLED

Getting Started



2-11 TESTING YOUR PRINTER OPERATION

Now let's make sure your printer (whether Centronics parallel or RS-232 Serial) works properly with Drive C.

Make sure:

1. that your printer is ON
2. its cable is connected properly
3. the printer has at least SIX continuous pages of paper
4. it's ready to print (on-line)

DC USER DISK

A:

B:

NO Diskette

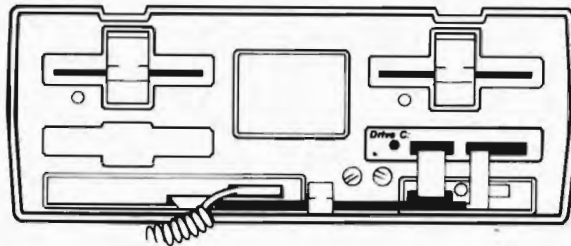

Drive C NOT INSTALLED

Press the [RESET] button.

Press <CR> to start QuickPac.

After QuickPac runs XDIR (as before in Sections 2-6 and/or 2-8) and gives you the CP/M A> prompt, proceed as follows:

To see exactly what the print output should look like, display the file PRN.TST on your screen by typing this command:

```
A>TYPE PRN.TST<CR>
```

Display file PRN.TST on screen.

You should see a pattern repeating over and over. The beginning seven lines of this pattern are shown below:

```
Drive C: PRINTER TEST
Drive C: PRINTER TEST a
Drive C: PRINTER TEST ab
Drive C: PRINTER TEST abc
Drive C: PRINTER TEST abcd
Drive C: PRINTER TEST abcde
Drive C: PRINTER TEST abcdef
```



Getting Started

To actually print the test file, type this command:

```
A>PIP LST:=PRN.TST<CR>
```

Print PRN.TST using PIP

Your printer should now be printing the same pattern you previously saw onscreen with the TYPE command.

The PRN.TST file contains approximately three pages of this test pattern.

If you can print even a few lines your installation is working just fine and you can stop the test if you want to.

To STOP the print test: Type ^C to clear PIP back to the CP/M A>.

NOTE: we are not using the Drive C Print Buffer feature for this test, so you will not see the next A> prompt until the file is completely printed or until you stop the test with ^C. If your printer has an internal buffer or if you are using an external print buffer box, the printer may keep printing for a while after the computer has finished sending characters to the buffer.

IF YOUR SYSTEM HAD PROBLEMS PRINTING PRN.TST

If you had problems printing PRN.TST go on to Section 2-12, Trouble-shooting your printer, Part 2.

IF YOUR SYSTEM PASSED THE TESTS

If your system successfully passed all the tests so far, you're ALMOST done with installation!

```
A>ERA C:AUTOST.COM<CR>
```

Erase AUTOST.COM from C: (DC USER DISK)

DC USER DISK

C:

B:

NO Diskette

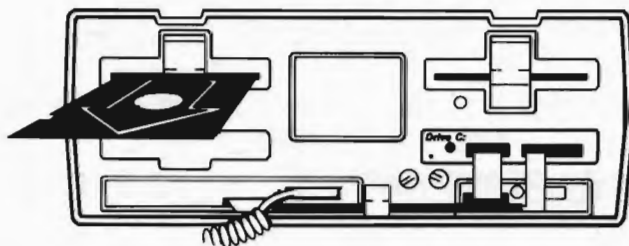

A:

Please remove the DC USER DISK and turn OFF the O1 power.

Getting Started



2-12 TROUBLE-SHOOTING PRINTER OPERATION, PART 2

1. Please check that the DC USER DISK is properly configured for your printer (CENTRONICS or RS-232 Serial) using SETUP.COM. Check your DC USER DISK's setup against the list at the end of Section 2-10.
2. Check that your printer is on-line and has paper.
3. If you are re-running the DC USER DISK printer operation test:
First: ALWAYS REMOVE the DC USER DISK and turn OFF the O1 power,
Second: Wait five seconds,
Third: Turn power back ON,
Fourth: Insert the DC USER DISK in drive A: and press <CR> to rerun QuickPac.
THEN: Retype the PIP LST:=PRN.TST command to retry the test.
4. If you are still experiencing difficulties, please contact the Drive C Service Department for assistance. We will need to know the following if you call or write us to get help fixing your problem.
 - a. Is your O1 in a brown or blue case?
 - b. Is your O1 single- or double-density?
 - c. What is your O1's Rev Number (from the rectangular box on the screen)?
 - d. What is your Drive C serial number?
 - e. What size is your Drive C (192K or 384K)?

IF YOUR SYSTEM PASSED THE TESTS

If your system successfully passed all the tests so far, you're ALMOST done with installation!

```
A>ERA C:AUTOST.COM<CR>
```

Erase AUTOST.COM from C: (DC USER DISK)

DC USER DISK

C:

B:

NO Diskette

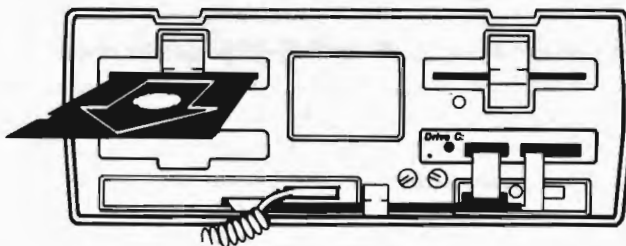

A:

Please remove the DC USER DISK and turn OFF the O1 power.



Getting Started

2-13 QUICK CHECKLIST OF Drive C INSTALLATION

This list is for your convenience if you are already thoroughly familiar with your computer and CP/M. Please don't use this checklist in place of the step-by-step installation guide.

The procedures in Section 2 were developed to GUARANTEE a satisfactory Drive C installation EVERY TIME. To make trouble-shooting easier, this checklist refers to specific detailed parts of Section 2.

- Step 1. Adjust Drive C cable lengths to fit your computer [Section 2-1]
- Step 2. Mechanically install your Drive C unit [Section 2-1]
- Step 3. Reconnect cables and Video Shorting Plug to your display [Section 2-3]
- Step 4. Check files on Drive C ARCHIVE & LOADER Disk supplied with your unit [Section 2-4]
- Step 5. Copy LOADER & ARCHIVE Disk to DC USER Disk [Section 2-4]
- Step 6. [Only for ROM Number 1.2 single-density machines] SYSGEN your CP/M system onto DC USER Disk [Section 2-5]
- Step 7. Run QuickPac, i.e. Drive C's AUTOST.COM program which calls DCQ.COM, DCQ.DAT, PIP.COM and XDIR.COM, to test Drive C installation. [Section 2-6]
If you have problems here, trouble-shoot with [Section 2-7]
- Step 8. If you have a Centronics parallel printer, turn off power, reconnect your printer cable, rerun QuickPac [Section 2-8]
If you have problems here, trouble-shoot with [Section 2-9]
- Step 9. Put your version of CP/M onto DC USER Disk using SYSGEN [Section 2-10]
- Step 10. Check the setup of your DC USER DISK using SETUP.COM [Section 2-10]
- Step 11. Test your entire installation by printing PRN.TST from the Drive C unit using PIP.COM and your version of CP/M [Section 2-11]
If you have problems here, trouble-shoot with [Section 2-12]

The Trouble-shooting Sections (2-7, 2-9 and 2-12) were written to give you the ability to easily correct the most common installation problems.

If you run into trouble, make sure you go through the detailed installation procedure step-by-step. 99 times out of 100 you can fix just about any problem you might encounter very quickly without calling Drive C for help.

Fitting Drive C To Your Needs



CONTENTS

- 3-1 THE AUTOMATIC APPROACH
- 3-2 THE MANUAL APPROACH
- 3-3 USING IT BOTH WAYS

Your Drive C software is very comprehensive. It has been designed for Osborne owners of all levels of experience, from the first time enthusiast to the professional programmer. If you are a beginner, you'll find it easy to understand and simple to use. If you're an old pro, you'll find it versatile and powerful.

Similarly, your Drive C can enhance any application. This section is a brief overview of how the different Drive C software features can be used. As you learn about your Drive C in the rest of the manual, you might keep in mind which features best fit your needs.

3-1 THE AUTOMATIC APPROACH

QuickPac is the easiest way to use your Drive C. The QuickPac program can install ALL of the Drive C features, copy files from one or both of the floppy diskettes in your disk drives onto Drive C and run a program simply by pressing the <RETURN> key.

If you are a relatively new user we suggest you use QuickPac. The QuickPac Installation program is menu-driven and requires no technical knowledge. It lets you configure QuickPac to automatically install Drive C with the features you need each time you start your Osborne.

QuickPac has the unique feature of remembering if it has copied files onto your Drive C so that if you press the RESET button, QuickPac will re-install the Drive C features you've chosen (like a new drive name or the Print Buffer) without recopying files.

If you're a more experienced user who does the same procedures on a regular basis (like loading your accounting or data base program each day), you'll find it very convenient to setup and use QuickPac to automatically configure your system. The QuickPac Installation program creates a data file which QuickPac uses to find out which Drive C options you want to install (for instance, what program to run).

If you routinely use several programs, you can create a different QuickPac setup for each diskette set. As an example, one QuickPac setup might rename Drive C to drive A:, copy WordStar and your document files onto your Drive C unit and run WordStar automatically. A different QuickPac setup might copy your accounting data files onto Drive C and run your General Ledger program from your floppy disk.

Finally, if you're an experienced Osborne owner working with an inexperienced user (for instance, a new employee), you might want to setup QuickPac to automatically configure your system for frequently required jobs.



Fitting Drive C To Your Needs

3-2 THE MANUAL APPROACH

The Drive C commands have a very simple structure. ALL the Drive C features can be installed manually with a one-line statement (maximum length - 9 characters plus <RETURN>). If you do many different operations with your Osborne or if you are a programmer, you'll probably find it more convenient to use Drive C manually.

Because the Drive C commands are simple and short, you can put many alternate Drive C commands on your function keys. For instance, one function key might install Drive C as drive A: with the Dynamic Print Buffer. A second function key might install Drive C as drive C: with a 16K Fixed Print Buffer.

THE DCA program (ARCHIVE and RETRIEVE) can store and reconstruct the contents of Drive C, including files larger than the capacity of a floppy disk. DCA is also much faster than the standard QuickPac file copy function, which uses PIP.

Storing commonly used sets of files onto an Archive diskette set can be a very efficient way to use Drive C. The RETRIEVE portion of DCA can be used automatically so that a single function key will load an Archive set onto Drive C quickly. You could, for example, make one function key give the command: DCA R B<CR> which retrieves the contents of the Archive set in drive B: onto the Drive C unit.

Fitting Drive C To Your Needs



3-3 USING IT BOTH WAYS

Finally, the most powerful way to use your Drive C is with a combination of techniques. QuickPac can be started manually by using the DCQAUT command rather than Autostart. By creating different QuickPac data files for different diskette sets, you can use QuickPac with your function keys to easily perform complex routines when you need them.

The remote RETRIEVE command, DCA R B, can be run automatically as part of QuickPac so that a single function key can start QuickPac and rapidly load new files onto Drive C using RETRIEVE and Archive sets.

QuickPac can also be custom configured much like a complex Submit file. Instructions for creating custom QuickPac setups are included in the appendices.

If you are an experienced user, the combination of function keys, QuickPac and DCA (ARCHIVE and RETRIEVE) will offer you almost unlimited flexibility for using Drive C with your Osborne 1.



CP/M Tutorial

CONTENTS

- 4-1 OPERATING SYSTEMS
- 4-2 FORMATTING DISKS
- 4-3 PUTTING CP/M ON DISKS USING SYSGEN
- 4-4 FILES AND DIR
- 4-5 XDIR
- 4-6 RENAMING FILES
- 4-7 COPYING FILES WITH PIP
- 4-8 ERASING FILES
- 4-9 CP/M ERROR MESSAGES

Many Osborne owners have successfully used their Osborne 1 without learning about CP/M, the Osborne 1's operating system.

If you've never learned to use PIP or DIR or ERA, the following is an easy-to-use tutorial for using CP/M.

It is essential that you become familiar with a few basic CP/M commands if you are to use your Drive C: efficiently and productively. This tutorial will guide you step-by-step through a number of these commands.

If you have a single-density Osborne, you will need a COPY of your CP/M System diskette. If you have a double-density Osborne, you will need a COPY of your CP/M System and Utility diskette.

This diskette will be referred to as the CP/M SYS DISK. The CP/M SYS DISK must NOT be Write Protected (it should NOT have a tab on it).

You will also need a new, UNformatted diskette. Please label the UNformatted diskette TEST DISK.

Your Drive C:, although mechanically installed, will not be used yet.

CP/M Tutorial



4-1 OPERATING SYSTEMS

Your computer is a combination of **HARDWARE** and **SOFTWARE**. The hardware is the Osborne 1 itself. Software are the programs that run on the hardware. The programs you use like WordStar are called **APPLICATION** programs. They perform the specific tasks you originally bought your Osborne for, like word processing.

Different computer manufacturers do not design their hardware exactly alike. The authors of software want their programs to run on as many kinds of computers without rewriting their programs for each specific machine.

A method was needed that allowed one version of a program to run on many different kinds of hardware.

Similarly, the manufacturers of peripheral equipment, like printers and monitors, want their products to work on many different kinds of computers.

A special kind of software has been developed to solve these problems. This special software is called the **OPERATING SYSTEM**.

Picture the operating system software as a buffer between the hardware on one side and the peripherals and application programs on the other.

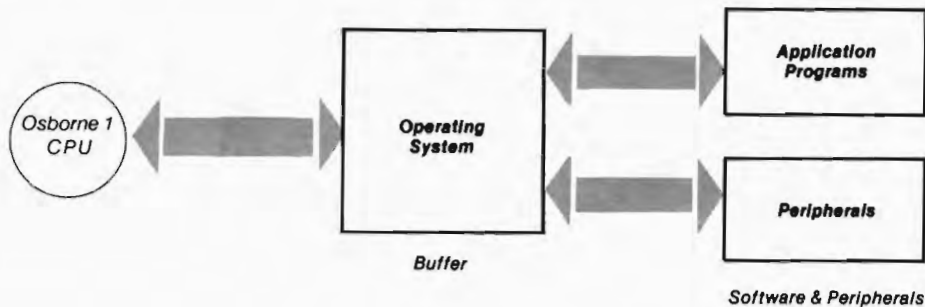

The side of the buffer that the peripherals and the application programs see always looks the same, regardless of the type of hardware.

The side of the buffer that talks to the hardware is adjusted by each manufacturer to work with his specific hardware.

The result is that many different brands of hardware using this operating system look **EXACTLY** alike to the people who write application programs and build peripheral equipment.



CP/M Tutorial

This buffer, the operating system, is obviously very useful. The operating system you have on your Osborne 1 is called CP/M and is used on many different machines. Because CP/M is so popular, a great number of application programs are available that will work on any CP/M equipped computer. Such a wide selection of software is a major advantage for the Osborne owner.

CP/M must be available so that your application program (like WordStar or SuperCalc) can work with your hardware, the O1. CP/M, however, is not permanently stored on your Osborne. Each time you turn power on or press the RESET button, CP/M must be reloaded into your Osborne.

After turning on your Osborne or pressing the RESET button, a message appears on your screen asking you to insert a diskette in drive A: and press <CR>. This message is permanently stored in the computer.

When you press <CR>, CP/M is loaded into your Osborne from the diskette in drive A:. The A> on the screen tells you that CP/M has been successfully loaded.

Your CP/M System and Utilities diskette is NOT the source of CP/M. It simply contains useful CP/M utility programs.

The CP/M operating system is stored in a reserved area on your diskettes called the SYSTEM TRACKS. Each of the application program diskettes (like WordStar) that came with your Osborne has CP/M already stored on its system tracks.

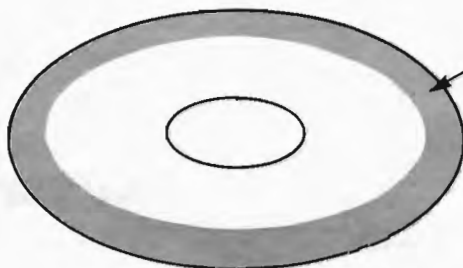

CP/M is stored on a reserved area on your diskette called the system tracks.

When CP/M is placed on a diskette, it is automatically located on the system tracks. Nothing else but CP/M can be put on the system tracks, so putting CP/M on a diskette does not waste precious disk data space.

ANY diskette can have CP/M on it and it is wise to put it on every diskette you use just after you have formatted it.



4-2 FORMATTING DISKS

A new, blank diskette must be formatted before your Osborne 1 can use it. Formatting prepares the diskette so that data can be written on it and read from it.

Press the [RESET] button.

CP/M SYS DISK

ASM	.COM
AUTOST	.COM
COPY	.COM
DDT	.COM
DUMP	.COM
ED	.COM
HELP	.COM
LOAD	.COM
MOVCPM	.COM
PIP	.COM
SETUP	.COM
STAT	.COM
SUBMIT	.COM
SYSGEN	.COM
XDIR	.COM
XSUB	.COM

A:

B:

TEST DISK

UNformatted

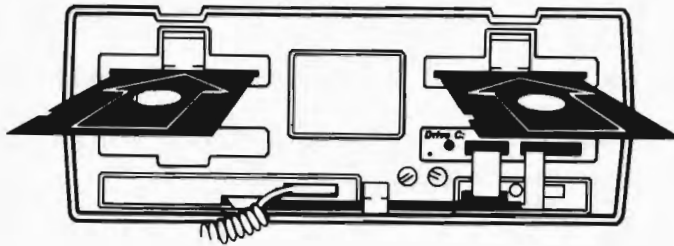

Press <CR> to load CP/M. The A> should appear on your screen.

If you have AutoStart on your CP/M Systems and Utilities diskette, the flying "O" will appear on your screen followed by a Help menu. Press <ESC> and the A> will appear on your screen.

A>

The 'A' prompt

The A> is called the 'A' prompt. A> means that your O1 will look for data and programs on drive A:.. You are LOGGED onto Drive A:.. Later, when you log onto drive B:, you'll see a B> on the screen to let you know that you're looking at drive B: instead of drive A:..



CP/M Tutorial

IF YOU HAVE A SINGLE-DENSITY 01:

A>FORMAT<CR>

Run FORMAT from A:

Follow the menus to format the diskette in B: Single-density.

IF YOU HAVE A DOUBLE-DENSITY 01:

A>COPY<CR>

Run COPY from A:

Follow the menus to format the diskette in B: Double-density.

This completes formatting. Any new diskette must be formatted before you use it.

You're now ready to use your formatted diskette for learning about CP/M.

NOTE: The "Copy Diskettes" option of COPY will automatically format a diskette but it will also transfer all of the files from one diskette to another whether you want them or not.

CP/M Tutorial



4-3 PUTTING CP/M ON DISKS USING SYSGEN

CP/M SYS DISK

SYSGEN .COM

A:

B:

TEST DISK

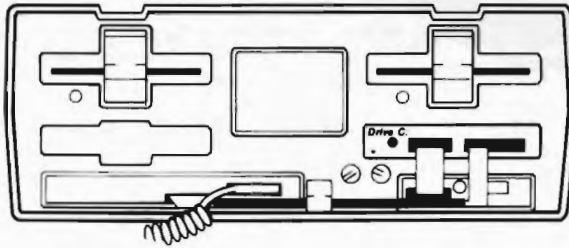

Formatted, blank
without CP/M

The SYSGEN program is used to place CP/M onto each diskette's system tracks. Sysgen makes a copy of CP/M from a diskette that already has CP/M on its system tracks. This copy of CP/M is stored in the Osborne memory and can then be put on the system tracks of a different diskette.

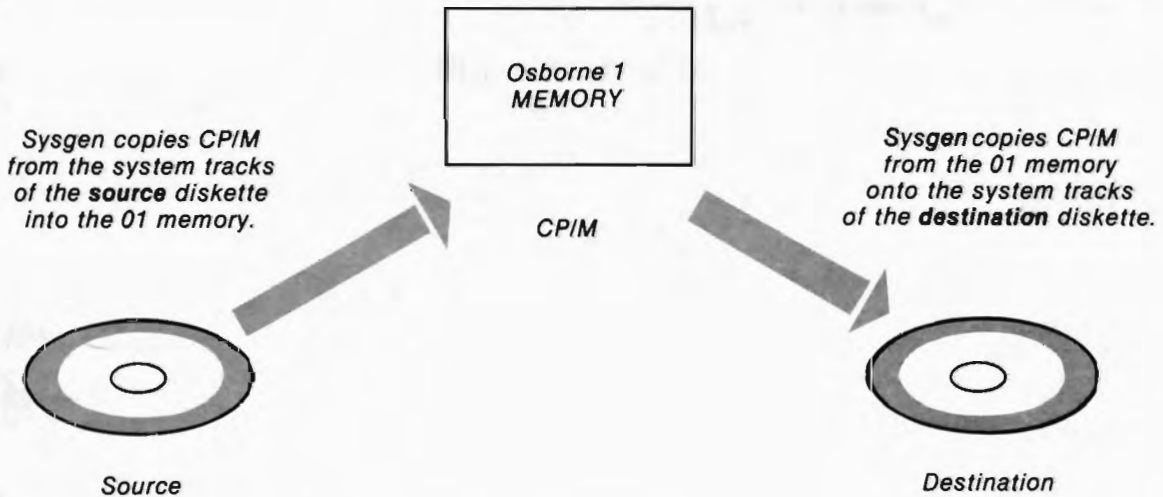



CP/M Tutorial

The A> ('A' prompt) is still on the screen so you can access any program on the CP/M System and Utilities diskette in drive A:.

A>SYSGEN<CR>

Run SYSGEN from A:

SOURCE drive (A or B) A

Put **SOURCE** diskette in drive A, then press **RETURN** <CR>
System read successfully.

This step loads CP/M into the Osborne memory from the system tracks on the diskette in drive A:.

DESTINATION (A,B or RETURN to exit) B

Put **DESTINATION** diskette in B, then press **RETURN** <CR>
System copied successfully.

This step copies CP/M from the Osborne memory onto the system tracks on the diskette in drive B:.

DESTINATION (A,B or RETURN to exit) <CR>

If you wanted to SYSGEN (it's also a verb) another diskette, you could now replace one of your diskettes and again direct CP/M from the Osborne memory to the new diskette by typing 'A' or 'B'.

Instead, press <CR> to terminate SYSGEN and the A> will appear, ready for your next instruction.

CP/M SYS DISK

A:

B:

TEST DISK

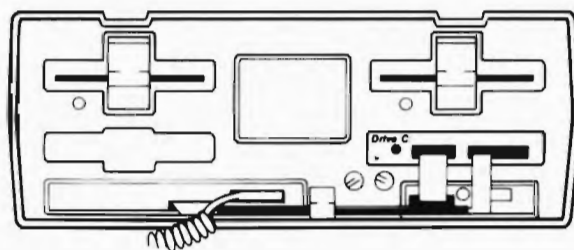

Formatted, blank
with CP/M

CP/M Tutorial



Press the [RESET] button.

Press " (QUOTATION MARKS) to load CP/M. The A> should appear on your screen.

Pressing the " (QUOTATION MARKS) instead of <CR> to load CP/M is an optional feature of your Osborne. It lets you load CP/M from the RIGHT-HAND floppy drive which is then named A: instead of the usual B:. This is useful if your LEFT-HAND drive is not working properly.

CP/M SYS DISK

B:

A:

TEST DISK

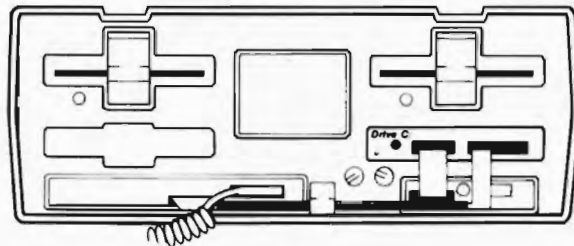

Formatted, blank with CP/M

ANY diskette that you prepared using SYSGEN will allow you to load CP/M into your Osborne. You don't have to (and SHOULD'N'T) use the master diskettes that Osborne Corp. supplied.

Press the [RESET] button.

Press <CR> to load CP/M. The A> should appear on your screen.

If you have AutoStart on your CP/M Systems and Utilities diskette, the flying "O" will appear on your screen followed by a Help menu. Press <ESC> and the A> will appear on your screen.

CP/M SYS DISK

A:

B:

TEST DISK

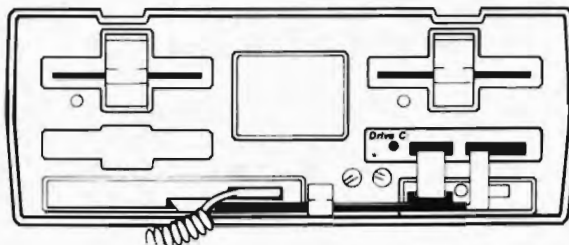

Formatted, blank with CP/M



CP/M Tutorial

4-4 FILES AND DIR

```
A>DIR<CR>
```

Run DIR from A: onto A:

A list of the files on the CP/M System and Utilities diskette in drive A: will appear on the screen. FILES are the different pieces of software on a diskette. Programs and data and WordStar documents are all files.

The files are listed in columns, with a file name (the FILE NAME) followed by (usually) another three letters (the FILE EXTENSION). DIR does NOT list the files alphabetically.

DIR is the built-in DIRECTORY command, a straightforward listing of the files on the diskette. Much can be learned by studying the DIR screen display.

The first thing to note is that there is no file in the listing called DIR. How did the Osborne know to respond to the command DIR?

DIR is automatically loaded and available when you load CP/M. Several other built-in commands like DIR will be explained in this tutorial.

There are a few simple CP/M rules regarding the file names on the DIR screen display. The necessary way to name a file is FILENAME.FILEEXTENSION. DIR doesn't show a period (.) between the FILE NAME and the FILE EXTENSION but any time you explicitly call a file (for instance, in WordStar) you must type it exactly (FILENAME.FILEEXTENSION).

The FILE NAME can be no more than eight letters long. The FILE EXTENSION that follows the name can be up to three letters in length.

The FILE EXTENSION tells the computer what kind of file it is. You can use these three letters to usefully organize different kinds of files on your diskette.

This tutorial is being drafted with WordStar and has the name CPMTUTOR.DOC (for DOCument). When WordStar saves this file, it automatically creates a copy of the file as it was previously, before editing. If a mistake exists in the current version, the previous version is still available for reference.

WordStar BACKS UP (makes a copy of the old version) and automatically names the original file CPMTUTOR.BAK (for BAcKup). Although there are now two files on the diskette named CPMTUTOR the Osborne has no difficulty telling them apart because one is a .DOC type file while the other is a .BAK type file.

Finally, you'll notice an A: before each file name. This means that the file is on the diskette in drive A: . CP/M always refers to the disk drive by the letter (in this case A) followed by a colon (:). When you want to tell your Osborne 1 to use a drive (LOG ON) or look for data on a drive, you name the drive with its letter followed by a colon.

CP/M Tutorial



When you typed DIR you did not refer to a drive name. CP/M assumes the drive name of the drive you are logged onto UNLESS you name a different drive. Right now you're logged onto drive A:. The A> below the directory tells you explicitly the name of the drive on which you're working.

```
A>B:<CR>
```

Log onto drive B:

```
B>
```

The B: prompt

The light will flash on the B: drive and the B> appears on the screen. You're now logged onto drive B:.

CP/M SYS DISK

A:

B:

TEST DISK

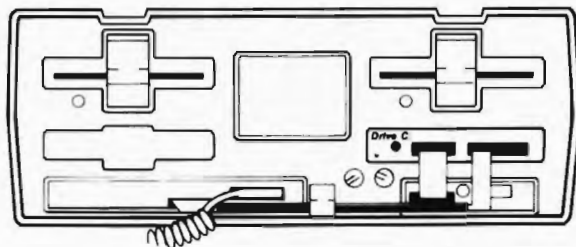

Formatted, blank with CP/M

```
B>DIR<CR>
```

Run DIR on B: from B:

```
NO FILE
```

No files are listed

```
B>
```

The B: prompt

DIR was run from drive B:. It listed the files on the blank diskette in drive B: since you were logged onto drive B: (the B>). Please note that DIR does NOT tell you whether CP/M is on the blank diskette's system tracks.

```
B>A:<CR>
```

Log onto drive A:

```
A>DIR<CR>
```

Run DIR on A: from A:

Again, by logging onto drive A: and running DIR, the directory of the logged on drive, A:, appears on the screen.

Using the drive designators A: and B: can dramatically improve your efficiency.

```
A>DIR B:<CR>
```

Run DIR on B: from A:

```
NO FILE
```

No files are listed

```
A>
```

The A: prompt

DIR was run from A: but directed to look at B:. This is a standard CP/M convention.



CP/M Tutorial

The general rule is:

THE PROGRAM NAME followed by a SPACE followed by the DRIVE NAME.

```
A>B:<CR>
```

Log onto B:

```
B>DIR A:<CR>
```

Run DIR on A: from B:

The directory of drive A: will appear on the screen even though you're logged onto B:.

Let's take a closer look at using the names of the files.

```
B>A:<CR>
```

Log onto A:

```
A>DIR S*.*<CR>
```

Run DIR on A: from A: only on files starting with 'S'

The directory displays only those files that start with the letter S.

The '*' (WILDCARD) is a simple but very powerful tool. You can use it to say "I don't care". In this case, you told your Osborne "Tell me about all the files on drive A: that start with the letter S. I don't care about any other letters in the FILE NAME and I don't care what kind of file it is (the FILE EXTENSION)." CP/M looks at the FILE NAMES and the FILE EXTENSIONS separately so you need two asterisks ('*'), one for each side of the period (.).

The '*' can help you organize your diskettes. You could name all your text files with a special FILE EXTENSION like .DOC for DOCument. To find the text files without searching through all the file names on the diskette, you would type the command: DIR *.DOC<CR>. The directory would show all the files with the FILE EXTENSION .DOC (the DOCument files) regardless of the FILE NAME.

CP/M Tutorial



4-5 XDIR

DIR is very useful and is 'free' since it doesn't occupy any diskette space. However, it lacks some features that would make it even more useful. A special directory program which has these extra features was supplied with your Osborne. This program is XDIR.COM, the EXTended Directory.

The FILE EXTENSION '.COM' in XDIR.COM means command. A command file is an application program. To use a .COM file, just type the FILE NAME and <CR> but do not type the FILE EXTENSION '.COM'.

CP/M SYS DISK

A:

B:

TEST DISK

XDIR .COM

Formatted, blank
with CP/M

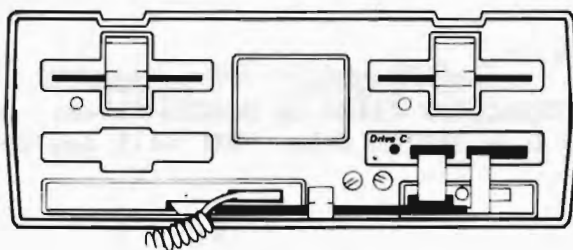

```
A>XDIR<CR>
```

Run XDIR from A:

XDIR lists the files alphabetically, a real help. It also provides information about the use of file space on the diskette. This feature is most important and is not provided by DIR.

XDIR provides the following information:

SIZE OF EACH FILE - Next to each file is a number followed by a 'K'. One 'K' equals 1024 bytes. This number tells you how much space each file occupies.

XDIR therefore tells you how large each file is. Since there is a limited amount of space on a diskette, the size is really telling you how much space the file occupies.

SIZE - At the bottom of your XDIR screen, the SIZE indicates how large your diskette is in K bytes.

Double-density diskettes are about twice as large as single-density diskettes. A 384K Drive C is exactly twice as large as a 192K Drive C.

USED - The total amount of space which is occupied by files plus the space occupied by the file directory itself is how much is already USED.

SPACE - The SPACE is how much usable space is left for additional files. SPACE always equals the SIZE of your diskette MINUS how much has already been USED.



CP/M Tutorial

The SPACE message is very important because it tells you how close you are to filling up your diskette.

```
A>XDIR B:<CR>
```

Run XDIR on B: from A:

Instead of the 'NO FILE' message that DIR gave, XDIR gives you general information even about a blank diskette.

Please note that XDIR, like DIR, can be directed to look at drive B: while you're logged onto drive A:.

```
A>XDIR S*.*<CR>
```

Run XDIR from A: on files starting with the letter S

The '*' (WILDCARD) works with XDIR to list just the files on drive A: that start with 'S'. XDIR always gives COMPLETE information about the diskette no matter what files you asked it to display.

CP/M files can be either DIRECTORY files or SYSTEM files. Drive C uses a special file, Drive C:.\SYS, which is a SYSTEM file. DIR will not show SYSTEM files. XDIR, however, will.

Finally, let's use XDIR as an example of another useful CP/M feature.

```
A>B:<CR>
```

Log onto B:

```
B>A:XDIR B:<CR>
```

While logged onto B:,
run XDIR on B: from A:

While logged onto drive B:, you ran a program (XDIR) on a different drive (A:) by first typing the name of the other drive (A:XDIR). This is a general CP/M rule and gives you even more flexibility.

```
B>A:<CR>
```

Log onto A:

CP/M Tutorial



4-6 RENAMING FILES

You can rename your files using the built-in CP/M command, REN (RENAME).

```
A>DIR C*.COM<CR>
```

Run DIR from A: on all .COM files that start with the letter C

CP/M SYS DISK

A:

B:

TEST DISK

COPY .COM

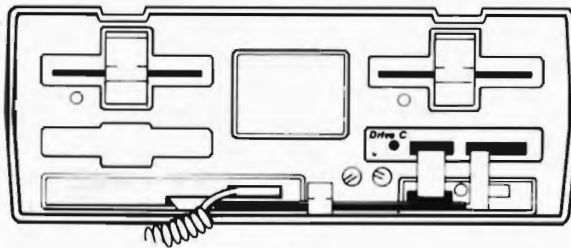

Formatted, blank with CP/M

The file COPY.COM is on the CP/M SYS DISK in A:.

```
A>REN NAMETEST.FIL=COPY.COM<CR>
```

Change the name COPY.COM to NAMETEST.FIL

```
A>DIR<CR>
```

Run DIR on A:

CP/M SYS DISK

A:

B:

TEST DISK

NAMETEST .FIL

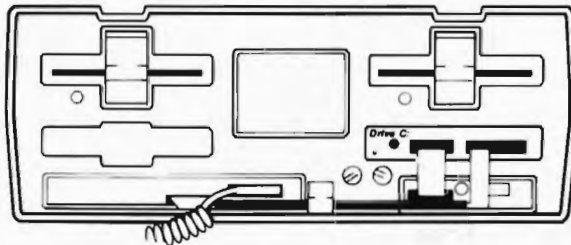

Formatted, blank with CP/M

The file COPY.COM has been renamed NAMETEST.FIL.

```
A>REN COPY.COM=NAMETEST.FIL<CR>
```

Change the name NAMETEST.FIL to COPY.COM

```
A>DIR<CR>
```

Run DIR on A:

When using REN, the name on the LEFT becomes the new name of the file on the RIGHT. You cannot, however, use the '*' (WILDCARD) with REN.



CP/M Tutorial

4-7 COPYING FILES WITH PIP

You've probably used COPY to copy files from one diskette to another. COPY can only copy ALL files rather than individual files and both the original and copy diskettes must be the same size (density).

```
A>XDIR<CR>
```

Run XDIR from A:

CP/M SYS DISK

A:

B:

TEST DISK

PIP .COM

Formatted, blank with CP/M

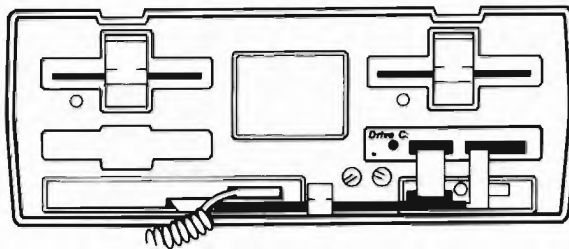

On your CP/M SYSTEMS DISK is a utility program called PIP.COM.

PIP can copy individual files and groups of files from one diskette to another. Since your disk space is limited, it's very helpful to be able to copy only those files that you need.

```
A>PIP B:=A:XDIR.COM[V<CR>
```

Copy XDIR.COM onto B: from A:

```
A>
```

'A' prompt

Your Drive Select lights will go on and your disk drives will whirr, just like when you COPY.

```
A>XDIR B:<CR>
```

Run XDIR on B: from A:

The diskette in drive B: is no longer blank. Somehow PIP placed a copy of the file XDIR.COM on the B: diskette.

CP/M SYS DISK

A:

B:

TEST DISK

XDIR .COM

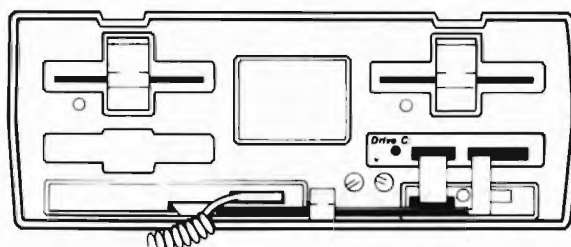

CP/M Tutorial



The PIP command at first glance appears very complicated. It isn't if you break it up into small parts.

THE PIP COMMAND: A>PIP B:=A:XDIR.COM[V<CR>

PIP	Since PIP.COM is a '.COM' file, it is used by typing its name, 'PIP'
B:	The drive where you want to 'put' the copy is always typed FIRST, on the LEFT.
A:	The drive you 'get' the copy is always typed SECOND, to the RIGHT
=	The '=' ALWAYS separates the SOURCE of the copy on the RIGHT and the DESTINATION for the copy on the LEFT
XDIR.COM	The name of the file to be copied. This must be EXACT.
[V	A phrase that should be added to the end of a PIP command to 'verify' that the copy is without mistakes

A>PIP B:=A:S*.*[V<CR>

Copy the files starting with 'S' onto B: from A:

A>XDIR B:<CR>

Run XDIR on B: from A:

CP/M SYS DISK

ASM	.COM
AUTOST	.COM
COPY	.COM
DDT	.COM
DUMP	.COM
ED	.COM
HELP	.COM
LOAD	.COM
MOVCPM	.COM
PIP	.COM
SETUP	.COM
STAT	.COM
SUBMIT	.COM
SYSGEN	.COM
XDIR	.COM
XSUB	.COM

A:

B:

TEST DISK

SETUP	.COM
STAT	.COM
SUBMIT	.COM
SYSGEN	.COM
XDIR	.COM

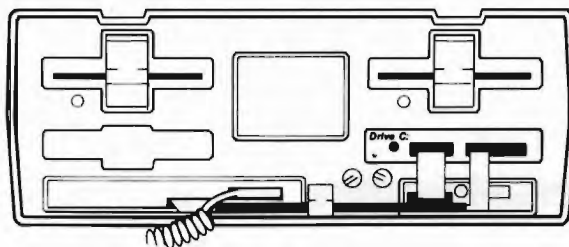



CP/M Tutorial

PIP can use the same '*' (WILDCARD) convention as XDIR. This command copied ALL files on A: that started with the letter 'S' onto B:.

```
A>PIP<CR>
```

Run PIP from A:

```
*
```

The PIP symbol

When just the name PIP is typed, the PIP prompt '*' appears on the next line. This '*' is not the same as the '*' (WILDCARD) which indicates "I don't care". Both '*'s can be used in the same line without confusion.

The PIP '*' is used so that you do not have to constantly load PIP to copy a series of files. As long as the PIP '*' is displayed, PIP is loaded and ready to use.

```
*B:=A:COPY.COM[V<CR>
```

Copy COPY.COM onto B: from A:

```
*B:=A:HELP.COM[V<CR>
```

Copy HELP.COM onto B: from A:

When you are finished with the PIP '*', type ^C to clear PIP and return to CP/M. You can also clear PIP and return to CP/M by typing <CR>.

```
*^C
```

^C to clear PIP

```
A>
```

'A' prompt

```
A>XDIR B:<CR>
```

Run XDIR on B: from A:

CP/M SYS DISK

A:

B:

TEST DISK

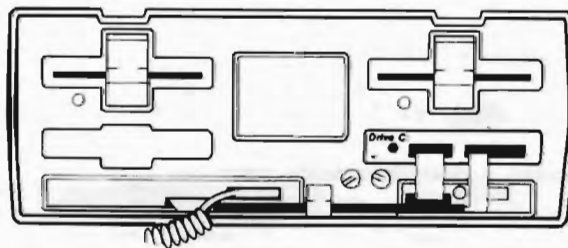

COPY	.COM
HELP	.COM
SETUP	.COM
STAT	.COM
SUBMIT	.COM
SYSGEN	.COM
XDIR	.COM

```
A>PIP B:=A:*. *[V<CR>
```

Copy ALL files onto B: from A:

The '*.*' includes ALL files and is the duplicate of the COPY command. This command copies ALL the files from A: onto B:.

CP/M Tutorial



```
A>XDIR B:<CR>
```

Run XDIR on B: from A:

CP/M SYS DISK

```
ASM      .COM
AUTOST   .COM
COPY     .COM
DDT      .COM
DUMP     .COM
ED       .COM
HELP     .COM
LOAD     .COM
MOVCPM   .COM
PIP      .COM
SETUP    .COM
STAT     .COM
SUBMIT   .COM
SYSGEN   .COM
XDIR     .COM
XSUB     .COM
```

A:

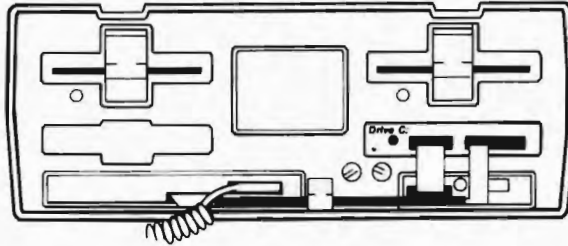

B:

TEST DISK

```
ASM      .COM
AUTOST   .COM
COPY     .COM
DDT      .COM
DUMP     .COM
ED       .COM
HELP     .COM
LOAD     .COM
MOVCPM   .COM
PIP      .COM
SETUP    .COM
STAT     .COM
SUBMIT   .COM
SYSGEN   .COM
XDIR     .COM
XSUB     .COM
```

PIP replaced the files on B: that had the same name. PIP does NOT replace files on the destination disk that have different names.

Therefore, you must have enough space available on the destination disk to accommodate the files you are copying. XDIR can always tell you how much space is left on the destination disk and how much space the files you are copying will require.



CP/M Tutorial

4-8 ERASING FILES

If there isn't enough room on the destination disk, you may want to make room by ERASING a file.

```
A>ERA B:HELP.COM<CR>
```

Erase HELP.COM on B:

The ERA (ERASE) command is a CP/M Utility like DIR. It is always available.

```
A>ERA B:S*.*<CR>
```

Erase files starting with 'S' on B:

The '*' (WILDCARD) can be used with ERA just as it's used with DIR.

CP/M SYS DISK

A:

B:

TEST DISK

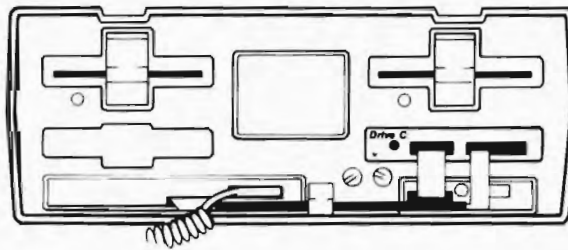

ASM	.COM
AUTOST	.COM
COPY	.COM
DDT	.COM
DUMP	.COM
ED	.COM
LOAD	.COM
MOVCPM	.COM
PIP	.COM
XDIR	.COM
XSUB	.COM

```
A>ERA B:*.*<CR>
```

Erase ALL files on B:

```
ALL(Y/N)? Y<CR>
```

CP/M checks to erase ALL

ERA makes sure that you REALLY want to erase ALL the files on a diskette by asking explicitly for a Yes or No answer.

```
A>XDIR B:<CR>
```

Run XDIR on B: from A:

The TEST DISK in B: is now blank.

CP/M SYS DISK

A:

B:

TEST DISK

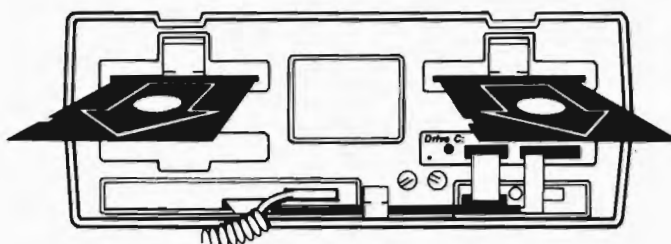

Formatted, blank
with CP/M



4-9 CP/M ERROR MESSAGES

CP/M will display error messages if the diskette you are trying to use cannot be accessed for some reason.

Some common error messages and the reasons for the errors are:

Unformatted diskette on drive _ **Bdos Err On _ : Select**

The diskette is not yet formatted.

The diskette is formatted double-density but your CP/M System is single-density.

The drive is not ready, i.e. the drive door is not closed completely, no disk in the drive.

NO SPACE

CP/M message when there is not enough space on a logical drive for the file you are trying to copy.

Bdos Err On _ : File R/O

CP/M message when trying to erase or to write over a Read-Only (R/O) file.

Bdos Err On _ : Bad Sector

CP/M message caused by a data error on either floppy disk or Drive C. Can be caused by 1) hardware failure of 01 disk controller or drive, 2) bad diskette, or 3) hardware data error on Drive C unit.

DISK WRITE ERROR: -FILENAME.FILEEXTENSION

PIP message when copying a file and there is not enough space on the disk.

To EXIT from the Error conditions listed above:

These errors will usually cause CP/M to "hang up", i.e. CP/M will not return to the A>. You must place a formatted disk in the drive and properly close the door of the drive specified by the Bdos Error message. Then press ^C to return to the A>.

Bdos Err On _ : Select

If this message is displayed by itself, a non-existent drive was specified. You may get this error if you try to access Drive C without running DCL first.

You will have to press the RESET button to EXIT from this error condition.

This completes the section on CP/M basics.



Learning Drive C Skills

CONTENTS

USING THE RAM-disk
USING THE PRINT BUFFER
USING THE Drive C UTILITY PROGRAM

This section of the manual teaches you how to use the individual features of the RAM-disk and Print Buffer, as well as DCU, the Drive C Utility program.

Your Drive C has many powerful yet easy-to-use features. The exercises in this section will familiarize you with how each one works.

Each feature can be run using a simple command. Once you find which features best fit your needs, you can use them automatically.

The Drive C RAM-disk is installed on your Osborne as a third logical drive with a single command, DCL. Variations of the DCL command will install Drive C with a new drive name and also install the Print Buffer. ALL of the Drive C features can be installed with a one-line DCL command statement.

Your Drive C and floppy drives can be renamed at any time using the DCN command.

Eight different sizes of Fixed Print Buffer and a variable Dynamic Print Buffer can be installed with your RAM-disk. Once installed, the Print Buffer feature works automatically.

The DCU Utility program can be used to increase the flexibility of your Print Buffer.

DCU E is a special feature which allows you to erase the contents of the Drive C RAM-disk without affecting the Print Buffer.

Using The RAM-disk



CONTENTS

- 5-1 GETTING READY
- 5-2 INSTALLING THE RAM-disk
- 5-3 COPYING FILES ONTO THE RAM-disk
- 5-4 SAVING FILES FROM THE RAM-disk TO FLOPPY
- 5-5 INSTALLING THE RAM-disk AS DRIVE A:
- 5-6 INSTALLING THE RAM-disk WITH DIFFERENT DRIVE NAMES
- 5-7 Drive C AND THE RESET BUTTON
- 5-8 RENAMING THE RAM-disk AFTER INSTALLATION
- 5-9 RUNNING WORDSTAR ON Drive C - DOING IT MANUALLY

5-1 GETTING READY

Before starting the step-by-step instructions for using your Drive C, you will need another blank, formatted diskette.

This diskette should be labeled "DC DEMO DISK" and will be used for your learning exercises.

Format the DC DEMO DISK double-density unless you have a single-density 01.

Turn ON power to your computer.

DC USER DISK

A:

B:

CP/M SYS DISK

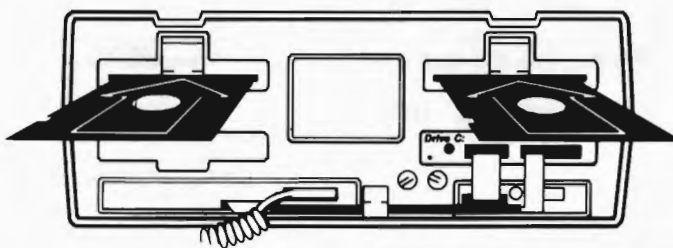

Drive C NOT INSTALLED

Press <CR> to load CP/M. The A> should appear on your screen.

A>

'A' prompt

A>PIP A:=B:SYSGEN.COM[V<CR>

Copy SYSGEN.COM onto A:,
the DC USER DISK, from B:

A>

'A' prompt



Using The RAM-disk

DC USER DISK

A:

B:

CP/M SYS DISK

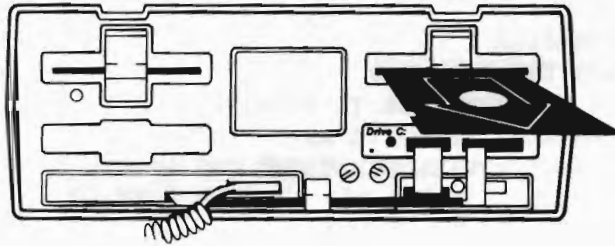

Drive C NOT INSTALLED

DC USER DISK

A:

B:

DC DEMO DISK

DCA .COM
 DCL .COM
 DCQ .COM
 DCQ .DAT
 DCQAUT .COM
 DCQINS .COM
 DCU .COM
 DFD .SPR
 PIP .COM
 PRN .TST
 SYSGEN .COM
 XDIR .COM

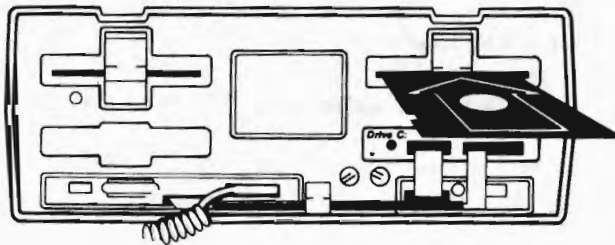

Drive C NOT INSTALLED

Formatted, blank
Single- or Double-
Density

A>^C

^C to clear CP/M

CP/M must be copied onto the DC DEMO DISK.

A>SYSGEN<CR>

Run SYSGEN from A:

SOURCE drive (A or B) A

Put SOURCE diskette in drive A, then press RETURN <CR>
System read successfully.

DESTINATION (A,B or RETURN to exit) B

Put DESTINATION diskette in B, then press RETURN <CR>
System copied successfully.

DESTINATION (A,B or RETURN to exit) <CR>

A>

'A' prompt, return to CP/M

Using The RAM-disk



```
A>PIP<CR>
*B:=A:DCL.COM[V<CR>
*B:=A:DFD.SPR[V<CR>
*^C
A>
```

Run PIP from A:
 Copy DCL.COM onto B: from A:
 Copy DFD.SPR onto B: from A:
 Press ^C to clear PIP
 The 'A' prompt

DC USER DISK

A:

B:

DC DEMO DISK

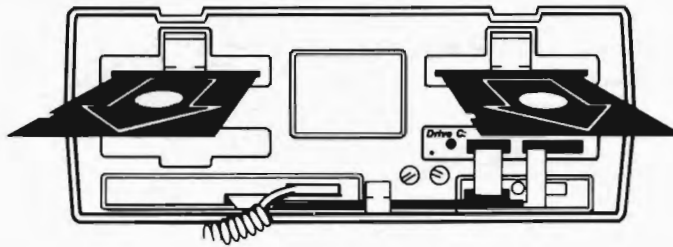

Drive C NOT INSTALLED

(CP/M on SYSTEM TRACKS)

DCL .COM
 DFD .SPR

DC DEMO DISK

A:

B:

DC USER DISK

(CP/M on SYSTEM TRACKS)

DCL .COM
 DFD .SPR

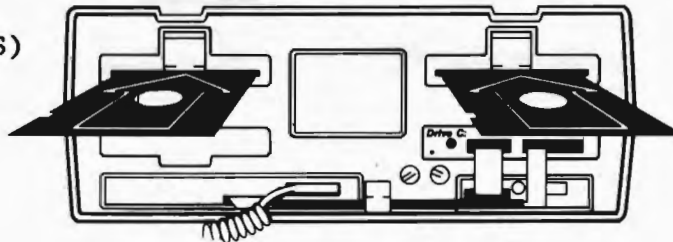

Drive C NOT INSTALLED

Press the [RESET] button.

Press <CR> to load CP/M. The A> should appear on your screen.

```
A>
```

The 'A' prompt

CP/M must always be loaded before loading the Drive C software. The 'A' prompt indicates that CP/M has been successfully loaded onto your Osborne 1.



Using The RAM-disk

5-2 INSTALLING THE RAM-disk

The Drive C LOADER software (DCL.COM) must be loaded (installed) into your Osborne before you can use Drive C.

```
A>DCL<CR>
```

Install the Drive C RAM-disk as C:

```
A>
```

The 'A' prompt

Drive C is now installed as the third logical drive on your Osborne, drive C:. It can be used exactly like your floppy disk drives, drive A: and drive B:.

Two files were necessary to install Drive C, DCL.COM and DFD.SPR. DCL.COM can be on either floppy disk drive, but it's simplest to keep it on A:. THE FILE DFD.SPR MUST BE ON LOGICAL DRIVE A: DURING THE INITIAL INSTALLATION OF THE Drive C RAM-disk.

```
A>B:XDIR C:<CR>
```

Run XDIR on C: from B:

DC DEMO DISK

DCL .COM
DFD .SPR

A:

B:

DC USER DISK

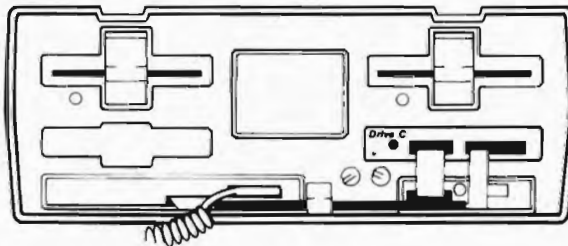

C:

DCN .COM
Drive C: .SYS

The files DCN.COM and Drive C:.SYS on the Drive C unit were created automatically when the Drive C unit was installed.

Drive C, unlike a floppy disk, does not need to be formatted to be used. Nor does CP/M need to be placed on Drive C with SYSGEN. Once installed, Drive C looks exactly like a formatted diskette ready to accept files.

```
A>C:<CR>
```

Log onto C:, the Drive C unit

```
C>DIR<CR>
```

Run DIR from C:

The CP/M utilities, like DIR, are available on the Drive C RAM-disk. The file Drive C:.SYS is a SYSTEM file and will not be displayed by DIR. To check for the Drive C:.SYS file, use XDIR or STAT.

Using The RAM-disk



5-3 COPYING FILES ONTO THE RAM-disk

To use the Drive C RAM-disk, files must be copied onto it from the floppy disks.

The simplest way to copy files onto the Drive C RAM-disk is with a copy program like PIP. Other programs like SWEEP or WASH can also be used.

```
C>B:PIP<CR>
```

Run PIP from B:

```
*C:=B:DCU.COM[V<CR>
```

Copy DCU.COM onto C: from B:

```
*C:=B:PIP.COM[V<CR>
```

Copy PIP.COM onto C: from B:

```
*C:=B:XDIR.COM[V<CR>
```

Copy XDIR.COM onto C: from B:

```
*^C
```

^C to clear PIP

```
C>XDIR<CR>
```

Run XDIR from C:

DC DEMO DISK

```
DCL .COM
DFD .SPR
```

A:

B:

DC USER DISK

```
DCA .COM
DCL .COM
DCQ .COM
DCQ .DAT
DCQAUT .COM
DCQINS .COM
DCU .COM
DFD .SPR
PIP .COM
PRN .TST
SYSGEN .COM
XDIR .COM
```

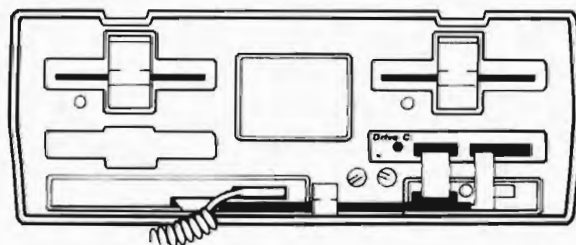

C:

```
DCN .COM
DCU .COM
Drive C: .SYS
PIP .COM
XDIR .COM
```

The files DCU.COM, PIP.COM and XDIR.COM were copied onto drive C:, the Drive C RAM-disk, by using the PIP command from drive B:.

Once you have copied files onto the Drive C RAM-disk, you can use these files just as you would on your floppy disks.

By logging onto drive C: (C>), programs on drive C:, like XDIR, can be used.



Using The RAM-disk

5-4 SAVING FILES FROM THE RAM-disk TO FLOPPY

When your Osborne is turned OFF, the contents of the Drive C RAM-disk will not be retained.

Files on Drive C which you want to save (backup) will need to be stored onto floppy disks.

Again, the simplest way to copy files from the Drive C RAM-disk onto your floppy disks is with a copy program like PIP or SWEEP.

```
C>PIP<CR>
```

Run PIP from C:

```
*A:=C:DCU.COM,V<CR>
```

Copy DCU.COM onto A: from C:

```
*A:=C:PIP.COM[V<CR>
```

Copy PIP.COM onto A: from C:

```
*A:=C:XDIR.COM[V<CR>
```

Copy XDIR.COM onto A: from C:

```
*^C
```

^C to clear PIP

```
C>XDIR A:<CR>
```

Run XDIR on A: from C:

DC DEMO DISK

```
DCL      .COM
DCU      .COM
DFD      .SPR
PIP      .COM
XDIR     .COM
```

A:

B:

DC USER DISK

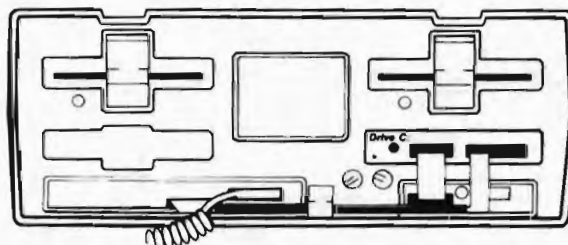

C:

```
DCN      .COM
DCU      .COM
Drive C: .SYS
PIP      .COM
XDIR     .COM
```

The files DCU.COM, PIP.COM and XDIR.COM were first copied onto the Drive C RAM-disk, drive C:, from the floppy disk, drive B:, using the PIP command from drive B:.

The same files were then saved onto the floppy disk, drive A:, by using the PIP command from drive C:.

Using The RAM-disk

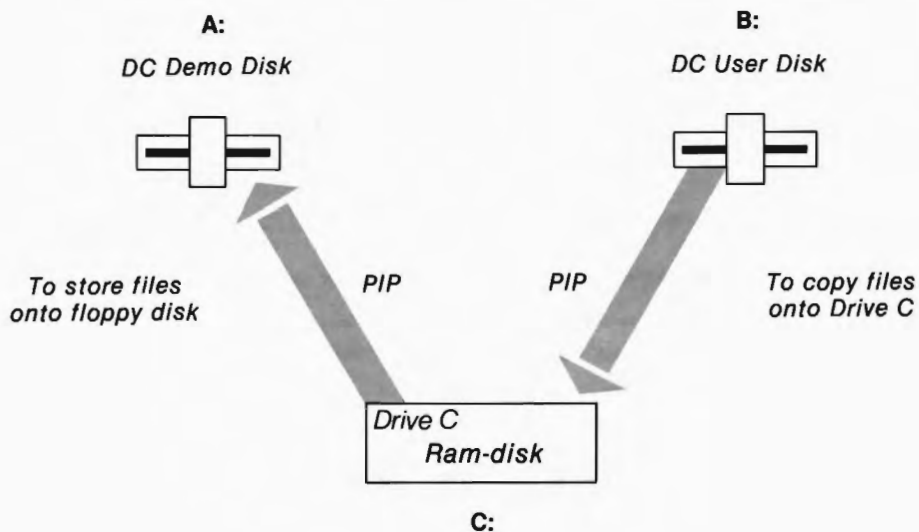



Using The RAM-disk

5-5 INSTALLING THE RAM-disk AS DRIVE A:

The Drive C unit is installed as logical drive A: by adding the drive letter A to the DCL command. To re-install Drive C, first RESET your Osborne. Drive C is no longer installed after pressing the RESET button but the files remain.

Press the [RESET] button.

DC DEMO DISK

A:

B:

DC USER DISK

DCL	.COM
DCU	.COM
DFD	.SPR
PIP	.COM
XDIR	.COM

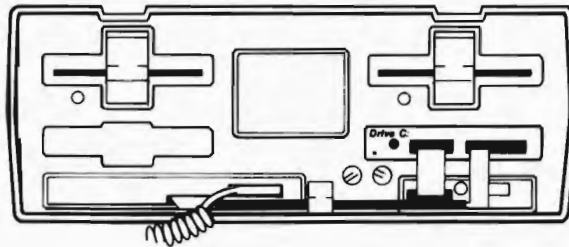

Drive C NOT INSTALLED

Press <CR> to load CP/M. The A> should appear on your screen.

A>DCL A<CR>

Install Drive C as A:

C>XDIR A:<CR>

Run XDIR on A:, the Drive C unit from left floppy, C:

DC DEMO DISK

C:

B:

DC USER DISK

DCL	.COM
DCU	.COM
DFD	.SPR
PIP	.COM
XDIR	.COM

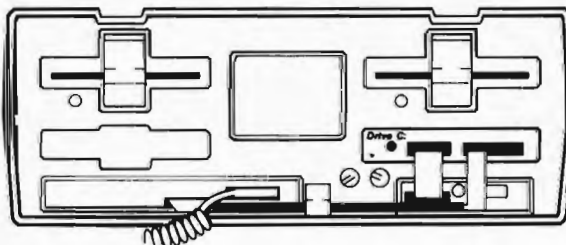

A:

DCN	.COM
DCU	.COM
Drive C:	.SYS
PIP	.COM
XDIR	.COM

Using The RAM-disk



5-6 INSTALLING THE RAM-disk WITH DIFFERENT DRIVE NAMES

The command DCL A is an example of a general rule:

THE LETTER AFTER THE DCL COMMAND WILL BE THE LOGICAL DRIVE NAME OF THE DRIVE C UNIT. THERE MUST BE A SPACE BETWEEN DCL AND THE DRIVE LETTER.

DCL A will install the Drive C unit as drive A:.

DCL B will install the Drive C unit as drive B:.

DCL or DCL C will install the Drive C unit as drive C:.

After installing the Drive C unit as A:, the left-hand floppy is renamed C: and the C> appears on the screen.

Another general rule is:

IF THE DRIVE C UNIT IS INSTALLED AS A: OR B:, THE FLOPPY DISK DRIVE THAT WAS ORIGINALLY A: OR B: WILL BE RENAMED C:.

If the Drive C unit is named A:, the original A: drive will be renamed C:.

If the Drive C unit is named B:, the original B: drive will be renamed C:.



Using The RAM-disk

5-7 Drive C AND THE RESET BUTTON

The RESET button was pressed when Drive C was re-installed as A: in the previous exercise. The files on the Drive C unit are still present after a RESET.

```
C>A:<CR>
```

Log onto the Drive C unit, A:

```
A>XDIR<CR>
```

Run XDIR from A:

DC DEMO DISK

```
DCL .COM
DCU .COM
DFD .SPR
PIP .COM
XDIR .COM
```

C:

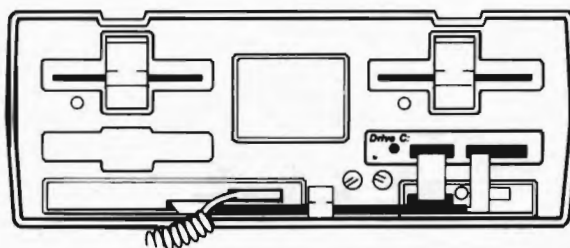

B:

DC USER DISK

A:

```
DCN .COM
DCU .COM
Drive C:.SYS
PIP .COM
XDIR .COM
```

Drive C:.SYS, a zero K (OK), R/O (READ ONLY) file keeps the files on the Drive C: unit when the RESET button is pressed.

In order to access the files on the Drive C: unit after pressing the RESET button, you only need to reload Drive C using the DCL command.

Re-installing the Drive C unit with a new drive name does not affect files already on Drive C.

Using The RAM-disk

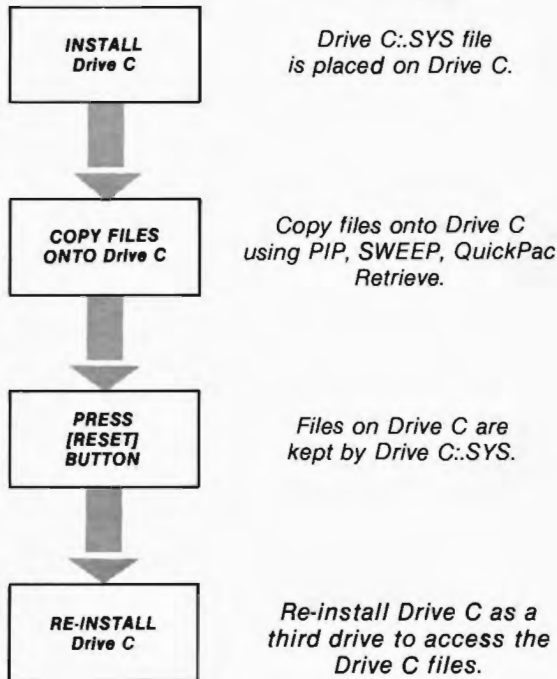



Using The RAM-disk

5-8 RENAMING THE RAM-disk AFTER INSTALLATION

The Drive C RAM-disk and the floppy disk drives can be renamed at any time using the DC NAME (DCN.COM) program.

DCN.COM, like the Drive C: .SYS file, is created and placed on the actual Drive C unit regardless of its logical drive name.

DC DEMO DISK

C:

B:

DC USER DISK

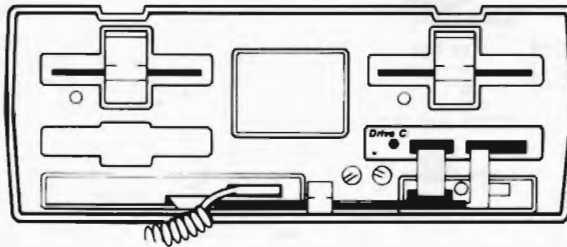

A:

```
A>DCN C<CR>
```

Rename the Drive C unit,
drive A:, to C:

```
C>
```

The 'C' prompt

The Drive C unit, drive A:, is now renamed drive C:.

Since you did not move to a different drive, DCN returned you to the drive you were logged onto, the Drive C unit, with the NEW name, drive C:.

The C> prompt therefore appeared after changing the drive names.

Using The RAM-disk



```
C>XDIR<CR>
```

Run XDIR from C:,
the Drive C unit

DC DEMO DISK

```
DCL      .COM
DCU      .COM
DFD      .SPR
PIP      .COM
XDIR     .COM
```

A:

B:

DC USER DISK

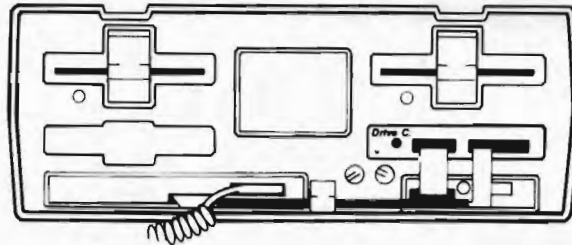

C:

```
DCN      .COM
DCU      .COM
Drive C: .SYS
PIP      .COM
XDIR     .COM
```

This is an example of a general rule:

THE LETTER AFTER THE DCN COMMAND WILL BE THE LOGICAL DRIVE NAME OF THE DRIVE C UNIT.

DCN A will rename the Drive C unit as drive A:.

DCN B will rename the Drive C unit as drive B:.

DCN C will rename the Drive C unit as drive C:.



Using The RAM-disk

5-9 RUNNING WORDSTAR ON Drive C - DOING IT MANUALLY

You now have all the tools necessary to run WordStar on the Drive C unit renamed drive A:.

This exercise will copy and run WordStar MANUALLY.

DC DEMO DISK

A:

B:

DC USER DISK

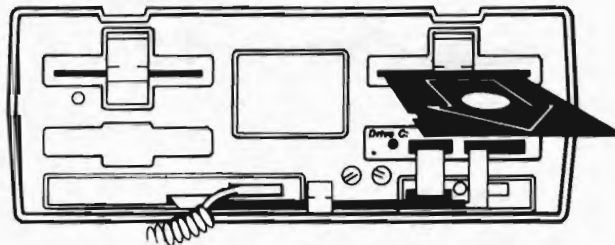

C:

DC DEMO DISK

A:

B:

WordStar DISK

DCL	.COM
DCU	.COM
DFD	.SPR
PIP	.COM
XDIR	.COM

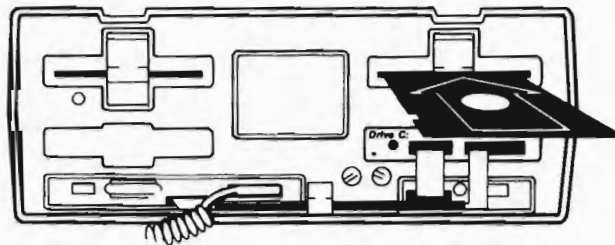

C:

AUTOST	.COM
INSTALL	.COM
MERGPRIN	.OVR
SAMPLE	.TXT
WS	.COM
WSMSG	.OVR
WSOVLY1	.OVR
XDIR	.COM

DCN	.COM
DCU	.COM
Drive C:	.SYS
PIP	.COM
XDIR	.COM

C>^C

^C to clear CP/M

C>DCN A<CR>

Rename the Drive C unit to A:

A>PIP A:=B:WS*.*[V<CR>

Copy the WordStar files onto A:, the Drive C unit, from B:

Using The RAM-disk



The three WordStar files are copied from the floppy diskette in drive B: onto drive A:, the Drive C unit, using PIP.

A>XDIR<CR>

Run XDIR from A:

DC DEMO DISK

DCL .COM
DCU .COM
DFD .SPR
PIP .COM
XDIR .COM

C:

B:

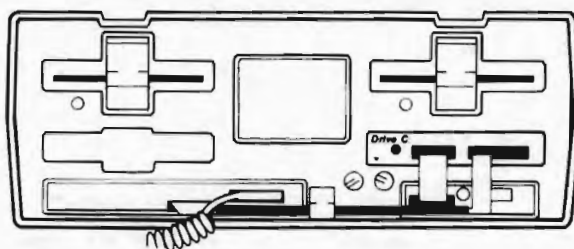

WordStar DISK

AUTOST .COM
INSTALL .COM
MERGPRIN.OVR
SAMPLE .TXT
WS .COM
WSMSGs .OVR
WSOVLY1 .OVR
XDIR .COM

A:

DCN .COM	WS .COM
DCU .COM	WSMSGs .OVR
Drive C: .SYS	WSOVLY1 .COM
PIP .COM	XDIR .COM

A>WS<CR>

Run WordStar from A:

WordStar is now loaded and ready to use on drive A:, the Drive C unit.

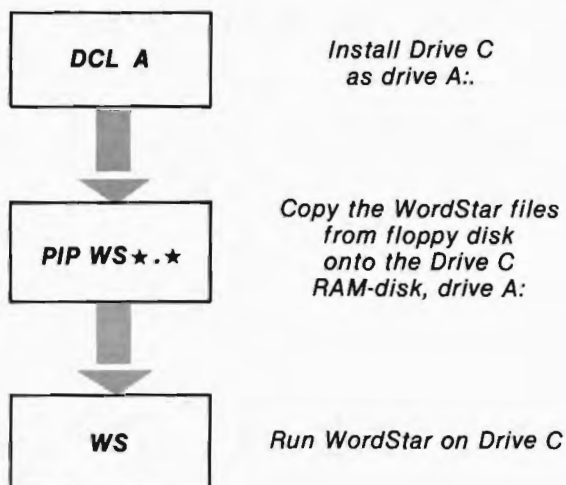



Using The RAM-disk

Press 'X' to EXIT WordStar.

```
A>
A>DCU E<CR>
```

The 'A' prompt
Run DCU E (Erase) from A:

```
Erase all (including R/O) Drive C: files (Y/N)? Y
Are you sure (Y/N)? Y
```

```
A>C:XDIR<CR>
```

Run XDIR on A: from C:

The files on Drive C (with the exception of Drive C:.SYS) have been erased for the next exercise.

DC DEMO DISK

C:

B:

WordStar DISK

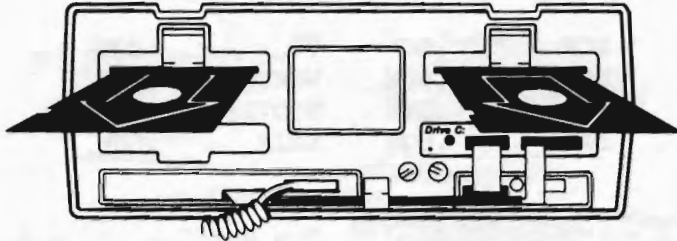

A:

Press the [RESET] button.

This completes the section on installing the Drive C RAM-disk.

Using The Print Buffer



CONTENTS

- 5-10 PRINT BUFFER OPERATION
- 5-11 INSTALLING THE PRINT BUFFER
- 5-12 THE FIXED PRINT BUFFER
- 5-13 THE DYNAMIC PRINT BUFFER
- 5-14 USING THE DYNAMIC PRINT BUFFER

5-10 PRINT BUFFER OPERATION

The Print Buffer feature of your Drive C lets you compute and print at the same time.

When you print a file, you can not run a program because your printer has control of your Osborne until the printing operation is completed. Printers are slow and your OI can be tied up for considerable lengths of time.

The Print Buffer LOOKS like your printer to your Osborne. The print output is sent to the Print Buffer just as it would be sent to your printer. But the Print Buffer temporarily stores the print output at high speed while simultaneously sending it to the printer at the printer's slow speed.

Your Osborne THINKS it has finished printing a file when all of the print output has been transferred to the Print Buffer. The CP/M prompt or your program is available while the Print Buffer continues to print the file.

After the contents of the Print Buffer has been printed, the Print Buffer is automatically cleared and the space is again available for more print output from your Osborne.

When the Print Buffer is installed, your Drive C is partitioned into two parts, the RAM-disk and the Print Buffer.

The Fixed Print Buffer is a space solely dedicated to print buffer operation. Eight different Fixed Buffer sizes are available:

16K, 32K, 48K, 64K, 80K, 96K, 112K, 128K

The RAM-disk will be decreased in size by the amount of space you choose to allocate to the Fixed Buffer.

The Dynamic Print Buffer, P, does NOT allocate a specific amount of space for print buffer operation. Instead, any space not used by the RAM-disk for files can be used for the Print Buffer.

The Print Buffer is installed at the same time that you install the RAM-disk.

Once installed, print buffer operation is transparent. This means you can send your print output to your printer using your regular commands and the Print Buffer will be automatically engaged. No special commands are necessary.



Using The Print Buffer

If the amount of information to be printed is larger than the space available in the Print Buffer, the computer will print the excess amount at the same speed as if there were no Print Buffer present, i.e. that is, it will only be able to transfer additional data to the buffer as quickly as the printer empties the buffer.

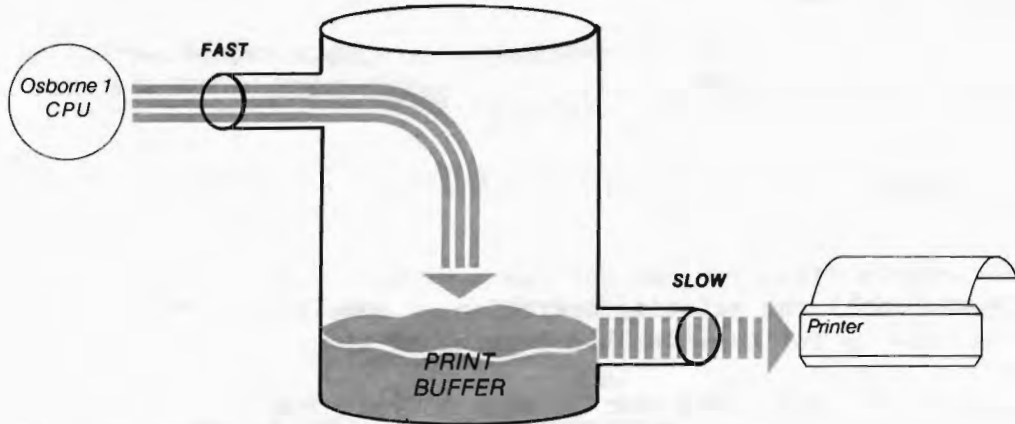

When the Print Buffer isn't full, it accepts data much faster than the printer can print it.

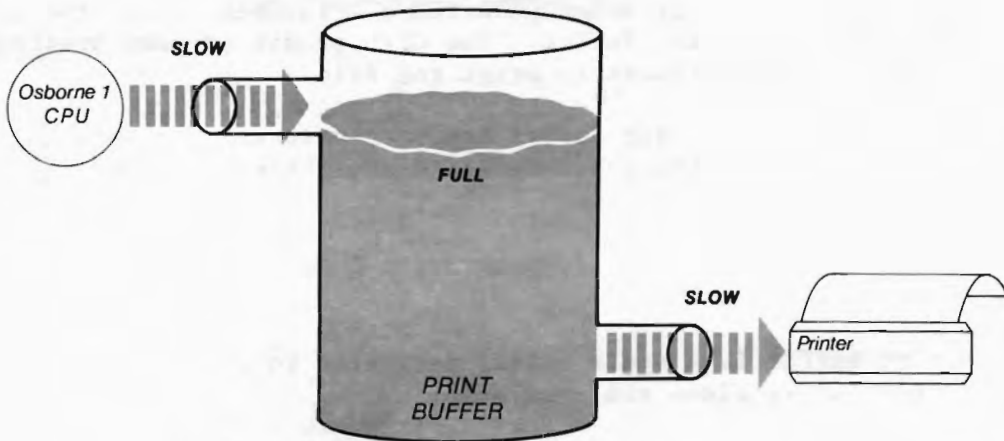

When the Print Buffer is full, it accepts data at the SAME speed that it prints it.

Using The Print Buffer



5-11 INSTALLING THE PRINT BUFFER

The Print Buffer must be installed at the same time that the Drive C RAM-disk is installed by using the DCL command.

The general rules are:

TO INSTALL THE FIXED PRINT BUFFER, THE PRINT BUFFER SIZE FOLLOWS THE DCL COMMAND WHEN LOADING Drive C.

TO INSTALL THE DYNAMIC PRINT BUFFER, THE LETTER P FOLLOWS THE DCL COMMAND WHEN LOADING Drive C.

IF YOU USE THE RENAME OPTION WITH THE DCL COMMAND, THE PRINT BUFFER OPTION FOLLOWS THE NEW DRIVE LETTER.

THERE MUST BE A SPACE BETWEEN THE DCL COMMAND AND THE PRINT BUFFER OPTION.

BUFFER SIZE	BUFFER TYPE	RAM-disk NAME		
		A:	B:	C:
16K	FIXED	DCL A 16	DCL B 16	DCL 16
32K	FIXED	DCL A 32	DCL B 32	DCL 32
48K	FIXED	DCL A 48	DCL B 48	DCL 48
64K	FIXED	DCL A 64	DCL B 64	DCL 64
80K	FIXED	DCL A 80	DCL B 80	DCL 80
96K	FIXED	DCL A 96	DCL B 96	DCL 96
112K	FIXED	DCL A 112	DCL B 112	DCL 112
128K	FIXED	DCL A 128	DCL B 128	DCL 128
VARIABLE	DYNAMIC	DCL A P	DCL B P	DCL P

The Print Buffer is automatically removed when the RESET button is pressed. To eliminate the Print Buffer or to change the Print Buffer, press the RESET button and re-install Drive C with a new Print Buffer option.



Using The Print Buffer

5-12 THE FIXED PRINT BUFFER

The Fixed Print Buffer is installed as part of the DCL command.

DC DEMO DISK

DCL	.COM
DCU	.COM
DFD	.SPR
PIP	.COM
XDIR	.COM

A:

B:

DC USER DISK

DCA	.COM
DCL	.COM
DCQ	.COM
DCQ	.DAT
DCQAUT	.COM
DCQINS	.COM
DCU	.COM
DFD	.SPR
PIP	.COM
PRN	.TST
SYSGEN	.COM
XDIR	.COM

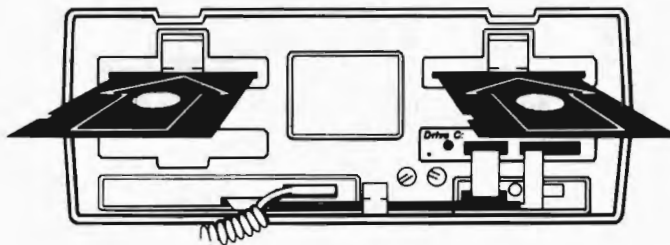

Drive C NOT INSTALLED

Press <CR> to load CP/M. The A> should appear on your screen.

A>DCL A<CR>

Install Drive C as A:
WITHOUT the Fixed Print Buffer

C>XDIR A:<CR>

Run XDIR on A:, the Drive C unit,
from C:

The SIZE of the Drive C RAM-disk is the SIZE displayed by XDIR. Since the Fixed Print Buffer is not yet installed, the SIZE will be either 192K or 384K, the total capacity of the Drive C unit. Next, your Drive C will be re-installed with the 16K Fixed Print Buffer.

Press the [RESET] button.

Press <CR> to load CP/M. The A> should appear on your screen.

A>DCL A 16<CR>

Install Drive C as A: with 16K
Fixed Print Buffer

C>XDIR A:<CR>

Run XDIR on A: from C:

The 16K Fixed Print Buffer is now installed. This time, XDIR shows the SIZE of the Drive C RAM-disk to be reduced by 16K (176K or 368K).

Using The Print Buffer



DC DEMO DISK

DCL .COM
DCU .COM
DFD .SPR
PIP .COM
XDIR .COM

C:

B:

DC USER DISK

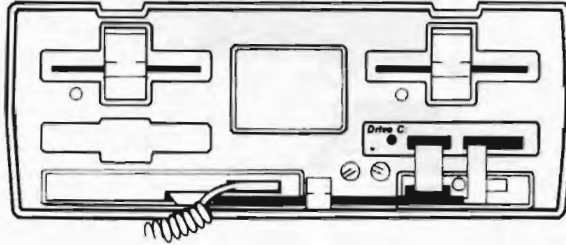

A:

DCN .COM
DCU .COM
Drive C: .SYS

The DC Utilities program (DCU.COM) is automatically copied onto the Drive C unit from drive A: when the Print Buffer is installed.

DCU.COM contains several powerful utilities to use with your Print Buffer. If DCU.COM is not present on drive A: when you load the Print Buffer, the following helpful message will appear on the screen:

Note: print buffer utility (DCU.COM) not available



Using The Print Buffer

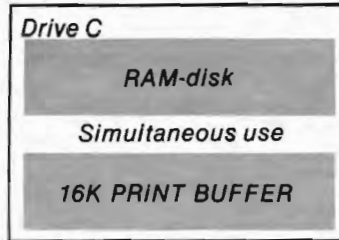

If you type an incorrect size for the Fixed Buffer, DCL 28 for instance, the Drive C RAM-disk will be installed but no Print Buffer will be installed. The following message will appear on the screen:

Bad print buffer parameter, not loaded

If you have files on the RAM-disk and re-install a Fixed Buffer which is larger than the available space on Drive C, the Dynamic Buffer will automatically be installed instead. The following message will appear on the screen:

Not enough space for fixed print buffer

Using The Print Buffer



5-13 THE DYNAMIC PRINT BUFFER

The Dynamic Print Buffer is installed with the DCL command using the 'P' option.

Press the [RESET] button

Press <CR> to load CP/M. The A> should appear on your screen.

```
A>DCL A P<CR>
```

Install Drive C as A: with the Dynamic Print Buffer P

```
C>PIP A:=C:XDIR.COM[V<CR>
```

Copy XDIR.COM onto A: from C:

```
C>PIP A:=C:PIP.COM[V<CR>
```

Copy PIP.COM onto A: from C:

```
C>PIP A:=B:DCA.COM[V
```

Copy DCA.COM onto A: from B:

```
C>A:<CR>
```

Log onto A:, the Drive C unit

```
A>XDIR<CR>
```

Run XDIR from A:

The Dynamic Print Buffer, the 'P' option, is now installed. The Extended Directory of drive A:, the Drive C unit, does NOT show the size of the RAM-disk to be decreased (192K or 384K).

The Dynamic Print Buffer constantly changes size as more or less file space is used in the RAM-disk. The Extended Directory will automatically show the RAM-disk reduced in size ONLY when the Dynamic Buffer actually contains output for the printer.

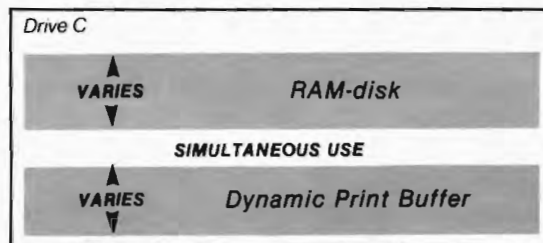



Using The Print Buffer

5-14 USING THE DYNAMIC PRINT BUFFER

This exercise is a demonstration of the Dynamic Print Buffer.

A>PIP A:=B:PRN.TST[V<CR> Copy PRN.TST from B: to A:

Make sure your printer is ON, has paper and is ready to print.

A>PIP LST:=PRN.TST<CR> Print PRN.TST using PIP

Your printer should now be printing the Drive C Print Test. When the entire PRN.TST file is in the Dynamic Print Buffer, the A> will reappear on your screen. You can now continue using your Osborne just as if you weren't printing at all.

TYPE THE FOLLOWING COMMAND WHILE YOUR PRINTER IS PRINTING:

A>XDIR<CR> Run XDIR from A: while
PRN.TST is being printed

The Extended Directory shows that the size of the RAM-disk has been decreased by the size of the PRN.TST file which is being printed by the Dynamic Buffer (if you have an internal buffer in your printer, the PRN.TST file may have been transferred from the Dynamic Buffer to your printer's buffer so quickly that the space was already returned to the RAM-disk).

The Dynamic Buffer space will be available for use again as RAM-disk only when the Dynamic Buffer has finished printing the PRN.TST file.

Please wait for your printer to stop printing before continuing with the next step.

A>XDIR<CR> Run XDIR from A: after
PRN.TST has been printed

The Dynamic Buffer is now empty and the Extended Directory will show that ALL of the Drive C unit is again available as RAM-disk.

Again, as with the Fixed Print Buffer, the DC Utilities program (DCU.COM) is automatically copied onto the Drive C unit from drive A: when the Print Buffer is installed.

DCU.COM contains several powerful utilities to use with your Print Buffer. If DCU.COM is not present on drive A: when you load the Print Buffer, the following helpful message will appear on the screen:

Note: print buffer utility (DCU.COM) not available

Using The Print Buffer

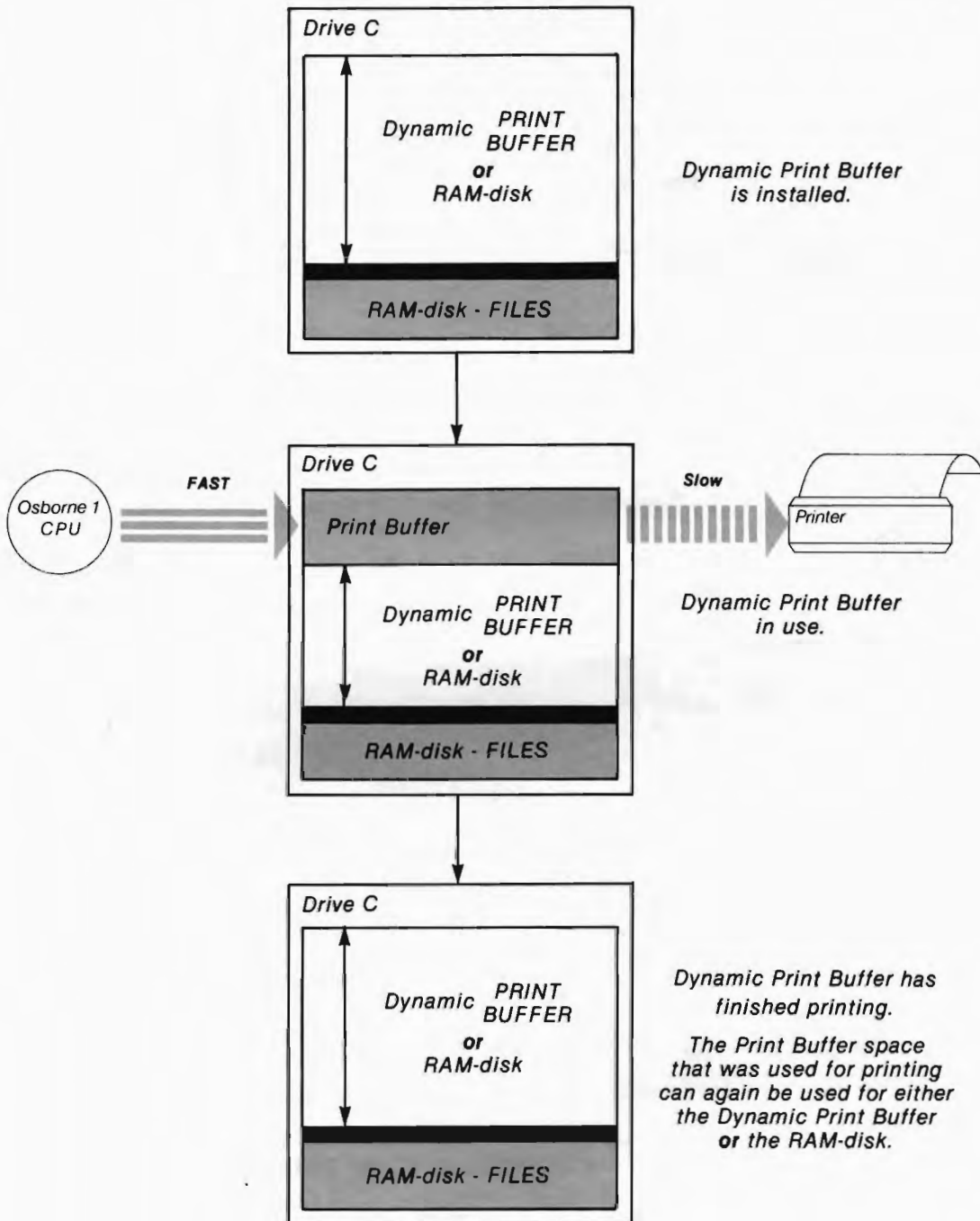



Using The Drive C Utility Program

CONTENTS

- 5-15 DCU - THE Drive C UTILITY PROGRAM
- 5-16 USING DCU S - THE SPACE OPTION
- 5-17 USING DCU O - THE OPTIMIZE OPTION
- 5-18 USING DCU TO CONTROL THE Drive C PRINT BUFFER
- 5-19 USING DCU WITHOUT THE MENU
- 5-20 DCU E - ERASING THE RAM-disk

5-15 DCU - THE Drive C UTILITY PROGRAM

DCU.COM, the Drive C Utility program, provides a number of powerful features to use with your Print Buffer.

```
A>DCU<CR>
```

Run DCU from A:

Typing the command DCU will display the DCU menu on the screen.

```
Buffer: type -  
        status -
```

- S - SPACE available for dynamic buffer
- O - OPTIMIZE space for dynamic buffer
- W - WAIT - pause print buffer operation
- R - RESTART - continue print buffer operation
- Z - ZAP - clear the print buffer
- X - EXIT to CP/M

Please enter one of the above options:

The type and current status of the Print Buffer will always be displayed at the top of the screen.

```
Buffer: type - dynamic  
        status - normal
```

The TYPE indicates whether the Print Buffer is Fixed or Dynamic. If the Print Buffer is Fixed, TYPE will show the size of the Fixed Print Buffer.

If you do not install the Print Buffer, the TYPE line will be blank.

TYPE Messages

- K fixed buffer - Size of Fixed Print Buffer
- dynamic - Dynamic Print Buffer P
- (BLANK) - Print Buffer NOT installed

Using The Drive C Utility Program



The STATUS indicates the current condition of the Print Buffer.

STATUS Messages

- normal** - installed
- NOT INSTALLED** - Print Buffer NOT installed
- **WAITING**** - Print Buffer has been interrupted



Using The Drive C Utility Program

5-16 USING DCU S - THE SPACE OPTION

The SPACE option 'S' shows how much space is available for use as the Dynamic Print Buffer.

```
Please enter one of the above options: S
```

```
There is ___K of SPACE available for dynamic buffer.
```

Please note the amount of SPACE available before returning to CP/M.

```
Please enter one of the above options: X
```

The 'X' option returns you to CP/M.

```
A>
```

The 'A' prompt

```
A>XDIR<CR>
```

Run XDIR from A:

The Extended Directory shows that more space is left on the Drive C unit than the DCU SPACE option indicated.

There is a good reason for the difference between the amount of space left on Drive C as shown by XDIR and how much space is left for the Dynamic Print Buffer as shown by the DCU SPACE option.

The boundary between the Dynamic Print Buffer and the RAM-disk is defined by the 'last' file in the RAM-disk. CP/M, however, does not keep the files in the RAM-disk tightly 'stacked' together.

Gaps may exist in the 'stack' of files in the RAM-disk. These extra spaces cannot be used by the Dynamic Print Buffer but are included in the space available shown by XDIR.

The DCU SPACE command will accurately tell you how much space is available for the Dynamic Print Buffer.

```
A>ERA XDIR.COM
```

Erase XDIR.COM from A:, the Drive C unit

Using The Drive C Utility Program

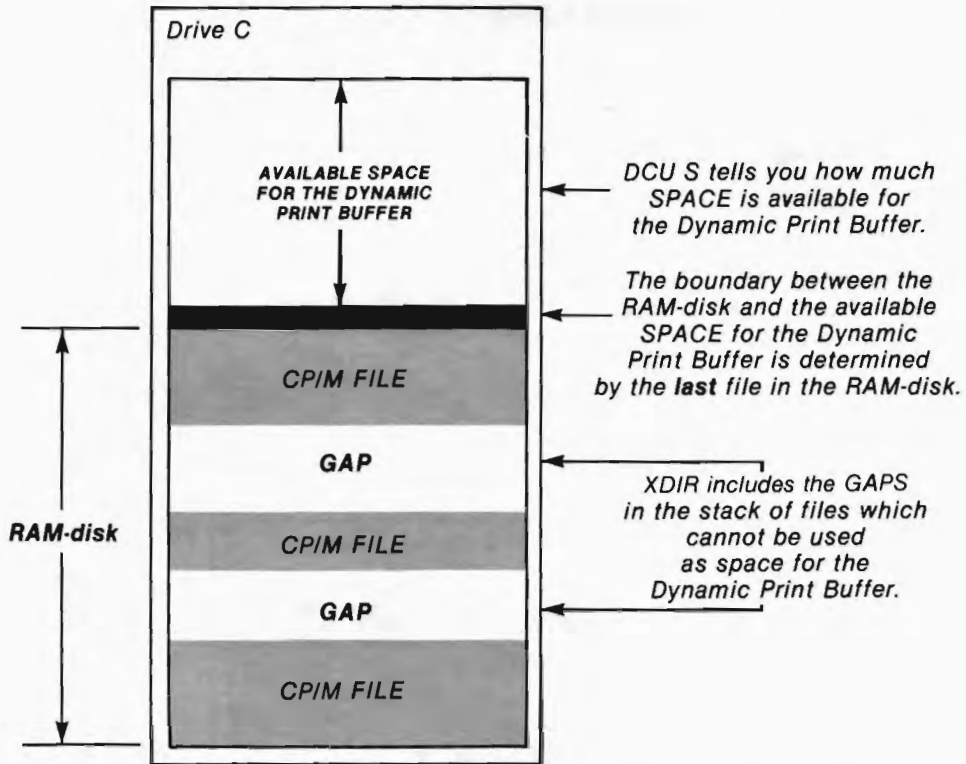

The DCU SPACE option will tell you how much space the Dynamic Print Buffer has (IF IT IS INSTALLED) or would have (IF YOU RESET AND INSTALLED IT).

PLEASE NOTE THAT THE DCU SPACE OPTION WORKS EVEN IF THE FIXED BUFFER IS INSTALLED OR IF NO PRINT BUFFER IS INSTALLED.



Using The Drive C Utility Program

5-17 USING DCU 0 - THE OPTIMIZE OPTION

The DCU 0 (OPTIMIZE) option packs (compresses) the RAM-disk files to eliminate the excess spaces between files. This optimizes (maximizes) the space in the Dynamic Print Buffer.

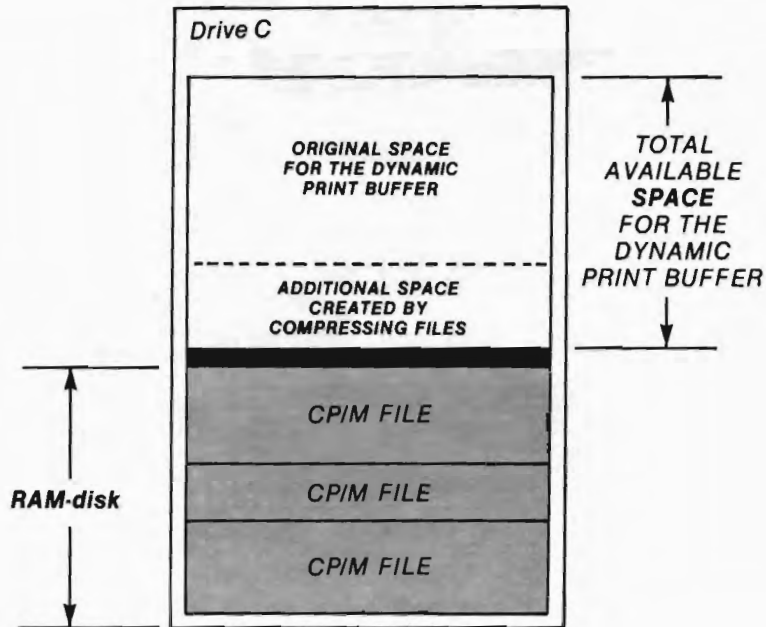

```
A>DCU<CR>
```

Run DCU from A:

```
Please enter one of the above options: S
```

```
There is ___K of SPACE available for dynamic buffer.
```

```
Please enter one of the above options: 0
```

```
Packing Drive C:...
```

```
The Drive C: packing has been completed.
```

```
There is ___K SPACE available for dynamic buffer.
```

The DCU 0 command added available SPACE for the Dynamic Print Buffer. Optimizing the size of the Dynamic Print Buffer may still not provide enough room for the files you wish to print.

If you need additional space, you can delete files from the RAM-disk.

```
Do you want to delete a file to add SPACE (Y/N)? Y
```

A directory of the files on the RAM-disk will appear on the screen showing the size of each file.

Using The Drive C Utility Program



FILE TO DELETE: DCA.COM<CR>

Files must be deleted individually and must be named exactly. The CP/M '*' (WILDCARD) convention cannot be used.

After a file is deleted, DCU 0 will automatically re-pack the RAM-disk to optimize the Dynamic Print Buffer SPACE. The new SPACE amount will be automatically displayed.

Do you want to delete a file to add SPACE (Y/N)? N

Type 'X' to return to CP/M:

Please enter one of the above options: X

A>

The 'A' prompt



Using The Drive C Utility Program

5-18 USING DCU TO CONTROL THE Drive C PRINT BUFFER

The DCU options R, W and Z are used to control the Print Buffer.

Please make sure your printer is ON, has paper and is ready to print for the following exercises.

A>PIP LST:=-PRN.TST<CR>

Print PRN.TST using PIP

Your printer should now be printing the Drive C Print Test. When the entire PRN.TST file is in the Dynamic Print Buffer, the A> will reappear on your screen, returning control of your Osborne back to you.

PLEASE DO THE FOLLOWING WHILE YOUR PRINTER IS PRINTING PRN.TST:

A>DCU<CR>

Run DCU from A:

Please enter one of the above options: **W**

DCU W (WAIT) interrupts the output to the printer.

DCU W will interrupt the output from the Drive C Print Buffer to the printer but cannot affect the internal operation of your printer's buffer.

PLEASE NOTE: IF YOUR PRINTER HAS AN INTERNAL PRINT BUFFER, IT WILL CONTINUE TO PRINT THE CONTENTS OF ITS OWN BUFFER UNTIL ITS EMPTY.

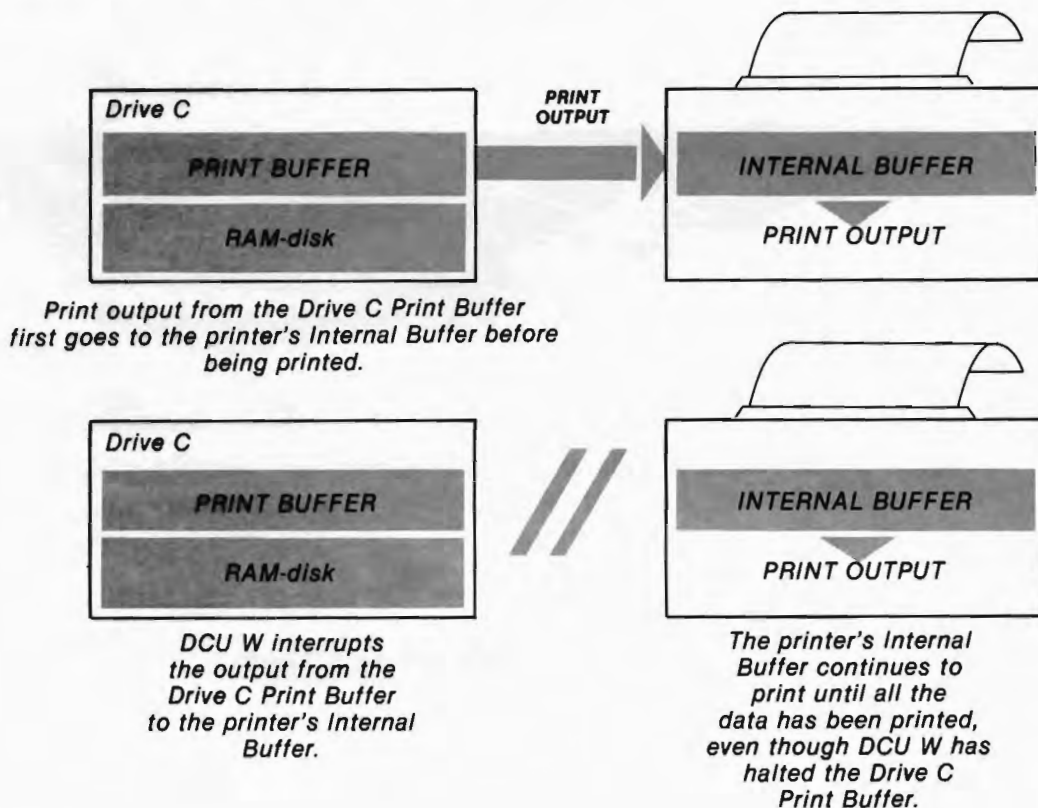

Using The Drive C Utility Program



Please enter one of the above options: **R**

DCU R (RESTART) will cause the Drive C Print Buffer to resume printing after being interrupted by DCU W.

Your printer should again be printing PRN.TST.

Please enter one of the above options: **Z**

DCU Z (ZAP) immediately clears the contents of either the Fixed Print Buffer or the Dynamic Print Buffer.

AGAIN, PLEASE NOTE THAT DATA IN YOUR PRINTER'S OWN PRINT BUFFER WILL CONTINUE TO BE PRINTED EVEN IF THE Drive C PRINT BUFFER HAS BEEN CLEARED BY DCU Z.

Once your print file is in the Drive C Print Buffer, it cannot be accessed by its name nor can multiple files in the print buffer be separated and manipulated individually. If several files are in the Print Buffer, they will ALL be cleared by DCU Z.

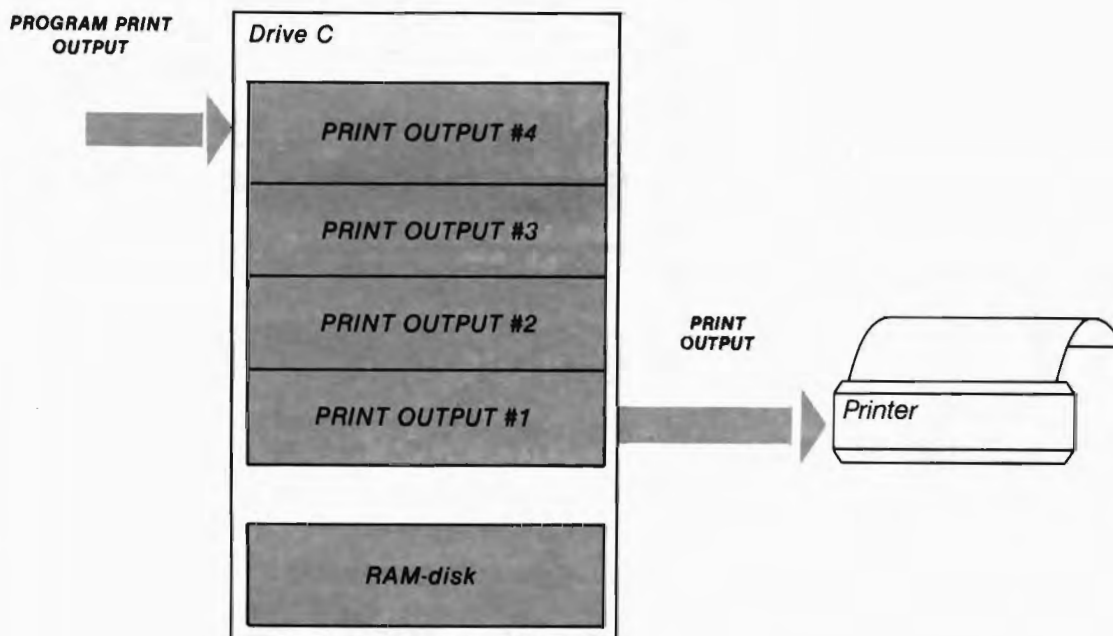

DCU W, R and Z work with both the Fixed Buffer and the Dynamic Buffer.



Using The Drive C Utility Program

5-19 USING DCU WITHOUT THE MENU

The SPACE option can be used without the full menu by typing DCU and the option letter 'S'.

Type 'X' to return to CP/M:

Please enter one of the above options: X

A>

The 'A' prompt

A>DCU S<CR>

Run DCU S from A:

ALL the DCU commands can be used without displaying the DCU menu.

The general rule is:

DCU FOLLOWED BY THE OPTION LETTER (S,O,W,R,Z) LETS YOU USE DCU DIRECTLY WITHOUT DISPLAYING THE MENU.

DCU S	SPACE
DCU O	OPTIMIZE
DCU W	WAIT
DCU R	RESTART
DCU Z	ZAP

Using The Drive C Utility Program



5-20 DCU E - ERASING THE RAM-disk

There are many times when you will want to erase ALL the files on the Drive C RAM-disk (for instance, if you wanted to reload a new set of files using QuickPac).

DC DEMO DISK

```
DCL      .COM
DCU      .COM
DFD      .SPR
PIP      .COM
XDIR     .COM
```

C:

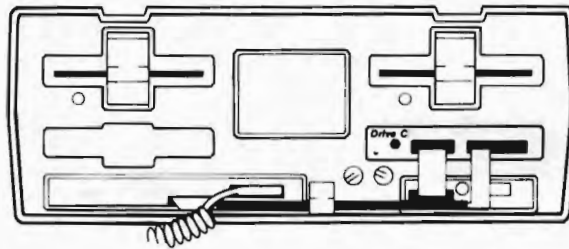

B:

DC USER DISK

```
DCN      .COM
DCU      .COM
Drive C: .SYS
PIP      .COM
PRN      .TST
```

```
A>ERA *.*<CR>
```

Erase ALL files on drive A:, the Drive C unit

```
All (Y/N)? Y<CR>
```

YES, Erase ALL

```
Bdos Err On A: File R/O
```

Cannot erase ALL because of a R/O (Read Only) file on drive A:

```
Bdos Err On A: File R/O ^C
```

^C to return to CP/M

```
A>
```

The 'A' prompt

The ERA *.* command will not work because of the R/O file, Drive C:..SYS.

A special command, DCU E (ERASE), will erase ALL of the files on the Drive C RAM-disk EXCEPT for Drive C:..SYS, even if any or all of these files are R/O.

DCU E is NOT part of the DCU menu. The ERASE option is only available in the form, DCU E.

```
A>DCU E<CR>
```

Run DCU E from A:

```
Erase all (including R/O) Drive C: files (Y/N)? Y
```

```
Are you sure (Y/N)? Y
```



Using The Drive C Utility Program

```
A>C:XDIR A:<CR>
```

Run XDIR on A:,
the Drive C unit, from C:

Drive A: is now blank with the exception of the Drive C:.SYS file.

DCU E will NOT erase the contents of the Print Buffer if you are printing.

DC DEMO DISK

DCL .COM
DCU .COM
DFD .SPR
PIP .COM
XDIR .COM

C:

B:

DC USER DISK

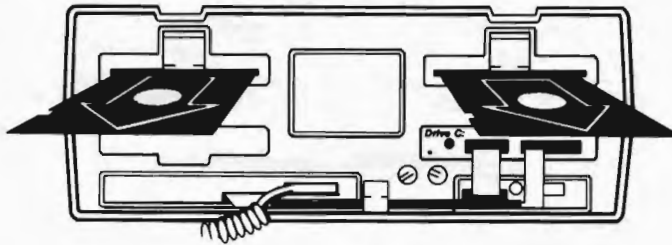

A:

Drive C: .SYS

Press the [RESET] button.

This completes the section on Learning the Drive C Skills.

Using Your New Drive C Skills



CONTENTS

USING QUICKPAC
SAVING Drive C FILES
MAKING IT EVEN MORE AUTOMATIC

This last section of the manual shows you how to use the Drive C features easily and automatically.

In this section you will learn how to use QuickPac to set up Drive C.

Several methods for saving Drive C files are demonstrated. The most powerful, ARCHIVE (DCA), can save files much larger than the storage capacity of a floppy diskette.

The RETRIEVE program (DCA R) reconstructs your Archived files onto Drive C.

Finally, powerful methods of combining QuickPac and RETRIEVE which make using Drive C even easier are discussed.

When you've finished this section, don't forget to check the APPENDICES for additional helpful hints.



Using QuickPac

CONTENTS

- 6-1 MAKING Drive C AUTOMATIC
- 6-2 DCQINS - INSTALLING THE QUICKPAC OPTIONS
- 6-3 USING QUICKPAC

6-1 MAKING Drive C AUTOMATIC

QuickPac (DCQ.COM) automatically installs any of the Drive C features, copies files onto the Drive C RAM-disk and even runs a program. QuickPac runs automatically each time you start your O1.

QuickPac Install (DCQINS.COM) is a menu-driven program that asks you which options you wish QuickPac to do. Your choices are stored in a special data file, DCQ.DAT, which is accessed later by QuickPac.

You can create a custom DCQ.DAT file for each set of application programs. For instance, you might create one DCQ.DAT file that copies WordStar and your WordStar document files onto Drive C, and another DCQ.DAT file that copies SuperCalc and your .CAL files

QuickPac will allow you to install the following options:

1. COPY THE CONTENTS OF ONE OR BOTH OF THE DISKETTES IN YOUR FLOPPY DRIVES ONTO Drive C
2. RENAME Drive C AS DRIVE A: OR DRIVE B:
3. INSTALL ANY OF THE NINE PRINT BUFFER SIZES
4. AUTOMATICALLY RUN A PROGRAM ON Drive C OR ON YOUR FLOPPY DRIVES

CP/M is set up to run any program named AUTOST.COM when you press <CR> after either initially turning on your Osborne or pressing the RESET button. To use QuickPac, DCQAUT.COM, the Drive C Autoloader, must be renamed AUTOST.COM.

PLEASE NOTE: You have many different AUTOST.COM files on your Osborne diskettes. Be sure not to mix up your AUTOST.COM files. They are not the same even though they have the same name.

In this section, you will use the QuickPac Install program to setup QuickPac to install Drive C as A: with the Dynamic Print Buffer, to copy your WordStar disk onto the Drive C RAM-disk and to run WordStar.

Using QuickPac



DC DEMO DISK

DCL .COM
DCU .COM
DFD .SPR
PIP .COM
XDIR .COM

A:

B:

DC USER DISK

DCA .COM
DCL .COM
DCQ .COM
DCQ .DAT
DCQAUT .COM
DCQINS .COM
DCU .COM
DFD .SPR
PIP .COM
PRN .TST
SYSGEN .COM
XDIR .COM

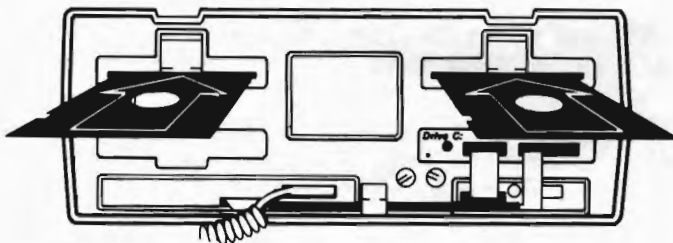

Drive C NOT INSTALLED

Press the [RESET] button

Press <CR> to load CP/M. The A> should appear on your screen.

A>

The 'A' prompt

A>PIP A:=B:DCQ*.*[V<CR>

Copy the DCQ (QuickPac) files
onto A: from B:

DC DEMO DISK

DCL .COM
DCQ .COM
DCQ .DAT
DCQAUT .COM
DCQINS .COM
DCU .COM
DFD .SPR
PIP .COM
XDIR .COM

A:

B:

DC USER DISK

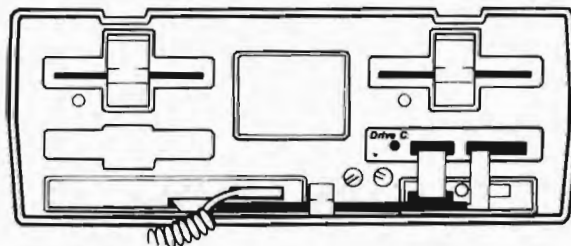

Drive C NOT INSTALLED



Using QuickPac

You'll find that QuickPac Install (DCQINS.COM) is easy to use and that with a little practice, you'll be creating a DCQ.DAT file tailored for each of your applications.

DCQINS is a program designed specifically to create your DCQ.DAT files. It can be run from your floppy drives or from Drive C.

The question of which drive(s) will be used arises three times during the QuickPac Install process: Where to store the DCQ.DAT file; which disks to copy onto Drive C; and which disk to run a program from.

STORAGE OF DCQ.DAT

ALWAYS NOTE the names of your drives at the time that you run DCQINS. The final step in using the QuickPac Install program is to store the DCQ.DAT file (which contains your QuickPac options) onto the diskette that you'll use for autoloading.

For instance, suppose your drives were renamed and your system looked like this before running DCQINS (NOTE: EXAMPLE ONLY, DO NOT DO) -

YOUR BOOT DISK

AUTOST	.COM
DCL	.COM
DCQ	.COM
DCU	.COM
DFD	.SPR
PIP	.COM
XDIR	.COM

C:

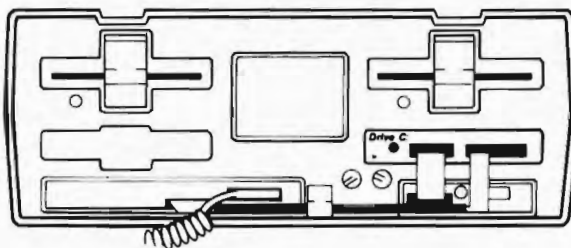

B:

SuperCalc Disk

AUTOST	.COM
BRIAN	.CAL
DCQINS	.COM
IAN	.CAL
INSTALLS	.COM
JAMES	.CAL
SC	.COM
SC	.HLP
SC	.OVL

A:

DCN	.COM	WS	.COM
DCU	.COM	WSMSG	.OVR
Drive C:	.SYS	WSOVL1	.OVR

DCQINS is run from the right-hand floppy, B: (B>DCQINS<CR>).

DCQINS will ask, " Do you want to store DCQ.DAT on drive A:, B: or C:?. ". DCQ.DAT should be stored on the disk you will later use for autoloading QuickPac. In this example, it is the left-hand floppy, C:, so you would answer 'C'.

Once you've started DCQINS, you CANNOT leave the program to check the CURRENT names of your drives without quitting DCQINS and starting over.

REMEMBER, THE NAME OF THE DRIVE WHERE YOU STORE DCQ.DAT IS DETERMINED BY HOW YOUR DRIVES ARE NAMED WHEN YOU RUN DCQINS.

A useful way to avoid confusion is to rename your system to its most "obvious" state before running DCQINS (using DCN).

A: Left-hand floppy

B: Right-hand floppy

C: Drive C

Using QuickPac



COPYING FILES

DCQINS will ask you, " Which disks do you want copied to Drive C? (A:, B: or both) ". Your answer will be recorded in the DCQ.DAT file which QuickPac will use.

When you run QuickPac (after power up or a RESET), QuickPac will copy the contents of the disk(s) you chose onto Drive C. At the time QuickPac does its copy operation, your floppy drives WILL ALWAYS HAVE THEIR ORIGINAL NAMES, just as if Drive C was not installed.

Therefore, when DCQINS is asking (for the copy operation) which drive name(s) to put in the DCQ.DAT file you are creating, ALWAYS refer to your drives as if Drive C was not installed. REMEMBER, you are instructing QuickPac what to do in the future using the DCQ.DAT file.

RUNNING A PROGRAM

Finally, QuickPac will let you run a program as an option to be specified in DCQ.DAT. DCQINS will not only ask you WHAT program to run but also on WHAT drive the program will be found. QuickPac will run the program as the last part of its autoloading sequence, after it has copied files AND after it has renamed your drives (if you have specified these options).

Again, you are instructing QuickPac what to do in the future using the DCQ.DAT file that you are creating with DCQINS. The name of the drive where your program will be is determined by how your DCQ.DAT renames your drives during the QuickPac autoloading procedure.

The rules are:

STORING DCQ.DAT	THE DRIVE NAMES AS THEY ARE WHEN RUNNING DCQINS
COPYING FILES	THE FLOPPY DRIVE NAMES AS IF Drive C WAS <u>NOT</u> INSTALLED
RUNNING A PROGRAM	THE DRIVE NAMES AS THEY WILL BE <u>AFTER</u> QuickPac RENAMES THE DRIVES

In the following section you will create a DCQ.DAT file using DCQINS. Please note how the different drive names are used.

**** IF YOU HAVE DIFFICULTY LATER STORING DCQ.DAT ****

After running DCQINS and storing DCQ.DAT, use DIR or XDIR to check that DCQ.DAT has been stored on the diskette you'll be using for autoloading QuickPac. You can check the contents of the DCQ.DAT file with a "TYPE DCQ.DAT<CR>" command.



Using QuickPac

6-2 DCQINS - INSTALLING THE QUICKPAC OPTIONS

DCQINS, the QuickPac Install program, is menu-driven. It lets you custom tailor QuickPac to fit your needs.

A>DCQINS<CR>

Run DCQINS (QuickPac Install)
from A:

The QuickPac Installation title screen will appear. Press any key to start DCQINS.

Pressing <ESC> will let you restart the QuickPac Install program or exit to CP/M. You can press <ESC> at any time.

QUICKPAC INSTALL - COPY DISKS

Do you want to copy disks to Drive C: (Y/N)? Y

This question asks whether you want QuickPac to copy the complete contents of either one or both of the floppy disks in your drives onto the Drive C unit.

Is your unit 384K (Large), or 192K (Small) (L/S)?

Please indicate the size of your Drive C unit, L for 384K, S for 192K.

If you have a 192K Drive C, the following question will appear:

Will your disks be Single or Double density (S/D)?

You will be using your WordStar diskette in this exercise, so please indicate the density of your WordStar diskette, S for single, D for double.

QuickPac asks this question to check that you don't try to copy two 185K Double-density diskettes onto a 192K Drive C.

Which disks do you want copied to Drive C:?

Disk A: or B: or both (A/B/2)? B

When QuickPac first copies onto the Drive C unit, Drive C is always named C:. QuickPac will rename Drive C (if you've so specified) only AFTER copying the disk files. THEREFORE, WHEN SPECIFYING WHICH DISKS TO COPY FROM, USE THE USUAL OSBORNE FLOPPY DISK DRIVE NAMES.

When you program your own QuickPac choices, you should answer A to copy the files from drive A:, B for drive B: or 2 to copy the contents of BOTH floppy diskettes. If you have a 192K Drive C and a double-density 01, you can answer only 'A' or 'B'.

Are the above choices correct (Y/N)? Y

If you've made an error in the copying instructions, QuickPac will let you start over if you answer 'N'.

Using QuickPac



QUICKPAC INSTALL - RENAMING THE Drive C RAM-disk

```
Do you want your Drive C: unit to become  
drive A:, drive B: or drive C: (A/B/C)? A
```

Answer A to name the Drive C unit drive A: for this exercise.

QUICKPAC INSTALL - INSTALLING THE PRINT BUFFER

```
Do you want to install the Print Buffer (Y/N)? Y
```

```
Please choose one of the above fixed buffer sizes  
or press (P) for the dynamic buffer: P
```

Any of the Fixed Buffers can be installed by typing the appropriate letter or the Dynamic Buffer can be installed by typing P. For this exercise, please type P.

QUICKPAC INSTALL - RUNNING A PROGRAM AUTOMATICALLY

```
Do you want to run a program (Y/N)? Y
```

```
On which disk drive will the program be (A/B/C)? A
```

This part of QuickPac allows you to specify a program to be run automatically. You must specify on which logical drive the program file is located. If you've renamed the drives, you must specify the FINAL, NEW name of the Drive C unit or the floppy drive where the program file is located.

```
Enter the command (i.e. WS YOURFILE.EXT<CR> ):  
>A:WS<CR>
```

The drive name you previously chose for the program is automatically inserted in the program command line. You've now told QuickPac to run WordStar from drive A:, the Drive C unit.

When you select your own program to run, you can enter any CP/M command line including Submit files. For example, SUBMIT TEST, MBASIC LEDGER or B:DBASE A:MAILIST.

QUICKPAC INSTALL - CREATING DCQ.DAT

```
You have chosen the above options.
```

```
If they are correct press <RETURN>.  
To change any options press <ESC>.
```

This screen shows you the choices you've made for QuickPac. If you've made a mistake, press the <ESC> key and try again. If your choices are correct, press <CR>.



Using QuickPac

Do you want to store DCQ.DAT on drive A:, B: or C:? A

The file, DCQ.DAT, contains the choices you made in DCQINS. DCQ.DAT is used by QuickPac to install Drive C with the options you've chosen.

DCQ.DAT must be stored on the diskette you will use for autoloading, i.e. the same diskette with AUTOST.COM (DCQAUT.COM) and DCQ.COM.

In this exercise, DCQ.DAT will be stored on the DC DEMO DISK in drive A:. Please note that creating the NEW DCQ.DAT file will overwrite the OLD DCQ.DAT file that is on the DC DEMO DISK.

Since you are storing DCQ.DAT now, you should use the name of the drive as it is named RIGHT NOW. In this case, it is the left-hand floppy, drive A:.

RUNNING QUICKPAC WITH YOUR NEW DCQ.DAT FILE

Before you can use QuickPac, DCQAUT.COM must be renamed AUTOST.COM.

A>REN AUTOST.COM=DCQAUT.COM<CR>

Change the name DCQAUT.COM to AUTOST.COM

A>ERA DCQINS.COM<CR>

Erase QuickPac Install

A>XDIR<CR>

Run XDIR from A:

DC DEMO DISK

A:

B:

DC USER DISK

AUTOST .COM
DCL .COM
DCQ .COM
DCQ .DAT
DCU .COM
DFD .SPR
PIP .COM
XDIR .COM

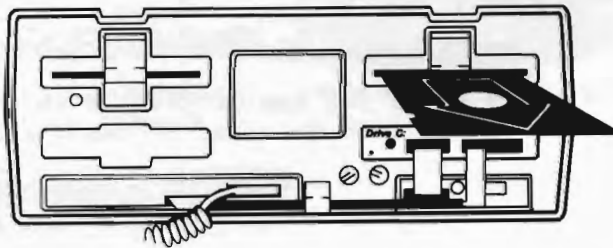

You are now ready to run QuickPac.

Using QuickPac



6-3 USING QUICKPAC

DC DEMO DISK

A:

B:

WordStar Disk

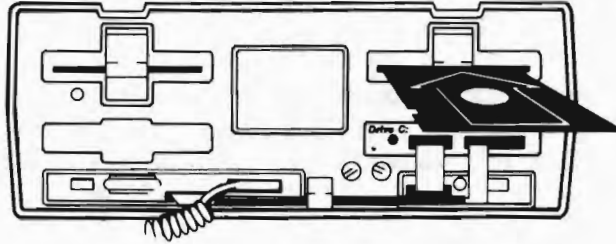

Drive C NOT INSTALLED

Press the [RESET] button.

When you press <CR>, your Osborne will automatically run the both AUTOST.COM program (originally DCQAUT.COM) and QuickPac (DCQ.COM) using the options you stored in the DCQ.DAT file.

You will find that QuickPac usually takes about one minute to load, copy one floppy disk to Drive C and run a program from Drive C.

Press <CR> to start QuickPac.

DC DEMO DISK

C:

B:

WordStar Disk

AUTOST .COM
 DCL .COM
 DCQ .COM
 DCQ .DAT
 DCU .COM
 DFD .SPR
 PIP .COM
 XDIR .COM

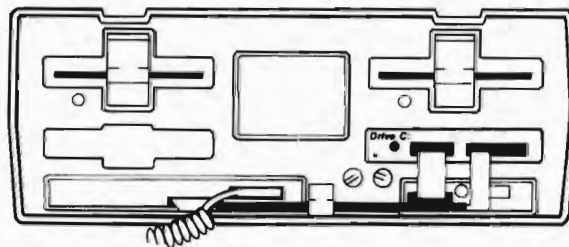

AUTOST .COM
 INSTALL .COM
 MERGPRIN .OVR
 SAMPLE .TXT
 WS .COM
 WSMGS .OVR
 WSOVL1 .OVR
 XDIR .COM

A:

AUTOST .COM MERGPRIN .OVR
 DCLOADED .SYS SAMPLE .TXT
 DCN .COM WS .COM
 DCU .COM WSMGS .OVR
 Drive C: .SYS WSOVL1 .OVR
 INSTALL .COM XDIR .COM

WordStar should now be running on drive A:, the Drive C unit.
 Press 'X' to EXIT WordStar.



Using QuickPac

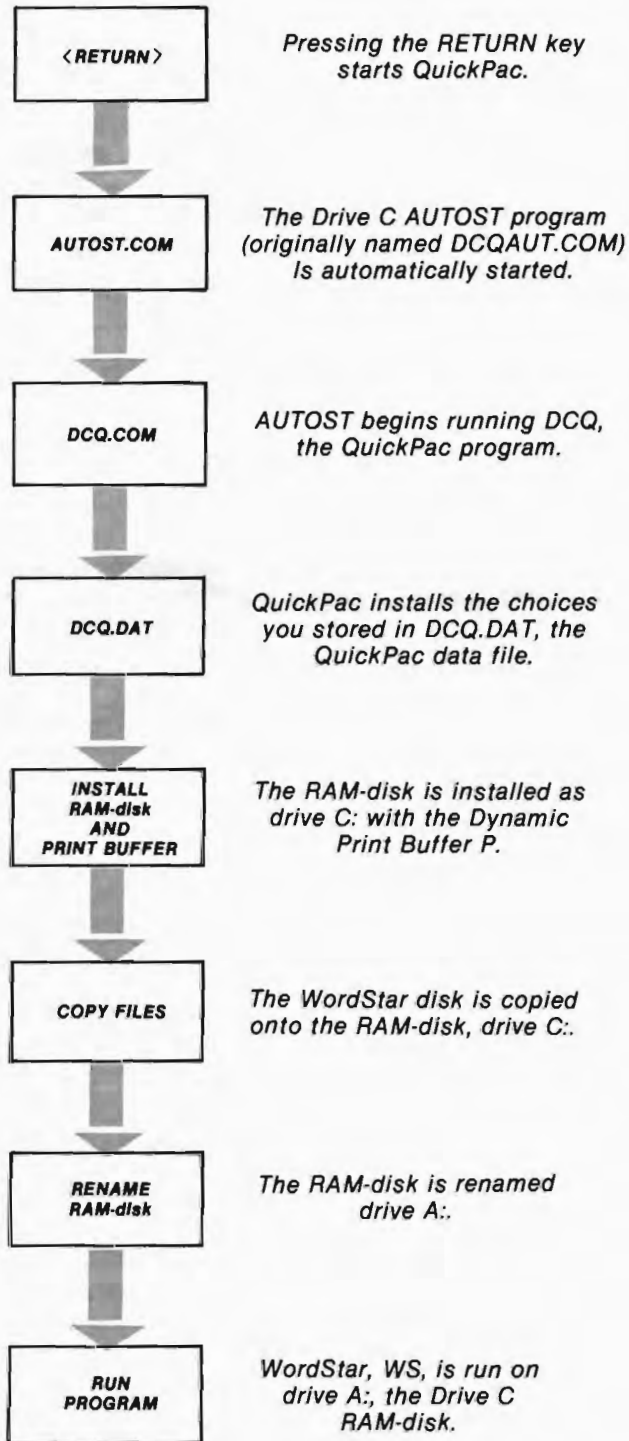

Using QuickPac



A> 'A' prompt

Press the [RESET] button.

QuickPac has copied the WordStar diskette onto A:, the Drive C unit.

There is a new file on the Drive C unit, DCLOADED.SYS. Whenever QuickPac automatically copies files onto Drive C, it also generates DCLOADED.SYS. If you specifically want to reload another set of programs and files onto your Drive C unit using QuickPac, you must first erase the DCLOADED.SYS file. You can use the ERA command or the DCU E command.

Press <CR> to start QuickPac a second time.

QuickPac now reinstalls ALL the same parameters as before but DOES NOT COPY the files from the diskette in B:.

The DCLOADED.SYS file alerts QuickPac that it had already copied the files and didn't need to do so again.

Press 'X' to EXIT WordStar.

A>DCU E<CR>

Run DCU E (Erase) from A: to erase ALL files on Drive C

Erase all (including R/O) Drive C: files (Y/N)? Y
Are you sure (Y/N)? Y

A>C:<CR>

Log onto C:

REN DCQAUT.COM=AUTOST.COM<CR>

Change the name AUTOST.COM back to DCQAUT.COM

DC DEMO DISK

C:

B:

WordStar disk

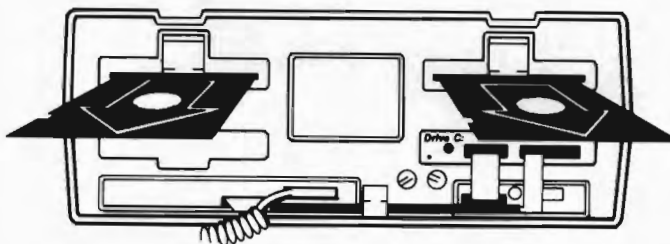

A:

This completes the section on QuickPac.



Saving Drive C Files

CONTENTS

- 6-4 GETTING READY
- 6-5 PROGRAMS WHICH COPY FILES
- 6-6 USING PIP
- 6-7 ARCHIVE
- 6-8 ARCHIVE - CHOOSING WHICH FILES TO STORE
- 6-9 ARCHIVE - STORING FILES ON FLOPPY DISK
- 6-10 THE ARCHIVE DISKETTE
- 6-11 USING AN ARCHIVE DISKETTE SET
- 6-12 ARCHIVE - SAVING ALL OF Drive C
- 6-13 RETRIEVE

When you've completed working with your Drive C files, they must be saved (backed up) onto floppy disks unless you are using BackPac. There are several ways to do this, depending on your application.

This section will demonstrate different ways to backup your Drive C, the most powerful being the Drive C ARCHIVE and RETRIEVE program (DCA.COM).

Saving Drive C Files



6-4 GETTING READY

You will need two blank, formatted diskettes.

FOR THIS EXERCISE, PLEASE FORMAT THESE DISKETTES SINGLE-DENSITY, EVEN IF YOU HAVE A DOUBLE-DENSITY OSBORNE.

Please label one of these diskettes BACKUP 1 and the other diskette BACKUP 2.

DC USER DISK

DCA	.COM
DCL	.COM
DCQ	.COM
DCQAUT	.COM
DCQ	.DAT
DCQINS	.COM
DCU	.COM
DFD	.SPR
PIP	.COM
PRN	.TST
SYSGEN	.COM
XDIR	.COM

A:

B:

WordStar DISK

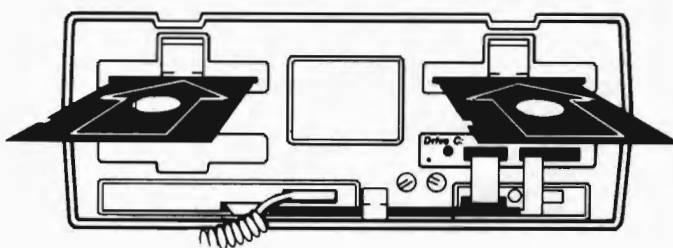

Drive C NOT INSTALLED

Press the [RESET] button.

Press <CR> to load CP/M. The A> should appear on your screen.

A>	'A' prompt
A>DCL A P<CR>	Install Drive C as A: with the Dynamic Print Buffer
C>PIP<CR>	Run PIP from C:
*A:=C:PIP.COM[V<CR>	Copy PIP.COM onto A:, the Drive C unit, from C:
*A:=C:XDIR.COM[V<CR>	Copy XDIR.COM onto A: from C:
*^C	^C to clear PIP
C>A:<CR>	Log onto A:, the Drive C unit
A>PIP A:=B:WS*.*[V<CR>	Copy the WordStar files onto A: from B:
A>	'A' prompt, the Drive C unit



Saving Drive C Files

DC USER DISK

DCA .COM
 DCL .COM
 DCQ .COM
 DCQ .DAT
 DCQAUT .COM
 DCQINS .COM
 DCU .COM
 DFD .SPR
 PIP .COM
 PRN .TST
 SYSGEN .COM
 XDIR .COM

C:

B:

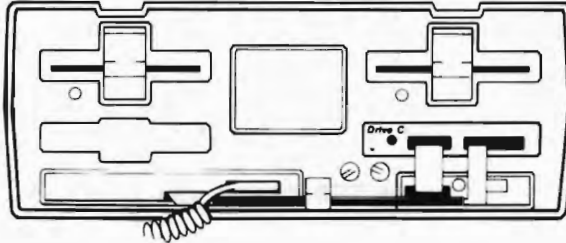

WordStar DISK

AUTOST .COM
 INSTALL .COM
 MERGPRIN .OVR
 SAMPLE .TXT
 WS .COM
 WSMGS .OVR
 WSOVLY1 .OVR
 XDIR .COM

A:

DCN .COM	WS .COM
DCU .COM	WSMGS .OVR
Drive C: .SYS	WSOVLY1 .COM
PIP .COM	XDIR .COM

DC USER DISK

C:

B:

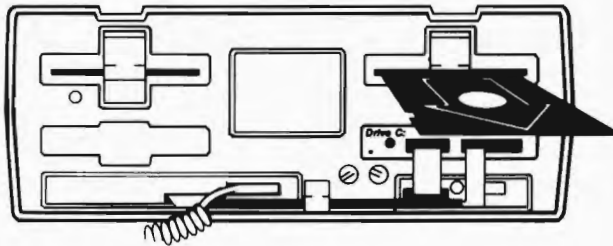

WordStar disk

A:

DC USER DISK

C:

B:

BACKUP 1 DISK

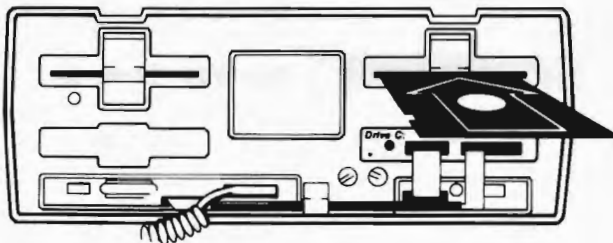

A:

Alt-C

^C to clear CP/M

Saving Drive C Files



6-5 PROGRAMS WHICH COPY FILES

Many application programs, like WordStar, have COPY options which will copy Drive C files onto your floppy disks.

Pressing the '0' option in the main WordStar menu starts the COPY procedure. Many application programs have options which let you copy files between your logical drives without leaving the application program.

```
A>WS<CR>
```

Run WS from A:

WordStar should now be running on drive A:, the Drive C unit. The main menu will be displayed.

Type '0' for the COPY option.

```
Name of file to copy from: XDIR.COM<CR>
```

```
Name of file to copy to: B:XDIRTEST.COM<CR>
```

DC USER DISK

C:

B:

BACKUP 1 DISK

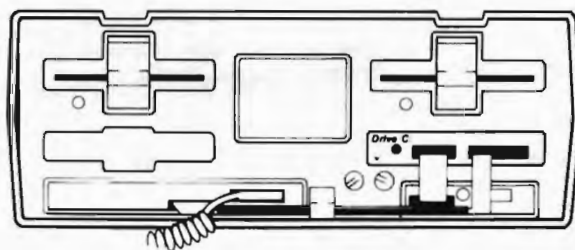

XDIRTEST .COM

A:

WordStar copied the XDIR.COM file from the Drive C unit onto the BACKUP 1 DISK in drive B:. You also used the WordStar COPY option to change the name of the saved file to XDIRTEST.COM.

Type 'X' to exit WordStar.

```
A>XDIR B:<CR>
```

Run XDIR on B: from A:

It's always prudent to use XDIR to confirm that the COPY operation was successful.

The WordStar COPY option can only copy one file at a time and requires typing each file name twice. PIP is much more flexible for copying a few files.



Saving Drive C Files

6-6 USING PIP

You've used PIP many times in these exercises to copy files.

PIP (or programs like SWEEP) will let you copy groups of files using a single command statement.

```
A>PIP B:PIPTEST.COM=A:PIP.COM[V<CR>
```

Copy PIP.COM onto B:,
the BACKUP 1 DISK
with the new name PIPTEST.COM
from A:, the Drive C unit

```
A>PIP B:=A:WS*.*[V<CR>
```

Copy the WordStar files onto the
BACKUP diskette from A:

DC USER DISK

DCA	.COM
DCL	.COM
DCQ	.COM
DCQ	.DAT
DCQAUT	.COM
DCQINS	.COM
DCU	.COM
DFD	.SPR
PIP	.COM
PRN	.TST
SYSGEN	.COM
XDIR	.COM

C:

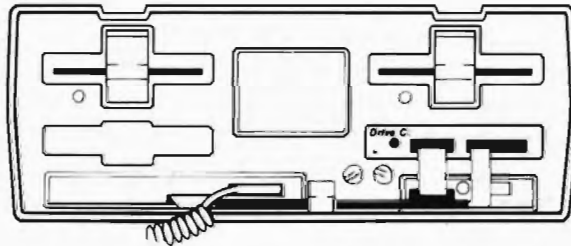

B:

BACKUP 1 DISK

PIPTEST	.COM
WS	.COM
WSMSG	.COM
WSOVLY1	.COM
XDIRTEST	.COM

A:

DCN	.COM	WS	.COM
DCU	.COM	WSMSG	.OVR
Drive C:	.SYS	WSOVLY1	.COM
PIP	.COM	XDIR	.COM

PIP is a very simple, effective means of backing up files from the Drive C unit onto floppy disks, especially if Drive C contains less than the contents of one floppy disk.

Saving Drive C Files



6-7 ARCHIVE

One of the major advantages of your Drive C is its ability to accommodate files much bigger than your floppy disks.

DCA.COM, the ARCHIVE and RETRIEVE program, lets you backup these big Drive C files onto a set of backup diskettes.

DCA is much faster than PIP, and can copy individual files and groups of files (like PIP) as well as the entire contents of the Drive C unit.

```
A>C:<CR>
```

Log onto C:

```
C>DCA<CR>
```

Run DCA from C:

```
ARCHIVE OR RETRIEVE (A/R)? A
```

ARCHIVE will store Drive C files onto any combination of single- and double-density diskettes.

You can Rerun or Exit ARCHIVE at any time by pressing the <ESC> key.

```
STORE ONTO FLOPPY (B/C)? B
```

ARCHIVE always knows the current name of your Drive C unit and will only let you backup files to one of your floppy drives, in this case drive B: or drive C:.

ARCHIVE uses a unique file format. When you save files onto floppy disk using ARCHIVE, you will NOT be able to use the files until they have been reloaded onto the Drive C unit using the RETRIEVE portion of DCA.

In order to easily identify your ARCHIVE floppy set, you need to enter up to 50 characters for the ARCHIVE SET LABEL. You MUST enter a label so that ARCHIVE can identify each ARCHIVE SET, but you do not have to use the full 50 characters available.

Helpful information can be entered as part of the LABEL, such as the date or even the time. It's a good idea to give each ARCHIVE SET a unique label so you won't have to worry about mixing different sets.

```
Enter LABEL:
```

```
[TEST SET DC EXERCISES<CR>
```

```
]
```



Saving Drive C Files

6-8 ARCHIVE - CHOOSING WHICH FILES TO STORE

The initial ARCHIVE menu is displayed:

```
<TAB>   Store ALL files (*.*)
<RETURN> Store specific files
<ESC>   Rerun or Exit
D       Directory of Drive C:
```

Please enter your choice. **D**

ARCHIVE can display a directory (like XDIR) of all the files on your Drive C unit and their sizes. You do not have to leave ARCHIVE in order to check the contents of Drive C.

```
FILES TO STORE: PIP.COM<CR>
FILES TO STORE: WS*.*<CR>
FILES TO STORE: <CR>
```

You've instructed ARCHIVE to copy PIP.COM and the WordStar files, WS*.* onto the backup diskette in B:.

PLEASE NOTE THAT THE CP/M FILENAME CONVENTIONS, LIKE WS*.*, WORK WITH ARCHIVE.

A <CR> in response to the FILES TO STORE: query will move you on to the next part of ARCHIVE.

After you've completed entering the files that you want to backup, the following menu will appear on your screen:

```
<RETURN> Begin storing files to floppy
<ESC>   Rerun or exit
D       Directory of Drive C:
L       List of files to be stored
U       Unselect files
S       Select more files
```

Please enter choice. **L**

A list of the files you've selected for backup and their sizes will appear. You can always check your selection using the L option before starting the actual copying process.

Saving Drive C Files



Please enter choice. **S**

The S option will let you SELECT additional files to backup in this set.

```
<TAB>   Store ALL files (*.*)
<RETURN> Store specific files
<ESC>   Rerun or Exit
D       Directory of Drive C:
L       List files to be stored
```

Please enter choice. <CR>

```
FILES TO STORE: XDIR.COM<CR>
FILES TO STORE: <CR>
```

Please enter choice. **L**

The LIST of selected files now includes XDIR.COM.

Please enter choice. **U**

```
<TAB>   Un-Store ALL files (*.*)
<RETURN> Un-Store specific files
<ESC>   Rerun or Exit
D       Directory of Drive C:
L       List files to be stored
```

Please enter choice. <CR>

```
FILES TO UN-STORE: PIP.COM<CR>
FILES TO UN-STORE: <CR>
```

The U option, UN-STORE, lets you remove files from the list of files to be transferred. This can be a very convenient tool.

Suppose you wanted to backup ALL the .DOC files EXCEPT ONE. You would store *.DOC and then UN-store the one you didn't want.

Please enter choice. **L**

The LIST option shows that PIP.COM will no longer be stored.



Saving Drive C Files

6-9 ARCHIVE - STORING FILES ON FLOPPY DISK

```
<RETURN> Begin storing files to floppy
<ESC>    Rerun or exit
D        Directory of Drive C:
L        List of files to be stored
U        Unselect files
S        Select more files
```

Please enter choice. <CR>

Pressing <RETURN> will now start the actual copying of files onto the backup diskette in drive B:.

Press <RETURN> to begin. <CR>

PLEASE INSERT ARCHIVE DISK #1 INTO FLOPPY DISK B:

Press <RETURN> to begin. <CR>

** THE FLOPPY DISK IS NOT BLANK **

Directory for floppy disk B:

ARCHIVE will store Drive C files on single- or double-density diskettes. If your diskettes are NOT BLANK, ARCHIVE must erase them before copying onto them.

In this case, a directory of the old files on the backup diskette will appear on the screen.

DC USER DISK

C:

B:

BACKUP 1 DISK

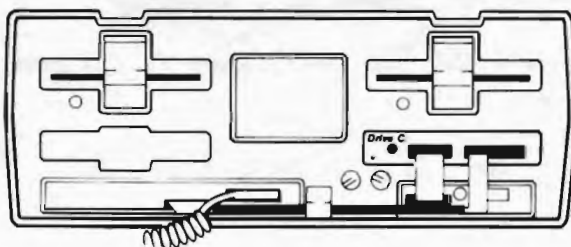

```
PIPTEST .COM
WS       .COM
WSMSGs  .COM
WSOVLY1 .COM
XDIRTEST .COM
```

A:

IF YOU DO NOT WANT TO KEEP THE OLD FILES ON YOUR BACKUP DISKETTE, ARCHIVE WILL ERASE ALL OF THEM AND USE THE DISKETTE FOR BACKUP.

IF YOU MADE A MISTAKE AND INSERTED A DISKETTE IN DRIVE B: THAT HAS FILES THAT YOU DON'T WANT ERASED, THIS CHECKING FUNCTION IN ARCHIVE ALERTS YOU.

Saving Drive C Files



To avoid deleting all the files on your backup diskette (and the possibility of a catastrophic mistake), all Drive C programs require you to confirm your decision to delete TWICE.

```
DELETE ALL THESE FILES (Y/N)? Y
```

```
<RETURN> Delete files and begin Archiving. <CR>  
(Press any other key to ABORT)
```

```
<RETURN> Delete files and begin Archiving.  
(Press any other key to ABORT) ** DELETING **
```

```
LIST OF FILES STORED:
```

ARCHIVE has deleted the files on the BACKUP 1 DISK and is now copying the files chosen onto drive B:.

The file names will be displayed as they are backed up.

Press <ESC> while ARCHIVE is storing files.

```
INTERRUPTED...
```

```
  C  Continue  
  R  Rerun  
  X  Exit to CP/M
```

The ARCHIVE process can be interrupted at any time and then resumed, restarted or aborted.

Press 'C' to continue.

```
LIST OF FILES STORED:
```

When the files you have specified have been stored, the following message appears:

```
ARCHIVE OPERATION COMPLETED.
```

```
Number of disks: 1
```

```
Files stored in this set: 4
```

```
C> 'C' prompt
```

ARCHIVE returns you to CP/M when its finished.



Saving Drive C Files

6-10 THE ARCHIVE DISKETTE

DC USER DISK

C:

B:

BACKUP 1 DISK

TESTSETD .AR1

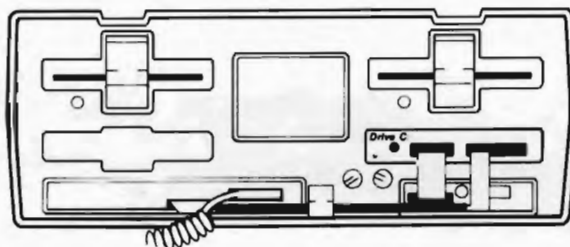

A:

```
⌘ XDIR B:<CR>
```

Run XDIR on B: from C:

The only file on the BACKUP 1 DISK is TESTSETD.AR1. ARCHIVE will create only ONE backup file which may contain many different CP/M files.

The name of the BACKUP file is the first eight characters in the SET LABEL (spaces in the SET LABEL are ignored).

In this case, the SET LABEL 'TEST SET DC EXERCISES' has become the name TESTSETD.

The file extension AR1 shows that this is the FIRST disk of an ARchive set.

If you had used more than one disk for your ARCHIVE SET, subsequent disks would have been automatically named TESTSETD.AR2, TESTSETD.AR3, etc.

```
⌘ TYPE B:TESTSETD.AR1<CR>
```

Use the CP/M TYPE command to look at the ARCHIVE file TESTSETD.AR1 on BACKUP 1 DISK

```
ARCHIVE DISK: TESTSETD.AR1
DISK #1
LABEL: TEST SET DC EXERCISES
$
```

```
⌘
```

'C' prompt

The TYPE command, a CP/M utility that's always available, will display the complete SET LABEL. This command lets you check an ARCHIVE disk in case you forgot to put a written label on it.

Saving Drive C Files



6-11 USING AN ARCHIVE DISKETTE SET

C>A:<CR>

Log onto A:

A>PIP A:=C:PRN.TST[V<CR>

Copy PRN.TST onto A: from C:

A>

'A' prompt

DC USER DISK

DCA .COM
 DCL .COM
 DCQ .COM
 DCQ .DAT
 DCQAUT .COM
 DCQINS .COM
 DCU .COM
 DFD .SPR
 PIP .COM
 PRN .TST
 SYSGEN .COM
 XDIR .COM

C:

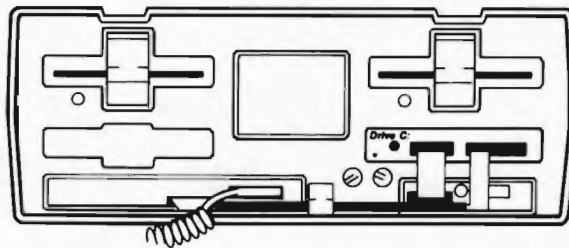

B:

BACKUP 1 DISK

TESTSETD .AR1

A:

DCN .COM WS .COM
 DCU .COM WSMGS .OVR
 Drive C: .SYS WSOVLY1 .COM
 PIP .COM XDIR .COM
 PRN .TST

There are now more files on Drive C than you can backup on one single-density diskette. ARCHIVE can automatically store ALL the files on Drive C onto a SET of backup diskettes.

A>C:<CR>

Log onto C:

C>DCA<CR>

Run DCA from C:

ARCHIVE OR RETRIEVE (A/R)? A

STORE ONTO FLOPPY (B/C)? B

Enter LABEL:

[TEST ALL DC EXERCISES<CR>



Saving Drive C Files

6-12 ARCHIVE - SAVING ALL OF Drive C

The initial ARCHIVE menu is displayed:

```
<TAB>   Store ALL files (*.*)
<RETURN> Store specific files
<ESC>   Return or Exit
D       Directory of Drive C:
```

Please enter your choice. <TAB>

Pressing <TAB> instructs ARCHIVE to copy ALL the files from Drive C onto as many backup diskettes as are necessary.

ARCHIVE will show that ALL the files on Drive C have been selected to be stored.

```
<RETURN> Begin storing files to floppy
<ESC>   Return or exit
D       Directory of Drive C:
L       List of files to be stored
U       Unselect files
S       Select more files
```

Please enter choice. <CR>

Pressing <RETURN> will now start the copying of ALL Drive C files onto the backup diskette in drive B:.

Press <RETURN> to begin. <CR>

Keep the BACKUP 1 DISK with the file TESTSETD.ARI on it in drive B: and have your other diskette, labeled BACKUP 2 DISK, available.

PLEASE INSERT ARCHIVE DISK #1 INTO FLOPPY DISK B:

Press <RETURN> to begin. <CR>

** THE FLOPPY DISK IS NOT BLANK **

Directory for floppy disk B:

TESTSETD.ARI

DELETE ALL THESE FILES (Y/N)? Y

<RETURN> Delete files and begin Archiving. <CR>
(Press any other key to ABORT)

LIST OF FILES STORED:

ARCHIVE has deleted TESTSETD.ARI from the BACKUP 1 DISK and is now copying ALL the contents of Drive C onto drive B:.

Saving Drive C Files



When the BACKUP 1 DISK is full, the following message will be displayed:

THIS ARCHIVE DISK IS FULL

**PLEASE INSERT DISK #2 INTO FLOPPY DISK B:
Press <RETURN> to begin.**

Remove the BACKUP 1 DISK from drive B: and insert the BACKUP 2 DISK into drive B:.

DC USER DISK

C:

B:

BACKUP 1 DISK

TESTALDD .AR1

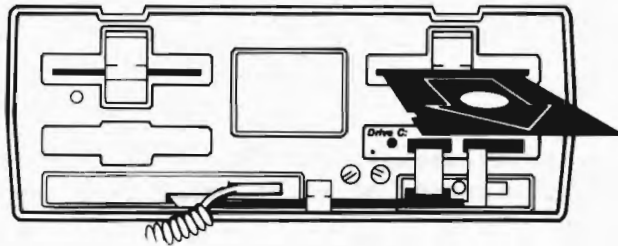

A:

DC USER DISK

C:

B:

BACKUP 2 DISK

Blank, formatted

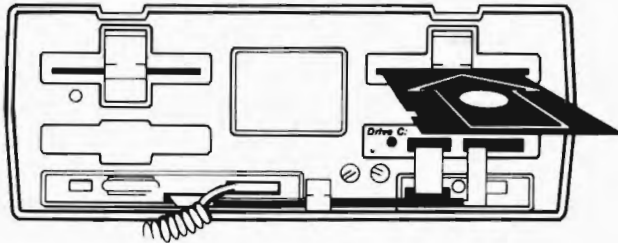

A:

DO NOT PRESS ^C WHEN CHANGING ARCHIVE DISKETTES.

**PLEASE INSERT DISK #2 INTO FLOPPY DISK B:
Press <RETURN> to begin. <CR>**

Pressing <CR> will cause ARCHIVE to continue storing files until ALL the files on Drive C have been saved.

When ARCHIVE is finished, you'll see the message:

**ARCHIVE OPERATION COMPLETED.
Number of disks: 2
Files stored in this set: 8**



Saving Drive C Files

C>

'C' prompt

DC USER DISK

C:

B:

BACKUP 2 DISK

TESTALLD .AR2

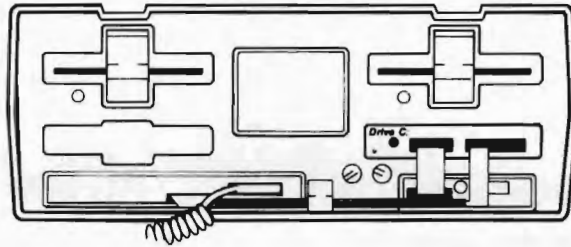

A:

It required two single-density diskettes to store ALL the files from Drive C. If there had been ONE big file instead of eight small files on Drive C, ARCHIVE would have automatically divided the large file and stored it on a series of ARCHIVE diskettes: TESTALLD.AR1, TESTALLD.AR2, TESTALLD.AR3 etc.

Saving Drive C Files



6-13 RETRIEVE

RETRIEVE reloads your ARCHIVE SET onto Drive C.

First, erase the contents of Drive C using the DCU E command.

```
⊞DCU E<CR>
```

Run DCU E (Erase) from A: to
erase ALL files on Drive C

```
Erase all (including R/O) Drive C: files (Y/N)? Y  
Are you sure (Y/N)? Y
```

```
⊞XDIR A:<CR>
```

Run XDIR from A:

DC USER DISK

```
DCA      .COM  
DCL      .COM  
DCQ      .COM  
DCQ      .DAT  
DCQAUT   .COM  
DCQINS   .COM  
DCU      .COM  
DFD      .SPR  
PIP      .COM  
PRN      .TST  
SYSGEN   .COM  
XDIR     .COM
```

C:

B:

BACKUP 2 DISK

```
TESTALD .AR2
```

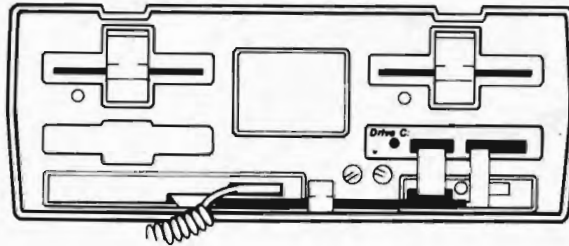

A:

Drive C: .SYS



Saving Drive C Files

C>DCA<CR>

Run DCA from C:

ARCHIVE OR RETRIEVE (A/R)? R

The RETRIEVE program, like ARCHIVE, knows the current name of the Drive C unit and will only let you RETRIEVE from the floppy drives, in this case B: and C:.

RETRIEVE FILES FROM FLOPPY DRIVE (B/C)? B

PLEASE INSERT ARCHIVE DISK #1 INTO FLOPPY DISK B:

FOR THIS EXERCISE, PLEASE INITIALLY LEAVE THE BACKUP 2 DISK IN DRIVE B:, EVEN THOUGH THE PROGRAM ASKS YOU TO INSERT ARCHIVE DISK #1.

Press <RETURN> to begin. <CR>

THIS IS NOT ARCHIVE DISK #1.

ARCHIVE DISK: TESTALLD.AR2

DISK #2

LABEL: TEST ALL DC EXERCISES

PLEASE INSERT ARCHIVE DISK #1 INTO FLOPPY DISK B:

Press <RETURN> to begin.

RETRIEVE required that your ARCHIVE SET be retrieved in order. The .AR1 diskette must be inserted first, then the .AR2 diskette, etc.

RETRIEVE also checked that the diskette you inserted was an ARCHIVE disk and NOT one of your program or data diskettes.

The program identified an incorrect diskette and asked you to insert another diskette.

Please now remove the BACKUP 2 DISK and insert the BACKUP 1 DISK.

YOU SHOULD NOT PRESS ^C WHEN CHANGING ARCHIVE DISKETTES.

DC USER DISK

C:

B:

BACKUP 2 DISK

TESTALLD .AR2

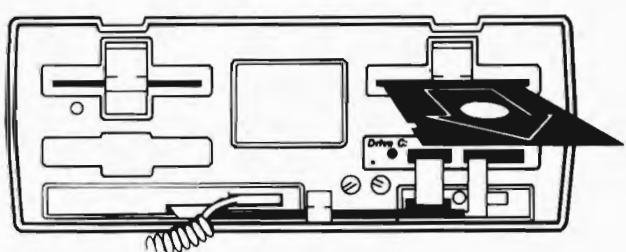

A:

Saving Drive C Files



DC USER DISK

C:

B:

BACKUP 1 DISK

TESTALLD .ARI

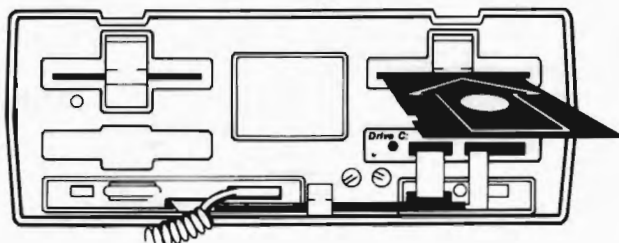

A:

**PLEASE INSERT ARCHIVE DISK #1 INTO FLOPPY DISK B:
Press <RETURN> to begin. <CR>**

**ARCHIVE DISK: TESTALLD.ARI
DISK #1
LABEL: TEST ALL DC EXERCISES**

**Press <RETURN> if Archive set is CORRECT
OR**

Insert another diskette and press <R> to RETRY. <CR>

Press <CR> and RETRIEVE will begin copying and reconstructing the Drive C files that were stored on this specific ARCHIVE SET.

RETRIEVE will query you even if you have inserted the #1 disk of an ARCHIVE SET to make sure that you are retrieving the correct ARCHIVE SET.

RETRIEVE will display the files it is reconstructing on Drive C as they are copied from the ARCHIVE diskette.

When all the information on the first ARCHIVE diskette has been retrieved, the following message will be displayed:

THIS ARCHIVE DISK HAS BEEN COMPLETELY RETRIEVED.

**PLEASE INSERT ARCHIVE DISK #2 INTO FLOPPY DISK B:
Press <RETURN> to begin.**

Remove the BACKUP 1 DISK from drive B: and insert the BACKUP 2 DISK into drive B:.

REMEMBER, DO NOT PRESS ^C WHEN CHANGING ARCHIVE DISKETTES.



Saving Drive C Files

DC USER DISK

C:

B:

BACKUP 1 DISK

TESTALLD .AR1

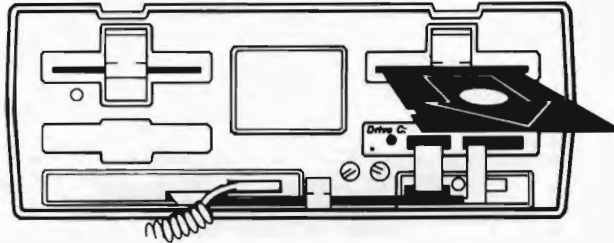

A:

DC USER DISK

C:

B:

BACKUP 2 DISK

TESTALLD .AR2

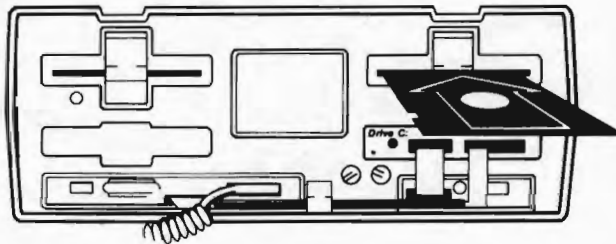

A:

PLEASE INSERT ARCHIVE DISK #2 INTO FLOPPY DISK B:
Press <RETURN> to begin. <CR>

Press <CR> and RETRIEVE will continue loading the files from the BACKUP 2 DISK, the second disk in the ARCHIVE SET.

When ALL of the ARCHIVE SET has been retrieved, this message will appear:

RETRIEVE OPERATION COMPLETED.
Archive diskettes read: 2
Files retrieved: 8

Saving Drive C Files



DC USER DISK

DCA .COM
DCL .COM
DCQ .COM
DCQ .DAT
DCQAUT .COM
DCQINS .COM
DCU .COM
DFD .SPR
PIP .COM
PRN .TST
SYSGEN .COM
XDIR .COM

C:

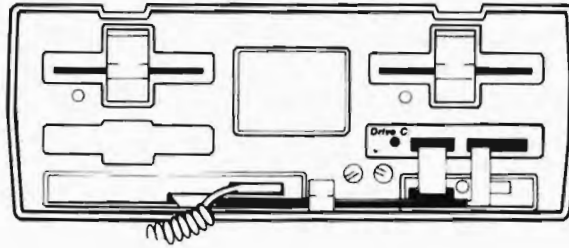

B:

BACKUP 2 DISK

TESTALD .AR2

A:

DCN	.COM	WS	.COM
DCU	.COM	WSMSG	.OVR
Drive C:	.SYS	WSOVL1	.COM
PIP	.COM	XDIR	.COM
PRN	.TST		

You can RETRIEVE onto Drive C even if there are already files on Drive C.

There must, however, be sufficient space on the Drive C RAM-disk for the retrieved files.

If there is not enough space, you will see the message:

```
Drive C: DISK SPACE IS FULL.  
In process of retrieving file: _____  
You must delete some files from Drive C: before  
attempting to retrieve this Archive set.  
PLEASE START RETRIEVE OPERATION OVER.
```

The RETRIEVE program can be run automatically. This is discussed in the next section, "Making It Even More Automatic".



Making It Even More Automatic

CONTENTS

- 6-14 USING YOUR FUNCTION KEYS
- 6-15 THE REMOTE RETRIEVE COMMAND
- 6-16 REMOTE RETRIEVE WITH QUICKPAC

6-14 USING YOUR FUNCTION KEYS

Placing several Drive C commands on your function keys can make using Drive C very simple no matter what your application.

Some suggestions are:

DCL __ <CR>	The Drive C LOAD command with your choice of names and Print Buffer
DCN __ <CR>	The Drive C NAME command
DCU E<CR>	The Drive C ERASE command
DCU _	Any of the DCU Utility commands

Another command which is can be used to great benefit as a function key is the remote RETRIEVE command.

Making It Even More Automatic



6-15 THE REMOTE RETRIEVE COMMAND

Typing `DCA R<CR>` will automatically load the RETRIEVE function.

RETRIEVE will then ask from which drive to retrieve.

Even more powerful is the `DCA R A, B or C` command. These commands will immediately begin retrieving without any inputs from you.

The general rule is:

RETRIEVE WILL WORK AUTOMATICALLY USING THE COMMAND `DCA R` FOLLOWED BY THE LETTER OF THE DRIVE WHICH HAS THE ARCHIVE DISKETTE.

THE DRIVE MUST CONTAIN DISK #1 OF AN ARCHIVE SET.

`DCA R A` will retrieve from drive A:

`DCA R B` will retrieve from drive B:

`DCA R C` will retrieve from drive C:

The most powerful combination is the remote RETRIEVE command with QuickPac.



Making It Even More Automatic

6-16 REMOTE RETRIEVE WITH QUICKPAC

RETRIEVE is a much faster means of loading Drive C than PIP.

To use the remote retrieve command with QuickPac, setup your DCQ.DAT file using QuickPac Install as follows:

1. DO NOT PROGRAM QUICKPAC TO COPY FILES FROM EITHER FLOPPY DISK.
2. SPECIFY THE PROGRAM TO RUN AUTOMATICALLY AT THE END OF QUICKPAC AS: DCA R _.

DC USER DISK

DCA .COM
DCL .COM
DCQ .COM
DCQ .DAT
DCQAUT .COM
DCQINS .COM
DCU .COM
DFD .SPR
PIP .COM
PRN .TST
SYSGEN .COM
XDIR .COM

C:

B:

BACKUP 1 DISK

TESTALLD .AR1

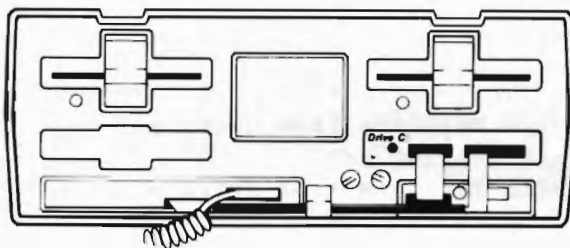

A:

In the above illustration, QuickPac was instructed to install Drive C as A:

The DCA.COM file is on C:, so the program to be run by QuickPac is C:DCA R B<CR>.

QuickPac would automatically load Disk #1 of the ARCHIVE SET, TESTALLD.AR1.

If you use the same group of programs and data files over and over, you will find it beneficial to create an ARCHIVE SET of these files and quickly load them onto your Drive C using the QuickPac remote retrieve feature.

Appendices



CONTENTS

- 7-1 Using Drive C with O1 System Utilities
- 7-2 Drive C hardware specifications
- 7-3 Drive C software specifications
- 7-4 Disk and RAM space usage with Drive C
- 7-5 Centronics parallel printer cable specifications
- 7-6 Patching WordStar for improved printing
- 7-7 Modifying QuickPac data files
- 7-8 Using ZCPR with Drive C

7-1 USING Drive C WITH O1 SYSTEM UTILITIES

There are four programs supplied with your Osborne 1 which were written specifically for your O1 and which assume that your computer has just two floppy disk drives.

You must follow a few special rules when using these programs.

COPY

COPY assumes that you have just two floppy drives named A: and B:.

To use COPY with Drive C installed you must NOT rename the drives. The floppy drives MUST be named A: and B: and the Drive C unit must be logical drive C: while you use copy. You can use the Drive C command "DCN C" to rename the drives at any time to be properly configured for COPY.

The RULES are:

TO USE COPY, THE FLOPPY DRIVES MUST BE NAMED A: AND B:.

THE DRIVE C UNIT MUST BE NAMED C:.

COPY CANNOT BE USED TO COPY FILES ONTO THE Drive C UNIT.

SETUP

SETUP, unlike COPY, ALWAYS assumes that drive A: and drive B: are the floppy disk drives, whether or not you have installed Drive C.

Typically, the left-hand floppy drive is initially drive A: and the right-hand floppy drive is drive B:. In this case, if you "tell" SETUP to get the CP/M System from drive A:, it will get it from the left-hand floppy REGARDLESS of the names of the logical drives.



Appendices

SETUP cannot get the CP/M system from the Drive C unit since the system can only be stored on floppy.

The RULES are:

SETUP ASSUMES THE NAMES OF THE FLOPPY DRIVES ARE NEVER CHANGED BY THE Drive C SOFTWARE.

SETUP ASSUMES THE LEFT (OR BOOT) FLOPPY IS DRIVE A: AND THE RIGHT (OR OTHER) FLOPPY IS DRIVE B:, WITH OR WITHOUT Drive C INSTALLED.

SYSGEN

SYSGEN works just like SETUP. It ALWAYS assumes that the floppy disk drive names have never been changed.

SYSGEN cannot get the CP/M system from the Drive C unit since the system can only be stored on floppy.

The RULES are:

SYSGEN ASSUMES THE NAMES OF THE FLOPPY DRIVES ARE NEVER CHANGED BY THE Drive C SOFTWARE.

SYSGEN ASSUMES THE LEFT (OR BOOT) FLOPPY IS DRIVE A: AND THE RIGHT (OR OTHER) FLOPPY IS DRIVE B:, WITH OR WITHOUT Drive C INSTALLED.

MOVCPM

MOVCPM must be run BEFORE running the Drive C Loader, DCL.COM. MOVCPM will become confused if you run it after installing Drive C because it cannot tell that Drive C has altered the System. This confused condition will usually generate a MOVCPM "Synchronization Error".

The RULE is:

RUN MOVCPM BEFORE RUNNING DCL.COM, THE Drive C LOADER.

Appendices



7-2 Drive C HARDWARE SPECIFICATIONS

MECHANICAL SPECIFICATIONS

Dimensions (not including cables): 5.6in x 5.9in x 1.0in (14 cm x 15 cm x 2.5cm)

Weight: 1 lb (.45 kg)

Shipping Weight: 3 lbs. (1.4 kg)

Operating Temperature Range: +5 to + 60 degrees C (+40 to +140 degrees F)

Storage Temperature Range: -20 to +100 degrees C (-5 to +212 degrees F)

ELECTRICAL SPECIFICATIONS

Power Requirements: 11 to 14.5 VDC at 0.3A max. (2.5 Watts nominal, 384K unit)

Source: Draws power from the 01 EXT. VIDEO connector or from the optional Drive C BackPac backup power supply.

PERFORMANCE SPECIFICATIONS

Latency time: NONE (Drive C is solid state and has no moving parts)

Maximum data throughput rate: 55,000 bytes per second
(445,000 bits per second)

Access time to random sector: approx. 40 usec. (software access time)

Time required to load 32K byte .COM file and run it: 1.1 seconds max.



Appendices

7-3 Drive C SOFTWARE SPECIFICATIONS

CP/M PARAMETERS

	<u>192K UNIT</u>	<u>384K UNIT</u>	<u>TURBOPAC</u>
Useful Storage Capacity:	187 KB	376 KB	10, 20 OR 33 MB
Block Size:	1K	2K	8K (can be modified)
Number of Directory Entries:	64	128	512 per logical drive
Directory Space:	2048 bytes	4096 bytes	16384 bytes per drive
Number of Logical Sectors:	1536	3072	varies with Block size & capacity
Number of Reserved Tracks:	0		612 landing area
Number of logical sectors/track:	2		32
Bytes per sector:	128		256
Amount of TPA RAM used:			
WITHOUT Print Buffer Installed:	1152 Bytes		
WITH Print Buffer Installed:	2176 Bytes		
when used with TurboPac hard disk:	3172 Bytes		

PRINT BUFFER SPECIFICATIONS

Installation: Automatically installed with Drive C RAM-disk loader. User can select NO buffer if desired.

Buffer Modes: Two, user selectable.
Dynamic or Fixed.

TurboPac Spool Buffer: 128K fixed capacity when used with 384K Drive C
not installed when used with 192K Drive C

Fixed Buffer Capacity: User selectable from 16K to 128K
in increments of 16K.

Dynamic Buffer Capacity: Up to the maximum space available
on the Drive C unit.

Print Buffer Speed: Input from CP/M via control P, limited by display speed
Input from PIP LST: Command, about 1250 characters per second
Output speed limited by printer.

Appendices



7-4 DISK AND RAM SPACE USAGE WITH Drive C

A certain amount of disk space is required on Drive C for the unit to function properly. Space is required for the disk directory and for two or three Drive C special files.

DISK SPACE USED		
<u>Function</u>	<u>Small Drive C (192K)</u>	<u>Large Drive C (384K)</u>
Directory space	2K needed	4K needed
DFD.SPR file	3K needed	4K needed
DCN.COM program	1K optional	2K optional
DCU.COM program	10K optional	10K optional
totals	<u>5K min. needed</u> 16K incl. options	<u>8K min. needed</u> 20K incl. options

NOTES: The DFD.SPR file is absolutely necessary to Drive C operation. It's located in user area 15. DO NOT ATTEMPT TO ERASE DFD.SPR FROM USER AREA 15. This file is loaded each time you type ^C and each time a program exits to CP/M. The file name has no significance, but DCL always checks for its existence each time DCL is run. The Drive C software automatically loads the DFD.SPR file to replace the Ol Digital Research CCP which would normally be loaded from the drive A: floppy disk after each ^C.

In applications where you need every last bit of disk space you may want to erase the "optional" programs DCN.COM and DCU.COM. The functions of these programs are explained (again) below.

DCN.COM is needed only if you want to rename the drives after running DCL. The DCN.COM program file is created by DCL at the time DCL is run.

The DCU.COM program is a utility copied automatically by DCL to the Drive C unit when DCL is run. If you don't need these utility functions, or if you are not using the Print Buffer feature, you can erase this file.

RAM SPACE USED

The Drive C software requires 1152 bytes of RAM space out of the Ol's total of 64K. The Print Buffer feature requires an additional 1024 bytes of RAM. However, the RAM needed by the Print Buffer is not used unless you install the Buffer at the time you run DCL.COM.

In applications using all of the available Ol TPA RAM (for example, DeskTop Accountant by Rocky Mountain Software) you may find you will need to eliminate the Print Buffer to get the application program to load.



Appendices

7-5 CENTRONICS PARALLEL PRINTER CABLE SPECIFICATIONS:

Cables manufactured exactly as specified in the Osborne 1 User's Manual will always work fine with Drive C. Unfortunately, many cable builders include an extra signal line which is never used by the O1 computer.

This signal, called 'PE' for Paper out Error, will interfere with normal Drive C operation if connected and MUST be removed to guarantee compatibility among your O1, Drive C unit and printer. If present, this signal wire will be connected FROM pin 12 (PE) on the 36-pin connector at the Printer end of the cable to pin 13 (NRFD) on the 26-pin edge connector at the Drive C end.

A properly built cable will have these signal connections:

Drive C unit PRINTER/HARD DISK/8088 Connector pin numbers	Centronics Signal name	Centronics-style Printer Connector pin no.s
1	Data bit 0	2
2	Data bit 4	6
3	Data bit 1	3
4	Data bit 5	7
5	Data bit 2	4
6	Data bit 6	8
7	Data bit 3	5
8	Data bit 7	9
10	Ground	30 (see Note 1 below)
11	Output Strobe	1
15	Printer Busy	11
16	Ground	29
18	Ground	21
20	Ground	20

Note 1. There are several signal ground connections on both Drive C and Printer ends of the cable. Your cable may have one or two connections less than shown here.

In general, more ground connections are better and it doesn't really matter which Ground pin on the Centronics printer end is connected to which Ground pin on the Drive C end.

Note 2. Some O1 printer cables also have a wire connecting Centronics pin 13 (SLCT OUT) to Drive C pin 19 (SRQ). This signal is NOT used by your O1, BUT it has NO effect on Drive C. If this wire is connected in your cable, leave it connected.

Ground Connection pin numbers:

Drive C 26-pin edge connector: 12,14,16,18,20,22,23,24

Centronics 36-pin connector: 19 through 30 (some printers have even more)

Appendices



7-6 PATCHING WORDSTAR FOR IMPROVED PRINTING:

Both versions 2.26 and 3.3x for the Osborne 1 and Osborne Executive have NOT been set up by MicroPro Int'l or OCC for efficient print while editing. If you have tried to edit a file while printing another file you may have noticed (especially with Centronics parallel printers) periods when your keyboard seems to be locked up and WordStar misses characters you type.

This condition is caused by the CP/M list output function (LST:) which will wait until the printer is ready (no matter how long) to output a character. Once WordStar outputs a character to the LST: routine CP/M will not return to WordStar for any other function until that character has been accepted by the printer.

The Drive C Print Buffer feature can eliminate most, but not all, of this annoying WordStar problem. To eliminate this problem entirely a modification to WS.COM is required. We have listed a patch below which you can install in WordStar yourself to implement the List Status function.

WordStar has a built-in ability to use the CP/M function called List Status, but this function has not been installed in the standard OCC versions of WordStar. When using the List Status function WordStar can check the printer to see if it's ready before actually sending out a character to be printed. This function virtually eliminates the annoying WordStar hang-ups when simultaneously editing and printing.

Please do NOT attempt to install this patch unless you are thoroughly familiar with the DDT utility and the SAVE command.

This procedure assumes you have DDT.COM, STAT.COM and WS.COM on the same drive. You MUST patch WS.COM AFTER you have installed it using the INSTALL or WINSTALL programs supplied with your version of WordStar. Otherwise the installation programs may erase these patches. Similarly, each time you re-install WordStar you have to re-do these patches.

1. Use STAT.COM to determine the number of records in your WS.COM file, using the command STAT WS.COM. WS version 2.26 is usually 126 records, WS version 3.3 is usually 138 records long. You will need this number later on in step 8. WS2.26 has an extra NOP instruction at the first patch location, as shown below.
2. Give the command DDT WS.COM<CR> to load DDT and WS.COM into memory.
3. List address 0718(hex): -L0718,071C<CR>

If the List Status patch has NOT been made yet you should see:

<u>Version 3.3</u>	0718 NOP	<u>Version 2.26</u>	0718 NOP
	0719 NOP		0719 NOP
	071A ORA A		071A NOP
	071B RET		071B ORA A
	071C MOV E,A		071C RET

-



Appendices

If the patch has ALREADY been installed you should see:

<u>Version 3.3</u>	0718 RST 07	<u>Version 2.26</u>	0718 RST 07
	0719 JMP 02E0		0719 NOP
	071C MOV E,A		071A JMP 02E0 (or another address)
			071D MOV E,A

4. Check the WordStar user patch areas to see if they are available:

-D02E0<CR> if the 16 bytes after address 02E0 are all 00 it's OK to put the patches at this standard address. If not, any area between 02E0 and 035B will do if available.

5. Use the in-line assembler of DDT to install the patch as follows:

Version 3.3	-A0718<CR>	<u>Version 2.26</u>	-A0718<CR>
	0718 RST 07<CR>		0718 RST 07<CR>
	0719 JMP 02E0<CR>		0719 NOP<CR>
	071C<CR>		071A JMP 02E0<CR>
			071D <CR>

-A02E0<CR> (This part is the same for BOTH versions)
02E0 CALL 02EB<CR>
02E3 INR A<CR>
02E4 JNZ 02E9<CR>
02E7 STC<CR>
02E8 RET<CR>
02E9 ORA A<CR>
02EA RET<CR>
02EB LHLD 0001<CR>
02EE MVI L,2D<CR>
02F0 PCHL<CR>
02F1 <CR>
-

6. Now check the code you have entered using the L0718 and L02E0 commands to make sure the result is exactly what you entered.

7. Exit DDT using the GO command or ^C.

8. After the A> prompt give the command: SAVE nn WS.COM<CR>

nn stands for a decimal number equal to half the number of records you determined for WS.COM in step 1. For example:

If your WS.COM file has 126 records, nn= 63
if it has 138 records, nn= 69
if it has 131 records, nn= 66 (Note, round up after dividing records by 2)

9. You're done! Go ahead and use your newly patched WordStar. If it works fine be sure to save it on floppy.

Appendices



7-7 MODIFYING QUICKPAC DATA FILES

This section is recommended for users who already know how to use SUBMIT. It is not intended as a tutorial on SUBMIT. The Drive C QuickPac program set consists of:

1. AUTOST.COM Drive C's own version, not to be confused with OCC versions. Also called DCQAUT.COM on the DC LOADER & ARCHIVE diskette.
2. DCQ.COM A program to implement several special Drive C functions
3. DCQ.DAT A data file similar to a .SUB file used by SUBMIT.COM
4. DCQINS.COM A menu-driven program to make setting up QuickPac options easy.

This section discusses how DCQ.COM works and how to modify the DCQ.DAT file in case you want to add extra operations to the usual QuickPac startup procedure.

AUTOST is called automatically by CP/M just after you boot-up. It works similarly to SUBMIT except that our AUTOST can only use a file called DCQ.DAT for its source.

A typical DCQ.DAT file (in this case, the one provided on your original ARCHIVE & LOADER Disk) looks like this, explanations for each line are on the right:

DCL	Run the Drive C Loader without Print Buffer
DCQ T + 1	Transfer files if not already transferred,
PIP C:=A:*.*[WVOR]	using PIP to move from drive A: to drive C:
DCQ N A + A:XDIR	Rename Drive C to drive A:, then run XDIR on new A:

If you want to add command lines to this file you can edit it using the Non-Document mode of WordStar. You can add just about any command lines you choose BEFORE the DCL line, e.g. you might run the user group program FAST.COM.

Generally, if you want to run a program which modifies the CP/M system in some way, you should run these programs BEFORE DCL. Generic CP/M programs which will access the Drive C unit should be added AFTER the "DCQ T + n" line.

Do NOT add any command lines after the last line containing a DCQ statement. Any such lines will be ignored, or, in some cases, may cause improper DCQ operation.

The rules for DCQ command syntax are simple:

1. **DCQ T + n** means: "If there is a file on the Drive C unit named DCLOADED.SYS, then skip n lines in this file to the next command line. If no such file exists execute the next line, and create the DCLOADED.SYS file on the Drive C unit."

This operation prevents QuickPac from copying all your files over from floppy to Drive C if you have already done so but are forced to reload and reboot CP/M.

Note: T stands for Transfer.



Appendices

2. **DCQ N d + A:XDIR** "Rename the Drive C unit to logical drive d: (d MUST be the letters A, B or C). Next display a message and beep the 01 beeper. Then run a program called A:XDIR."

Note: **N** stands for re-Name.

3. **DCQ N d +** "Rename the Drive C unit to drive d:. Then display a message and beep the 01 beeper. QuickPac exits to CP/M without running another program."

GENERAL RULES TO FOLLOW:

To add command line(s) BEFORE the first line (the one with DCL in it):

1. You can add any number of lines before the DCL line as long as the commands specified are the type which will return to CP/M immediately after execution.

2. Do NOT specify commands before the DCL command line which attempt to access the Drive C unit since Drive C is not installed until DCL runs.

To add a command to be executed only if QuickPac is running the first time, i.e. if DCLOADED.SYS is NOT already on the Drive C unit:

1. Add your command line(s) in between the "DCQ T + n" line and the "DCQ N" line, either before OR after the PIP line.

2. Change the number n to reflect the number of commands lines you added. If you added just one line, change n from 1 to 2. If you added two lines, change n from 1 to 3.

To change the program to run at the end of QuickPac:

1. Use DCQINS.COM to change this option.

To change the disks to be copied to the Drive C unit:

1. Use DCQINS.COM to change this option.

To install the Print Buffer at load time:

1. Use DCQINS.COM to change this option.

LOGGED-IN DRIVE:

Normally, if you run DCL manually, you remain logged-on to the same physical drive you ran DCL on. Since DCL can only be run from your initial floppy drive A:, you will still be logged-on to that floppy after running DCL.

If QuickPac runs a program, DCQ always logs onto the drive the program is on.

If QuickPac does not run a program but transfers files, DCQ logs onto the Drive C unit, regardless of its logical drive name.

Appendices



7-8 USING ZCPR WITH Drive C

This section is recommended reading only for user's familiar with some of the mysterious inner workings of CP/M and with assembly language programming.

One of the more popular enhancements available for the O1 from the FOG User Group (or CP/M User Group) is the set of CCP replacements known as ZCPR. These CCP's are all written in Z-80 code instead of the less efficient 8080 code used by Digital Research in order to add several useful commands.

The DCL Loader used with Drive C requires the presence of a file called DFD.SPR on your system disk used for initial boot-up of CP/M. This file is actually a replacement for the Digital Research CCP you got with your O1 and is derived from the ZCPR version known as NEWCCP. To maintain compatibility with Digital Research and OCC documentation we have made DFD.SPR as close as possible to the DRI standard.

You may notice that, once you load Drive C with DCL, the ERA command will echo all files erased to the console display. This is the only ZCPR feature we have left in DFD.SPR.

We have also created an expanded version (called DFDZCPR.SPR) which we have placed in the FOG library where it is accessible to all User Group members. We have not modified the NEWCCP commands at all in this version.

IMPORTANT NOTE: Drive C cannot support the expanded ZCPR-compatible version with phone calls or documentation of any kind.

You can create your own CCP files by:

1. keeping them exactly within 2048 bytes maximum size.
2. assembling them with Digital Research's RMAC.COM assembler (RMAC.COM is provided with all Osborne Executive computers and other CP/M Plus systems.)
3. using Digital Research's LINK.COM to link the output of RMAC to a .SPR file.
Example command: LINK NEWCCP [OS]
4. renaming whatever .SPR file you have created to DFD.SPR
5. replacing the original DFD.SPR file provided by Drive C on the LOADER & ARCHIVE Disk with the newly created ZCPRxxx version. You MUST name whatever version you use DFD.SPR in order for it to load properly with DCL.

Index

<u>Item</u>	<u>Page</u>	<u>Item</u>	<u>Page</u>
Archive -		DCA.COM (cont'd)	
SEE DCA.COM		Diskette.....	118
AUTOST.COM.....	100,104-105	Exiting to CP/M.....	114
BackPac.....	7-8	Interrupting.....	117
Backup -		LABEL.....	113,118
SEE Saving files		Redo.....	114
Backup Disk.....	109	Set.....	7-8,40-41, 119-122
Block size.....	134	Storing Files.....	116-122
Cables		Storing ALL files....	120-122
Ext. Video/Battery.....	11-13,15-16,27	TAB.....	120
Parallel printer		Un-selecting files....	115
Attaching.....	28-29	Remote Retrieve	
Fixing.....	30-31	Manual.....	40,129
Pinout.....	136	QuickPac.....	41,130
Printer/Hard Disk/8088..	11-13,15-16,27	Retrieve	
Video -		Applications.....	40-41,123-127, 129-130
SEE Video		Diskette order.....	124-125
Centronics printer -		Error message.....	127
SEE Printer,Parallel		DCL.COM	
COPY.....	20-21,46,131	DFD.SPR.....	66,135
Copy files		File requirements.....	66,135
COPY.....	20-21,46,131	Loading Drive C.....	40,66,70-71,81
DCA - Archive.....	7-8,40,113-122	Print Buffer.....	81-85
DCA - Retrieve.....	7-8,40-41, 123-127,129-130	Renaming drives.....	6-7,39-40, 70-71,100,103
DCA - Remote Retrieve...	40-41,129-130	DCLOADED.SYS.....	107
PIP.....	6,56-59,61, 67-69,76-77,112	DCN.COM.....	74-75
QuickPac.....	10,39,41, 100-107,130	DCQ.DAT	
WordStar.....	76-77,111	Customizing.....	41,139-140
CP/M		Creating.....	41,104-106, 139-140
DIR.....	50-54,66	Storing.....	104-106
ERA.....	60,97-98	Structure.....	139-140
Error messages.....	61	DCQAUT.COM	
FORMAT.....	45-46	Manual.....	41,139-140
MOVCPM.....	132	Renaming AUTOST.COM....	100,104-106, 139-140
PIP.....	56-59	DCQINS.COM	
prompt.....	2,45	Copying files.....	100,102
REN.....	55	Print Buffer.....	100,103
SYSGEN.....	23,32,47-48, 64,132	Renaming drives.....	100,103
System files.....	54,66	Running a program.....	100,103
System tracks.....	43-44	DCU.COM	
CP/M SYS DISK.....	19,42	Abbreviated commands....	96
DCA.COM		DCU E.....	97-98
Archive		Optimize.....	92-93
Applications.....	7-8,40-41,113, 122,129-130	Restart.....	95
Choosing files.....	114-115	Space.....	90-91

Index

<u>Item</u>	<u>Page</u>	<u>Item</u>	<u>Page</u>
DCU.COM (cont'd)		Loader & Archive.....	19-21
Wait.....	94	Monitors -	
Zap.....	95	SEE Video	
DC DEMO DISK.....	63-65	MOVCPM.....	132
DC USER DISK.....	19-23,32-34	Operating systems	
DFD.SPR.....	66,135	Buffer.....	43-44
DFDZCPR.SPR.....	141	CP/M.....	43-61
Directory Entries.....	134	Optimize -	
Displays -		SEE DCU.COM	
SEE Video		Packing Drive C -	
Drive C:.SYS.....	54,66,72-73,	SEE DCU.COM	
.....	97-98	PIP.....	6,56-59,67-69,
Dynamic Buffer -		76-77,112
SEE Print Buffer		Print Buffer	
Erasing files		Dynamic Print Buffer	
DCU E - Drive C.....	97-98	Manual installation...40,79,81,85,	
ERA - CP/M.....	60,97-98	128,135
Error Messages		Optimize -	
CP/M.....	61,97	SEE DCU.COM	
Drive C.....	83-84,86,127	QuickPac.....	100,103
PIP.....	61	Remove.....	81,135
EXT. VIDEO port - 01.....	11-12,15-18	Specs & TPA	134-135
EXT. VIDEO/BATTERY port...11-12,17-18		XDIR.....	85-87
Files		Fixed Print Buffer	
DIR.....	50-54,66	Manual Installation...40,79,81-84	
File name.....	50-54	QuickPac.....	100,103
File extension.....	50-54	Remove.....	81,135
Multiple - Buffer.....	9,95	Sizes.....	79-81
Buffer organization.....	90-93	Specs & TPA	134-135
XDIR.....	53-54,66	XDIR.....	82
Fixed Buffer -		Multiple files.....	9,95
SEE Print Buffer		Theory of operation....8-9,79-87	
Formatting.....	45-46,66	PRINTER/HARD DISK/8088....11-12,15-16,28	
Function keys.....	40-41,128	Printer, Parallel	
Hard disks -		Cable.....	11-12,28-31,
SEE TurboPac		136
IEEE-488 port - 01.....	11-12,15-16,	Installation.....	11-12,23,
.....	27-31	28-31,34-37
Installation		Power ON.....	28
Brown case - bumpers....14		SETUP.....	23,34
Cable clamp.....	15	Test.....	28-31,35-37
Displays -		Trouble-shooting.....	30-31,37-38,
SEE Video		136
Drive C unit.....	11-16	Printer, Serial	
Drive C signal cable....11-13,15-16		SETUP.....	23,34
Drive C video cable....11-13,15-16		Test.....	28,35-36
Parallel printer cable..28-31,136		Trouble-shooting.....	37-38
Video Shorting Plug.....	17-18	QuickPac	
LABEL -		Data files -	
SEE DCA.COM		SEE DCQ.DAT	

Index

<u>Item</u>	<u>Page</u>
QuickPac (cont'd)	
Installation -	
SEE DCQINS.COM	
Running -	
SEE DCQ.COM	
Starting -	
SEE DCQAUT.COM	
Quotation marks.....	49
RAM-disk	
Capacity.....	5-6,82,134-135
Files -	
SEE Copying files	
Loading.....	40,66,70-71,81
Renaming	
Initial installation..	6-7,39-40,
..	70-71,100,103
After installation....	74-75
Specs & Theory.....	5-9,62,66-75,
.....	133-135
Renaming files	
PIP.....	112
REN.....	55
WordStar.....	111
Renaming drives -	
SEE RAM-disk	
RESET button.....	6,72
Remote Retrieve -	
SEE DCA.COM	
Retrieve -	
SEE DCA.COM	
ROM - Rev. 1.2.....	22-23
ROM - Rev. 1.3-1.44.....	32-34
R/O (Read Only) files.....	61,72,97-98
RS-232 port -	
SEE Printer,Serial	
Saving files	
DCA.....	7-8,40-41,
.....	113-122
PIP.....	67-69,112
WordStar.....	111
Sectors.....	134
Serial port -	
SEE Printer,Serial	
SETUP.....	23,34,131-132
Space -	
SEE DCU.COM	
Specifications.....	133-135
Status messages -	
SEE DCU.COM	

<u>Item</u>	<u>Page</u>
SYSGEN.....	23,32,47-48,
.....	64,132
System Status.....	3-4
System Utilities	
COPY.....	20-21,46,131
SETUP.....	23,34,131-132
SYSGEN.....	23,32,47-48,
.....	64,132
Test Disk.....	42,45-48
TPA.....	135
TYPE messages -	
SEE DCU.COM	
TurboPac.....	10,134
Utility program -	
SEE DCU.COM	
Video	
Installation	
52 col. Ext. Monitor..	17-18
80 col. Ext. Monitor..	18
Osborne 52 col. Mon...	17-18
Osborne 80 col. Mon...	18
Internal display.....	17-18
Video adapters.....	17
80 col. upgrades.....	18
VIDEO port - Drive C.....	17-18
Video Shorting Plug.....	17-18
Wildcard	
DCA.....	114
DIR.....	52
ERA.....	60
PIP.....	57-58
REN.....	55
XDIR.....	54
WordStar	
Copying files.....	111
Print Patch.....	137-138
Running on Drive C	
Manually.....	76-77
QuickPac.....	102-107
ZCPR.....	141

Drive C 1690 65th Street Emeryville, California 94608 U.S.A.

Part Number 162869