

VT62 DECscope Technical Manual



digital

VT62 DECscope TECHNICAL MANUAL

1st Edition, March 1978

Copyright © 1978 by Digital Equipment Corporation

The material in this manual is for informational purposes and is subject to change without notice.

Digital Equipment Corporation assumes no responsibility for any errors which may appear in this manual.

Printed in U.S.A.

This document was set on DIGITAL's DECset-8000 computerized typesetting system.

The following are trademarks of Digital Equipment Corporation, Maynard, Massachusetts:

DEC	DECTape	PDP
DECCOMM	DECUS	RSTS
DECsystem-10	DIGITAL	TYPESET-8
DECSYSTEM-20	MASSBUS	TYPESET-11
		UNIBUS

CONTENTS

	Page
CHAPTER 1 INTRODUCTION	
1.1 GENERAL DESCRIPTION.....	1-1
1.1.1 VT62 System Description	1-1
1.2 FEATURES	1-2
1.2.1 Control	1-4
1.2.2 Formatted Screen	1-5
1.2.3 Input Fields.....	1-5
1.2.4 Automatic Field Checking.....	1-5
1.2.5 Error Messages.....	1-6
1.2.6 Program – Controlled Screen Layout.....	1-6
1.2.6.1 Display Area	1-6
1.2.6.2 Display Area Menu Selection	1-7
1.2.6.3 Dynamic Displays	1-7
1.2.6.4 Form Area	1-7
1.2.7 System/Terminal Configurations	1-8
1.2.8 Power-Up State	1-9
1.2.9 Data Transmission	1-9
1.2.10 Printer Option	1-9
1.3 SPECIFICATIONS.....	1-9
1.4 DOCUMENTATION ORDERING INFORMATION	1-9
CHAPTER 2 INSTALLATION	
2.1 SITE PLANNING.....	2-1
2.2 UNPACKING AND INSPECTION.....	2-1
2.3 INSTALLATION AND SETUP	2-1
2.4 ACCEPTANCE TEST PROCEDURES	2-10
2.4.1 Off-Line Tests.....	2-10
CHAPTER 3 OPERATION, PROGRAMMING, AND OPERATOR MAINTENANCE	
3.1 VT62 CONTROLS	3-1
3.1.1 Operator Controls	3-1
3.1.2 Keyboard.....	3-4
3.1.2.1 Alphabetic Keys	3-4
3.1.2.2 Numeric/Symbol Keys	3-4
3.1.2.3 Function Keys.....	3-7
3.1.2.4 Auxiliary Keyboard.....	3-9

CONTENTS

	Page
3.1.2.5	Auxiliary Keypad3-10
3.1.2.6	REPEAT Key.....3-10
3.1.3	Indicators.....3-10
3.2	OPERATING PROCEDURE3-11
3.2.1	OFF-LINE.....3-11
3.2.2	ON-LINE.....3-13
3.3	USER PROGRAMMING3-13
3.4	USER MAINTENANCE3-13
3.4.1	Irregularities in the Appearance of the Screen3-13
3.5	DIGITAL MAINTENANCE ARRANGEMENTS3-14
 CHAPTER 4 TECHNICAL DESCRIPTION	
4.1	GENERAL4-1
4.2	FUNCTIONAL DESCRIPTION4-1
4.2.1	Microprocessor Description4-3
4.2.2	Video Logic Description.....4-7
4.2.3	Communications Interface and Control Logic Description4-8
4.2.4	Keyboard Logic Description4-9
4.2.5	Printer Output Logic Description4-9
4.3	MODULE DESCRIPTION4-9
4.3.1	Processor/Video Board4-9
4.3.2	Input/Output Board.....4-9
4.3.3	Memory Module/PROM Module4-9
4.3.4	Keyboard.....4-9
4.4	MONITOR CIRCUITS4-10
4.4.1	CRT4-10
4.4.1.1	Beam Deflection4-10
4.4.1.2	Yoke Drivers4-11
4.4.1.3	Vertical Yoke4-11
4.4.1.4	Horizontal Yoke.....4-12
4.4.1.5	Video Circuits.....4-14
4.5	H7832 POWER SUPPLY4-14
4.6	COMMUNICATIONS OPTIONS4-14
4.6.1	20 mA Adapter Card (BN52B).....4-14
4.6.2	EIA Adapter Card (BN61B)4-14
 CHAPTER 5 SERVICING	
5.1	SERVICE PHILOSOPHY5-1
5.2	SUBSYSTEM LEVEL TROUBLESHOOTING5-1
5.2.1	Identifying the Faulty Subassembly5-1
5.2.2	Analyzing the Symptoms5-2

CONTENTS

	Page
5.2.3	Voltage Checks.....5-8
5.2.4	Monitor Waveforms.....5-12
5.2.5	Keyboard Troubleshooting Hints5-17
5.2.6	Communications Interface Troubleshooting.....5-17
5.3	SUBASSEMBLY REPLACEMENT5-17
5.3.1	Removing the Base Assembly5-20
5.3.2	Replacing the Memory Board.....5-24
5.3.3	Replacing the Processor/Video (P/V) Board.....5-26
5.3.4	Replacing the Monitor Board5-26
5.3.5	Replacing the I/O Board5-31
5.3.6	Replacing the Keyboard5-32
5.3.7	Removing the CRT Assembly.....5-33
5.3.8	Replacing the H7832 Power Supply5-38
5.3.9	Replacing the Switch Panel Board.....5-38
 CHAPTER 6 DISPLAY ADJUSTMENTS	
6.1	GENERAL6-1
6.2	HEIGHT ADJUSTMENT6-2
6.3	WIDTH ADJUSTMENT6-2
6.4	VERTICAL LINEARITY ADJUSTMENT6-2
6.5	FOCUS ADJUSTMENT6-2
6.6	DUAL INTENSITY ADJUSTMENT6-2
 APPENDIX A ENGINEERING SPECIFICATIONS	
A.1	VT62 ENGINEERING SPECIFICATIONSA-1
A.1.1	GeneralA-1
A.1.2	Hardware DesignA-1
A.1.2.1	Control ROM (CROM)A-1
A.1.2.2	Macro ROM (MROM).....A-1
A.1.2.3	Read/Write Memory.....A-1
A.1.2.4	Scratchpad MemoryA-1
A.1.2.5	Character Generation.....A-2
A.1.3	VT62 Overall Specifications.....A-2
A.1.4	20 mA Current Loop Specifications.....A-5
A.1.4.1	Baud Rates vs Distance for Integral 20 mA Loop.....A-6
A.1.4.2	20 mA Adapter Card with Cable (BN52B) Specifications.....A-6
A.1.5	EIA (With Control) Card Specifications (BN61B).....A-7
A.1.6	Reference DocumentationA-7

CONTENTS

	Page
APPENDIX B INSTALLATION PROCEDURES FOR COMMUNICATIONS OPTIONS	
B.1	REMOVING THE COMMUNICATIONS OPTIONB-1
B.2	INSTALLING THE COMMUNICATIONS OPTIONB-1
APPENDIX C ACCEPTANCE TEST PROCEDURES	
C.1	VT62 OFF-LINE ACCEPTANCE TESTS.....C-1
C.1.1	Setup ProcedureC-1
C.1.2	Self-Test Procedure.....C-3
C.1.3	Flashing Cursor CheckC-3
C.1.4	Display All Check.....C-3
C.1.5	CAPS LOCK CheckC-4
C.1.6	OFF-LINE Operating Mode Check.....C-4
C.1.7	Escape, Control, and Function Commands.....C-6
C.1.8	Escape, Control, and Function Command ChecksC-6
APPENDIX D VT62 OFF-LINE MODE CHARACTERISTICS	
D.1	GENERALD-1
D.1.1	Keyboard.....D-1
D.1.1.1	Alphabetic Keys.....D-1
D.1.1.2	Function Keys.....D-1
D.1.1.3	The DELETE CHAR (Control) KeyD-1
D.1.1.4	The SELECT (Escape) KeyD-2
D.1.1.5	Auxiliary Keypad.....D-2
D.1.1.6	The REPEAT KeyD-2
D.1.1.7	The COPY KeyD-2
D.2	OFF-LINE OPERATING CHARACTERISTICS.....D-5
D.2.1	Operating CharacteristicsD-8
D.3	DIAGNOSTIC OPERATING MODES.....D-8
D.3.1	Self-Test Diagnostic ModeD-8
D.3.2	Test Diagnostic Fault Locating ProcedureD-10
D.3.2.1	Installation of the VT62 Field Service Test CardD-10
D.3.2.2	Test Diagnostic Fault Locating ProcedureD-13
APPENDIX E VT62 TERMINAL INTERFACING	
E.1	TERMINAL INTERFACE SPECIFICATIONS.....E-1

FIGURES

Figure No.	Title	Page
1-1	VT62 Data Entry and Retrieval Terminal.....	1-1
1-2	VT62 Main Keyboard	1-3
1-3	VT62 Auxiliary Keypad and LED Display	1-4
1-4	Screen Layout	1-6
1-5	Menu Selection	1-7
1-6	VT62 Configurations.....	1-8
2-1	Site Considerations	2-2
2-2	Terminal, Rear View	2-3
2-3	Terminal, Bottom View, Base Front Screen Installed	2-4
2-4	Terminal, Bottom View (Partial), Base Front Screen Removed.....	2-5
2-5	Terminal, Bottom View (Partial), Base Removed.....	2-6
2-6	20 mA Communications Option Card Installation.....	2-7
2-7	EIA Conversion Board (BN61B) Installation.....	2-8
2-8	Limited Access Operator Control Switches.....	2-9
2-9	Terminal, Louver Plate Removal.....	2-11
3-1	Terminal, Rear View	3-2
3-2	Terminal, Bottom View	3-3
3-3	VT62 Main Keyboard	3-5
3-4	Auxiliary Keypad and LED Display.....	3-6
3-5	Terminal, Operator Control Switch Access Position	3-11
3-6	Terminal, Bottom View, Base Front Screen Installed	3-12
4-1	Functional Block Diagram	4-2
4-2	Cathode Ray Tube Diagram.....	4-10
4-3	Horizontal and Vertical Current Waveforms	4-11
4-4	Vertical Deflection Circuit.....	4-12
4-5	Horizontal Yoke Current	4-13
5-1	VT62 Terminal, Rear View.....	5-2
5-2	VT62 Terminal, Bottom View, Base Front Screen Installed.....	5-3
5-3	Removing the Switch Panel Board Connector.....	5-4
5-4	Limited Access Operator Control Switches.....	5-5
5-5	VT62 Keyboard	5-7
5-6	Voltage Test Points.....	5-10
5-7	Monitor Test Point 1	5-13
5-8	Monitor Test Point 2	5-13
5-9	Monitor Test Point 3	5-13
5-10	Monitor Test Point 4	5-14
5-11	Monitor Test Point 5	5-14
5-12	Monitor Test Point 6.....	5-15
5-13	Monitor Test Point 7	5-15

FIGURES (CONT)

Figure No.	Title	Page
5-14	Monitor Test Point 8	5-15
5-15	Monitor Test Point 9	5-16
5-16	Monitor Test Point 10	5-16
5-17	Monitor Test Point 11	5-16
5-18	Module Removal Sequence	5-18
5-19	Terminal Logic Board Removal.....	5-19
5-20	Terminal Servicing Position.....	5-20
5-21	Removing the Switch Panel Board Connector.....	5-21
5-22	Removing the 20 mA Communications Option Card	5-22
5-23	Removing the Base Assembly from the Shell.....	5-23
5-24	VT62 Terminal, Bottom View, Base and Louver Plate Removed	5-24
5-25	Memory Board Removal.....	5-25
5-26	VT62 Terminal, Bottom View, Base, Louver Plate, and Memory Board Removed	5-27
5-27	Processor/Video Board Removal	5-28
5-28	Louver Plate Removal.....	5-29
5-29	CRT Assembly	5-30
5-30	Monitor Board Removal	5-31
5-31	VT62 Terminal, Bottom View, Base and Louver Plate Removed	5-32
5-32	VT62 Terminal, Bottom View (Partial), Keyboard Module.....	5-33
5-33	CRT Assembly	5-34
5-34	CRT Assembly Removal Preparation	5-35
5-35	VT62 Terminal, Bottom View, CRT Assembly Removal.....	5-36
5-36	Discharging the CRT High-Voltage Anode.....	5-37
5-37	Louver Plate Removal.....	5-39
5-38	VT62 Terminal, Rear View (Upside Down), Louver Plate Removed	5-39
5-39	VT62 Terminal, Bottom View, Base Front Screen Installed.....	5-40
5-40	VT62 Terminal, Bottom View (Partial), Base Front Screen Removed.....	5-40
5-41	Switch Board Removal.....	5-41
6-1	Monitor Board Display Adjustments.....	6-1
A-1	VT62 Switch Setting Bit Configurations (Asynchronous Communication).....	A-5
B-1	Terminal Servicing Position	B-2
B-2	Switch Panel Board Connector Removal.....	B-3
B-3	20 mA Communications Option Card Removal.....	B-4
B-4	EIA Communications Option Card (BN61B) Removal.....	B-5
C-1	Operator Controls Access Position	C-1
C-2	VT62 Terminal, Bottom View, Base Front Screen Installed.....	C-2
C-3	VT62 Terminal, Rear View	C-4
C-4	VT62 Main Keyboard	C-5
D-1	VT62 Terminal, Rear View.....	D-5
D-2	Operator Access Position	D-6
D-3	VT62 Main Keyboard.....	D-7
D-4	LED Display.....	D-9
D-5	VT62 Terminal, Bottom View.....	D-11

FIGURES (CONT)

Figure No.	Title	Page
D-6	Switch Panel Board Connector Removal	D-12
D-7	20 mA Communications Option Card Removal.....	D-13
D-8	Base Assembly Removal.....	D-14
D-9	Location of J19 and J20.....	D-15
D-10	Test Diagnostic Card Installed	D-16
D-11	VT62 Terminal, Rear View.....	D-17
D-12	VT62 Terminal LED Octal Bit Pattern	D-18
E-1	VT62 Terminal Interface.....	E-1

TABLES

Table No.	Title	Page
2-1	VT62 Identification Tag Data.....	2-1
3-1	Operator Controls.....	3-1
3-2	Alphabetic Key Codes.....	3-4
3-3	Numeric/Symbol Key Codes.....	3-7
4-1	20 mA Interface Signals (BN52B)	4-15
4-2	EIA Interface Signals (BN61B).....	4-15
5-1	Voltage Test Points	5-9
D-1	Function Keys	D-1
D-2	Control Key Functions	D-2
D-3	Escape Key Functions.....	D-3
D-4	Special ESC Functions.....	D-4
D-5	Keypad Numeric Keys.....	D-4
D-6	Keypad Control Keys	D-4
D-7	Self-Test (CROM level).....	D-9
D-8	Self-Test Error LED Display	D-10

CHAPTER 1 INTRODUCTION

1.1 GENERAL DESCRIPTION

The VT62 video display terminal is a 24-line, 80-character display terminal that serves as an input/output (I/O) device to a host processor. The terminal transmits and receives data at speeds up to 9600 baud. It features a main keyboard which uses a standard typewriter layout. This keyboard supplies upper- and lowercase alphabetic characters as well as numeric, symbol, and control characters to a host. The video display of the terminal uses a 7×8 dot matrix to form the displayable characters.

1.1.1 VT62 System Description

The VT62 (Figure 1-1) is a buffered CRT terminal designed for data entry and retrieval applications. Like the VT61 and VT52, it is an upper- and lowercase ASCII video terminal whose display holds 24 lines of 80 characters.



8595-14-A0029

Figure 1-1 VT62 Data Entry and Retrieval Terminal

The VT62 is unique, however, because it is an application terminal for use in commercial markets. It is specifically designed for commercial data capture and retrieval applications, and can be operated by personnel not specially trained in using computers. The host computer defines the areas on the screen which the operator is allowed to enter, fill in, or select. The terminal provides most of the real-time detailed checking of operator responses, but the ability to extend some of the more complicated checking such as file searches to the host computer is provided also. Operator errors are signaled by an audible tone, an error light, and a short but descriptive message of what went wrong. Because the host computer loads the message array, it is not necessary to restrict the messages to the English language.

The VT62 uses a standard typewriter keyboard (Figure 1-2) except that the shift lock key is labeled CAPS LOCK and affects only the alphabetic keys. Operator-oriented features carried over from other VT50 models include an adjustable clicking sound which provides feedback as the operator strikes the keys and multiple key rollover to eliminate scrambling of characters, even if several keys are hit simultaneously. The VT62 also has a numeric/special function auxiliary keypad (Figure 1-3).

The ten numeric keys and the "." key on the 19-key auxiliary keypad serve an additional function as program function (PF) keys. The program function is indicated by a label on the front of the key cap and is obtained by striking the key while the SHIFT key is depressed.

The terminal can be placed in a special mode, selectable by the host software, in which the PF keys operate without the use of the shift key. In this case, the program foregoes the normal function of the numeric keypad.

The numeric keypad is functionally self-contained. If all replies in the form are numeric, the entire form can be entered and sent with one hand without moving from the keypad.

The VT62 provides eight light-emitting diodes (LEDs) located to the right of the keypad that indicate to the operator when a particular operating mode or condition of the terminal is in effect.

1.2 FEATURES

The VT62 contains many special features to enable foolproof operation by relatively unsophisticated users. It also provides reliable, cost-effective communication connections to DIGITAL computer systems for both local and distributed terminal networks.

Important features of the VT62 are:

1. Multipoint DDCMP block-oriented communication for complete data integrity and lower communication line costs
2. Half or full duplex and asynchronous or synchronous communication for application flexibility
3. Formatted split screen display with protected fields, menu selection, invisible password field, and reverse video
4. Local data checking and error notification for many operator errors
5. DIGITAL standard keyboard augmented by many special functions for operator convenience
6. High-level software support.

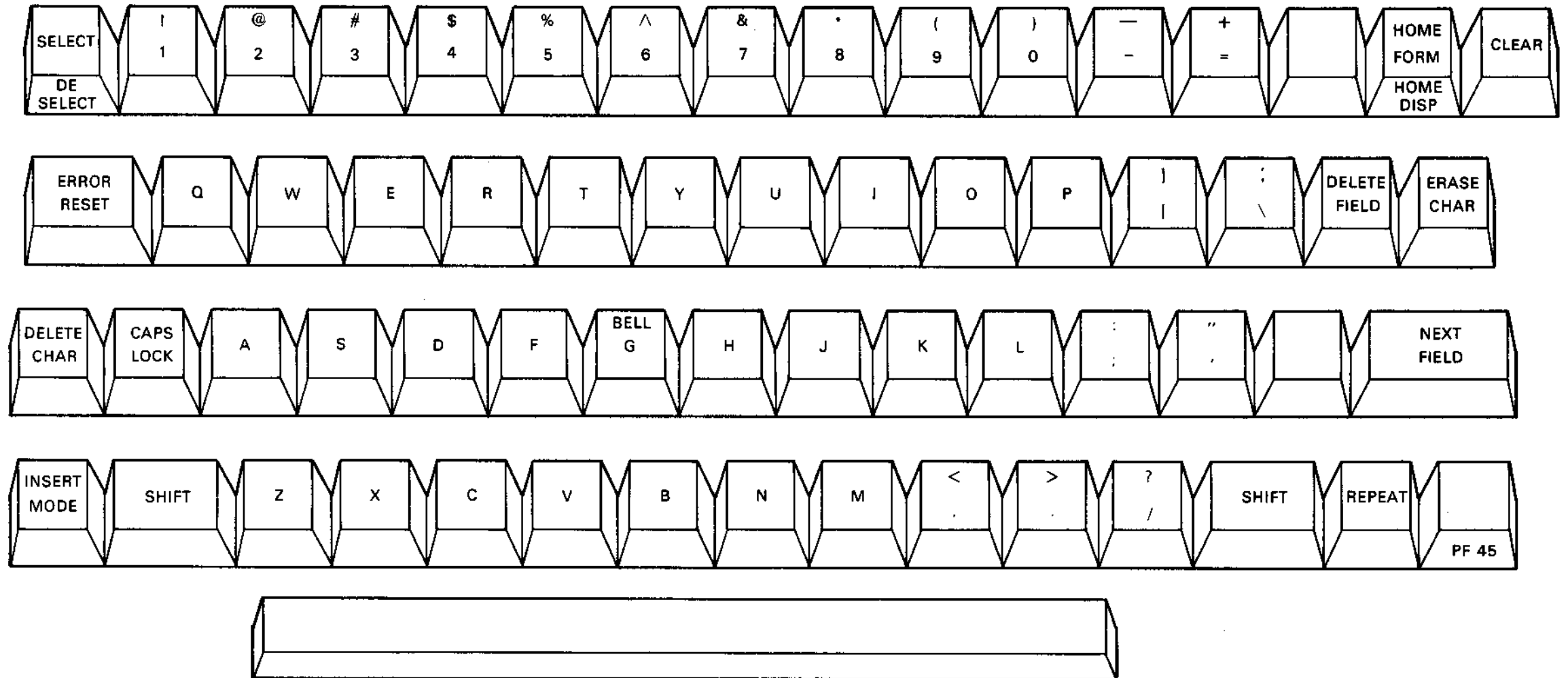

MA-0930

Figure 1-2 VT62 Main Keyboard

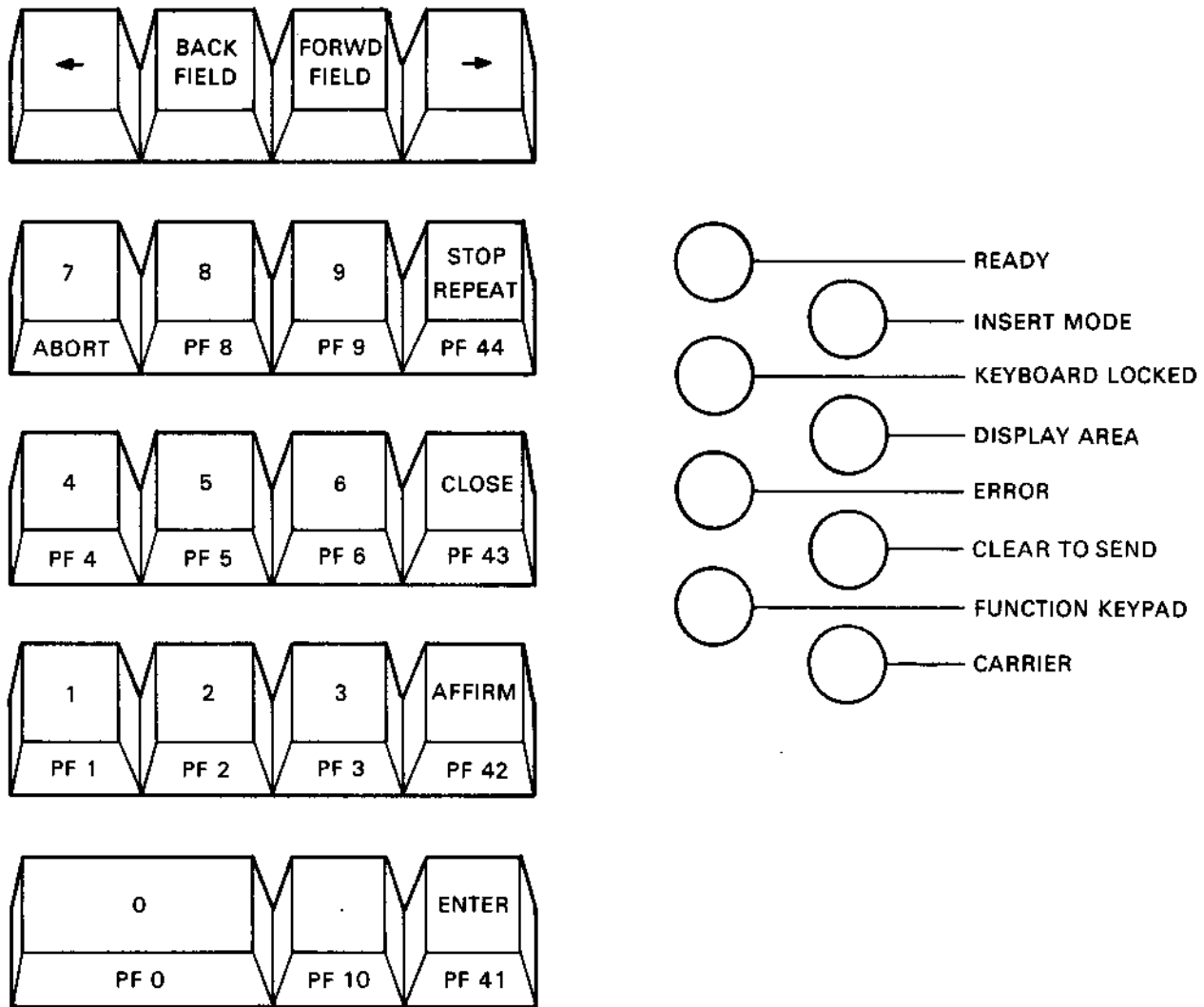

MA-0931

Figure 1-3 VT62 Auxiliary Keypad and LED Display

1.2.1 Control

Operation of the VT62 terminal is under control of the host computer; the terminal operator can only respond to activity initiated by the host. Many data input, editing, and correcting functions are available to the terminal operator under terminal control without host activity. Software in the host or front end computer controls the format of the terminal's display.

For foolproof protected operation by unsophisticated terminal users, the terminal has no direct access to the host machine's operating system. The analyst configuring a system with VT62 terminals can grant only those functions required for a specific application to the terminal user.

1.2.2 Formatted Screen

The visible VT62 screen is 24 lines of 80 upper- and lowercase characters each. The visible cursor alternates between normal and reverse video at approximately 2 Hz.

The VT62's display is "formatted," that is, it consists of protected fields:

1. Display Area – for operator prompting and information – provided in a rigid format described by the software which the operator is unable to alter from the keyboard, and
2. Form Area – for data entry – also established by the software with certain syntactic characteristics which are enforced by the terminal.

All text on the screen (except to some extent the input fields defined by the host software) is protected from the operator. A program in the host computer defines the fields for operator input by giving tables to the terminal.

1.2.3 Input Fields

The host software's field definitions instruct the system:

1. How to display the field,
2. What checks to perform on the data entered in the field (if any), and
3. In which format to return the entered data to the application program.

Field definitions supplied by the host software can specify the following attributes:

1. Field number
2. Screen position (line and column)
3. Length
4. Character type; for example:
 - a. Numeric
 - b. Numeric with decimal point (.) and sign (-) allowed
 - c. Alphanumeric with no special characters
 - d. Any displayable characters
 - e. Field must be entered
 - f. Field, if entered, must be full length
 - g. Right/left justified
 - h. Field may not be altered by operator

1.2.4 Automatic Field Checking

Character-type restrictions are enforced by the terminal as the operator is entering the content of the field. For example, the terminal does not allow an operator to enter any character other than 0 through 9 in a field defined as numeric. Other examples of how the terminal enforces field definitions are:

1. The "alteration" restriction is checked when the cursor attempts to enter the field: if the field may not be altered, the cursor moves to the next field (in the current direction, forward or back).
2. The "non-empty" and "full" restrictions are checked when the operator attempts to move the cursor out of the field: until certain conditions are met, the operator may not go on to the next field. For example, if a field must be entered, the operator must place a non-blank entry in the field before continuing.

1.2.5 Error Messages

When an operator error is detected by the terminal, one or two messages appropriate to the field type are displayed on the bottom line of the screen and the terminal rings the "bell." The error messages are removed from the error line (bottom line on the screen) when the operator completes that field correctly.

A table of error messages is maintained by the terminal in an off-line mode to guide the operator filling in the form. The error messages are loaded into the terminal by the host computer during the initial definition period. These error messages are maintained by the terminal in an off-line mode, that is, without intervention of the host computer during the transaction process.

The bottom line of the screen is reserved for error messages; if no messages are sent to the terminal for off-line cueing, the bottom line can be used by the program.

Error messages may be given under the following conditions:

1. Field length exceeded
2. Non-digit in numeric field
3. Illegal character in amount field
4. Special character in alpha field
5. Field entered less than full length
6. Required field not entered
7. Attempt to alter protected text.

1.2.6 Program - Controlled Screen Layout

The VT62 screen can be divided into two parts for the convenience of the operator and the programs. The top portion is the display area; the bottom is the form area (Figure 1-4). The dividing line between the two areas is conceptual only; there is no visible indication. The location of the division is under program control. A program can choose to devote from 0 to 24 lines of the screen to the display area, leaving the remainder of the screen for the form area.

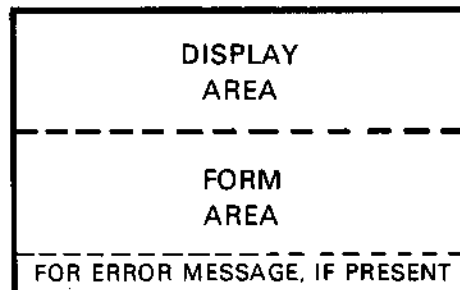

MA-0925

Figure 1-4 Screen Layout

1.2.6.1 Display Area - The display area is intended for two uses: to supply dynamic information to the operator; and to allow the operator to choose easily from structured menus. The display area can be cleared, filled, altered, or changed in size under program control. Operators may not alter its contents in any way, but they can move the visible cursor into the area to select an item from a menu displayed there.

1.2.7 System/Terminal Configurations

The VT62 can be connected to a system in multipoint and single-point configurations using a multiplexer (Figure 1-6). Local single-point connections can be accomplished without modems. In either case, the VT62 acts as a DDCMP multipoint tributary (multidrop slave, circumspect mode), transmitting only when polled by the host or front end computer. In multipoint configurations, therefore, the host computer has complete control over all terminals connected by multidrop lines – and many terminals can be serviced concurrently. In single-point configurations, the host computer has complete control over the terminal's demands on the system's resources.

All communication between the terminal and the computer is in blocks of data containing both commands and text.

The VT62 may be configured three ways:

1. EIA synchronous, up to 4800 baud – for use with a synchronous modem as a stand-alone multidrop terminal.
2. EIA asynchronous, up to 9600 baud – for direct radial (single-drop) connection to a host or concentrator, as a high-speed local terminal.
3. 20 mA asynchronous, up to 9600 baud – for direct radial (single-drop) connection to a host or concentrator, as a high-speed local terminal (with the optional 20 mA communications interface card).

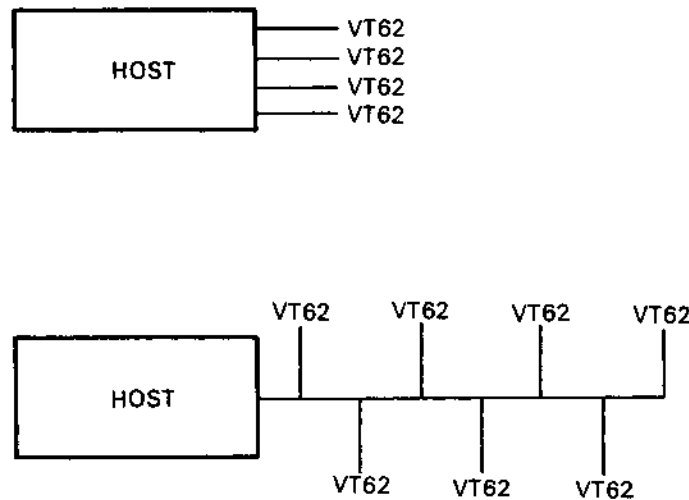

MA-0927

Figure 1-6 VT62 Configurations

1.2.8 Power-Up State

When powered up in the on-line mode, the terminal immediately enters Short Self-Test. At the end of the self-test (approximately 10 seconds), when polled, the terminal sends a DDCMP START or START ACKNOWLEDGE message to the host. The host software can then take action to set up the terminal for the operator. In case of temporary power loss, it is possible that the host may have to take special action to continue transactions that were in process.

To the operator the terminal screen is blank and the keyboard is locked.

1.2.9 Data Transmission

If the cursor is within the form area of the screen when the ENTER key is pressed, the contents of all fields entered by the user are sent to the host.

Transmission of data from the input fields can be in packed or unpacked format at the discretion of the software. In packed format, only fields entered or modified by the terminal operator are transmitted and these fields are null-compressed. In unpacked format, all characters of all fields are transmitted with no data compression and no field separators.

1.2.10 Printer Option

On command from the host, the terminal will send information to the printer interface. Three types of printing are possible:

1. Dump the display portion of the screen
2. Dump one specific line from the screen
3. Send text directly to the printer without altering the content of the screen.

No additional formatting is implied. The screen is not cleared or altered.

1.3 SPECIFICATIONS

Appendix A contains the VT62 engineering specifications. The *VT62 User's Guide* contains the VT62 functional specifications.

1.4 DOCUMENTATION ORDERING INFORMATION

The following VT62 hardware manuals are available from DIGITAL's Accessory and Supplies Group.

Title	Index No.
VT62 DECscope User's Guide	EK-VT62-UG-001
VT62 DECscope Maintenance Documentation	FB-VT62

All purchase orders and inquiries for hardware documentation should be forwarded to:

Digital Equipment Corporation
Accessory and Supplies Group (PO86)
Cotton Road
Nashua, New Hampshire 03060

CHAPTER 2 INSTALLATION

2.1 SITE PLANNING

The VT62 design will normally pose few constraints on selecting a place to install the terminal (Figure 2-1). In most cases, any environment suitable to the operator will be satisfactory for the terminal. Temperature and humidity extremes should be avoided. Appendix A of this manual is a summary of the guaranteed VT62 operating conditions.

2.2 UNPACKING AND INSPECTION

1. Unpack the terminal and place it on the surface where it will be operated.
2. Inspect the terminal for physical damage.
3. Ensure that site power meets the requirements of the terminal. The electrical requirements of the terminal and the communications interface supplied with the unit is provided by the identification tag located on the rear of the terminal (Figure 2-2). This tag also contains the serial number and the model number of the terminal. Use Table 2-1 to translate the identification tag data into usable information.

Table 2-1 VT62 Identification Tag Data

Communications Option	115 V, 60 Hz	230 V, 50 Hz
20 mA loop, Mate-N-Lok	VT62-AA	VT62-AB
EIA with control	VT62-AC	VT62-AD

All VT62 models come equipped with the parallel interface for the printer (LA180 or equivalent). However, the printer is supplied separately and is not specified by the model number of the VT62.

2.3 INSTALLATION AND SETUP

Perform the following steps to install the VT62:

CAUTION

Ensure that the terminal line cord is not connected to an electrical outlet and that the power (ON/OFF) switch is in the OFF position (Figure 2-2).

1. Place the unit upside down on a workbench or table (Figure 2-3).
2. Remove the upper cable clamp securing the option cable to the base assembly (two phillips head screws 8-32 × 0.38).

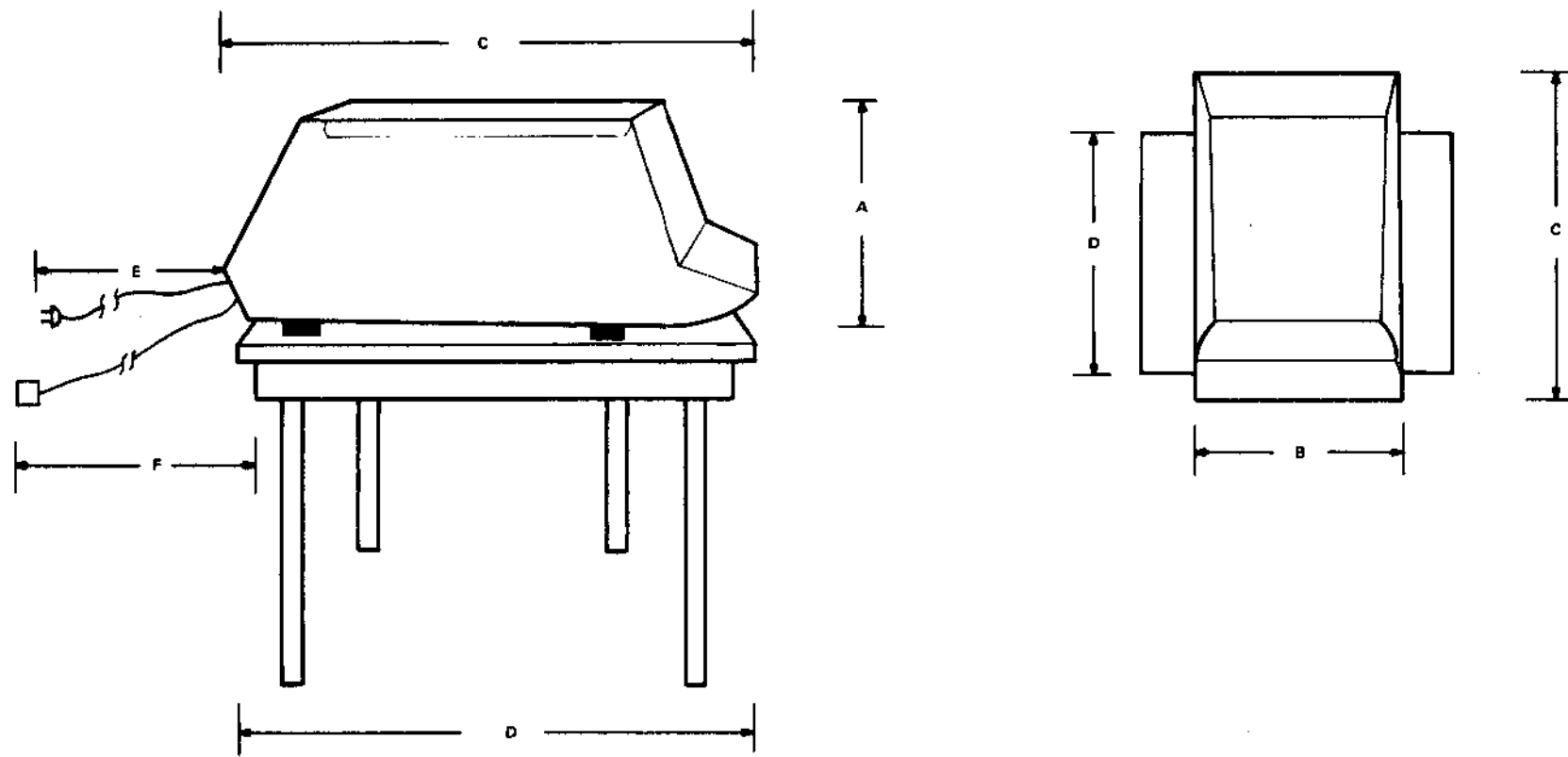

DIMENSIONS	MILLIMETERS	INCHES
A. Height	360	14.1
B. Width	530	20.9
C. Depth	690	27.2
D. Minimum Table Depth	450	17.2
E. AC Line Cord Length	2438	96.0
F. Interface Cable	*	*

*Total cable length (including the 7,620 meter (25 foot) cable supplied) must not exceed 304.8 meters (1000 feet).

CP.2819

Figure 2-1 Site Considerations

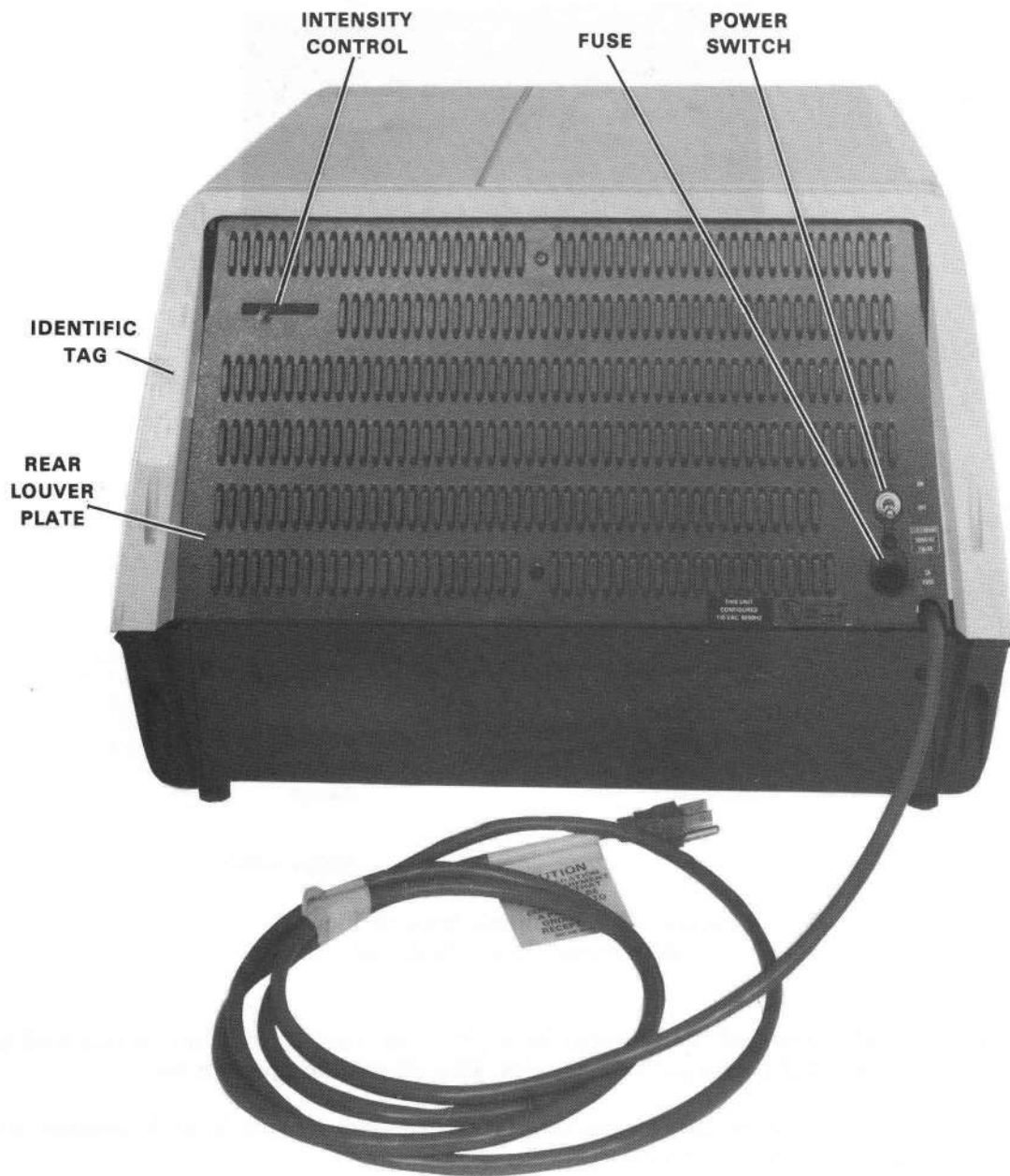

8595-5-A0005

Figure 2-2 Terminal, Rear View

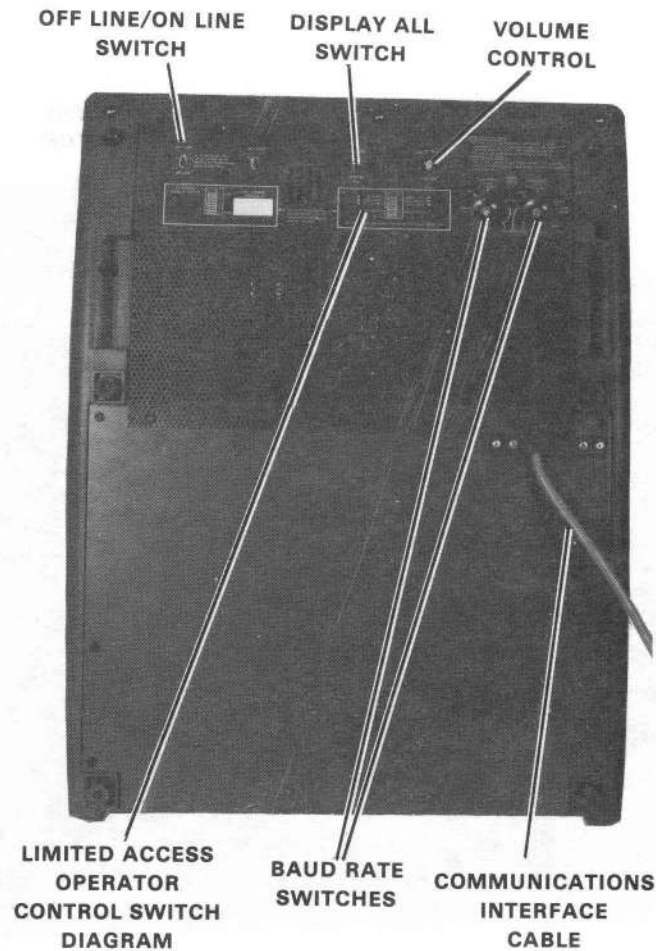

8595-9-A0003

Figure 2-3 Terminal, Bottom View,
Base Front Screen Installed

3. The forward portion of the terminal base (the base front screen) can be removed to gain access to part of the terminal's electronics. This allows the operator to:
 - a. Remove the communications interface card and replace it with another communications option (Appendix B).
 - b. Access the terminal address switch and/or the HALF/FULL DUPLEX, PARITY ON/OFF, PARITY EVEN/ODD, 7/8 DATA BIT, and 50/60 Hz switches located inside the unit.
 - c. Plug in the cable to the printer.

The base front screen is held down at the rear by five hex-head screws and at the front by a lip in the shell material. By unscrewing the hex-head screws, this section of the base can be lifted out. It is not necessary to remove the entire base.

Carefully remove this section of the base; the switches and speaker which are attached to the screen will still be connected to the internal electronics by a cable (Figure 2-4).

4. Remove the switch panel board connector P1 from J4 on the I/O board (Figure 2-4).
5. The 40-pin male Berg connector (visible at the right in Figure 2-4) is the connector for the general output register (printer). The cable from the LA180 or equivalent printer should be attached to this plug so that the lettering on the cable faces you and can be read.

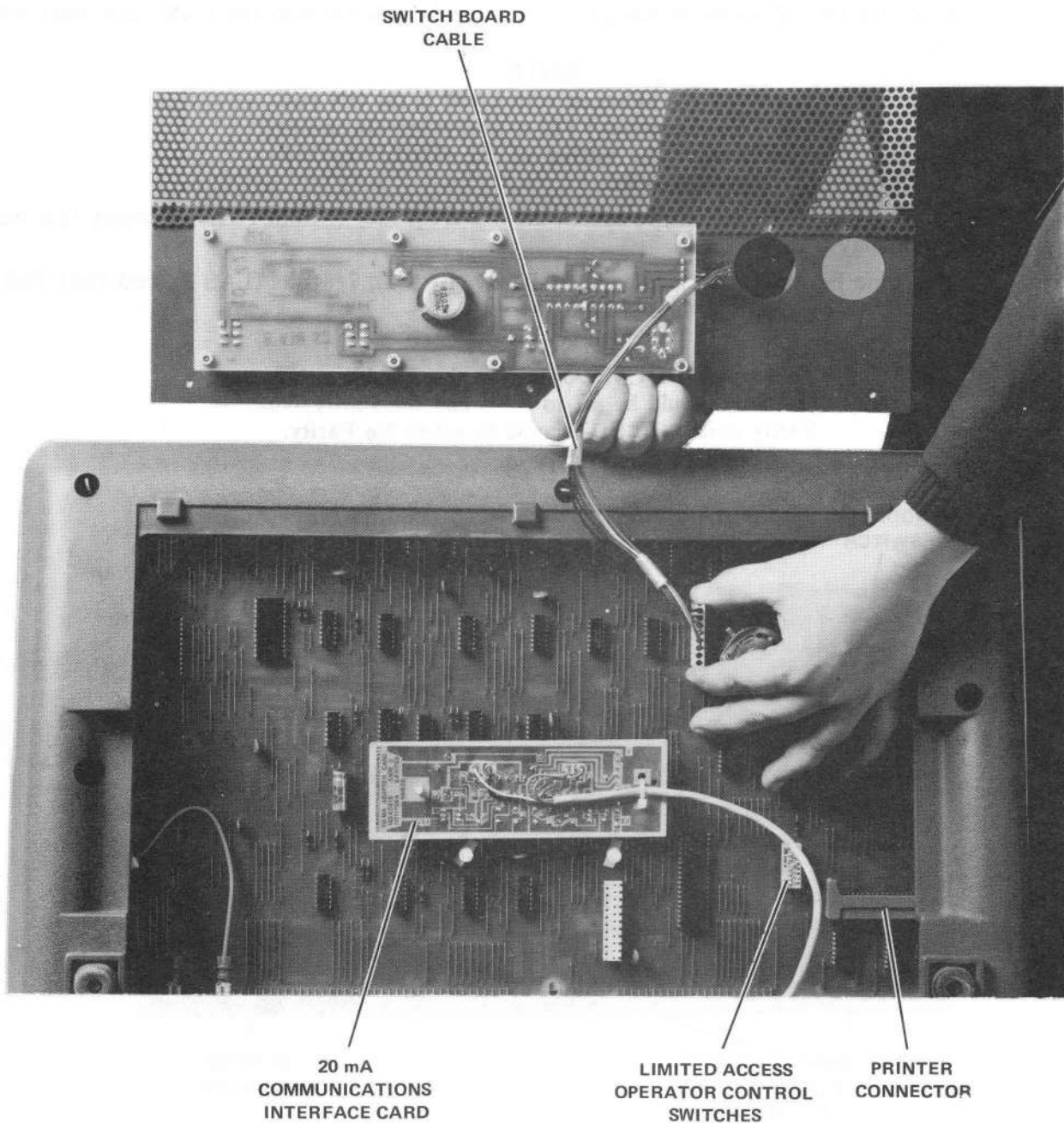

Figure 2-4 Terminal, Bottom View (Partial),
Base Front Screen Removed

8284-14-A0007

6. There are two 11-pin connector rows in the center of the printed circuit board (Figure 2-5). The communications interface card (20 mA or EIA) is plugged into one or both of these connectors depending on its size. A single-width card that has only one connector on its underside (i.e., the 20 mA card) will plug into the connector closest to the front of the unit (Figure 2-6). The BN61B EIA connector, which provides control as well as data signals, will use both rows of pins (Figures 2-5 and 2-7). Appendix B contains complete communications interface installation instructions.
7. The limited access operator control switches (Figure 2-8) are also found under the base screen. The switches are shown by a diagram mounted on the portion of the base screen that was removed (Figure 2-3).

Ensure that limited access switch 4 (LAS 4) is in the ON position and LAS 7 is in the OFF position.

NOTE

The VT62 can be set up with LAS7 in the ON position. This causes the VT62 to always remain on-line, regardless of the setting of the ON-LINE/OFF-LINE control switch.

Set LAS 8 (50/60 Hz switch) to match the line frequency (within 1 Hz) to ensure that the video display is easy to read.

At this time Parity (LAS 1), Even/Odd Parity (LAS 2), 7/8 Bits (LAS 3), and Half/Full Duplex (LAS 6) selections should be made.

NOTE

To support DDCMP operation the 7/8 bit switch (LAS 3) should be set to 8 bit and the Parity/No Parity switch (LAS 1) should be set to No Parity.

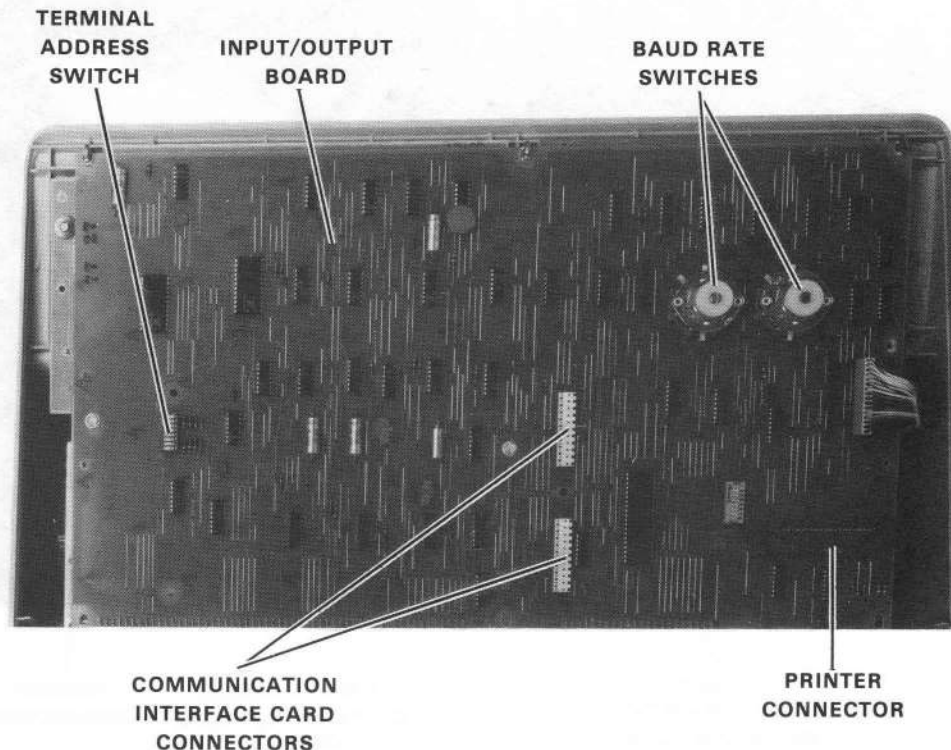
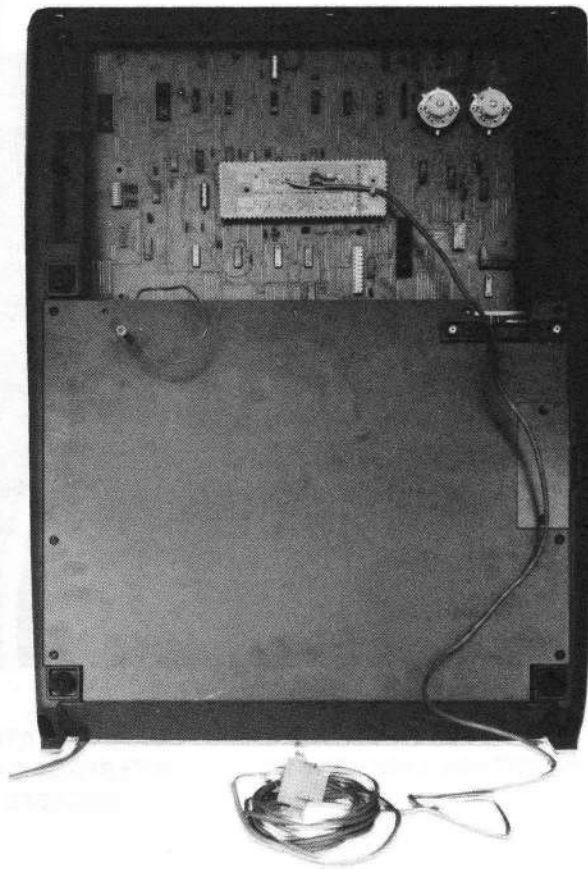
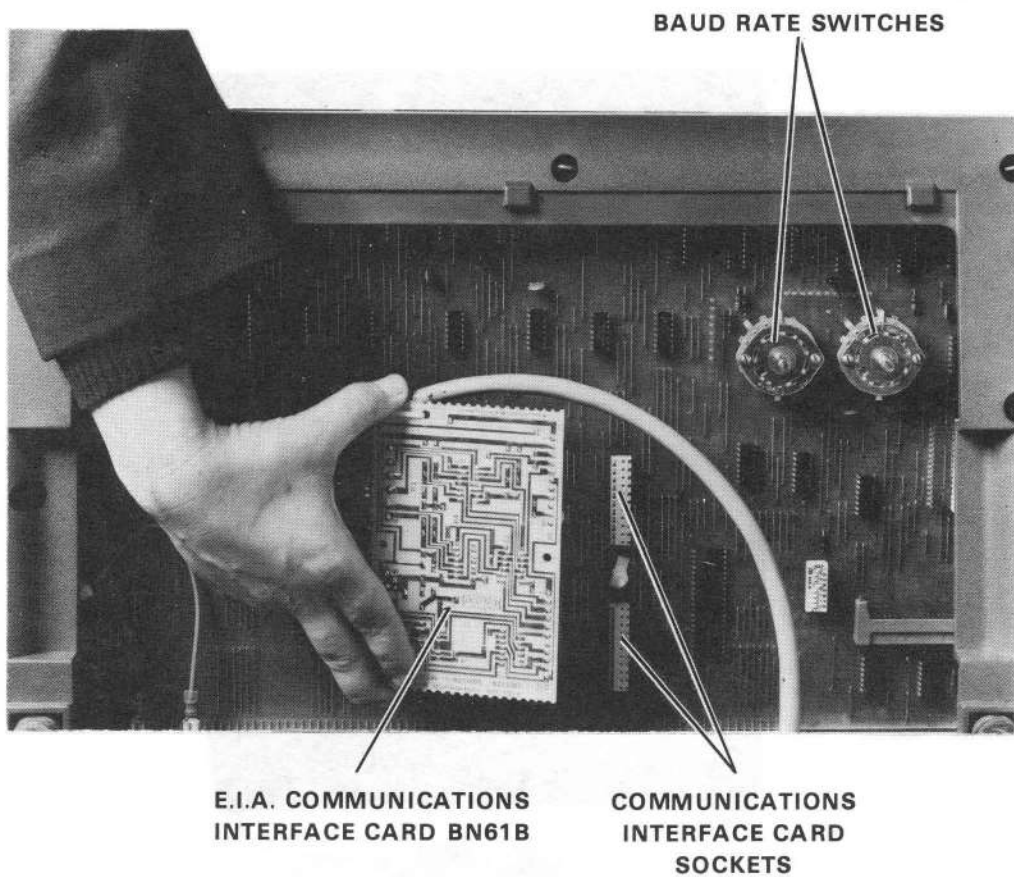

Figure 2-5 Terminal, Bottom View (Partial), Base Removed



8595-15-A0030

Figure 2-6 20 mA Communications Option Card Installation



8284-12-A0026

Figure 2-7 EIA Conversion Board (BN61B) Installation

LIMITED ACCESS
OPERATOR CONTROL SWITCHES

PRINTER
CONNECTOR

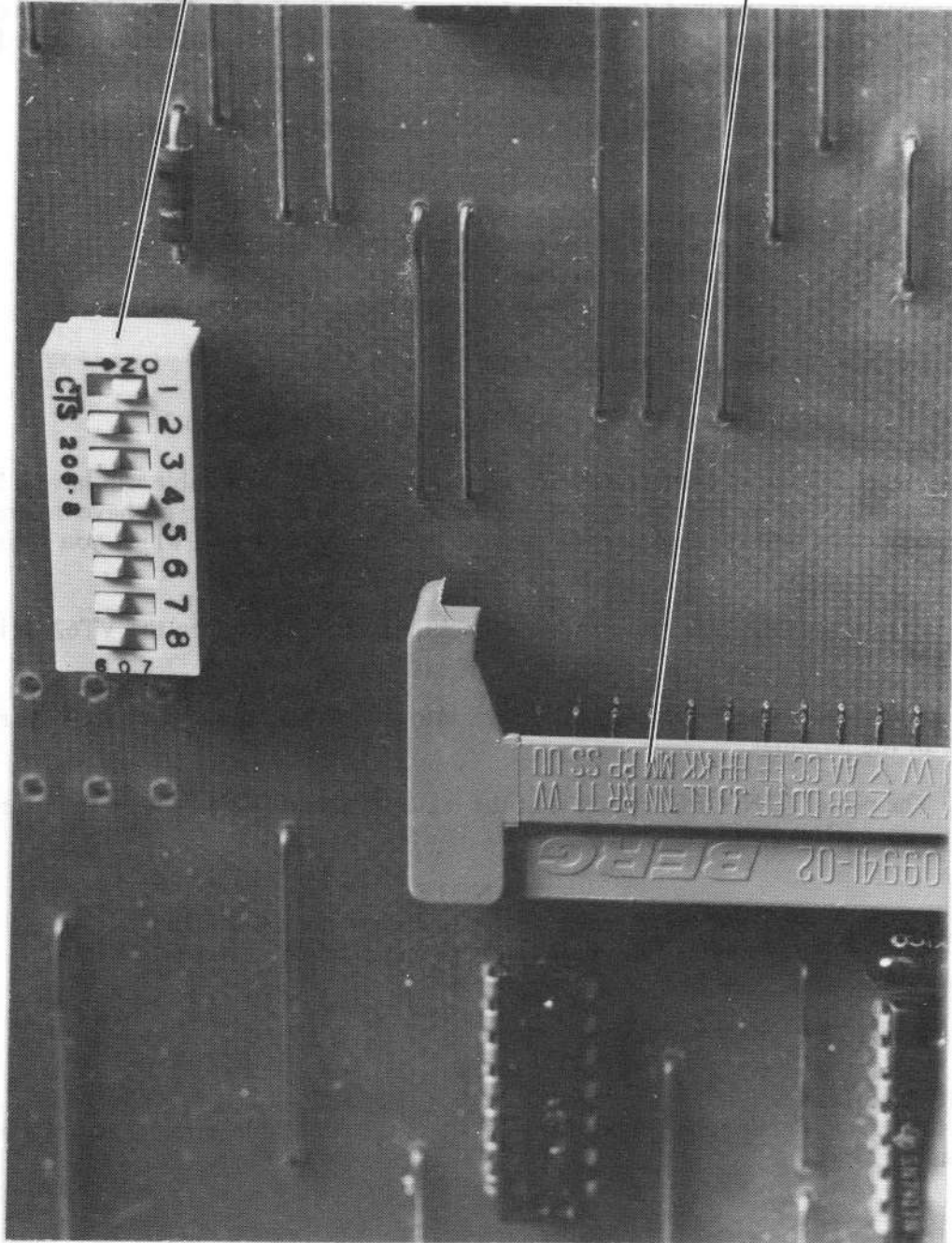

8284-25-A0031

Figure 2-8 Limited Access Operator Control Switches

8. If a terminal address is required, set the terminal address switch at this time (Figure 2-5).

There is an adjustment to adapt the VT62 to the higher voltage ranges (180-254 V). This switch is found on the power supply module (Figure 2-9) and is clearly marked 115 (90-127 V range) and 230 (180-254 V range). To gain access to the power supply, the rear louver plate must be removed. In addition to the steps covered so far, this will involve removing the screws in the rear louver plate with a 1/4 inch nut driver and removing the louver plate. Reverse these steps before applying power.

9. Replace the switch panel board connector P1 to J4 on the I/O board.

CAUTION

Ensure that P1 is replaced correctly on J4, with the black wire of the cable toward the front of the unit. P1 replaced incorrectly on J4 will damage the I/O board upon power-up necessitating its replacement.

10. Replace the base front screen by reversing step 3.
11. Secure the option cable to the base assembly by reversing step 2.
12. Figure 2-3 shows another cable coming from the unit. This cable will have a Mate-N-Lok connector or an EIA connector, depending on which option you have ordered. Plug this connector into the I/O part of the computer or modem with which you wish to communicate.
13. Ensure that the rear louver plate is back in place; then return the VT62 to its operating position.
14. Plug the 3-pronged line cord of the unit into an electrical outlet that meets the requirements of the terminal.
15. The power (ON/OFF) switch is at the rear of the unit (Figure 2-2). Make sure it is in the upper (ON) position.

NOTE

Run the interface cabling to the host according to the appropriate cable configuration diagram in Appendix E.

2.4 ACCEPTANCE TEST PROCEDURES

2.4.1 Off-Line Tests

Perform the tests in Paragraphs C.1.1 through C.1.8 of the applicable terminal acceptance procedures in Appendix C.

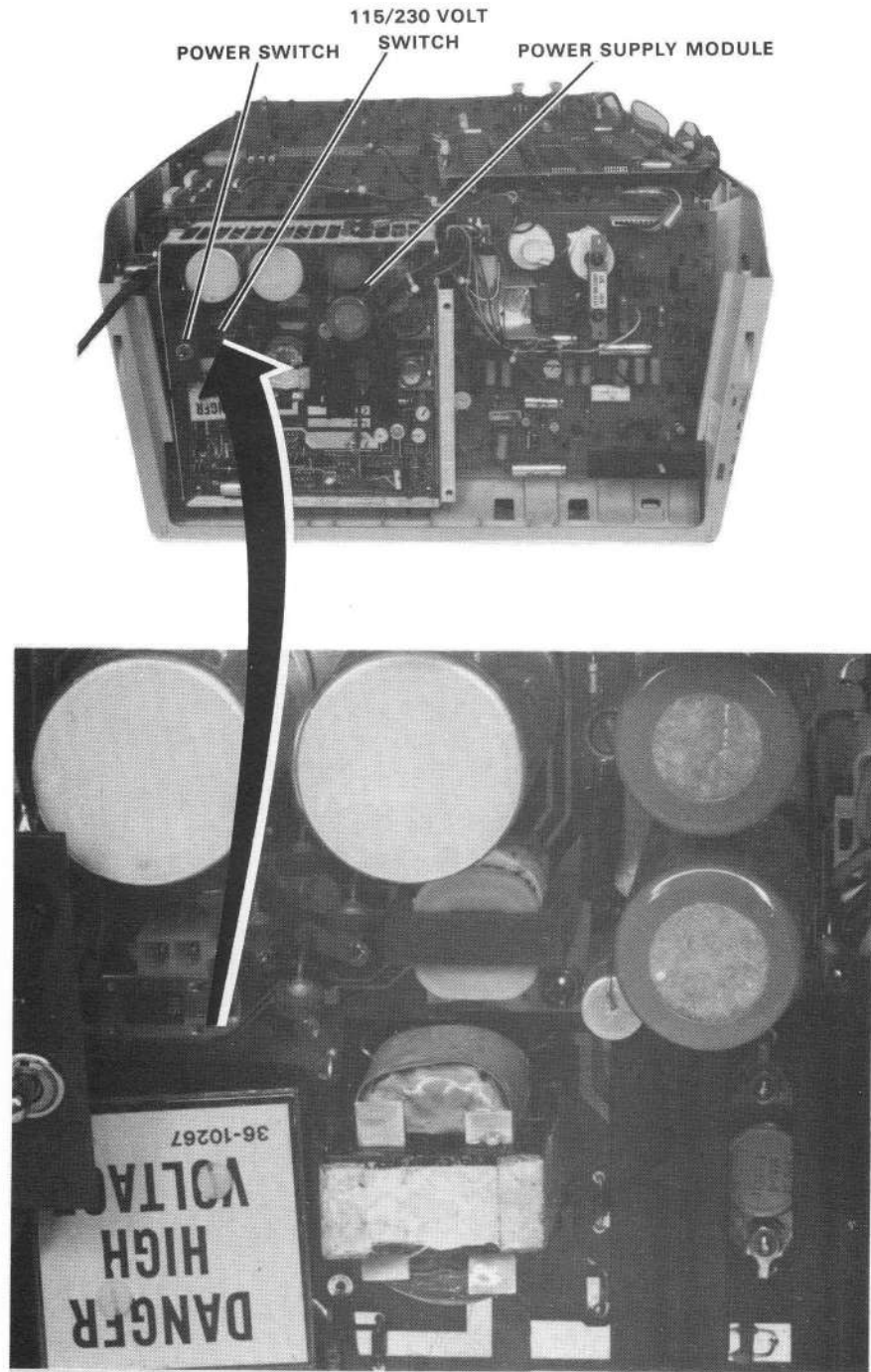

8595-11-A0020

Figure 2-9 Terminal, Louver Plate Removal

CHAPTER 3

OPERATION, PROGRAMMING, AND OPERATOR MAINTENANCE

3.1 VT62 CONTROLS

Two groups of controls are used in the VT62: operator controls and the keyboard. The operator controls set the operating parameters of the terminal such as intensity, baud rate, etc. The keyboard (and the auxiliary keypad) select the codes to be transmitted to the host computer. The eight LEDs located to the right of the auxiliary keypad indicate when a particular mode or condition is in effect.

3.1.1 Operator Controls

Operator controls and their functions are listed in Table 3-1; their physical location is shown in Figures 3-1 and 3-2.

Table 3-1 Operator Controls

Control	Location	Function
ON/OFF	Rear	Applies power to unit
Baud Rate switches	Front, bottom	Set the transmit and receive speeds of the terminal: 75 baud 110 baud 150 baud 300 baud 600 baud 1200 baud 1800 baud 2400 baud 4800 baud 9600 baud and select SYNC mode.
ON-LINE/OFF-LINE	Front, bottom	Selects remote or local operation
DISPLAY ALL switch	Front, bottom	Allows display of normally non-displayed characters
VOLUME	Front, bottom	Provides volume control of keyclick and bell alarm
INTENSITY	Rear	Sets video display intensity level

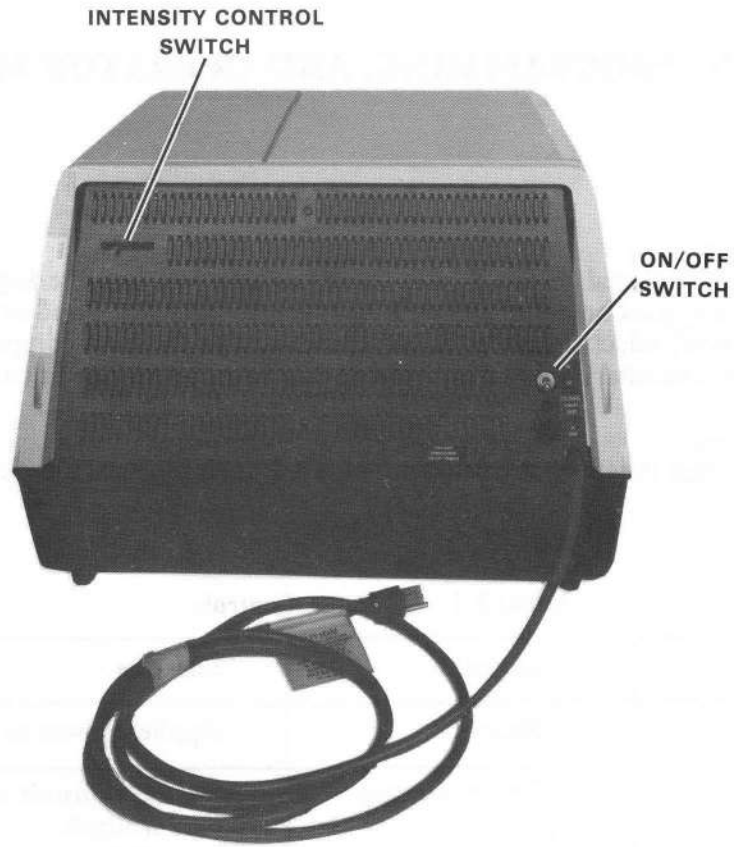

8595-5-A0004

Figure 3-1 Terminal, Rear View

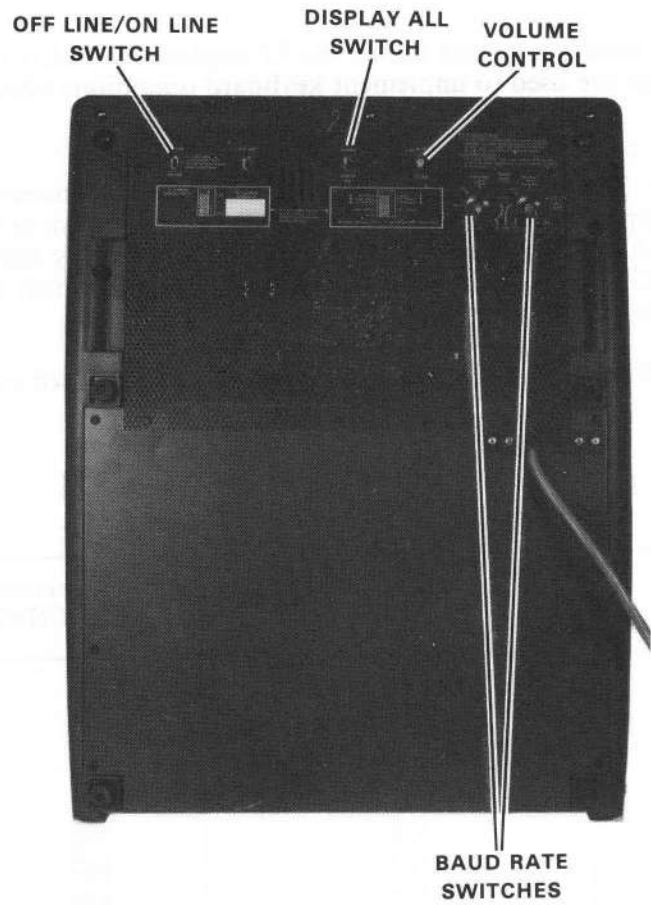

8595-9-A0018

Figure 3-2 Terminal, Bottom View

3.1.2 Keyboard

Input data to the host computer is entered via the main keyboard (Figure 3-3) or the auxiliary keypad (Figure 3-4). The keyboard transmits upper- and lowercase alphabetic code, numeric code, firmware-defined code, and user-defined code.

The keyboard has 52 keys used to generate any of the 95 displayable ASCII characters (040 through 176). The 10 remaining keys are used to implement keyboard operations which are useful in a form-filling application.

3.1.2.1 Alphabetic Keys – All alphabetic keys transmit in upper- and lowercase code. Uppercase is transmitted when a key is typed while either or both SHIFT keys are down, or while the CAPS LOCK key is down. (The CAPS LOCK key does not affect codes transmitted by keys other than the alphabetic keys. The CAPS LOCK key does have a maintenance function which will be discussed later.) Upper- and lowercase codes are listed in Table 3-2.

3.1.2.2 Numeric/Symbol Keys – Numeric and symbol key codes are listed in Table 3-3.

Table 3-2 Alphabetic Key Codes*

Key	Uppercase ASCII Code	Lowercase ASCII Code
A	101	141
B	102	142
C	103	143
D	104	144
E	105	145
F	106	146
G	107	147
H	110	150
I	111	151
J	112	152
K	113	153
L	114	154
M	115	155
N	116	156
O	117	157
P	120	160
Q	121	161
R	122	162
S	123	163
T	124	164
U	125	165
V	126	166
W	127	167
X	130	170
Y	131	171
Z	132	172

*All codes are expressed in octal.

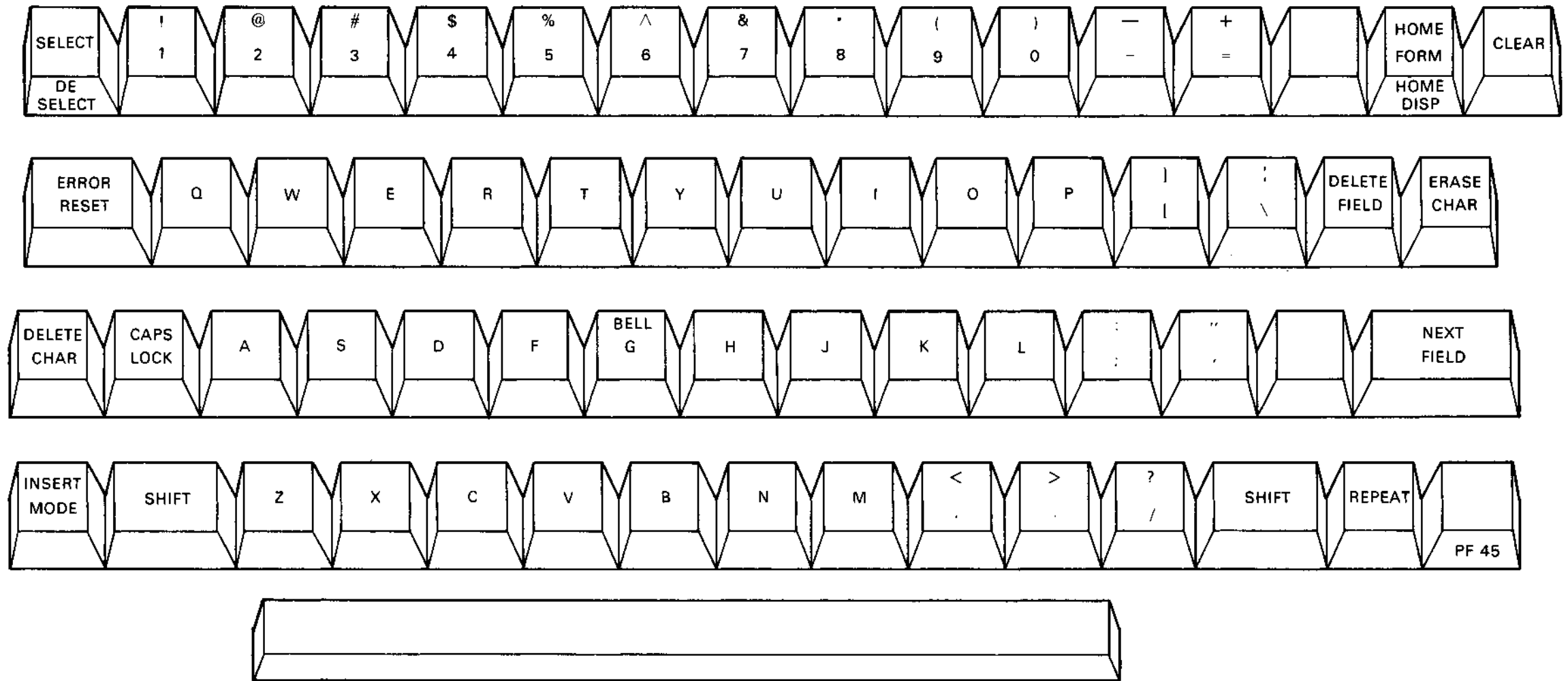

MA-0930

Figure 3-3 VT62 Main Keyboard

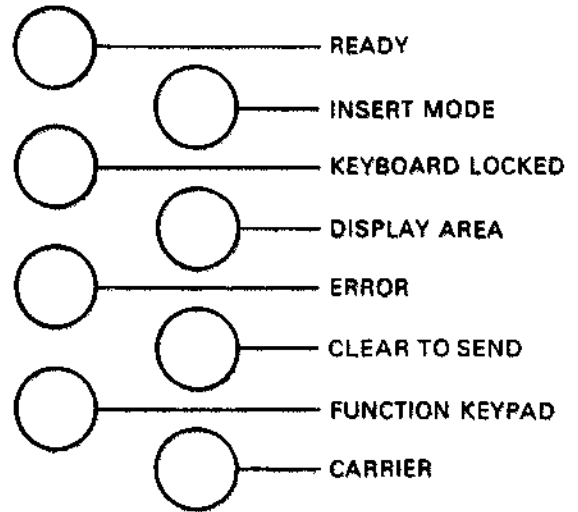
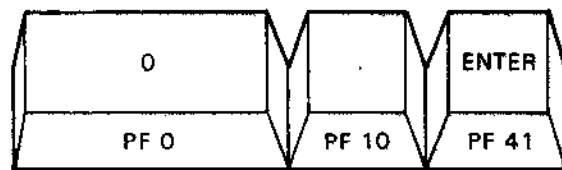
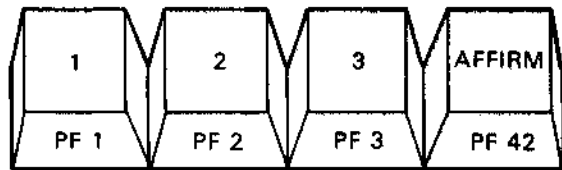
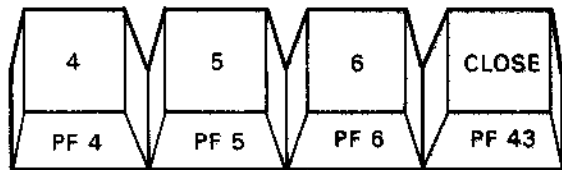
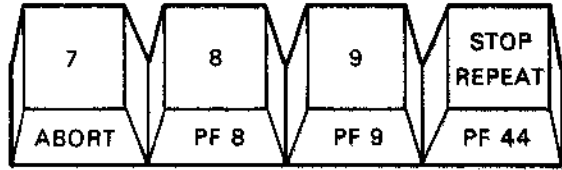
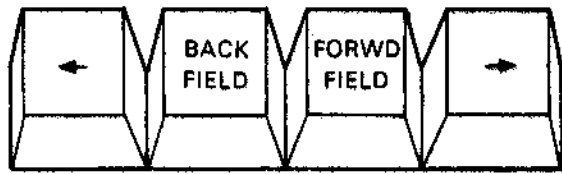

MA-0931

Figure 3-4 Auxiliary Keypad and LED Display

Table 3-3 Numeric/Symbol Key Codes

Key	Neither SHIFT Key Down	Either or Both SHIFT Keys Down
1	061	041 (!)
2	062	100 (@)
3	063	043 (#)
4	064	044 (\$)
5	065	045 (%)
6	066	136 (^)
7	067	046 (&)
8	070	052 (*)
9	071	050 (())
0	060	051 (())
-	055	137 (-)
=	075	053 (+)
[133	135 ([])
;	073	072 (:)
,	047	042 (,)
.	054	074 (<)
/	056	076 (>)
\	057	077 (3)
'	134	174 (')
μ	140	176 (=)
`	173	175 (˘)
		()

3.1.2.3 Function Keys - The 10 main keyboard function keys are used to implement keyboard operations in a form-filling applications. These keys and their associated functions are listed as follows:

HOME

(FORM)

This is the unshifted mode of the HOME key. If the form fields are enabled, HOME FORM moves the cursor to the first character of the first home field.

(DISP)

HOME DISP is the shift mode of the HOME key. If the menu fields are enabled, HOME DISP moves the cursor to the first character of the first home field.

ERASE CHAR

If the current field is left justified and the cursor is not at the beginning of the field, ERASE CHAR causes the cursor to backspace and then erase the character under the cursor. If the cursor is at the beginning of a field, ERASE CHAR leaves the cursor there and erases the character under the cursor. If the field is left justified, the text collapses from right to left; if the field is right justified, the text collapses from left to right. The positions left vacant by the justify operation will be filled with the clear character specified in the field definition for that field.

NEXT FIELD	If the current field is the last field, NEXT FIELD will clear to the end of the current field. If the current field is not the last field, NEXT FIELD will clear to the end of the current field and position the cursor to the first character of the next field. A field check will be done no matter what position the cursor is in when the key is depressed.
DELETE FIELD	When selected, DELETE FIELD will set the current field to all clear characters and move the cursor to the beginning of the current field.
CLEAR	(Display Area) When CLEAR is selected, all menu fields are restored to the normal video state. They are deselected and the cursor is positioned at the beginning of the first menu field. (Form Area) When CLEAR is selected, all form fields are cleared to their clear character values and the cursor is positioned at the beginning of the first form field.
PF45	(Blank Key) PF45 is a user-programmable function key. The <i>VT62 User's Guide</i> contains information concerning user programming.
DELETE CHAR	When selected, DELETE CHAR deletes the character under the cursor. If the field is left justified, the text will collapse from right to left; if the field is right justified, the text will collapse from left to right.
SELECT/DESELECT	This key is only enabled when the terminal is in menu mode and the cursor is in the display area. Unshifted a menu item is selected; shifting will deselect a menu item. Selected menu items are displayed in reverse video; deselected menu items are displayed in normal video.
INSERT MODE	Unshifted enables insert mode; shifted disables insert mode. If a field is left justified in the insert mode, each character typed into the field is entered under the cursor and all characters at or to the right of the cursor are shifted one position to the right. If the field is right justified, each character typed is entered under the cursor and all characters at or to the left of the cursor are shifted one position to the left. (Boundary Condition) When a field is filled (no clear characters on the left for right justified field or on the right for left justified field) additional characters typed will not be entered into field and the bell will ring.
ERROR RESET	If an error occurs, a message is printed on the bottom line, the bell rings, the Error LED is lit, and the terminal enters error mode. Until the operator presses ERROR RESET, thereby acknowledging the error, all keystrokes simply ring the bell. Errors occur if field validation fails or if the host computer selects an error message to be printed.

3.1.2.4 Auxiliary Keyboard – The 19-key auxiliary keypad (Figure 3-3) is provided for user applications. The numeric keypad is functionally self-contained. If all replies in the form are numeric, the entire form can be entered and sent with one hand without moving from the pad. Most keys on the numeric pad serve two functions: the first is indicated by the label on the top of the key cap; the second is indicated by a label on the front of the key cap. This second function is obtained by striking the desired key while the SHIFT key is pressed.

The terminal can be placed in a special mode, selectable by the host software, in which the PF keys operate in single keystrokes without the SHIFT key. In this case, the program foregoes the normal function of the numeric keypad.

These keys and their associated functions are listed as follows.

Cursor Right	<p>If cursor is at the rightmost position of a field, a no-operation exists. Move the cursor right one position.</p> <p>If auto-tab is enabled and pressing this key causes the cursor to be moved to the next field, field checking will be done on the field exited.</p> <p>This key is only enabled when the terminal is in menu mode and the cursor is in the display area. Shifted deselects a menu item; unshifted selects a menu item. Selected menu items are displayed in reverse video; deselected menu items are displayed in normal video.</p>
Cursor Left	<p>If cursor is at the leftmost position of a field, a no-operation exists. Move the cursor left one position.</p>
FORWD FIELD	<p>If current field is last field, move physical cursor to last position in field and logical cursor past field so that no data entry is allowed if a key is pressed; or move cursor to first character position of next field without changing anything in the rest of the current field. Field check will be done no matter what position the cursor is in when the key is pressed.</p>
BACK FIELD	<p>If current field is first field, move cursor to beginning of current field; or if cursor at beginning of current field move cursor to beginning of previous field; or move cursor to beginning of current field.</p>
Enter	User programmable*
Affirm-PF42	User programmable*
Close-PF43	User programmable*
Stop Repeat-PF44	User programmable*
0—9 and .	<p>If the keypad is in numeric mode, pressing unshifted 0—9 or . results in 0—9 or . - pressing shifted 0—9 or . results in PF0—PF6 and abort and PF8—PF10. If the keypad is in function mode, pressing 0—9 or . results in PF0—PF6 and abort and PF8—PF10, independent of the shift key.</p>

3.1.2.5 Auxiliary Keypad – The 19-key auxiliary keypad (Figure 3-4) is provided for user applications. The numeric keypad is functionally self-contained. If all replies in the form are numeric, the entire form can be entered and sent with one hand without moving from the pad. Most keys on the numeric pad serve two functions: the first is indicated by the label on the top of the key cap; the second is indicated by a label on the front of the key cap. This second function is obtained by striking the desired key while the SHIFT key is pressed.

3.1.2.6 REPEAT Key – The REPEAT key (main keyboard) is used in conjunction with other keys; it does not transmit a code. Any key that transmits a code to the host will transmit that code repeatedly if pressed while the REPEAT key is down. Keys that transmit more than one code will transmit their sequence repeatedly if pressed while the REPEAT key is down.

The following keys repeat if held down (without use of the REPEAT key):

- VT62 main keyboard – NEXT FIELD, ERASE CHAR, and DELETE CHAR.
- VT62 auxiliary keyboard – Cursor left, Cursor right, FORWD FIELD, and BACK FIELD

All keys for displayable characters can be forced to repeat by using REPEAT on the main keyboard.

3.1.3 Indicators

The LED display to the right of the keypad is labeled as follows:

Indicator	Function
READY	The DDCMP startup sequence has been successfully received.
KEYBOARD LOCKED	The operator may not type in data or select menu items.
FUNCTION KEYPAD	The keypad is in function (as opposed to numeric) mode.
INSERT MODE	The terminal is in insert mode.
DISPLAY AREA	The cursor is in the display area.
CLEAR TO SEND	A communication line has been established between the terminal and the host computer; the terminal can now send data.
CARRIER	A communication line is established between the terminal and the host computer.
KEYING ERROR	The terminal is in error.

The layout of the LED display is:

```

0-----READY
 0-----INSERT MODE
0-----KEYBOARD LOCKED
 0-----DISPLAY AREA
0-----KEYING ERROR
 0-----CLEAR TO SEND
0-----FUNCTION KEYPAD
 0-----CARRIER

```

3.2 OPERATING PROCEDURE

3.2.1 OFF-LINE

1. Ensure that the VT62 terminal line cord is not connected to an electrical outlet and the power (ON/OFF) switch is in the OFF position.
2. Make adequate room on the work surface and tip the terminal back until it is stable. This must be done to gain access to the switches on the underside of the unit (Figure 3-5).
3. Set the ON-LINE/OFF-LINE switch to the OFF-LINE position (Figure 3-6).
4. Return the VT62 to its proper operating position.
5. Plug the 3-prong line cord into an electrical outlet that meets the requirements of the terminal.

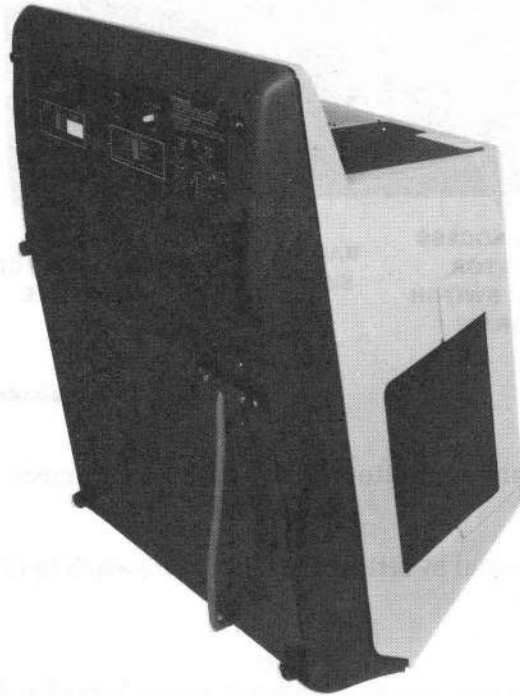

8595-10-A0028

Figure 3-5 Terminal, Operator Control Switch Access Position



8595-9-A0003

Figure 3-6 Terminal, Bottom View, Base Front Screen Installed

6. Apply power to the terminal by setting the ON/OFF switch to ON. This switch is located on the rear of the terminal.

NOTE

The terminal enters a self-test mode immediately upon power-up. If the terminal CAPS LOCK key is not in the pressed position, the terminal enters long self-test mode. The VT62 will remain in this mode until the CAPS LOCK key is pressed. When the CAPS LOCK key is pressed, the terminal enters short self-test mode and executes the Short Self-Test one time (approximately 10 seconds). At the end of the Short Self-Test, the terminal exits the self-test mode, the cursor goes to the HOME position (top-left corner of the display), and the keyboard is enabled.

7. Use the brightness control located on the rear of the terminal to adjust the brightness of the cursor. For the most comfortable viewing, set the brightness to the lowest possible level while still maintaining good character definition. High screen intensity causes characters to become fuzzy and prolonged viewing of the bright display is very tiresome.

3.2.2 ON-LINE

CAUTION

**Do not attempt to switch the unit ON-LINE now.
Damage to the host operating system could result.
Please comply with the following procedure:**

1. Remove power from the terminal by switching the power (ON/OFF) switch to OFF.
2. Tip the unit up and set the BAUD RATE switches to the desired frequency. Transmission speed must be set to the same frequency as the host's receiving speed; receiving speed must be set to the same frequency as the host's transmission speed.
3. Set the ON-LINE/OFF-LINE switch to ON-LINE.
4. Set the ON/OFF switch to ON to restore power to the terminal. When the Short Self-Test has terminated, the terminal can communicate with the host.

3.3 USER PROGRAMMING

The *VT62 User's Guide* explains the concepts necessary to understand the VT62 and describes in detail the effects of all commands to which the terminal responds.

3.4 USER MAINTENANCE

The keyboard circuit contains the only moving parts of the terminal and requires no preventive maintenance by the owner. The terminal may be cleaned with soap and water or any mild detergent. Although the terminal's shell provides superior resistance to damage from solvents, cleaners with solvents should not be used.

The unit packaging is not meant to be weatherproof: there are several openings in the case through which liquids, coins, paper clips, and other objects can fall. Such objects will disturb the electronic operation of the terminal if they come in contact with the circuitry. Avoid putting drinks and metal objects on top of the terminal or using excessive water to clean the terminal. The keyboard is an area where the electronics are particularly close to the exterior. Rubbing the keys with a dry or barely moist cloth should suffice to clean them. Do not remove the keycaps to clean them more thoroughly; damage may result to the switch contacts if they are replaced incorrectly.

3.4.1 Irregularities in the Appearance of the Screen

At some time in its life, the picture tube may appear to darken at each character position. This is a normal phenomenon; it does not affect the life expectancy of the tube and will not interfere with the display of characters when the unit is in operation. This is because the terminal lights up the screen only at the character positions, breaking in the phosphor at those positions on the screen.

Not all units contain the same type of picture tube. For this reason, the color of the screen may not be the same from unit to unit.

If, for these or other reasons, the appearance of the screen is not satisfactory, colored filters may be attached to the screen. A special nib was designed at the base of the screen in order to hold such filters in place.

3.5 DIGITAL MAINTENANCE ARRANGEMENTS

There are three ways that an owner can arrange for VT62 service:

1. **On-Site Contract** – This is the traditional priority service contract, available with various coverage hours.
2. **On-Site, Per-Call Service** – In this arrangement, DIGITAL charges for time and materials actually used.
3. **On-Site User Maintenance** – Module swapping kits are available. Failed modules are returned to the DIGITAL depot for repair in the mailers in which the swapping kits are mailed.

In some geographical areas, additional options are available; contact your local DIGITAL Field Service Office for information.

CHAPTER 4

TECHNICAL DESCRIPTION

4.1 GENERAL

This chapter provides a description of the major functions performed by the VT62 Video Display Terminal. It includes a functional description of the terminal microprocessor and the other major subassemblies located within the terminal.

A block diagram applicable to the VT62 is shown in Figure 4-1 and should help the reader understand the descriptions presented here.

4.2 FUNCTIONAL DESCRIPTION

The VT62 terminal is in some ways similar to the VT50 family of video terminals, but contains many new features. This terminal uses communication protocol, can handle an LA180 or equivalent printer, and generally allows an operator without prior computer experience to use the terminal. Operation of the VT62 is under control of the host computer, not the terminal operator. However, many data input, editing, and correcting functions are at the disposal of the terminal operator. Software in the host or front end computer controls the format of the display. For foolproof, protected operation by inexperienced terminal users, the terminal has no direct access to the operating system of the host machine: the analyst configuring a system with VT62 terminals can grant to the terminal user only those features needed to get the job done. The host computer defines the areas on the video display screen which the operator is allowed to enter, fill in, or select. The terminal provides most of the real-time detailed checking of operator responses, but the ability to extend some of the more complicated checking, such as file searches to the host computer is provided also. Operator errors are signaled by an audible tone, an error light, and a short but descriptive message of any errors. Because the host computer loads the message array, it is not necessary to restrict the error messages to the English language.

Three major functions are performed by the VT62:

1. As an input terminal, it processes keyboard data and transmits this data to the host processor.
2. As an output terminal, displayable characters received from the host are stored in the terminal memory and displayed on its screen. In addition to displayable characters, control characters are received by the terminal and are interpreted as commands.
3. As a video terminal, the VT62 displays the contents of its screen memory on the CRT display, refreshing this display at the line frequency rate.

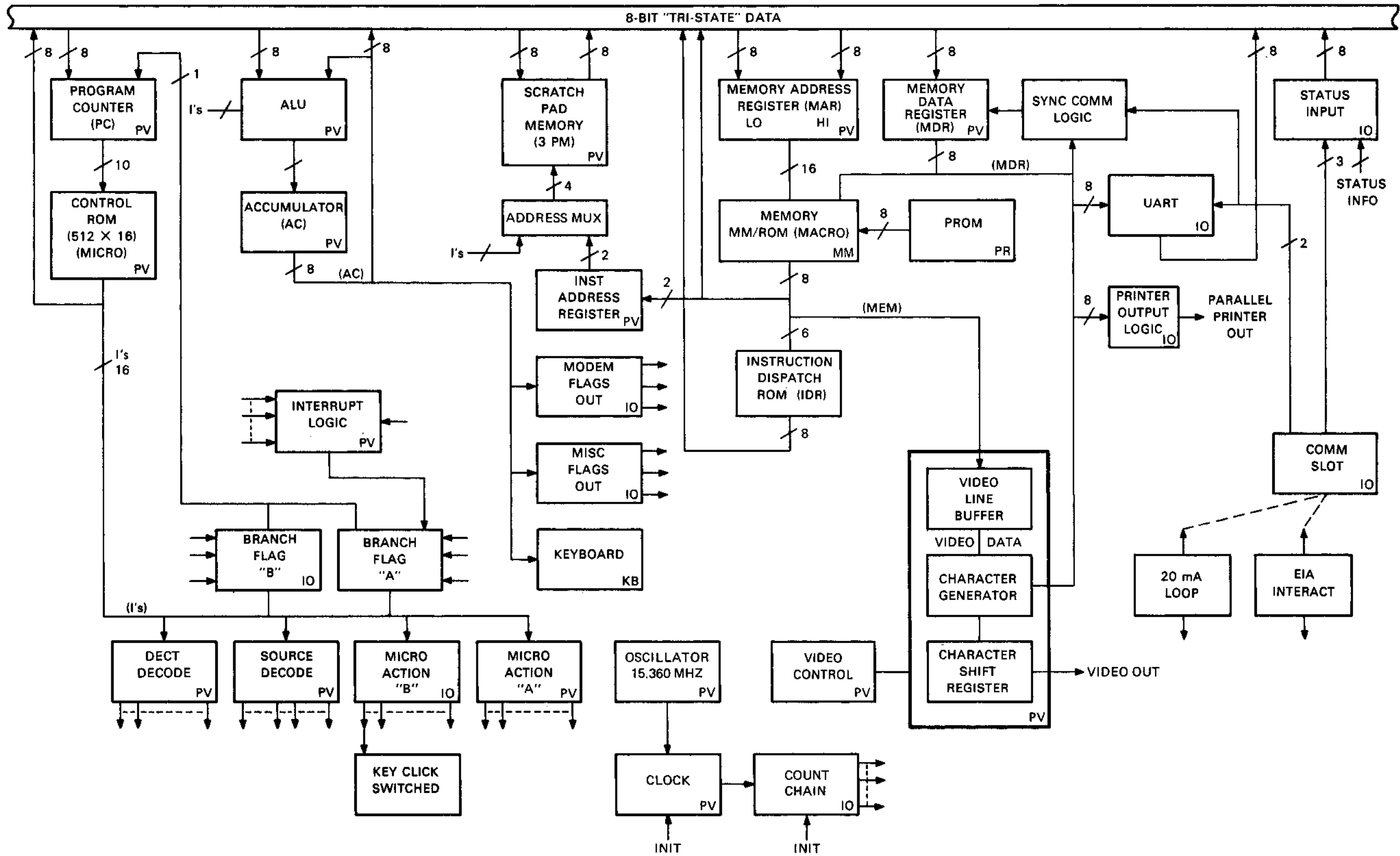

Figure 4-1 Functional Block Diagram

4.2.1 Microprocessor Description

The VT62 utilizes an internal microprocessor rather than discrete logic alone to perform individual functions. Three categories of memory are used in the microprocessor, not counting the read-only memories (ROMs) used to generate characters and perform other simple conversions. These types are as follows:

1. **Control ROM (CROM)**
This memory contains the microprogram in a language consisting of five instructions (MOVE, OPERATE, COMPARE, BRANCH, and arithmetic operations). The CROM program has two functions:
 - a. Decode the Macro ROM program
 - b. Perform time-sensitive functions such as video service.

The size of the Control ROM is 1K of 16-bit words.

2. **Macro ROM (MROM)**
This memory contains a macroprogram in a different language – a language in which each instruction stands for a series of CROM instructions. Each instruction in a macroprogram is called a macroinstruction. The CROM program decodes these instructions, branching to one of various routines depending on the type of macroinstruction encountered. Thus, the Macro ROM program language can have a very sophisticated repertoire without requiring excessive decoding logic.

The macroprogram contains 8192 8-bit words.

3. **Random Access Memory (RAM)**
This memory contains both the data displayed on the screen and scratch pad storage used by the macroprogram to store variable data. It is the only memory whose contents may change.

There are 8K of 8-bit words of RAM used in the VT62.

The overall device concept is that basically a group of registers are strung together on an 8-wire bus, called the tri-state data bus (top of Figure 4-1).

The eight data wires that make up the tri-state data bus run completely across the device and access all of the microprocessor's major registers. This bus has a cycle time of 650 ns.

The first major element of the microprocessor is the program counter, located at the left of Figure 4-1.

The letters "PV" in the bottom-right corner of the program counter functional block stand for processor/video. When they appear in a block, it means that the unit or function described by the block is located on the processor/video board.

The program counter is a 10-bit incrementing register whose basic purpose is to supply an address to the control ROM (CROM). In the implementation of the terminal functions, 1024 words of ROM are used. To address 1024 words, only 10 bits are needed. The program counter continues to increment or increase its address as it steps through the control ROM program. When it is necessary for the control ROM program to branch, a control signal (shown at the top right side of the block) enters the program counter and forces it to branch. Branching means that instead of incrementing, the program counter is loaded with eight bits of data that come from the data bus. The outputs of this program counter are the address lines to the control ROM.

The control ROM is 1024 words long and 16 bits wide. This means that there are 1024 program steps that can be uniquely addressed by the program counter. The output of the control ROM supplies 16 signals – 1 for each of these 16 bits. The 16 signals leaving the control ROM are called “I-bits” (instruction bit). The microprocessor uses these I-bits to control and manipulate each of the registers or each of the actions of the machine. The control ROM is the control memory for the microprocessor.

The microprocessor used in the VT62 is a fairly complex structure, divided into a “macro-machine” and a “micro-machine.” The micro-machine is essentially hardware; it is direct wires that control bits that control gates that do single actions. The macro-machine is basically a software machine: it is a higher level of instruction that manipulates many micro-instructions. One macro-instruction will cause many micro-instructions to happen.

The second major element of the microprocessor is the decoder logic.

The micro-machine, as previously stated, is basically hardware. The output of the control ROM consists of 16 wires, 1 wire for each bit of the micro-instruction. The control ROM output is passed to the decoder logic of the micro-machine. The decoder logic is shown at the lower-left corner of Figure 4-1.

The decoder logic comprises the following blocks: Branch Flag A, Branch Flag B, the Destination Decoder, the Source Decoder, Micro-Action A, and Micro-Action B. These decoder logic blocks decode the 16 bits of the instruction word from the control ROM (the I-bits) into whatever action must take place within the micro-machine. The most important part of the decoder logic is the destination decoder.

Four of the I-bits from the control ROM go into the destination decoder. Essentially, the destination decoder is a mux (multiplexer) that tells each of the registers in the micro-machine when to load data from the tri-state data bus.

Four more of the I-bits from the control ROM are applied to the source decoder. The source decoder is a mux which defines the register or flip-flop that is to be enabled to the tri-state bus.

As an example of how these decoders are used, the source decoder might request the accumulator to connect to the bus. The 8-wire data bus would then be connected to the accumulator. Next, the destination decoder might request the scratch pad memory to load from the bus. Data would then pass from the accumulator to scratch pad memory under control of these two decoders. The source and destination decoders are the most important blocks in the micro-machine for controlling what goes on and off the tri-state data bus.

The next use of these I-bits is in terms of micro-action A and micro-action B. A micro-action is a single event which occurs as defined by these I-bits. For example, three I-bits come down from the control ROM and enable one of eight different micro-action A events. The micro-action A events are basically the micro-machine types of actions such as incrementing the accumulator or shifting the memory data register. In addition, there is a larger group of micro-actions called the B micro-actions. Note that the B micro-actions are located on the input/output (I/O) board. This is because the B micro-actions do things such as set the key click – things that are I/O-related actions. The I-bits also go to branch flag A and branch flag B.

The I-bits select which of the various signals the branch flag A logic (located on the processor/video board) is to look at and pass on to the program counter to allow it to branch. The branch flag B logic, located on the input/output board, operates in much the same way, except that it is related to the input/output functions on the I/O board. These I-bits typically select a single branch flag to be tested to see whether or not the program counter is forced to load eight new bits of address data from the data bus instead of incrementing to the next address. Note that the branch signal which comes from

the branch logic is the control signal that tells the program counter to load. To review the I-bits; the I-bits are decoded by the decoding logic; the decoding logic consists of the source decoder, the destination decoder, micro-actions A and B, and branch flags A and B.

The source and destination decoders control the bus, the micro-actions control the single events, and the branch logic determines which flags to look at.

One input to the branch flag A block comes from the interrupt logic block. The interrupt logic receives various signals from other areas of the micro-machine. This logic controls some specific branch flags. The program has the ability to determine whether to look at a group of branch flags or instruct the interrupt logic to turn off those flags so that when the program comes around to test those flags, it will not branch. Thus, the interrupt logic is specialized logic that can enable or disable some specific branch flags.

In the overall device design, the control portion of the microprocessor comprises the decoder logic, the control ROM (which contains the instruction sequences to be executed), and the program counter (which counts through the individual program instructions).

The first register to be discussed is the accumulator. The accumulator (located on the processor/video board) is an 8-bit register that can perform an increment on command. The output of the accumulator is placed on the tri-state data bus (if the source decoder selects it). The accumulator receives its input (eight bits of data) from the arithmetic logic unit (ALU).

The ALU performs arithmetic and logic functions, and has two inputs: an A input and a B input. The logic of this ALU is such that upon command of three of the I-bits, it will do things like add input A to input B, with the result (or output) of the ALU being A plus B. Or, it can subtract A from B, add A to itself and shift in various directions, etc. Although the ALU is capable of 32 functions, we use only 8 functions in the VT62.

The ALU, in one of its states, passes data from the tri-state data bus to the accumulator.

The fundamental operation of the accumulator is, on one cycle, to load data from some register via the ALU, and on another cycle, transfer the accumulator contents back onto the bus. Thus, the accumulator is a temporary holding register that can increment, and it contains the result of the ALU computations.

Notice that the ALU receives one input from the tri-state data bus and one input from the accumulator. Therefore, a typical operation that the ALU performs is to add or subtract the accumulator contents with what is on the data bus and place the result back into the accumulator.

The next register is called scratch pad memory. (The scratch pad memory block is located to the right of the ALU in Figure 4-1.) Scratch pad memory (physically located on the processor/video board) comprises 16 8-bit registers. These 16 registers are addressed by 4 address bits from the address MUX (shown below the scratch pad memory block in Figure 4-1). Scratch pad memory receives its eight bits of input data from the tri-state data bus and drives eight bits of data back onto the bus. The four address bits define the particular 8-bit register within scratch pad memory that is used to receive and drive the eight data bits.

The third register in the micro-machine to be discussed is in the memory group. It is called the memory address register (MAR). The memory address register (located to the right of scratch pad memory in Figure 4-1) is a 16-bit register. Since the tri-state data bus is only eight bits wide, the memory address register is loaded in two sections. Usually the lower half of the MAR is loaded first with eight data bits from the bus. The upper half of the MAR is cleared when the lower half is loaded; then the upper half

is loaded with another eight bits from the bus. The result is a 16-bit address. The MAR is an incrementing register. It can increment and be loaded (in two load cycles). The output of the memory address register is the 16-bit address for the memory (which comprises the screen RAM and the macro-ROM). Since the memory address register is not a source location for the tri-state data bus, but rather a destination, the bus can only load the MAR; the MAR cannot place data on the bus.

The memory data register (MDR) is located to the left of the memory address register in Figure 4-1. Physically, it is located on the processor/video board. The MDR is the 8-bit register that supplies the data bits that are written into the screen RAM section of the machine memory. The MDR, like the memory address register, is not a source onto the bus, only a destination. This means that the MDR can only be loaded from the tri-state data bus.

Finally, there is the micro-machine memory. The memory block is located below the memory address register block in Figure 4-1. Physically, the micro-machine memory is located on the memory module (board). The memory is artificially divided into two sections: random-access memory (RAM) and read-only memory (ROM).

The RAM section of the micro-machine memory contains the data displayed on the screen. It is the only section of the micro-machine memory whose contents may change.

The ROM section of the micro-machine memory contains a macroprogram in a language in which each instruction represents a series of control ROM (CROM) instructions. This macroprogram determines the characteristics of the terminal (i.e., whether the terminal is a VT62, a VT61, or a VT61/t).

The micro-machine is divided into two sections by the highest memory address bit (from the memory address register), memory address bit 15 (MA15). Since the total address space available (16 bits) provides 64K (64,000) words of addressing, bit MA15 provides the switch between the lower 32K and the upper 32K of memory space. The screen RAM is located in the lower 32K address space (bit MA15 is low). The macro-ROM is located in the upper 32K of address space (bit MA15 is high).

The random access section of the micro-machine memory receives its input data from the memory data register.

Remember, the memory module ROM contains a macroprogram in a language where each instruction word stands for a series of control ROM instructions. The control memory ROM decodes the instructions sent by the memory module ROM by branching to one of many various routines depending on the type of instruction word encountered. The memory module ROM contains 8K 8-bit words which are used to implement the various routines in the control ROM.

In summary, the major parts of the micro-machine are the program counter, the control memory (control ROM), the decoder logic, the ALU, the accumulator, scratch pad memory, the memory address register (MAR), the memory data register (MDR), and the micro-machine memory (which comprises the screen RAM and the macro-ROM).

The device clock comprises the three functional blocks to the right of the decoder logic in Figure 4-1. The clock consists of a 15.36 MHz ($\pm 0.01\%$) oscillator (with an approximate cycle time of 65 ns) and the clock logic (which provides timing for the video logic and the universal asynchronous receiver-transmitter). The oscillator and the clock logic are located on the processor/video board. The count chain logic is located on the input/output board.

The 65 ns pulse stream from the oscillator drives the clock logic to produce the time states which clock the microprocessor. These time states determine the occurrence of all functions within the microprocessor. Ten time states are generated during each timing cycle: T0-T9. Each time state is a 65 ns pulse which occurs once in the 10 intervals of the timing cycle. This means that a particular time state (or 65 ns pulse) occurs every 650 ns, which is the major cycle time of this microprocessor. The clock pulses are passed to the count chain logic. The count chain provides the timing for the video logic and the universal asynchronous receiver-transmitter (UART).

Two microprocessor blocks remain to be examined: the blocks that make up the macro-machine. These blocks are the instruction dispatch ROM (located below the memory block in Figure 4-1) and the instruction address register (located to the left of the memory block in Figure 4-1).

When an instruction word leaves the macro-ROM section of the machine memory, the instruction dispatch ROM receives six bits of the 8-bit memory word. (These six bits make up the operation code of the macro-processor.) The ROM converts these six bits to an 8-bit address that goes onto the tri-state data bus and is loaded into the program counter.

The instruction address register is a 2-bit holding register that receives the other two bits of the memory instruction word. When appropriate, these bits are used as a partial address for scratch pad memory.

The microprocessor used by the VT62 comprises the macro-machine and the micro-machine.

4.2.2 Video Logic Description

The video logic functional block is located to the right of the instruction dispatch ROM block on Figure 4-1. Physically, this logic is located on the processor/video board.

The VT62 uses buffered video logic. This means that the video logic accesses the microprocessor only once per line on the screen; not every scan of the line. Since the VT62 uses a 24-line screen, the microprocessor is accessed only 24 times per vertical scan interval.

The video line buffer is a dynamic 80-character, 8-bit shift register. This buffer accepts 80 characters directly from the screen RAM on command. The 8-bit output of this buffer (which defines specific characters) drives the character generator. The character generator converts the data bits into video information. The video information is passed to the character shift register where it is held until the appropriate time for it to be displayed on the monitor screen.

The video control functional block is located to the left of the video logic block on Figure 4-1. Physically the video control logic is located on the processor/video board.

The video control logic determines the last scan of a character, the appropriate time to load new data into the video line buffer, and the proper time to turn off the stream of video information to the monitor to prevent character display during monitor flyback.

In summary, the video logic comprises the 80-character by 8-bit video line buffer, the character generator, the character shift register, and the video control logic. The video logic can be considered a peripheral output device to the terminal microprocessor.

4.2.3 Communications Interface and Control Logic Description

The universal asynchronous receiver-transmitter (UART) is located to the right of the memory data register on Figure 4-1. Physically, the UART is located on the input/output board.

The UART is an input/output (I/O) device that converts 8-bit parallel data input to serial data output acceptable to the communications interface adapter. The UART also accepts serial data from the communications interface adapter and converts this serial data input to an 8-bit parallel data output that is placed on the tri-state data bus.

The communications functional blocks are located in the lower right corner of Figure 4-1. These blocks consist of the communications slot and the several communications interface adapter cards that can be plugged into this slot. Physically, the communications slot is located on the input/output board.

The communications slot is essentially a plug socket that accepts one of the various communications interface adapters that is used.

The 20 mA current loop interface module is a logic level converter that buffers the transistor-transistor logic (TTL) level signals of the terminal and converts them to current pulses for transmission to the host processor. A TTL-level binary 1 is converted to a marking current of approximately 20 mA. TTL-level binary 0 is converted to a spacing current of approximately 0.4 mA.

The EIA interface module complies with the requirements of EIA Standard RS-232-C. This module is also a logic level converter that buffers the TTL-level signals of the terminal and converts them to bipolar voltage signals that can be transmitted (via a modem) to a host processor located some distance from the terminal. The output of the EIA interface module can be any voltage between +3 V and +25 V in the positive direction and between -3 V and -25 V in the negative direction. A TTL-level binary 1 is covered to a voltage level more positive than the voltage level which represents a TTL-level binary 0.

The status input block is located in the upper right corner of Figure 4-1. Physically, this functional area is located on the input/output board.

The status input logic collects data from eight input lines and places this data on the tri-state bus upon request from the source logic. Three lines come from the communications slot. These lines carry modem status information (i.e., modem carrier detect; modem clear to send data). The other five lines bring status information from various places around the terminal. For example, one line reports the status of the printer.

The modem flags out functional block is located below the instruction address register block in the middle of Figure 4-1. Physically, the modem flags out logic is located on the input/output board. The modem flags out logic consists of a holding register driven by the accumulator, under command of the micro-action A and B pulses. The three data bits supplied by the accumulator are held in this register and used to control the communications interface.

The miscellaneous flags out functional block is located below the modem flags out functional block in Figure 4-1. Physically, this logic area is located on the input/output board.

The miscellaneous (MISC) flags out logic consists of an 8-bit holding register driven by the accumulator, which is loaded under command of the micro-action A and B pulses. The data bits supplied by the accumulator are held in this register and used to control various functions within the machine.

4.2.4 Keyboard Logic Description

The keyboard functional block is located below the MISC flags out functional block in Figure 4-1. Physically, this functional area is a separate module.

The keyboard is basically a switch matrix. Every key (except the CAPS LOCK key) has a unique address representing its position in the matrix. The accumulator is used to detect keys that have been activated. When a key is pressed, a signal is passed to the branch logic. The accumulator contains the address of the pressed switch and the microprocessor responds accordingly upon detecting a pressed key.

4.2.5 Printer Output Logic Description

The printer output logic functional block is located below the UART block at the right of Figure 4-1. Physically, the printer output logic is located on the input/output board.

The printer output logic comprises a set of buffers that pass data and control signals from the microprocessor to a parallel input printer (i.e., the LA180 DECprinter).

4.3 MODULE DESCRIPTION

The complete logic package for the VT62 has been assembled on three modules: the processor/video (P/V) board, the input/output (I/O) board, and the memory board. The following paragraphs provide a description of the major logic assemblies located on each module.

4.3.1 Processor/Video Board

The program counter, the control ROM, the decoding logic, the branch flag A logic, the interrupt logic, the accumulator, the ALU, scratch pad memory, the instruction address register, the clock logic (excluding the count chain logic), the memory address register, the memory data register, the instruction dispatch ROM, and the video logic are located on the processor/video board.

4.3.2 Input/Output Board

The branch flag B logic, the micro-action B logic, the count chain logic, the modem flags out logic, the MISC flags out logic, the UART, the communications slot, the status input logic, and the printer output logic are located on the input/output board.

4.3.3 Memory Module/PROM Module

The random access memory for the terminal is contained on the memory board. The terminal read-only memory, or macroROM, (which contains the 8192 8-bit word macroprogram for the terminal) is located on the PROM board. The macroprogram determines the operating characteristics of the terminal.

4.3.4 Keyboard

The keyboard is a separate module arranged so that the keys form an 8 × 10 matrix. Every key (except CAPS LOCK) has been assigned a unique identifying number representing its position in the matrix. The accumulator is used to detect keys that have been activated (typed). Any key can be checked by placing its identifying number into the accumulator. If the key is not down, keyboard output signal KEY UP H will be TRUE.

The program polls the keyboard during the horizontal retrace time of the monitor. This is accomplished by loading the accumulator with the lowest key number and entering a program loop that continually increments the accumulator and tests the result until an activated key is found or until all of the keys have been tested. When an activated key is found, a signal is passed to the branch logic using the switch address provided by the accumulator and the microprocessor responds accordingly.

4.4 MONITOR CIRCUITS

The monitor circuits include a cathode ray tube (CRT), horizontal and vertical deflection circuits to position the electron beam leaving the cathode, and a video amplifier to modulate that beam with the signal from the video logic.

4.4.1 CRT

Figure 4-2 is a diagram of the CRT used in the VT62. It consists of a heater, an electron-emitting cathode, a control grid for biasing, a focus grid for shaping the beam, a screen grid for accelerating the beam, and a high voltage anode for attracting the beam to the phosphor-coated face of the tube (screen). The beam strikes the screen at a high velocity causing the phosphor to give off light. Magnetic fields produced by driving current through the horizontal and vertical deflection coils (yoke drivers) deflect the beam left and right and up and down. The angle of deflection is proportional to the strength of the magnetic field which is proportional to the current flowing through the coil.

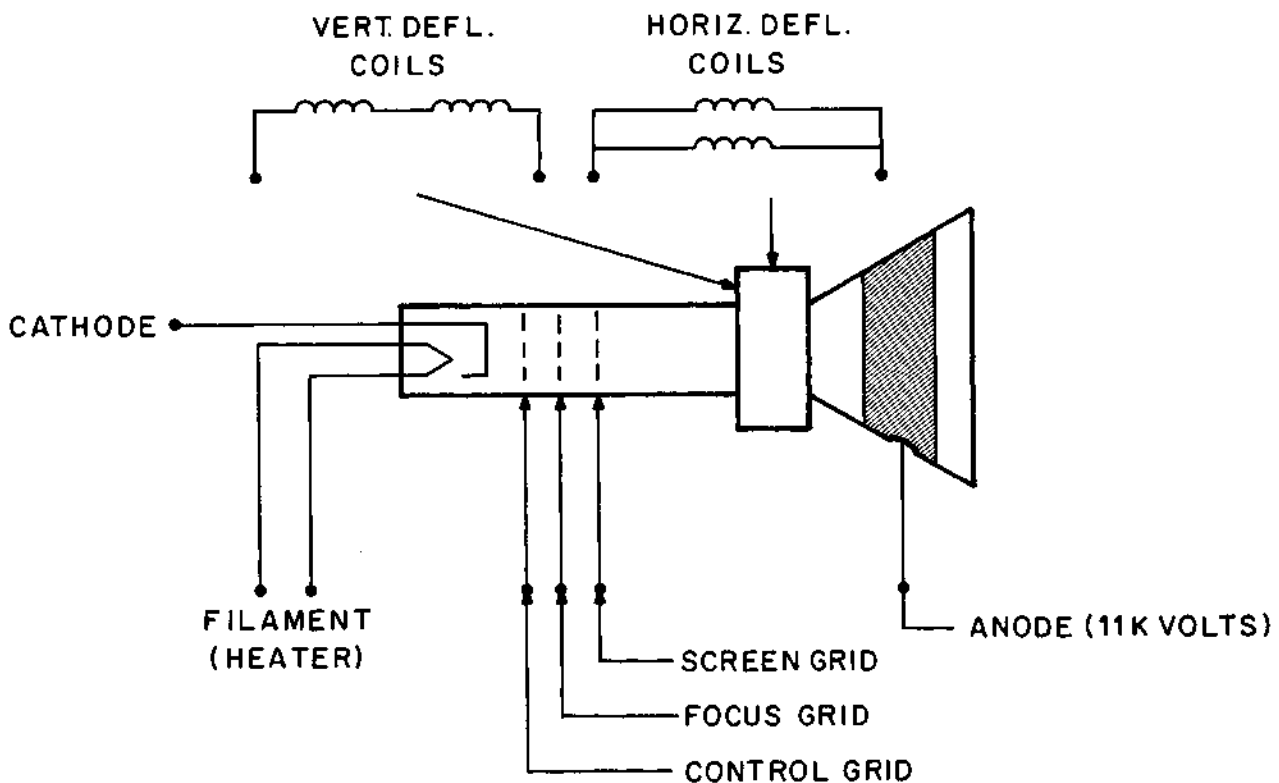

CP-2300

Figure 4-2 Cathode Ray Tube Diagram

4.4.1.1 Beam Deflection – Field strength is proportional to current; therefore, if the current through the coils is steadily increased, the magnetic field will also increase and the beam will deflect from left to right and from top to bottom, an amount proportional to the increase in current. If the currents are quickly returned to their original value, the beam will quickly return to its original position.

Figure 4-3 shows the horizontal and vertical sawtooth current waveforms through the deflection coils. Vertical deflection is very slow compared to horizontal deflection. This is because 240 horizontal scans occur for each vertical scan in 60 Hz units; 50 Hz units have 264 horizontal scans per frame. During vertical retrace time, the beam makes 16 additional horizontal scans.

4.4.1.2 Yoke Drivers – (Refer to Monitor drawing D-CS-5411444-0-1, sheet 2). Due to a large change in voltage per unit time and greater angle of deflection required, most of the voltage drop across the horizontal yoke is through inductance, whereas in the vertical yoke, resistance is more significant than inductance in causing the voltage differential. For this reason the two driver circuits are designed differently.

4.4.1.3 Vertical Yoke – At the center of the driving circuit for the vertical yoke is an operational amplifier (E2) in a current-sampling integrator configuration. The basic functional circuit is shown in Figure 4-4.

A power-driver stage is added by an emitter-follower (transistors Q2 and Q3). Q1 serves as a voltage-level converter. It is a common-emitter amplifier. To prevent dc leakage current from flowing through the vertical yoke, a capacitor is put in series with it. In addition, feedback is brought from the yoke back to the operational amplifier. E2's gain is 1 under dc conditions, when the resistance between the inverting input (pin 2) of E2 and ground is 100 k Ω ; under ac conditions, C5 lowers that resistance to 10 k Ω , giving E2 a gain of 10. This ensures saturation of the output of the operational amplifier, which makes the flyback cycle more effective.

Diode D9 charges capacitor C11 during vertical retrace. This reduces the current requirements of the vertical circuit during the downward scan since it uses the energy stored in the capacitor.

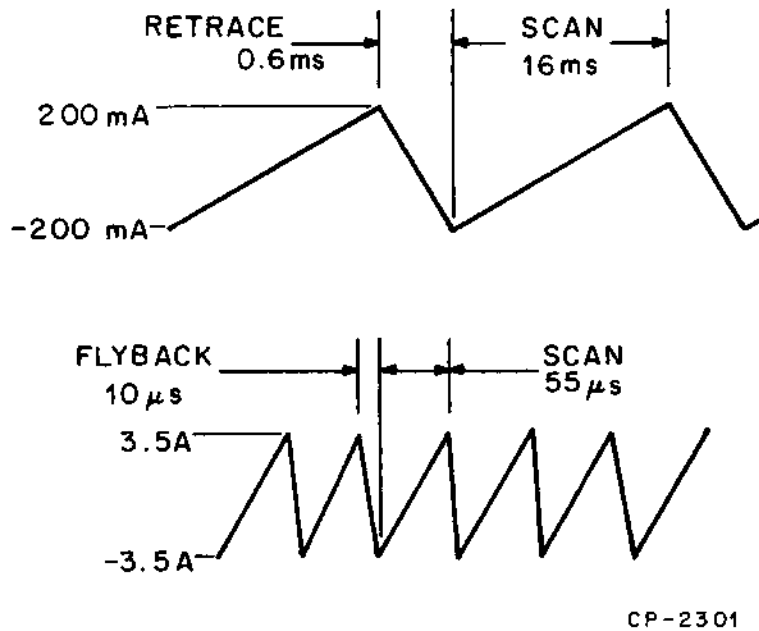
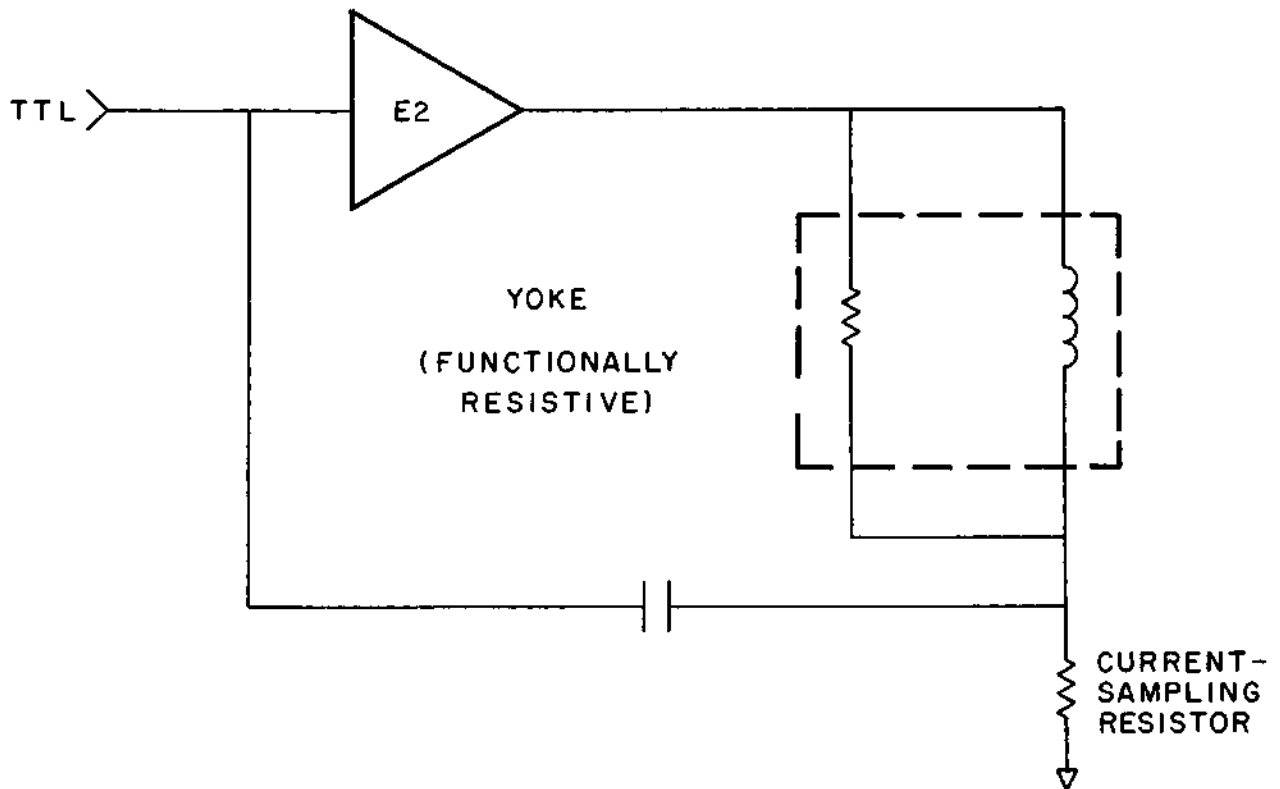

Figure 4-3 Horizontal and Vertical Current Waveforms



CP-2814

Figure 4-4 Vertical Deflection Circuit

4.4.1.4 Horizontal Yoke - The horizontal yoke is basically an inductor. By supplying a constant voltage, a constantly rising current will result which causes the horizontal scan. The momentum of this current across the coil is used to charge a capacitor which supplies the reverse voltage needed in flyback. This capacitor and the yoke form a resonant circuit. A diode is added to keep the capacitor from ringing after flyback has been achieved. As a result of flyback, the high current in the reverse direction is also sent to T1, the flyback transformer where it performs several functions:

1. It is stepped up to 11,000 V and sent through a diode to the anode of the cathode ray tube, which has a large capacitive effect. This rectifies the 11,000 V into a steady dc voltage.
2. It provides a source of several high voltages.
3. It is used to generate the third harmonic of the capacitor waveform as it charges. This signal has about 15 percent of the amplitude of the original waveform, and is added on the secondary side of the transformer and subtracted on the primary side to produce a higher voltage with the same power consumption.

Again, there is a capacitor in series with the yoke. As well as eliminating dc across the yoke, it supplies the S-correction (Figure 4-5) to the yoke. It was mentioned before that the angle through which the yoke deflects the electron beam varies directly with the current through the yoke. But this does not result in a constant rate of speed of the beam's travel across the screen; since all the points on the screen are not an equal distance from the source of the electron beam, a deflection of 1 degree, when the beam is at the center, would produce less distance change than the same deflection when the beam is at an edge of the screen. The capacitor performs S-correction by slowing down the movement of the electron beam when it is near the edges.

A variable inductor (T3) in series with the yoke is used to provide adjustment of the width of the scan.

T4, the other coil in series with the yoke, is the linearity coil. Its non-linear inductance corrects for some of the second-order effects: the resistance of the yoke and some of the voltage drops in the circuit.

The circuit at coordinates D7 uses the SYNC signal as the time base to integrate voltage sampled from pins 8 and 9 of the flyback transformer T1. A fast power transistor, which has started flyback too early with respect to the SYNC signal, will allow more current to be integrated. This circuit will compensate for the power transistor's fast storage by increasing its base current, which will slow it down. A power transistor which is too slow will likewise be compensated for by reducing its base current. Another benefit of this circuit is to guarantee that the power transistor will always be saturated when the horizontal scan begins, which will ensure its linearity.

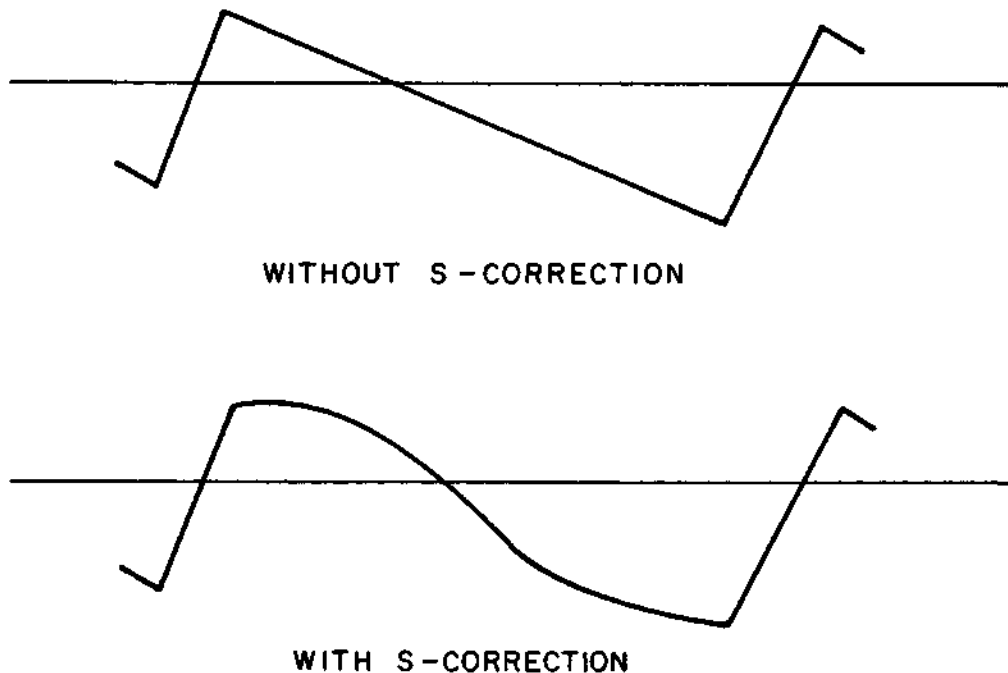

CP-2303

Figure 4-5 Horizontal Yoke Current

4.4.1.5 Video Circuits – The screen grid provides +360 V in order to accelerate the electrons emitted from the cathode to the screen.

The focus circuit supplies a voltage from 0 V to 450 V to the focus grid. R49 is used to adjust this voltage to obtain the sharpest picture on the screen.

The intensity circuit supplies from 0 V to –80 V to the control grid. R44, which is the operator control at the rear of the unit, is used to fix this voltage, regulating the general intensity of the screen. A more negative voltage will suppress the flow of electrons to the screen, producing a dimmer image.

The two levels of intensity that are used to display characters on the screen are produced as Q4 switches on and off. This will take the cathode from +40 V (dark) to +2 V (light). D14 prevents Q4 from saturating, ensuring high speed of operation.

4.5 H7832 POWER SUPPLY

The H7832 power supply converts 115 V, 60 Hz or 230 V, 50 Hz ac line voltages to voltages suitable to operate the VT62 video terminal.

The power supply uses a 20 kHz fixed-frequency, pulse-width modulated, flyback technique to reduce its size and weight and increase its efficiency over conventional power line frequency supplies.

The input power is approximately 130 W; the output power is 90 W. Four output voltages are provided:

1. +5 V @ 8.5 A
2. +12 V @ 1.35 A
3. –12 V @ 0.66 A
4. +90 V @ 0.2 A

The secondary circuitry is protected by a 0.25 A fuse in the case of the +90 V output and the over-current fold back circuits for the other outputs. The primary circuitry is protected by a 3 A normal-blow fuse. The power supply may be operated on either 115 V 60 Hz or 230 V 50 Hz by selecting the proper position on a switch mounted on the printed circuit board inside the supply.

4.6 COMMUNICATIONS OPTIONS

The communications interface may be a 20 mA current loop interface or an EIA standard interface depending on the specific application of the terminal. Each interface is mounted on a 5.08 × 15.24 cm (2 × 6 inch) card. Connector J1 on the card connects directly with the communications slot on the input/output (I/O) board (Appendix B). Cables are supplied with an interface for connecting the terminal to a host processor or modem.

4.6.1 20 mA Adapter Card (BN52B)

The 20 mA Adapter Card (BN52B) is supplied with a 4 m (13 ft), No. 22 AWG stranded 4-wire cable that terminates in an 8-pin Mate-N-Lok connector. Table 4-1 lists the cable signal names.

4.6.2 EIA Adapter Card (BN61B)

The EIA Adapter Card (BN61B) is supplied with a 5 m (16 ft) cable terminating in a 25-pin, male CANNON DB 19604-432 or equivalent connector. Table 4-2 lists the cable signal names.

Table 4-1 20 mA Interface Signals (BN52B)

Mate-N-Lok Pin No.	Signal Name	Color
7	Transmitted Data (+)	Green
3	Transmitted Data (-)	Red
5	Received Data (+)	White
2	Received Data (-)	Black

Table 4-2 EIA Interface Signals (BN61B)

Cannon Pin No.	Signal Name
1	Protective Ground
2	Transmitted Data
3	Received Data
4	Request to Send
5	Clear to Send
7	Signal Ground
8	Carrier
14	Secondary Transmit Data
15	Serial Clock Transmit
16	Secondary Receive Data
17	Serial Clock Receive
20	Data Terminal Ready

CHAPTER 5 SERVICING

5.1 SERVICE PHILOSOPHY

After the VT62 has been installed and checked out at the customer's site, it can be expected to operate error free for long periods of time. As with all electronic devices, however, the terminal may require some corrective maintenance due to a failing or marginal component. When the terminal requires service, it is recommended that service be performed at the subassembly level; the fault should be isolated to a module or other major component and the faulty part replaced with a completely tested spare. If the failing part is a module, it should be returned to an authorized DIGITAL repair depot where facilities are available for efficiently locating the faulty component. After repair and complete testing, the module can be returned to Field Service stock.

With the exception of the monitor module and the power supply, all data and control circuitry in the unit depends upon the microprocessor for timing and/or data information. Without specially designed test equipment, field testing this circuitry to the component level is difficult and time consuming and is not recommended.

The spares kit consists of a complete set of modules for the VT62.

5.2 SUBASSEMBLY LEVEL TROUBLESHOOTING

To find and repair the cause of a failing terminal, first identify the faulty subassembly and then replace it with a good spare part. Replacement procedures for all major subassemblies are described in Paragraph 5.3. To identify the faulty subassembly, analyze the symptoms and make a judgment as to which module or major component is at fault. Replacing the suspected subassembly will fix the problem or at least eliminate that subassembly as a possible cause of the problem.

5.2.1 Identifying the Faulty Subassembly

Identifying the faulty subassembly will be fairly easy in some cases and quite difficult in others. Failures to the monitor module and/or to the power supply will usually result in an obvious display malfunction, i.e., loss of horizontal or vertical deflection, no display, etc.

In some cases, you will be able to decide which subassembly is failing by analyzing the symptoms displayed on the screen. In other cases, additional keyboard tests and/or voltage and waveform checks must be made to determine the failing subassembly. To assist you in making this decision, timing waveforms and other test data are included in this chapter.

5.2.2 Analyzing the Symptoms

There are some basic checks that should be made before disassembling the unit.

1. Is the unit plugged into the outlet?
2. Is the intensity level set too low?
3. Are the BAUD RATE switches set to legal positions?
4. Are the send/receive baud rates of the terminal set to the receive/send baud rates of the host?

After determining that the VT62 is properly set up for operation and still does not work, place the unit off-line using the following procedure:

CAUTION

Ensure that the terminal line cord is not connected to an electrical outlet and that the power (ON/OFF) switch is in OFF position (Figure 5-1).

1. Place the unit upside down on a workbench or table (Figure 5-2).
2. Remove the upper cable clamp securing the option cable to the base assembly (two Phillips head screws 8-32 × 0.56).

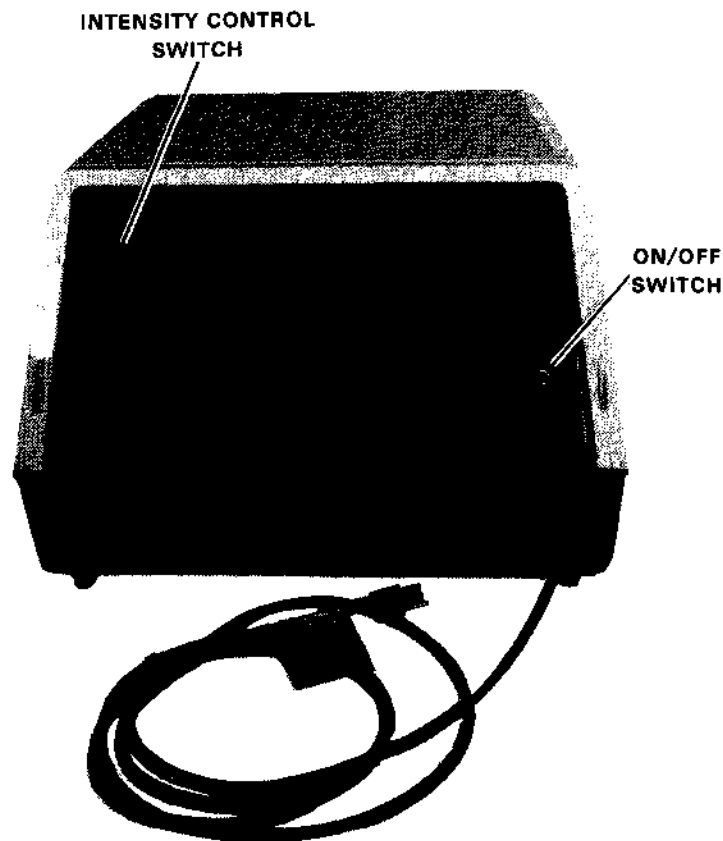

8595-5-A0004

Figure 5-1 VT62 Terminal, Rear View

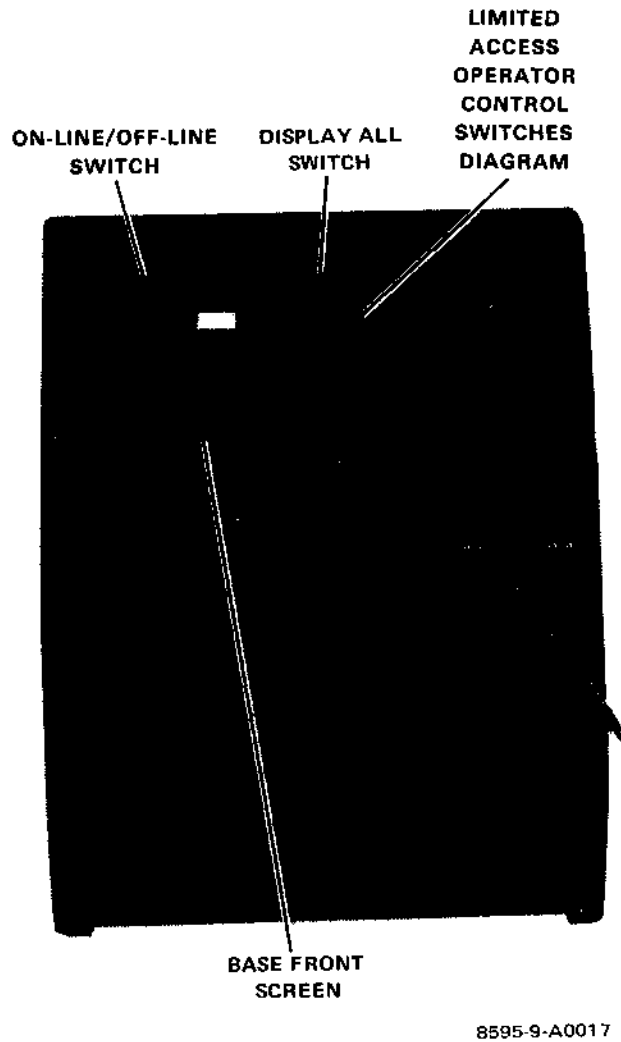

8595-9-A0017

Figure 5-2 VT62 Terminal, Bottom View,
Base Front Screen Installed

3. Remove the base front screen (three hex-head screws, 8-32 × 0.38) using a 6.35 mm (1/4 inch) nut driver.
4. Remove the switch panel board connector P1 from J4 on the I/O board (Figure 5-3).

The limited access operator control switches (a small, in-line battery of switches) should now be visible (Figure 5-4). Positions of all the defined switches are shown by a diagram mounted on the terminal base front screen (Figure 5-2).

5. Ensure that limited access switch 4 (LAS 4), the MAINTENANCE MODE switch, is in the OFF position.

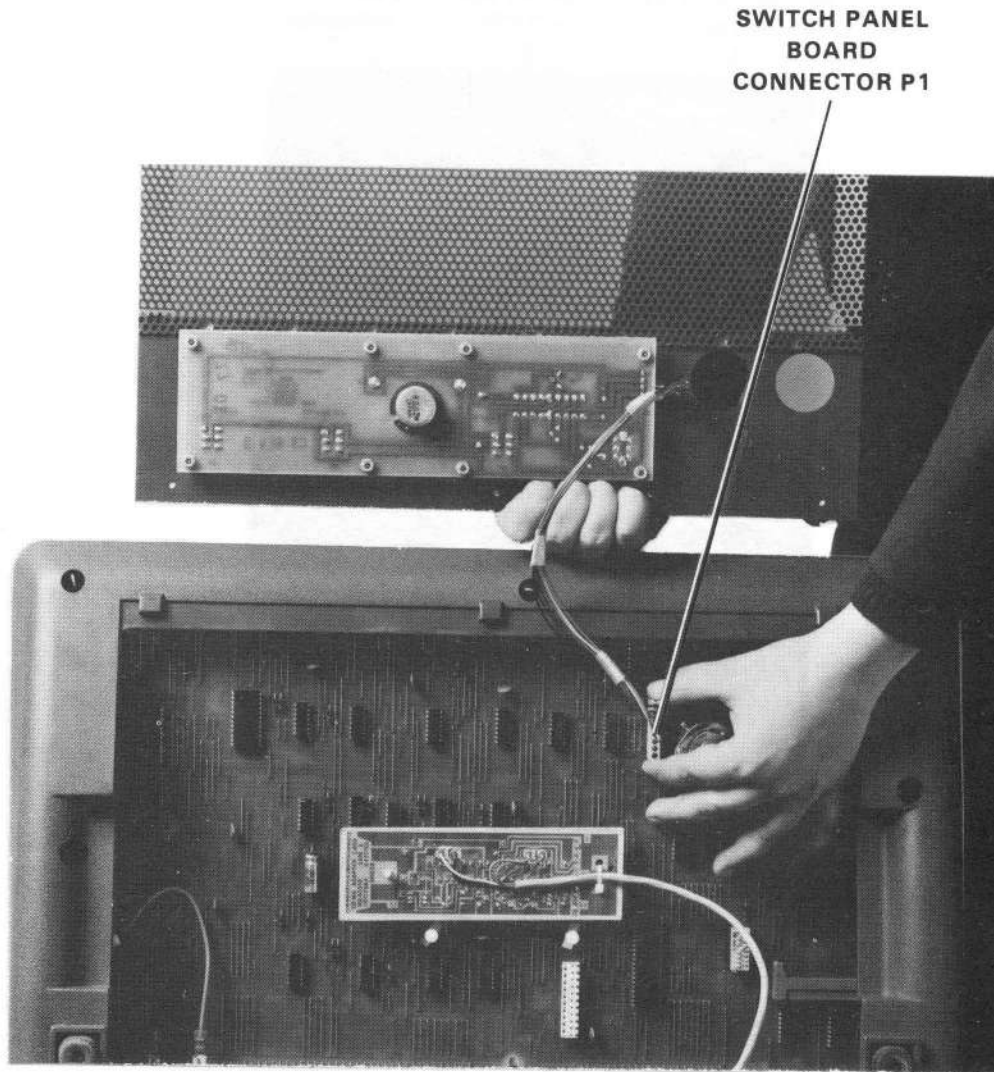

8284-14-A0008

Figure 5-3 Removing the Switch Panel Board Connector

LIMITED ACCESS
OPERATOR CONTROL SWITCHES

PRINTER
CONNECTOR

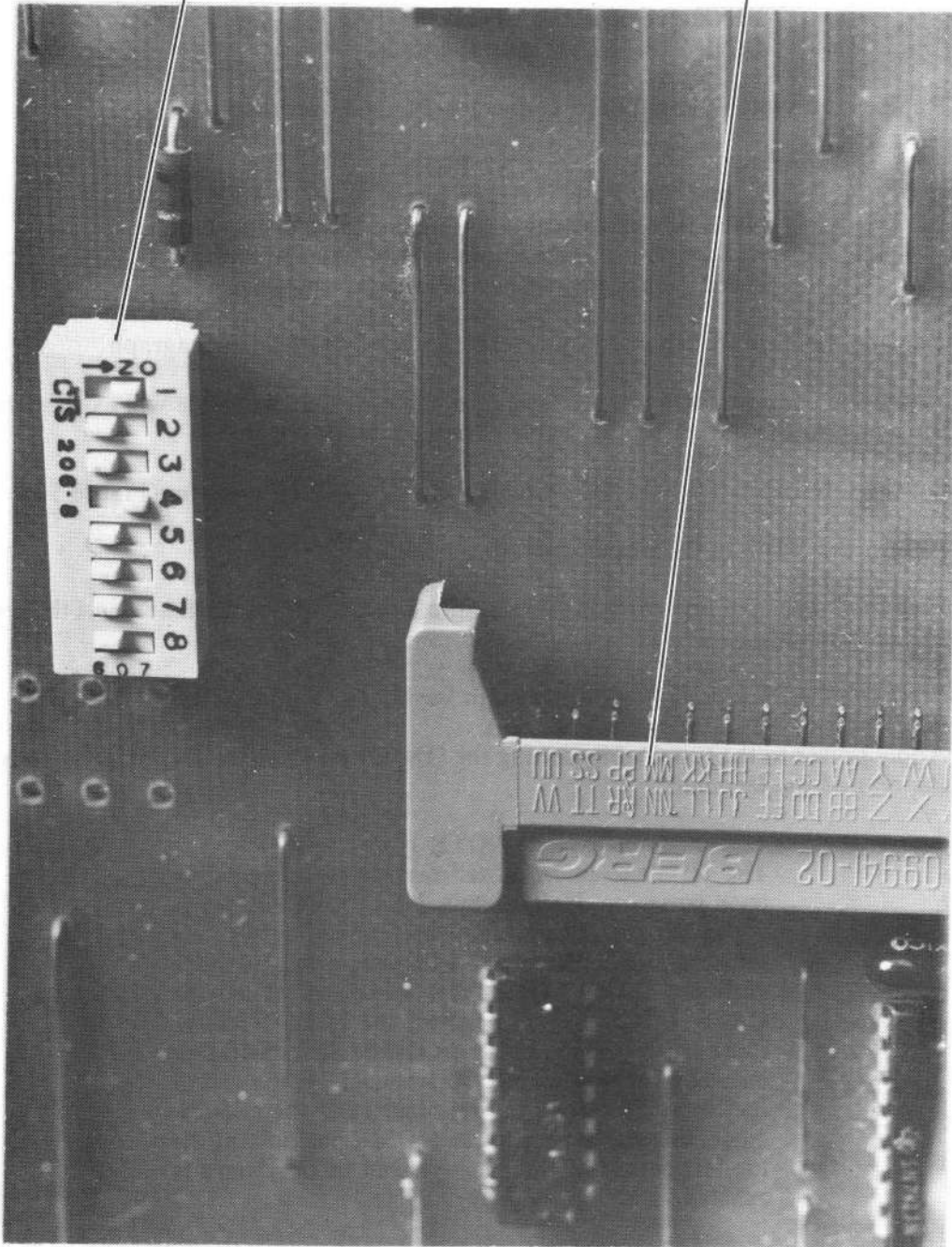

8284-25-A0031

Figure 5-4 Limited Access Operator Control Switches

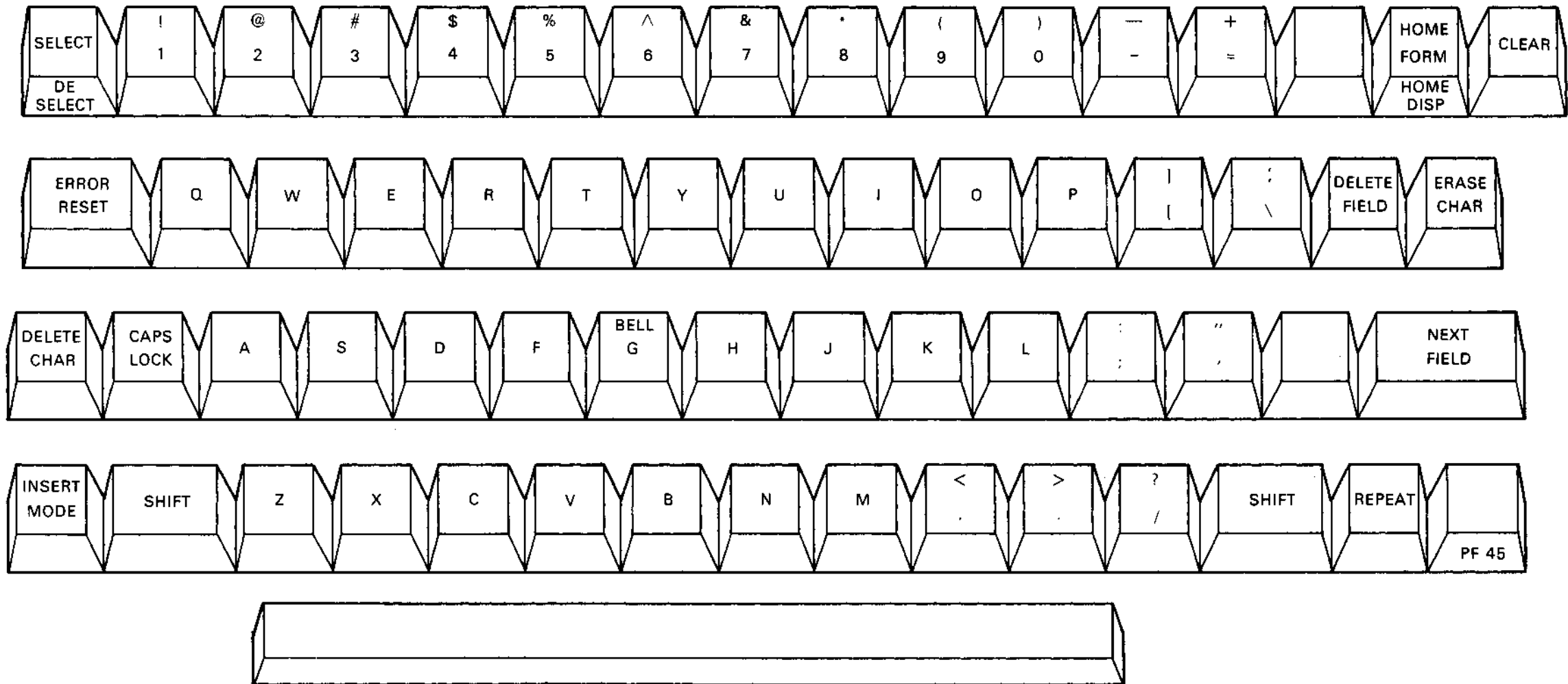

MA-0930

Figure 5-5 VT62 Keyboard

After determining that the terminal is properly set up for operation in the OFF-LINE mode, perform some keyboard tests to develop a list of symptoms and possible causes. The more symptoms that you have to work with, the better the judgment that can be made as to which part is failing. Use the following checklist to help you make your determination:

1. After warmup, is the cursor at home position and blinking? If not, go to step 2.

If the cursor is at the home position, assume that the CRT and its associated components, the monitor module, and the power supply are all functioning normally. Further testing is required. Go to step 3.
2. Is there a raster on the screen when the intensity level is set for maximum brightness? If there is no raster, the problem could be due to a defective monitor module, power supply, CRT, or deflection yoke. The problem could even result from a missing sync pulse. If there is a raster, assume that the monitor module, power supply, and the CRT and its associated components are functioning normally. A possible exception is the video amplifier circuitry on the monitor module. Go to step 3.
3. Perform the terminal self-test. Terminal self-test is invoked by typing ESC S. When this is accomplished, the terminal performs a routine that exercises the microprocessor and tests the integrity of the microprogram.

In the event of a failure of any kind in the terminal self-test, the video screen may be full of characters and the terminal may make a continuous beeping sound. The keyboard will not respond to typing and the terminal must be physically switched off and back on before use of it can continue.

By verifying the integrity of the microprogram, the self-test function relieves diagnostic programs of the necessity of testing all of the terminal functions in order to detect a ROM error which only interferes with the execution of certain functions.

If all tests are successful, the terminal will be reinitialized. If the terminal self-test fails, see the self-test diagnostic procedure located in Appendix D of this manual.

5.2.3 Voltage Checks

If testing indicates that the H7832 power supply is not functioning normally, measure the voltages listed in Table 5-1 at the test points indicated in Figure 5-6. To accomplish these measurements, the unit must be turned over on its back and the base and rear louver plate removed. The removal procedures are described in Paragraph 5.3 of this chapter.

CAUTION

Use extreme care when measuring voltages on the monitor module and the H7832 power supply. There are high voltages on both of these assemblies.

If any voltages are incorrect, replace the H7832 power supply (Paragraph 5.3) and recheck. If the voltages (measured at the test points) are correct, check these voltages at convenient points after distribution to other modules, as listed in Table 5-1 and indicated in Figure 5-6.

Table 5-1 Voltage Test Points

Subassembly	Connector Pin	Voltage
Input/Output Board	J1-2, 14	+5
	J1-4, 15, 16	GND
	J4-2	+12
	J4-3	GND
	J16-9, 10, 11	+5
	J16-3 through 8	GND
	J16-1	+12
	J16-2	-12
Processor/Video Board	J3-m, t	+5
	J3-w, x	GND
	J3-s	-12
	J17-2, 3	+5
	J17-4, 5, 6	GND
	J17-7	+12
	J17-1	-12
Memory Board	J7	+5
	J8	GND
H783 Power Supply	J1-10, 13, 14	+5
	J1-7, 8, 9, 11	GND
	J1-5, 6	+12
	J1-1, 2, 3	-12
Monitor Board	J2-5, 6	GND
	J2-4	+12
	J2-2	-12

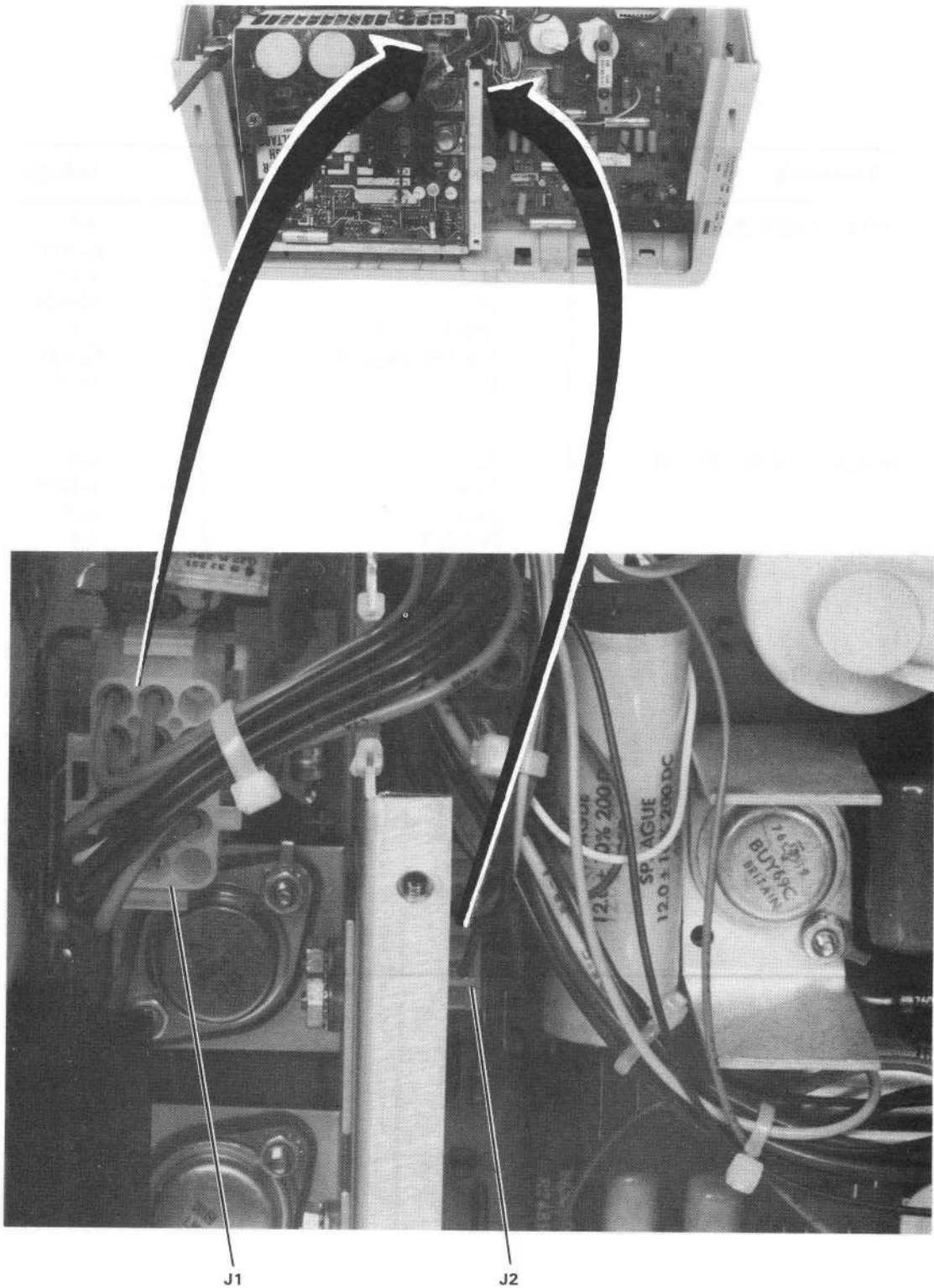

8595-11-A0021

Figure 5-6 Voltage Test Points (Sheet 1 of 3)
Power Supply and Monitor Board

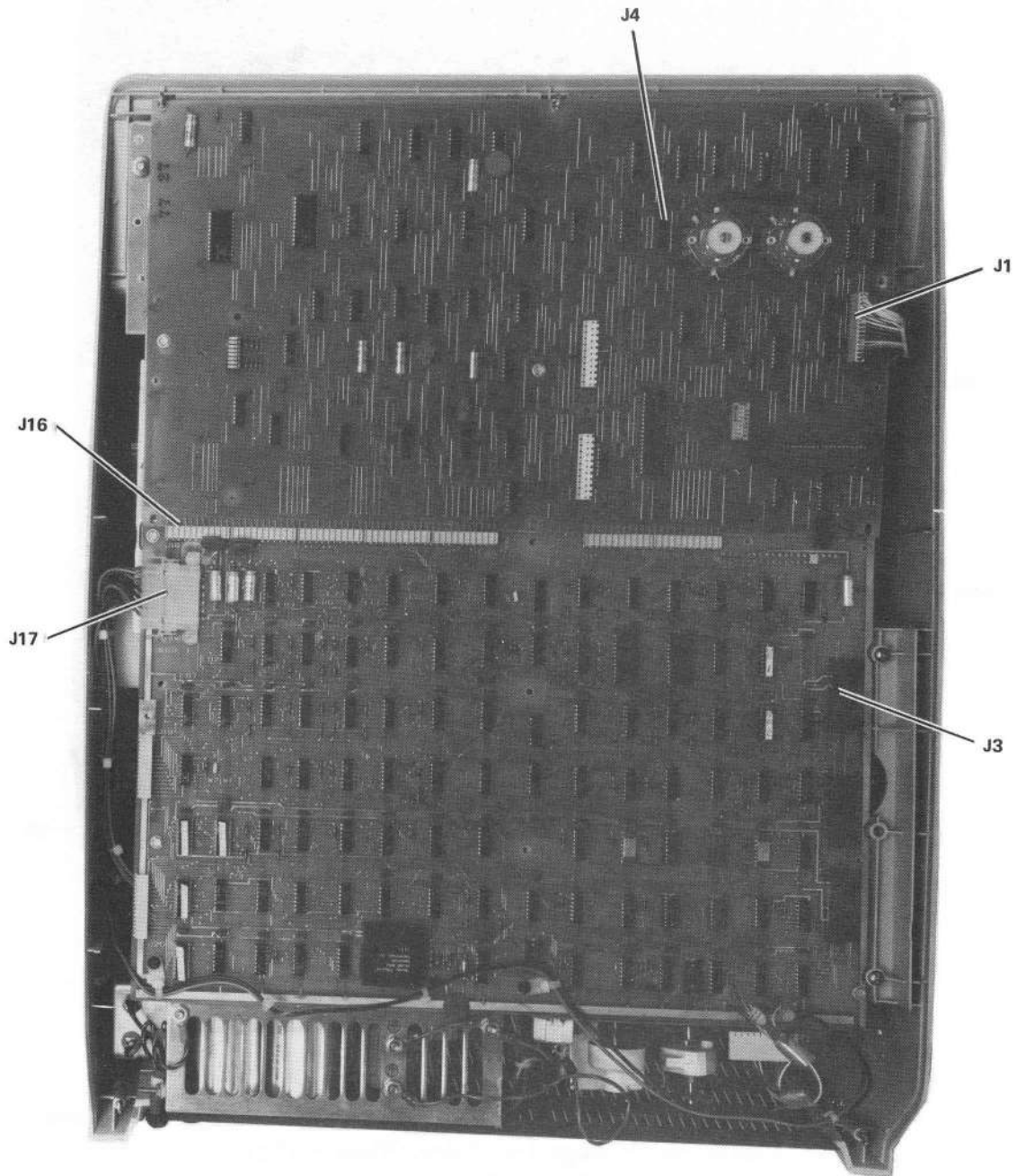

8595-4-A0014

Figure 5-6 Voltage Test Points (Sheet 2 of 3)
I/O Board and Processor/Video Board

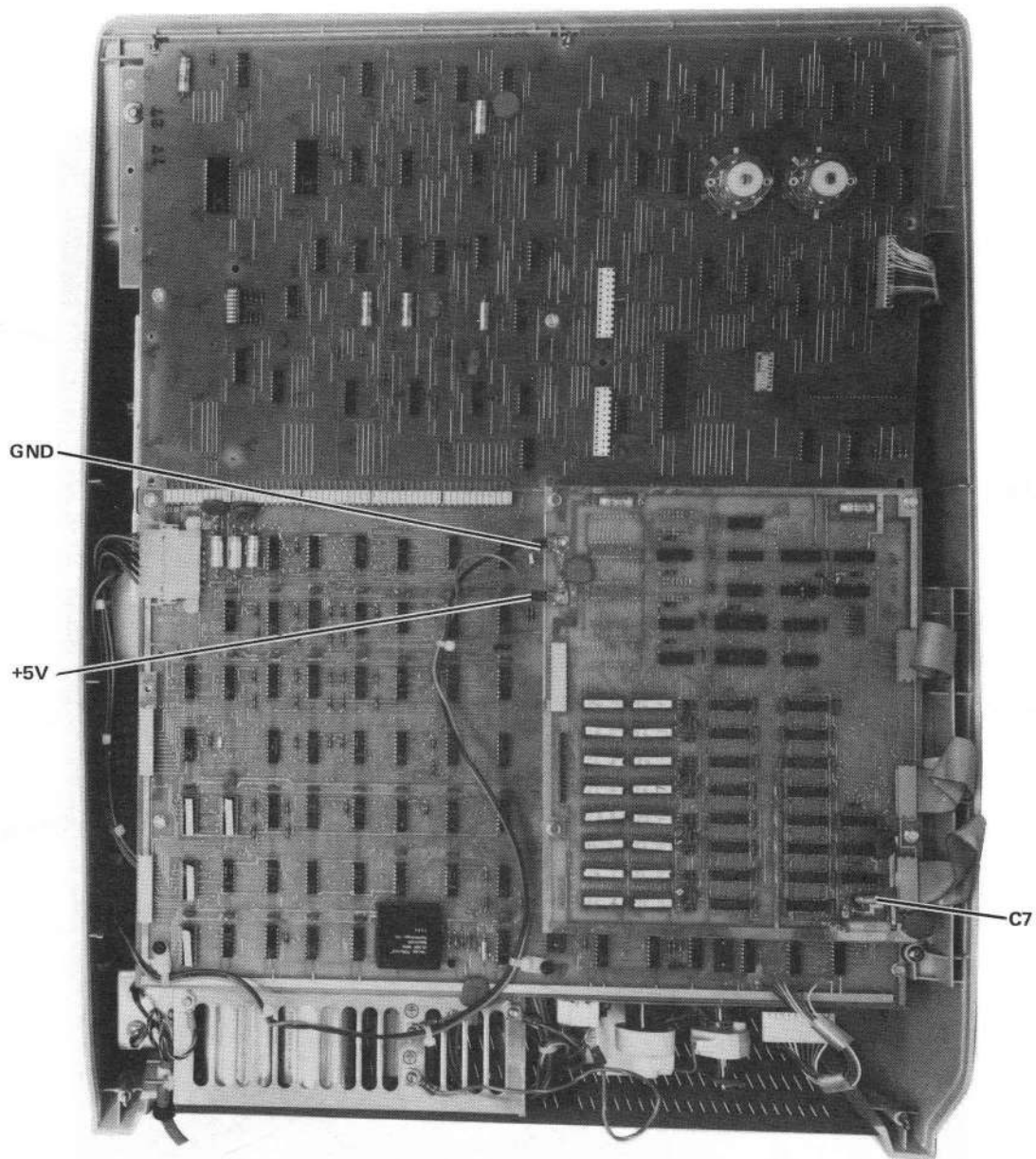

8595-3-A0013

Figure 5-6 Voltage Test Points (Sheet 3 of 3)
Memory Board

5.2.4 Monitor Waveforms

The signals illustrated in Figures 5-7 through 5-17 show the normal monitor module waveforms that one would observe in a working terminal. If you suspect that the monitor module is the cause of a failing condition, confirm or reject your suspicions by comparing the waveforms on the failing unit with the waveforms illustrated by the figures. Refer to the monitor module drawing D-CS-5411444-0-1 while making these comparisons.

Although component-level troubleshooting is not recommended when servicing this terminal, these waveforms are provided as an aid in determining a failure in the monitor module.

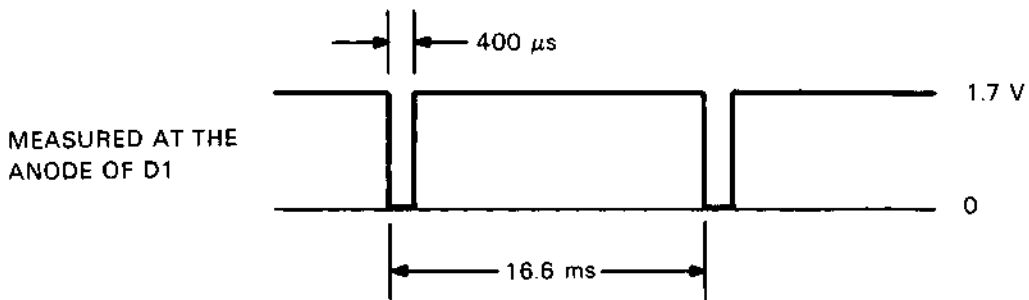

CP 2803

Figure 5-7 Monitor Test Point 1

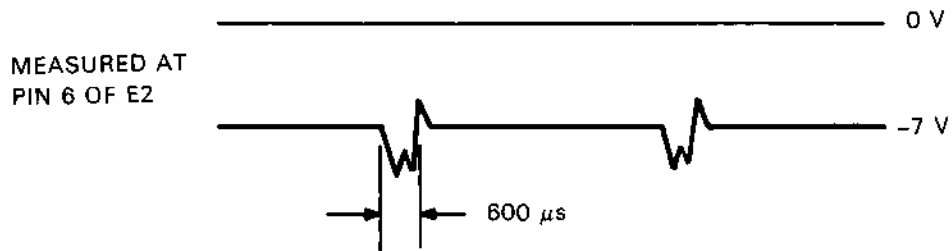

NOTE:

THE SAME PATTERN APPEARS AT BASE OF Q18 - VOLTAGE IS APPROX. -10 V

CP 2804

Figure 5-8 Monitor Test Point 2

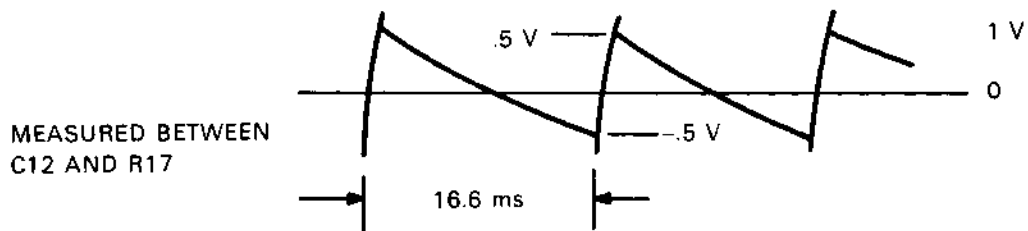

CP 2805

Figure 5-9 Monitor Test Point 3

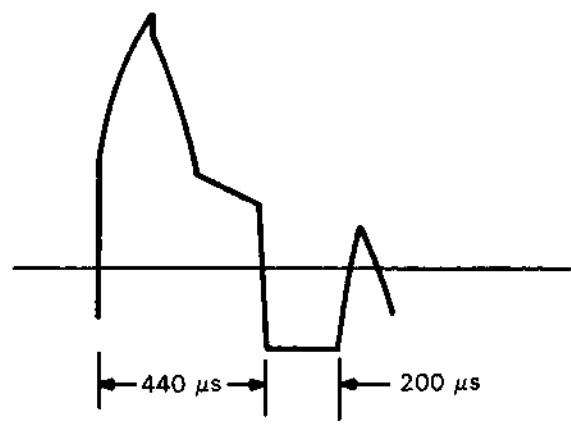
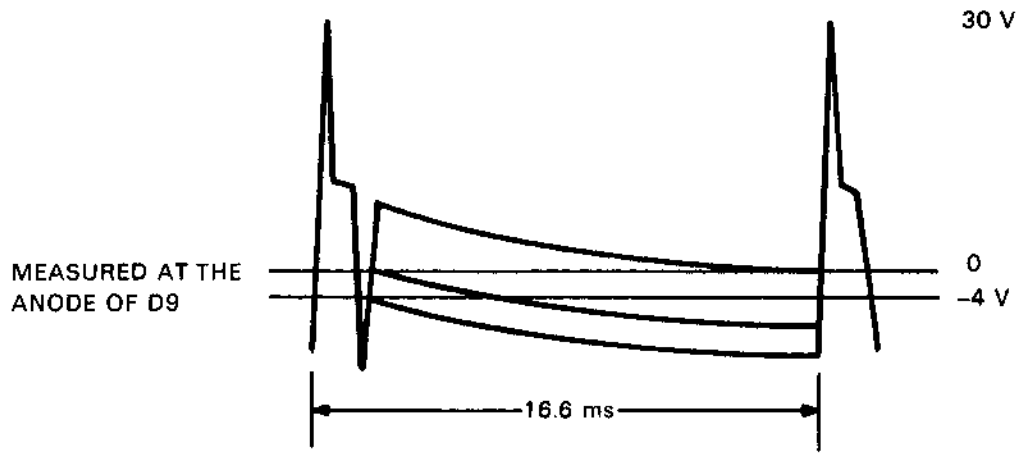

CP-2806

Figure 5-10 Monitor Test Point 4

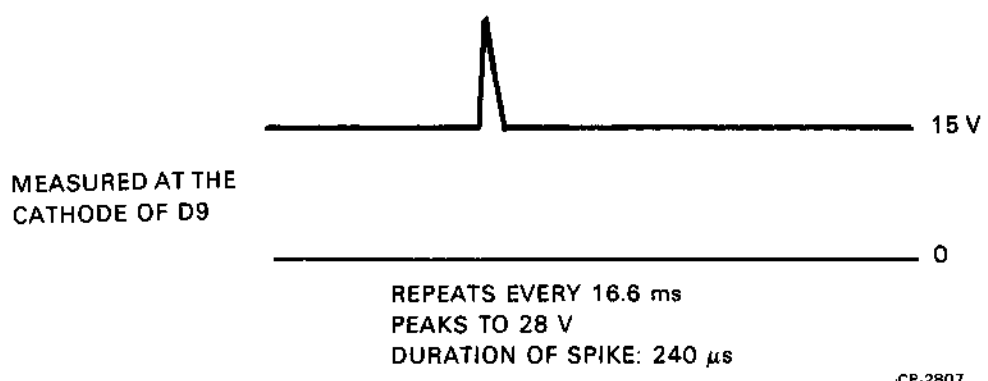

CP-2807

Figure 5-11 Monitor Test Point 5

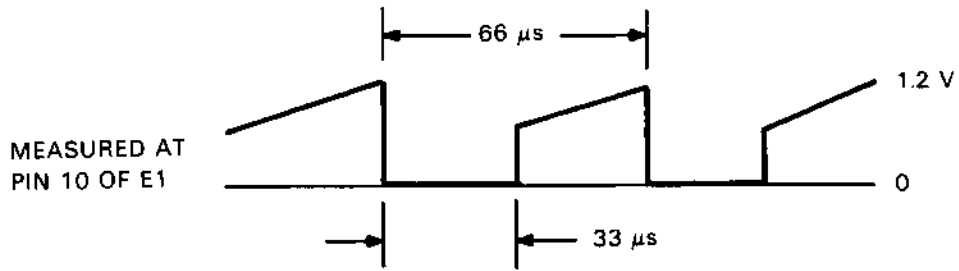

CP-2808

Figure 5-12 Monitor Test Point 6

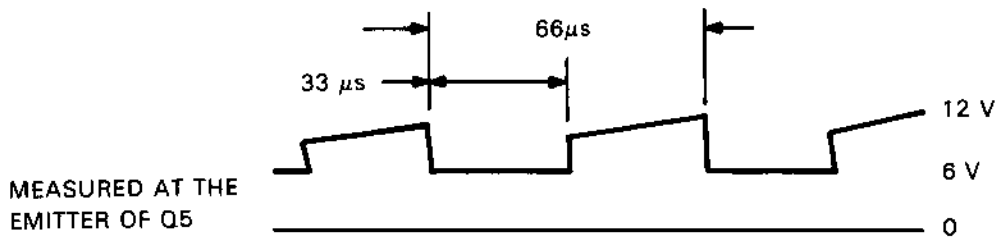

CP-2809

Figure 5-13 Monitor Test Point 7

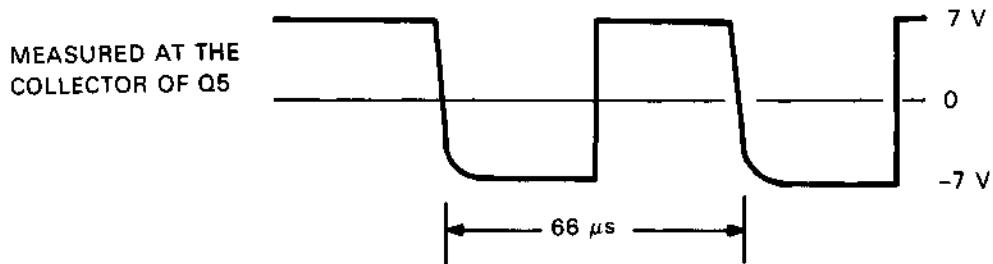

CP-2810

Figure 5-14 Monitor Test Point 8

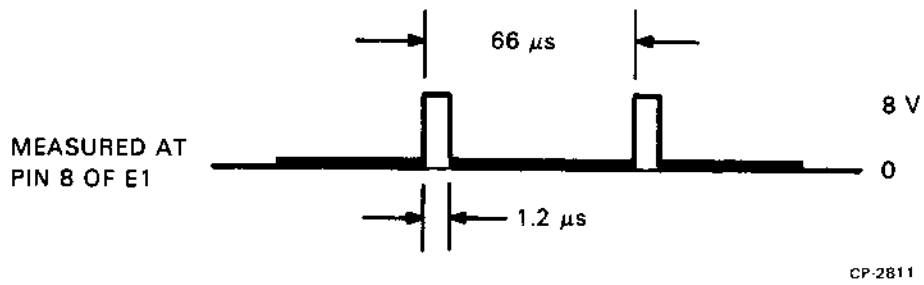

Figure 5-15 Monitor Test Point 9

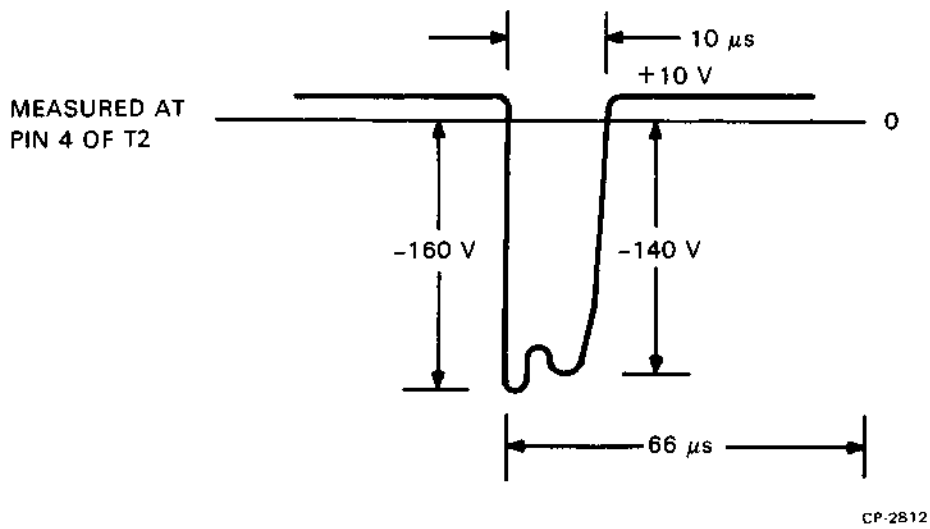
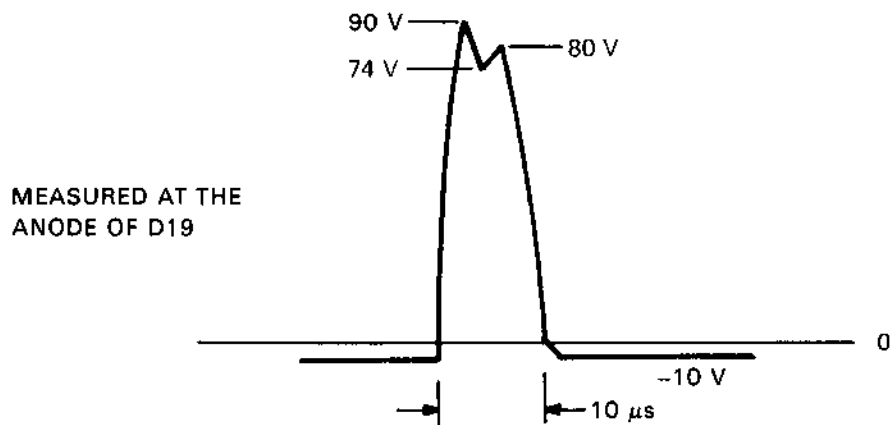

Figure 5-16 Monitor Test Point 10



TEST POINT 11, MEASURED AT THE COLLECTOR OF Q9
SHOULD BE A 9 Vdc LEVEL.

CP-2817

Figure 5-17 Monitor Test Point 11

5.2.5 Keyboard Troubleshooting Hints

If time permits, you may elect to repair the keyboard rather than replace it. This is done by performing the basic steps listed below, and then if results are not normal, making whatever tests are necessary to pinpoint the problem. The steps need not be performed in the order shown. If the symptoms show that a particular key is malfunctioning, immediately check the signals connected to the failing key.

Refer to the keyboard drawing D-CS-5411170-0-1 while making these tests.

1. Press the Repeat key to determine if any key is down.
2. Check the KEY UP H signal at pin 10 of E5. The signal should always be high unless a key is pressed.
3. Check each AC bit at the inputs to encoders E5 and E6. A switching signal should be observed.
4. Check the output pin of encoder E6. A switching signal should be observed.
5. Check the output of each OR gate while in turn pressing each key wired to that gate.

5.2.6 Communications Interface Troubleshooting

A faulty interface module will cause errors when transmitting and/or receiving codes to or from the host. However, the same symptoms may be produced by a faulty cable between the terminal and the host or by failing components in the host processor or the terminal itself. The following steps will help to localize the problem to the interface module or eliminate the interface as a possible cause of the problem.

1. Place the unit off-line (Paragraph 3.2.1) and type in some characters that have been failing. If the failing symptoms are still present, the fault is in the terminal. If the characters appear normal, the terminal can be eliminated as a possible cause of the problem. The fault lies with the interface module, the host, or the interconnecting cable. Go to step 2.
2. Replace the communications interface module and place the unit on-line (Paragraph 3.2.2). Type in some characters that have been failing. If the failing symptoms reappear, the host system is probably faulty and should be examined.

5.3 SUBASSEMBLY REPLACEMENT

This paragraph contains information pertaining to the removal and replacement of the electrical sub-assemblies of the VT62. Figure 5-18 lists all the removal procedures discussed in this paragraph and the sequence in which they are performed. As an example, Figure 5-18 illustrates that to remove the processor/video board, the memory and the terminal base removal procedures must be performed. Figure 5-19 shows the interrelationship of the memory board, the processor/video board, and the I/O board, as well as the placement of the various communications interface modules. Figures 5-20 through 5-41 illustrate the various procedures that follow.

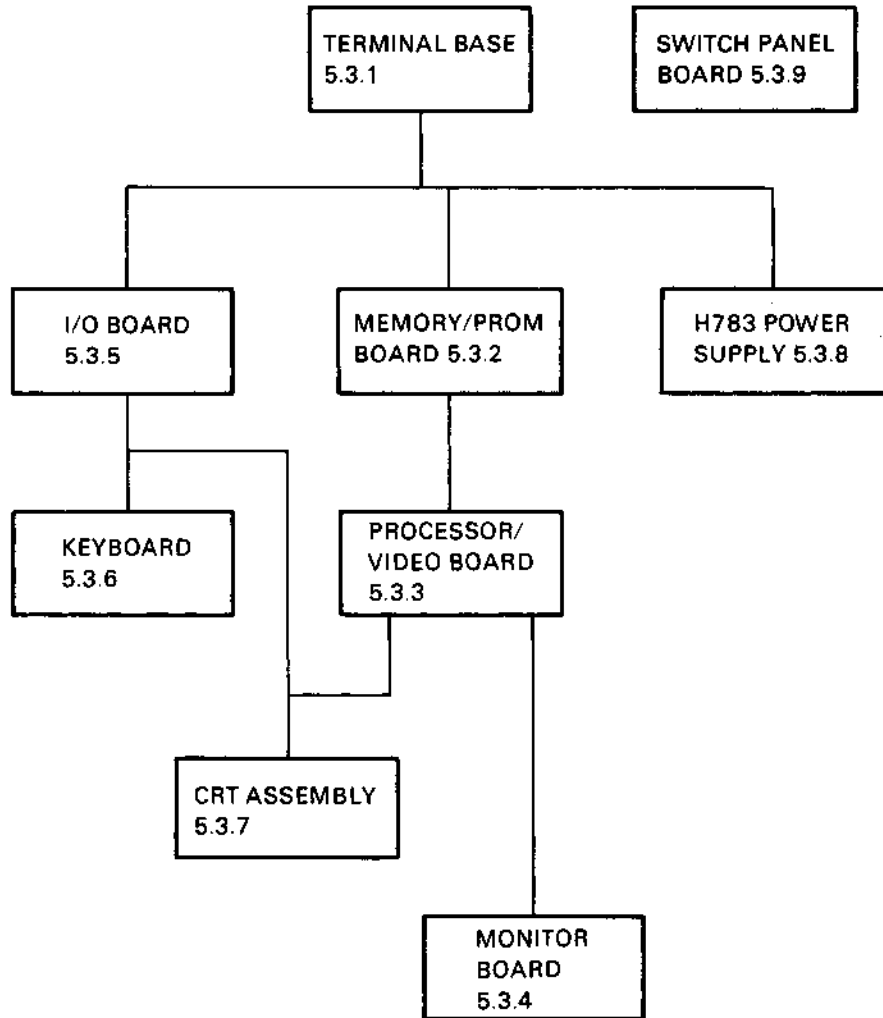

CP-2818

Figure 5-18 Module Removal Sequence

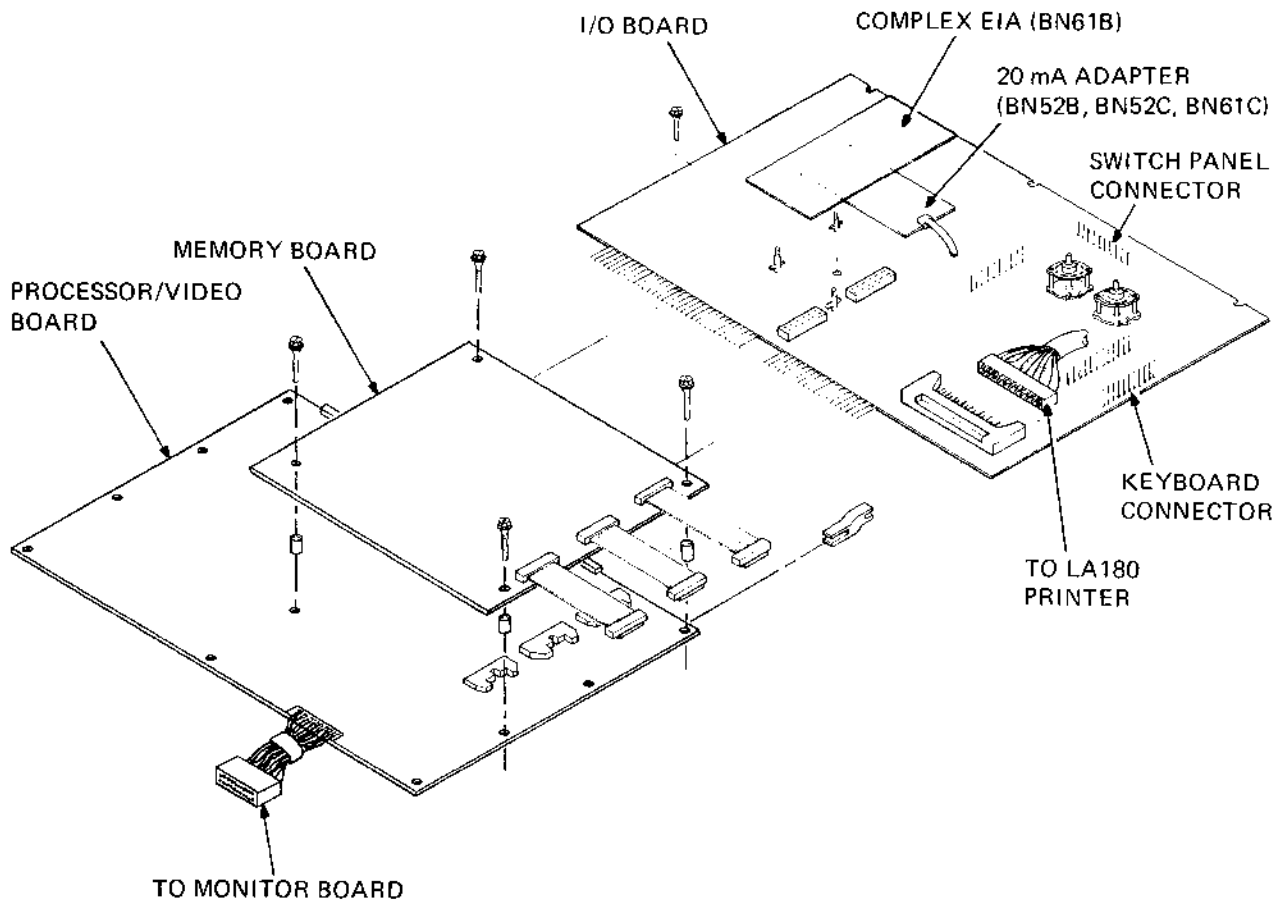

MA-0934

Figure 5-19 Terminal Logic Board Removal

5. Remove the switch panel board connector P1 from J4 on the I/O board (Figure 5-21).

CAUTION

Ensure that P1 is replaced correctly on J4, with the black wire of the cable toward the front of the unit. P1 incorrectly replaced on J4 will damage the I/O board upon power-up, necessitating its replacement.

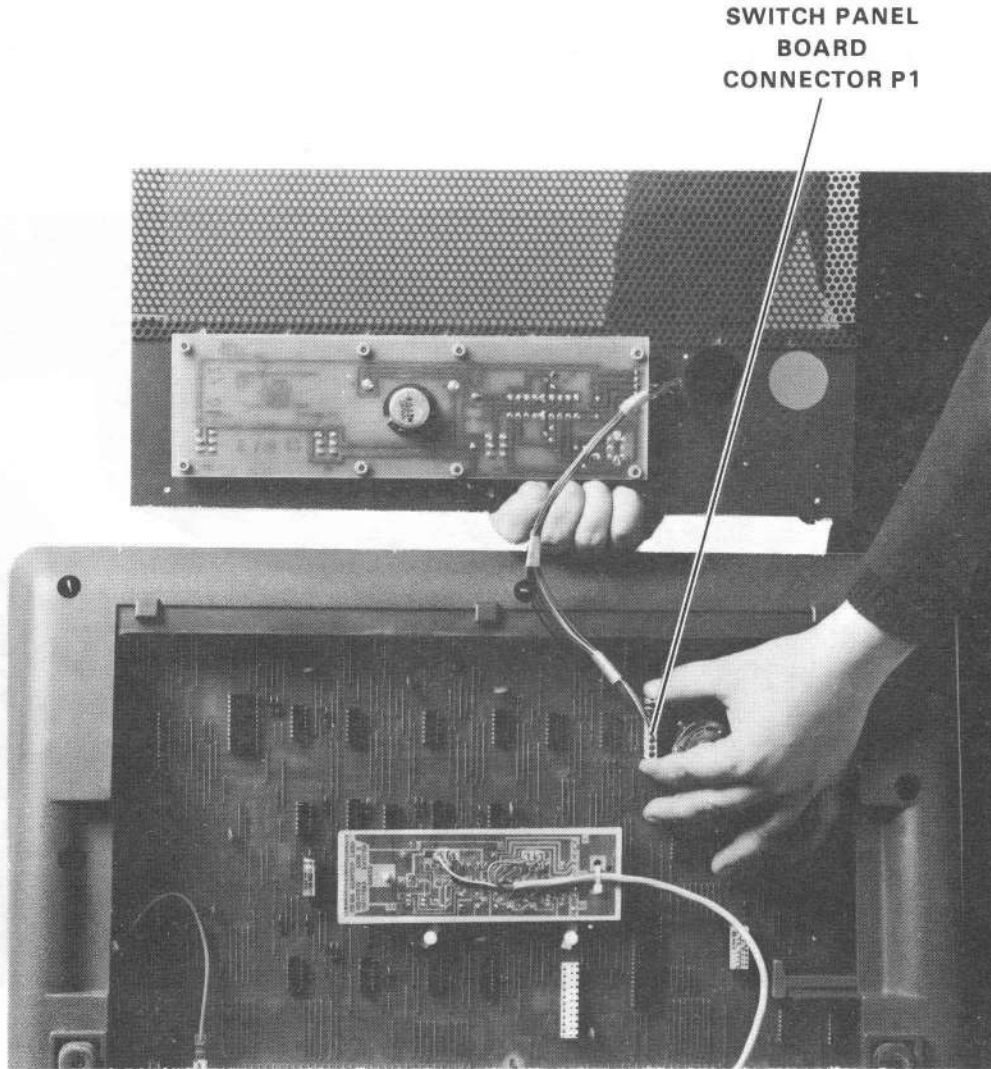

8284-14-A0008

Figure 5-21 Removing the Switch Panel Board Connector

6. Remove the communications option card from its socket on the I/O board. (See Figure 5-22 and Appendix B.)
7. Remove the hex-head screw (8-32 \times 3/8) located top left center on the louvered heat sink plate (using a 1/4 inch nut driver).
8. Remove the base assembly from the shell by first turning the 1/4-turn fasteners 90 degrees counterclockwise (five places). Notice that the five 1/4-turn fasteners are not removed, but merely turned (using a 1/4 inch nut driver) 90 degrees counterclockwise to loosen, and 90 degrees clockwise to tighten (Figure 5-23).
9. Reverse steps 1 through 8 to reassemble.

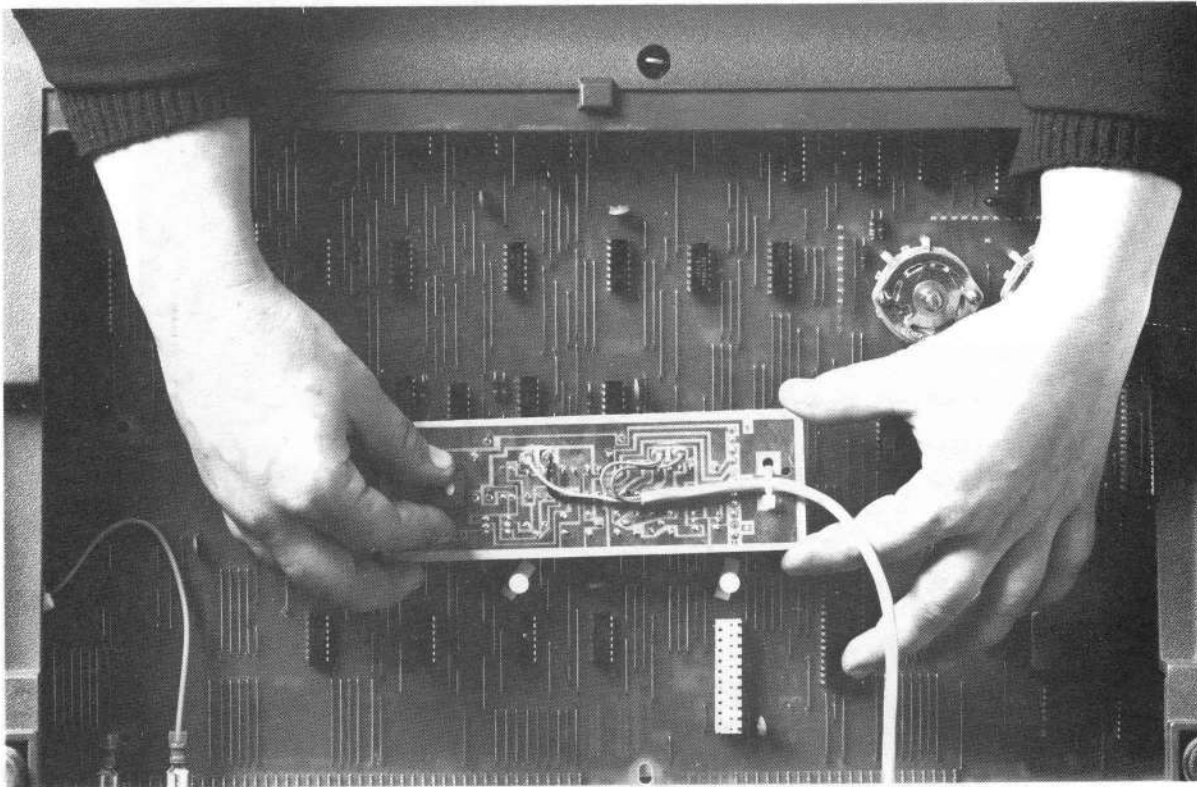

8284-20-A0025

Figure 5-22 Removing the 20 mA Communications Option Card



8284-26

Figure 5-23 Removing the Base Assembly from the Shell

5.3.2 Replacing the Memory Board

To replace this board, refer to Figures 5-24 and 5-25, unit assembly drawing 0-UA-VT62-0-0, and perform the following steps.

1. Remove the base assembly from the shell (Paragraph 5.3.1).
2. Remove the four visible hex-head screws (No. 8-15 \times 1-3/8 lg) on the memory board (using a 1/4 inch nut driver) (Figure 5-24).

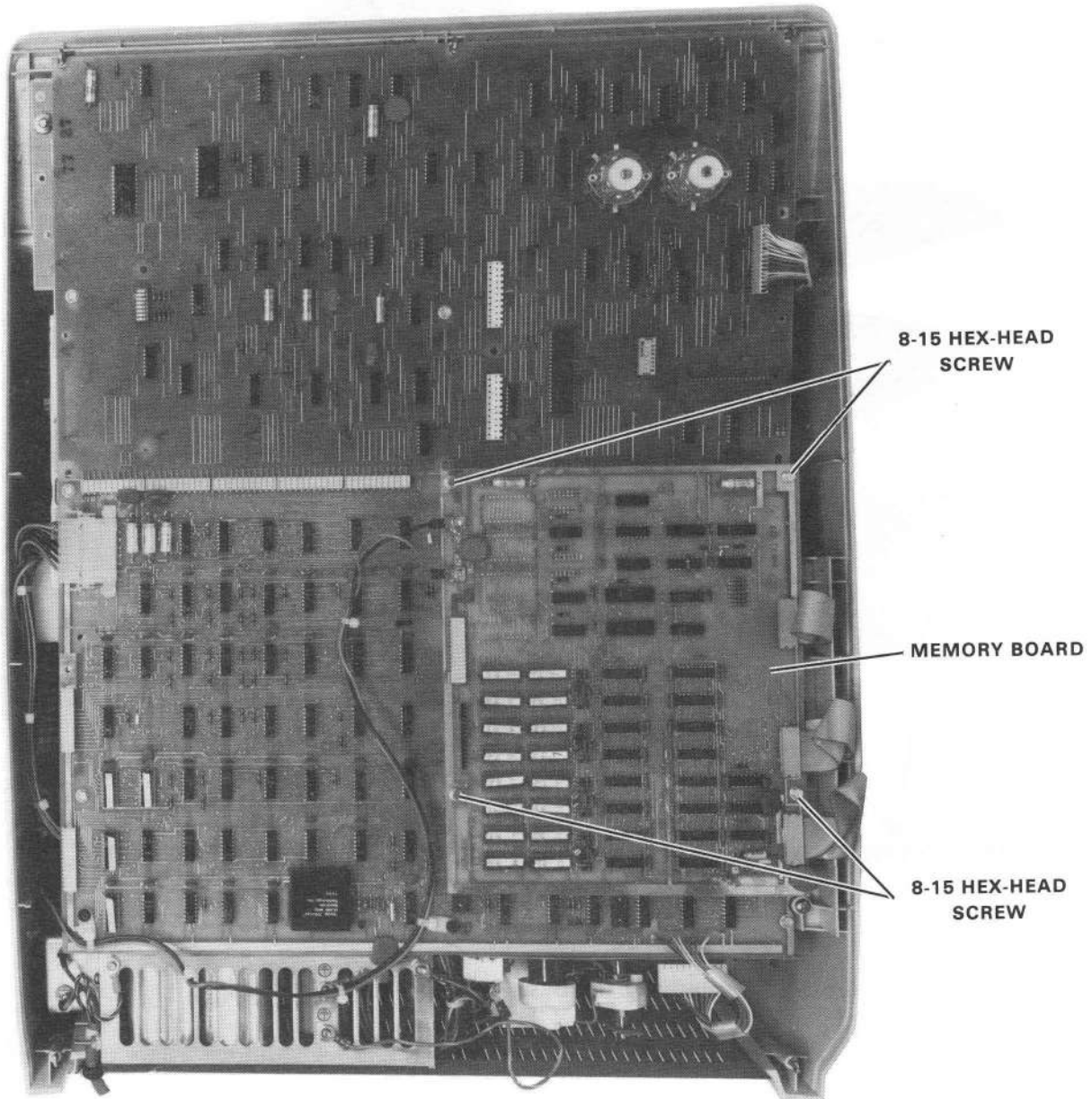

8595-3-A0012

Figure 5-24 VT62 Terminal, Bottom View,
Base and Louver Plate Removed

3. Disconnect the +5 V and ground wires (red wire is +5 V wire) from the memory board (Figure 5-25).
4. Disconnect J2, J3, and J4 (Berg connectors) from the processor/video board and remove the memory board (Figure 5-26).
5. Reverse steps 1 through 5 to reassemble.

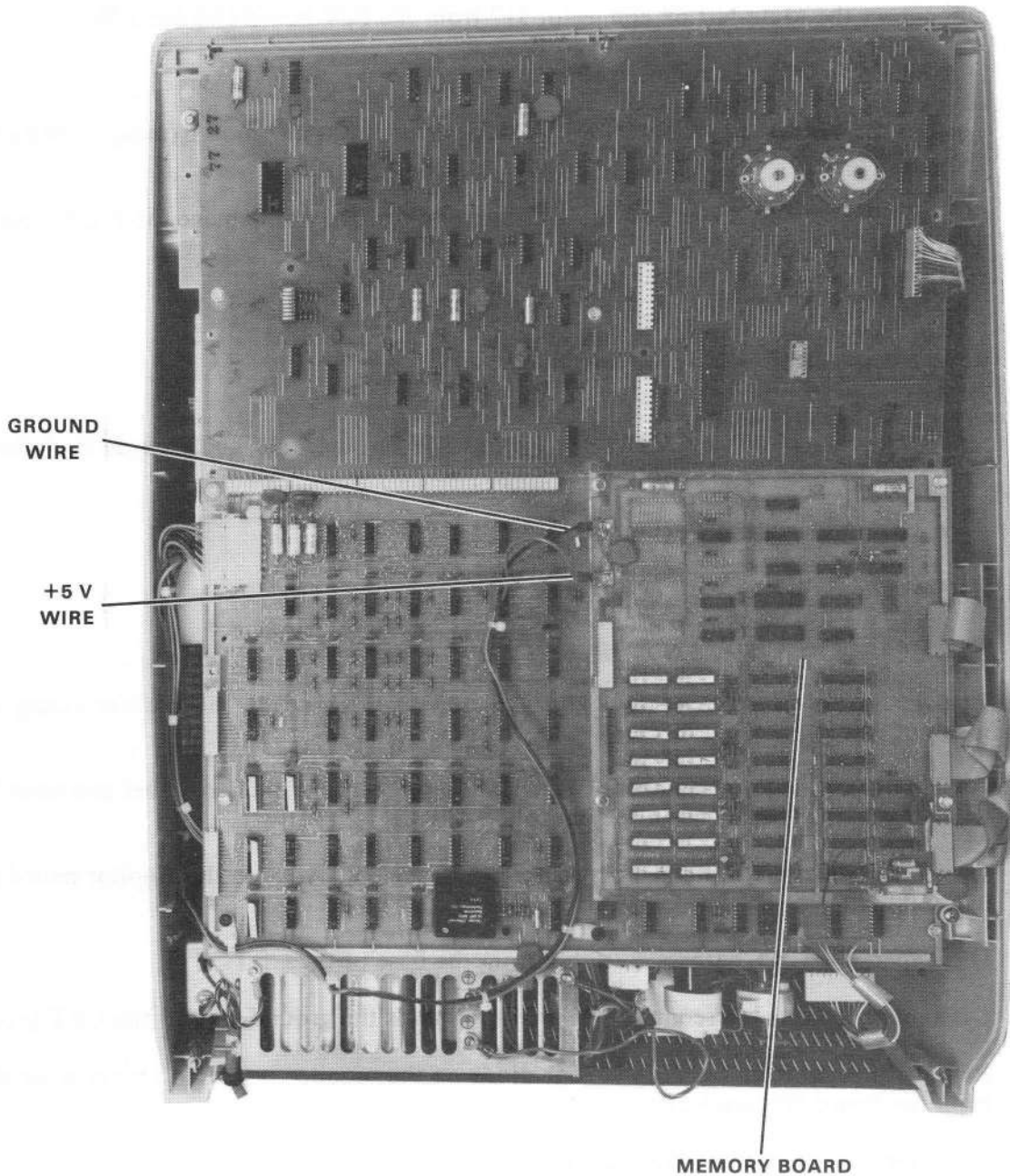

8595-3-A0011

Figure 5-25 Memory Board Removal

5.3.3 Replacing the Processor/Video (P/V) Board

To replace the P/V board, refer to Figures 5-26 and 5-27, unit assembly drawing 0-UA-VT62-0-0, and perform the following steps.

1. Remove the base assembly from the shell (Paragraph 5.3.1).
2. Remove the memory board (Paragraph 5.3.2).
3. Disconnect the Mate-N-Lok connector J17 from the P/V board (Figure 5-26).
4. Disconnect J1 (at video monitor board).
5. Remove the 4 hex-head screws (No. 10 × 0.38) securing the P/V board (using a 1/4 inch nut driver).
6. Gently pull the P/V board and the I/O board apart. Do not damage the I/O board connector pins (Figure 5-27).
7. Remove the P/V board.
8. Reverse steps 1 through 8 to reassemble.

5.3.4 Replacing the Monitor Board

Refer to unit assembly drawing 0-UA-VT62-0-0, Figures 5-28 through 5-30, and perform the following steps.

1. Remove the base assembly (Paragraph 5.3.1).
2. Remove the memory board (Paragraph 5.3.2).
3. Remove the P/V board (Paragraph 5.3.3).
4. Remove the hex-head screws (8-32 × 3/8 lg) holding the louvered backplate on (using a 1/4 inch nut driver).
5. While holding the louvered backplate, slide the power cable and its rubber grommet from the slot provided for them on the backplate (Figure 5-28).
6. Disconnect the 6-pin Mate-N-Lok that connects the CRT yoke to the monitor board (Figure 5-29).
7. Disconnect the CRT harness assembly from the base of the CRT.
8. Disconnect the quick-disconnect terminal that holds the ground wire to the CRT ground.
9. Remove the cap from the high-voltage diode on the monitor board and remove the diode from the board (Figure 5-30).
10. Disconnect J2 on the monitor board.
11. Remove the monitor board by removing the hex-head screw (8-15 × 0.38) and the three plastic locking posts (squeeze the tabs on each post while applying slight outward pressure on the board).
12. Reverse steps 1 through 10 to reassemble.

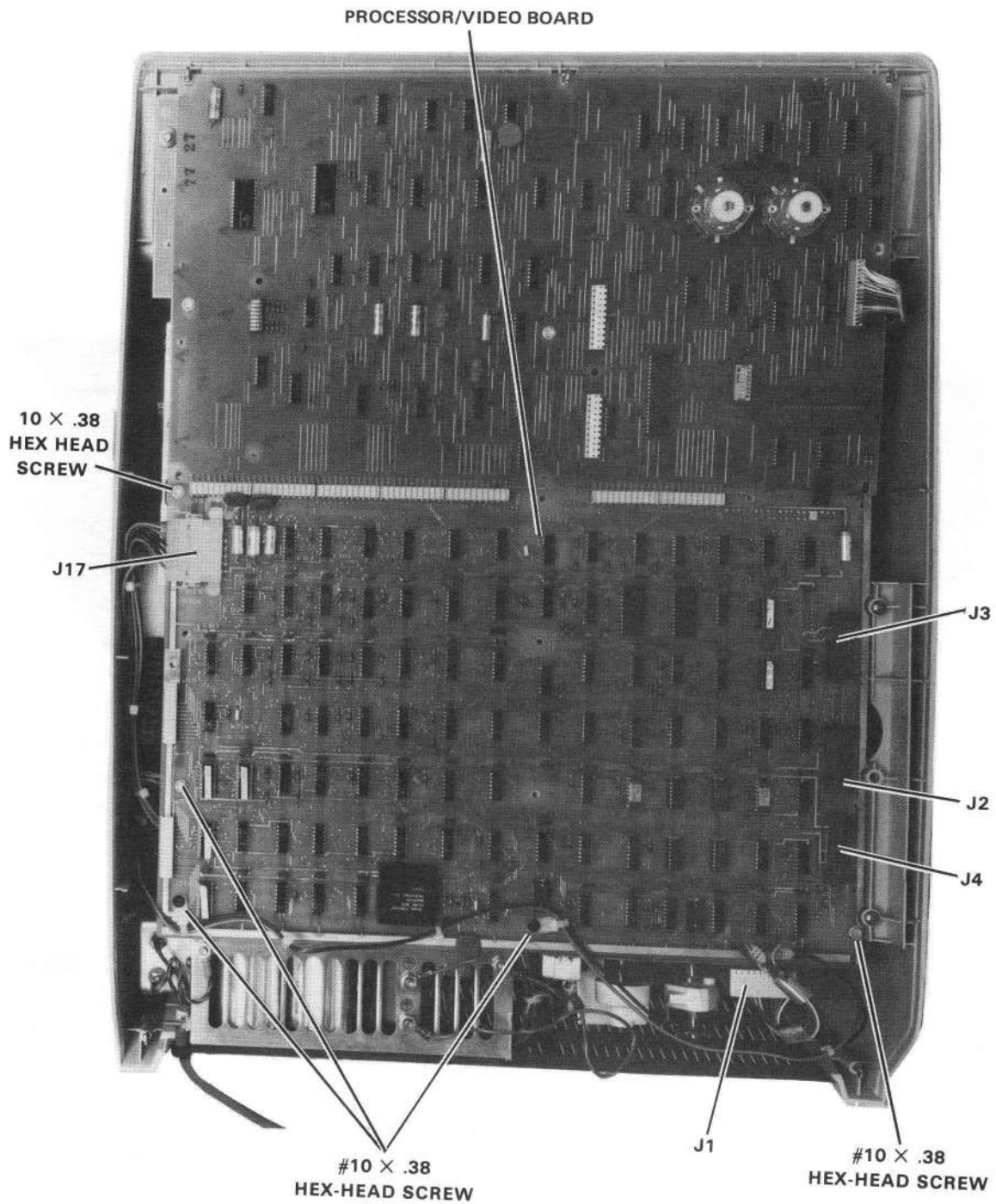

8595-4-A0016

Figure 5-26 VT62 Terminal, Bottom View, Base,
Louver Plate, and Memory Board Removed

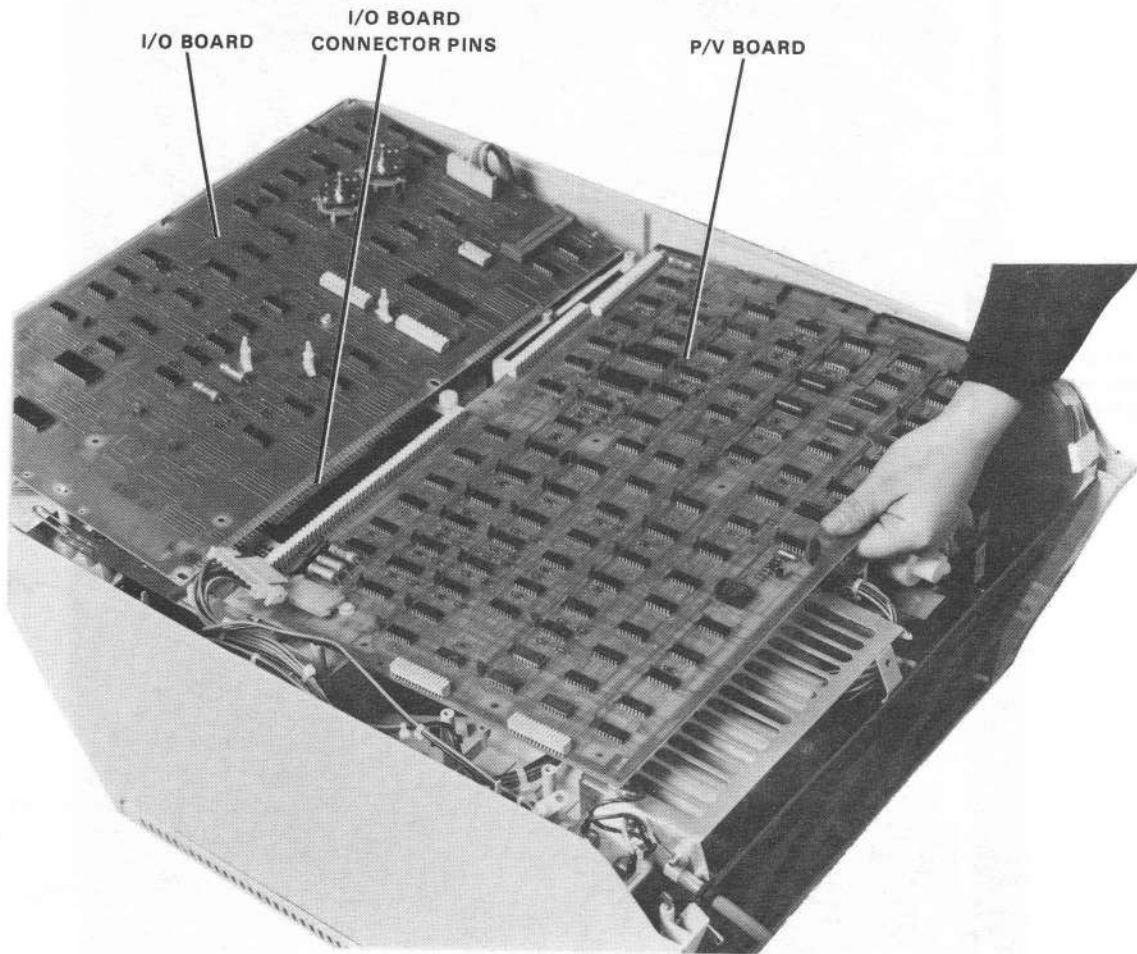

8284-19

Figure 5-27 Processor/Video Board Removal

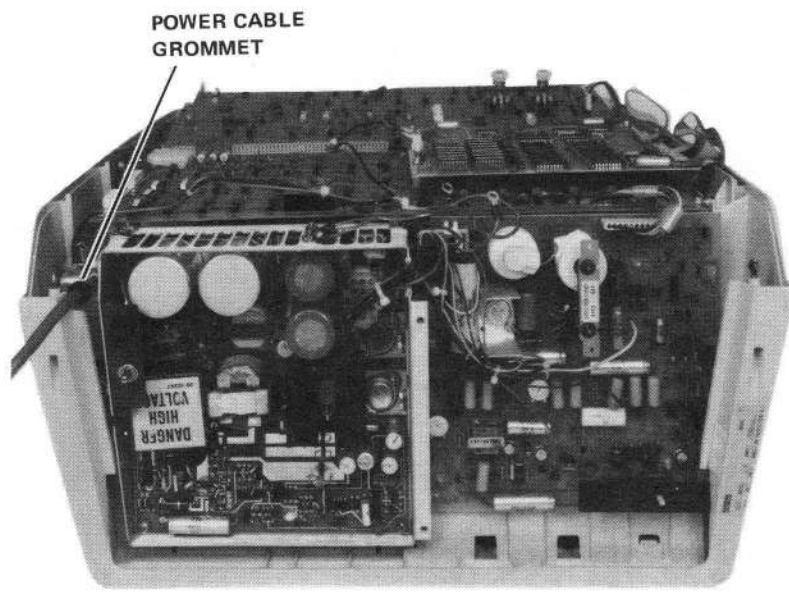

8595-8-A0023

Figure 5-28 Louver Plate Removal

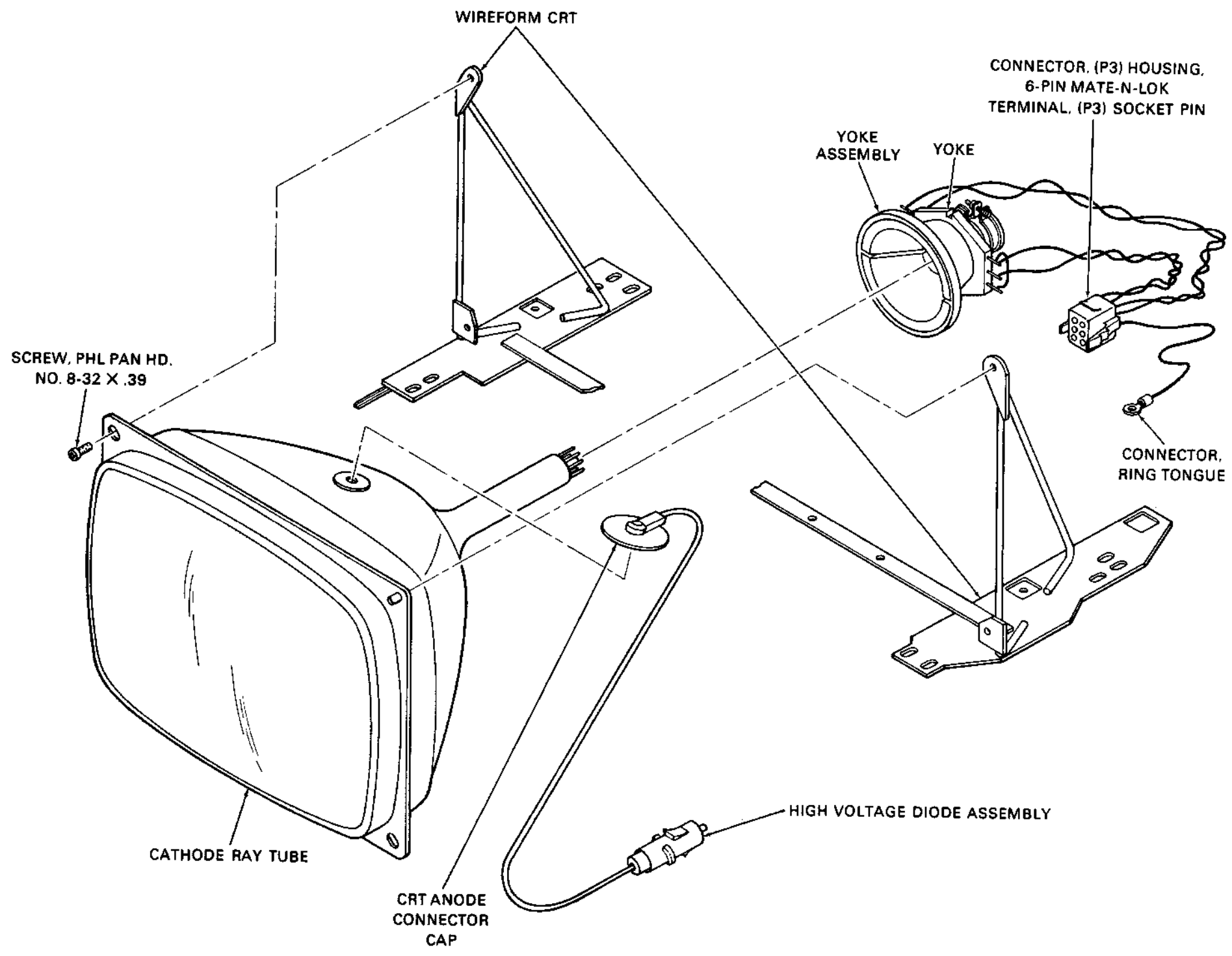

CP-2823

Figure 5-29 CRT Assembly

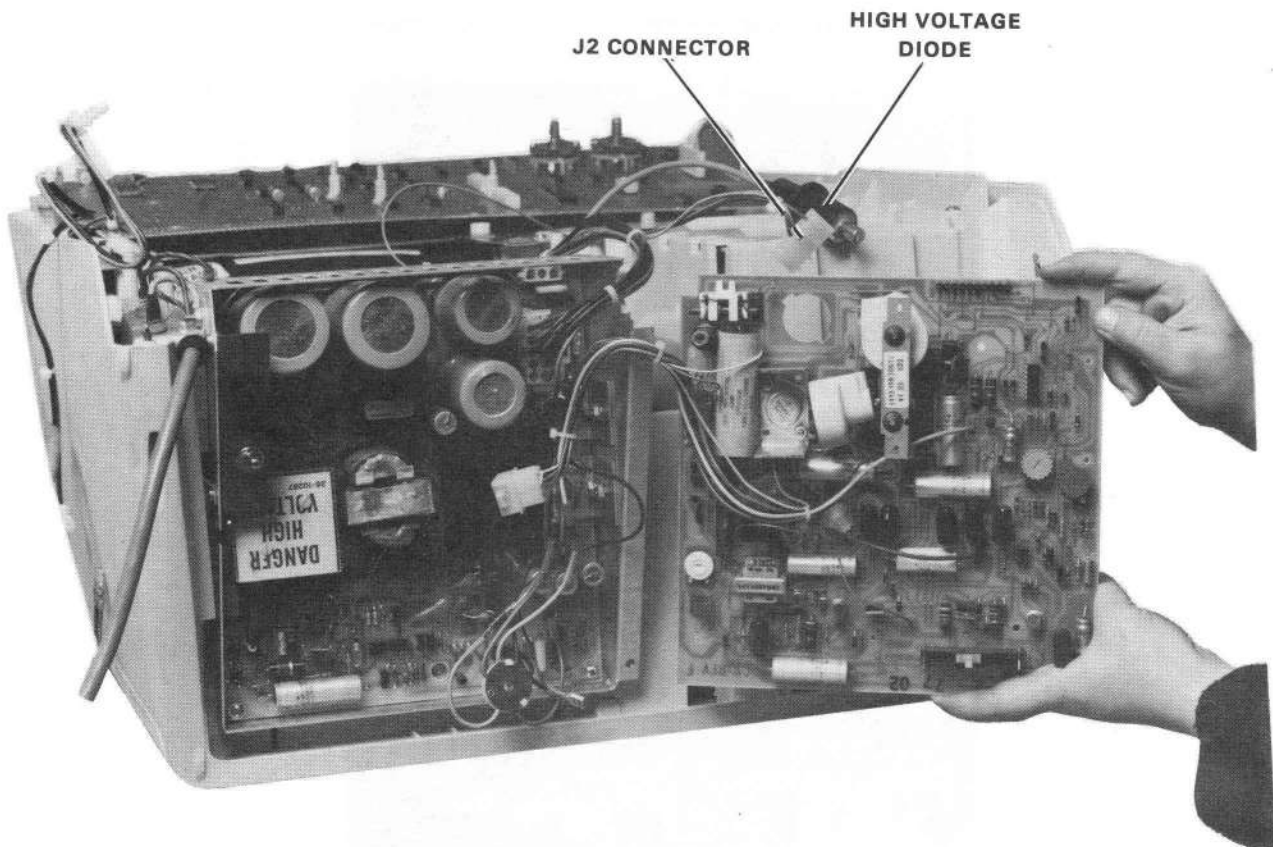
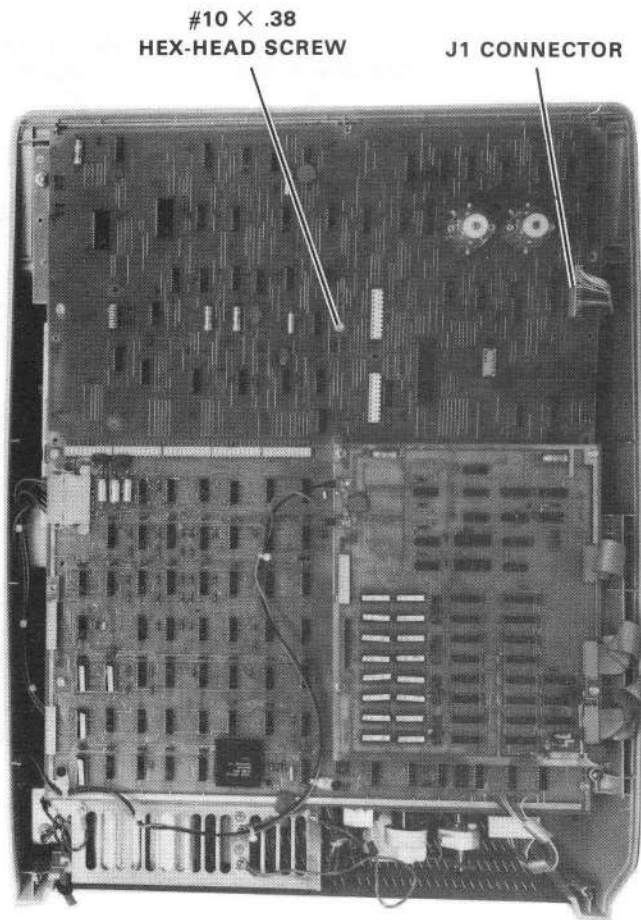

Figure 5-30 Monitor Board Removal

5.3.5 Replacing the I/O Board

Refer to unit assembly drawing 0-UA-VT62-0-0, Figure 5-31, and perform the following steps.

1. Remove the base assembly (Paragraph 5.3.1).
2. Disconnect J1 from the I/O board (Figure 5-31).
3. Remove the single hex-head screw from center of I/O board (using a 1/4 inch nut driver).
4. Gently pull the I/O board and the P/V board apart. Do not damage the I/O board connector pins.
5. Remove the I/O board from the unit.
6. Reverse steps 1 through 5 to reassemble.



8595-3-A0010

Figure 5-31 VT62 Terminal, Bottom View,
Base and Louver Plate Removed

5.3.6 Replacing the Keyboard

Refer to unit assembly drawing 0-UA-VT62-0-0, Figure 5-32, and perform the following steps.

1. Remove the base assembly (Paragraph 5.3.1).
2. Remove the I/O board (Paragraph 5.3.5).
3. Remove the six hold-down screws from the keyboard module (Figure 5-32). As the figure shows, four of the screws (No. 10 X 0.38) are removed with a 1/4 inch nut driver; the other two screws (self-tap, No. 4) require a blade (common) screwdriver.
4. Lift the keyboard from the unit.
5. Reverse steps 1 through 4 to reassemble.

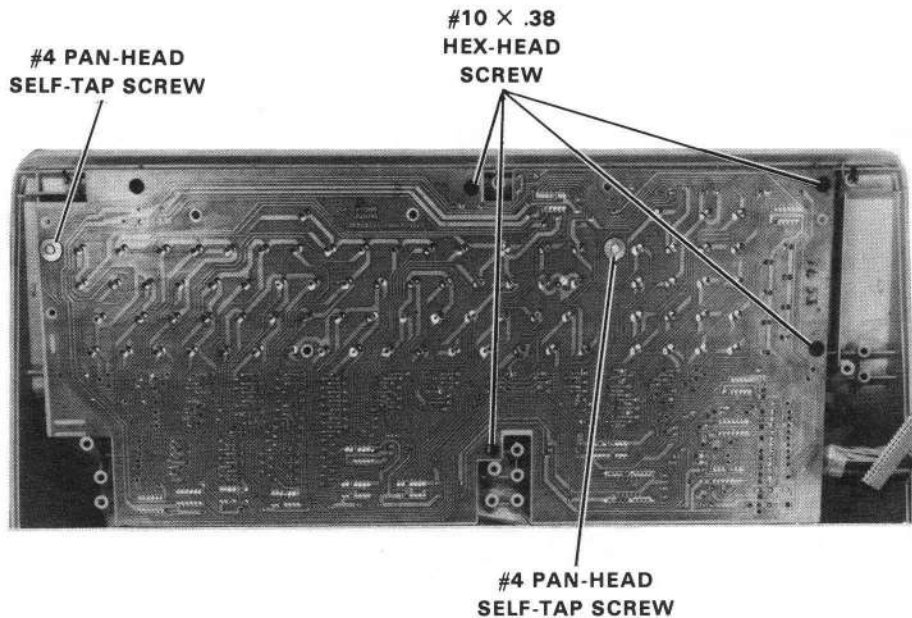

8284-1

Figure 5-32 VT62 Terminal, Bottom View (Partial),
Keyboard Module

5.3.7 Removing the CRT Assembly

Refer to unit assembly drawing 0-UA-VT62-0-0, Figures 5-33 through 5-36, and perform the following steps.

1. Remove the base assembly (Paragraph 5.3.1).
2. Remove the memory board (Paragraph 5.3.2).
3. Remove the P/V board (Paragraph 5.3.3).
4. Remove the I/O board (Paragraph 5.3.5).
5. Disconnect the 6-pin Mate-N-Lok that connects the CRT yoke to the monitor board (Figure 5-33).
6. Disconnect the socket of the CRT harness assembly from the base of the CRT.
7. Remove the cap from the high voltage diode on the monitor board and remove the diode from the board (Figure 5-34).
8. Disconnect the ground wire in the CRT harness assembly from the CRT wire form.

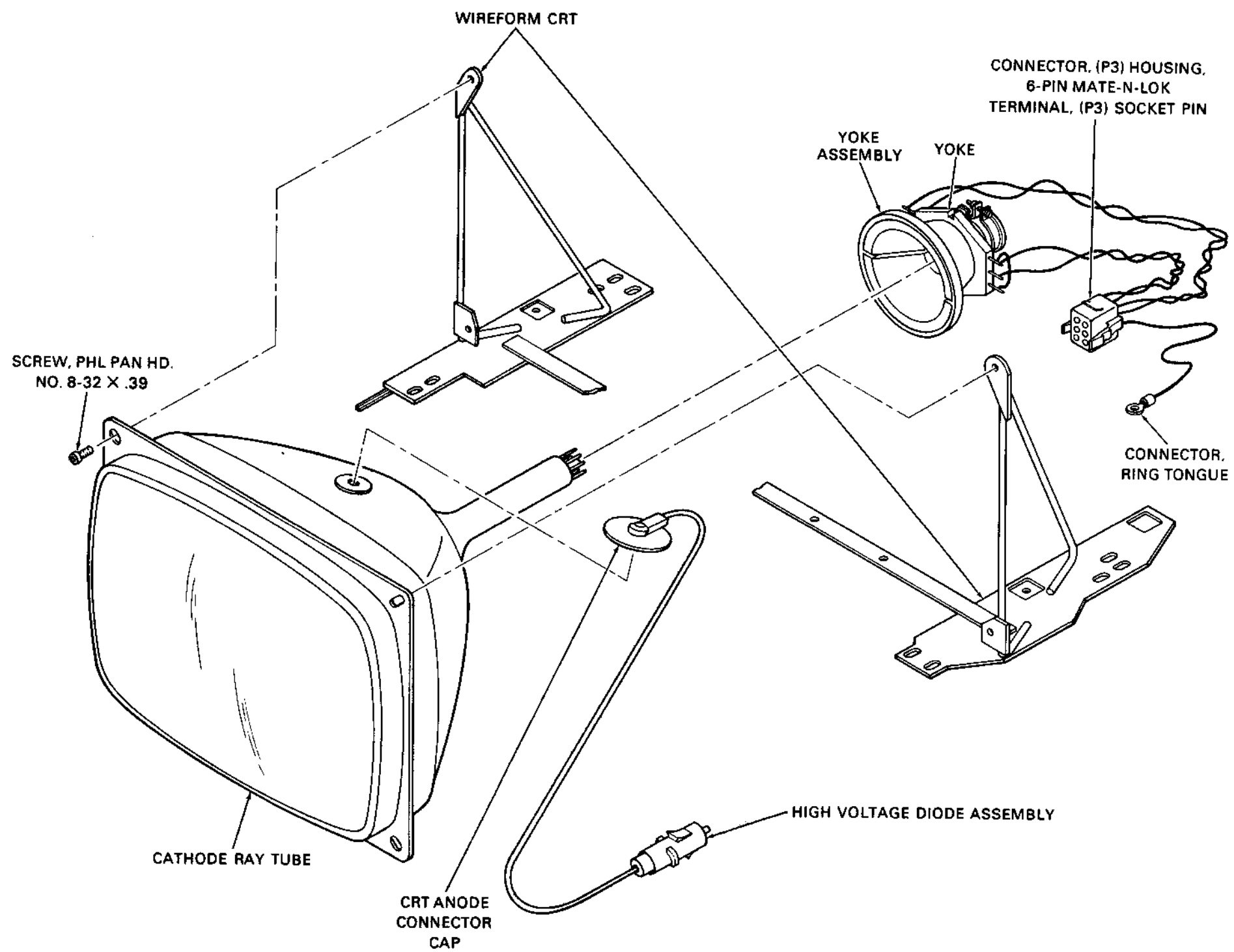

CP-2823

Figure 5-33 CRT Assembly

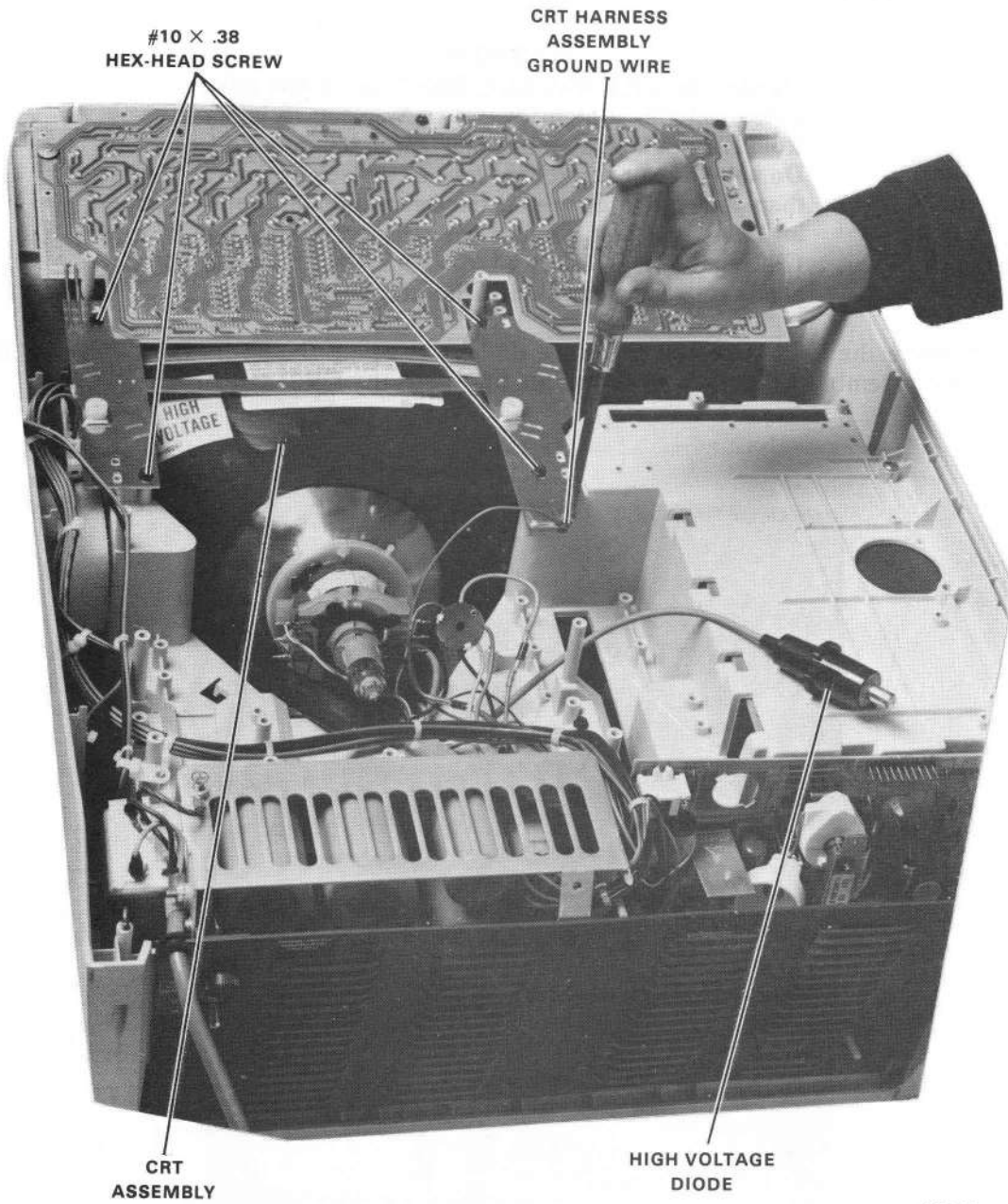

8284-15

Figure 5-34 CRT Assembly Removal Preparation

9. Remove the four hex-head screws (No. 10 × 0.38) holding the CRT wire form, using a 1/4 inch nut driver.

WARNING

Handle the CRT with care. Breakage of this tube, which contains a high vacuum, may result in injury from flying glass. Remove tube carefully from unit. Do not strike or scratch the tube or subject it to more than moderate pressure when inserting into or removing from the unit. Remember when removing the CRT that it is in effect a large capacitor; the CRT anode connector has a potential of 10,000 V.

10. Remove the CRT assembly from the unit by grasping the CRT wire form and lifting the CRT assembly. (Figure 5-35 shows the unit with the CRT assembly removed.)

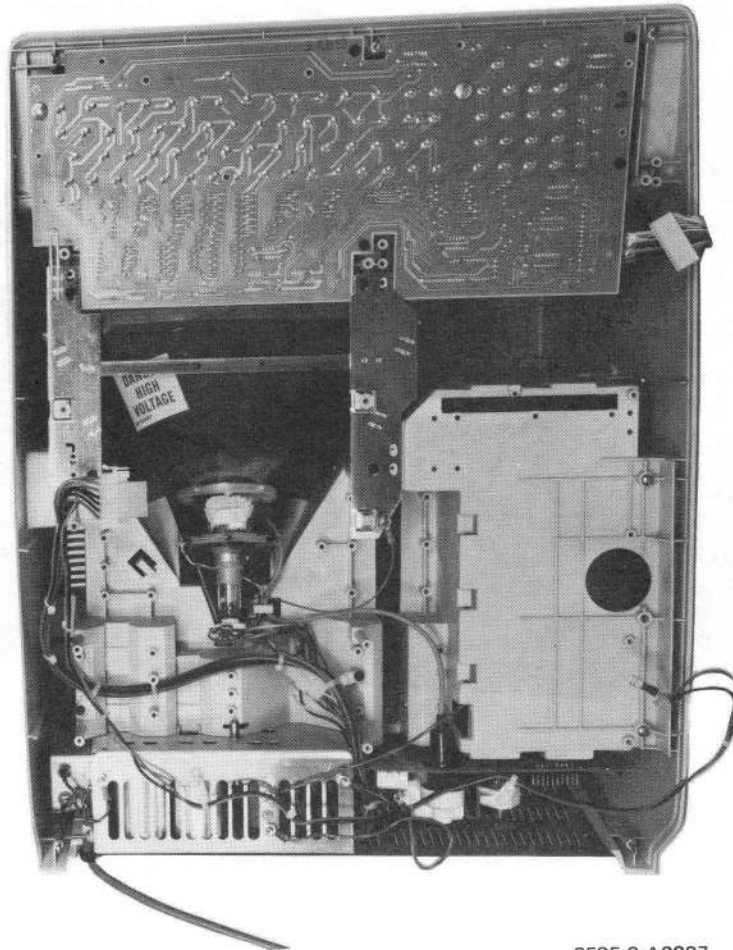

8595-2-A0027

Figure 5-35 VT62 Terminal, Bottom View, CRT Assembly Removal

11. Place the CRT assembly (and its wireform) face down on a soft clean surface (Figure 5-36).
12. Discharge the CRT high-voltage anode by sliding a grounded probe under the CRT anode connector cap.
13. Remove the high voltage diode assembly from the CRT (Figure 5-33).
14. Remove the four Phillips-head screws (No. 8-32 \times 0.39), holding the CRT wireform to the CRT.
15. Remove the CRT wireform.
16. Reverse steps 1 through 15 to reassemble. Omit the steps that are not applicable.

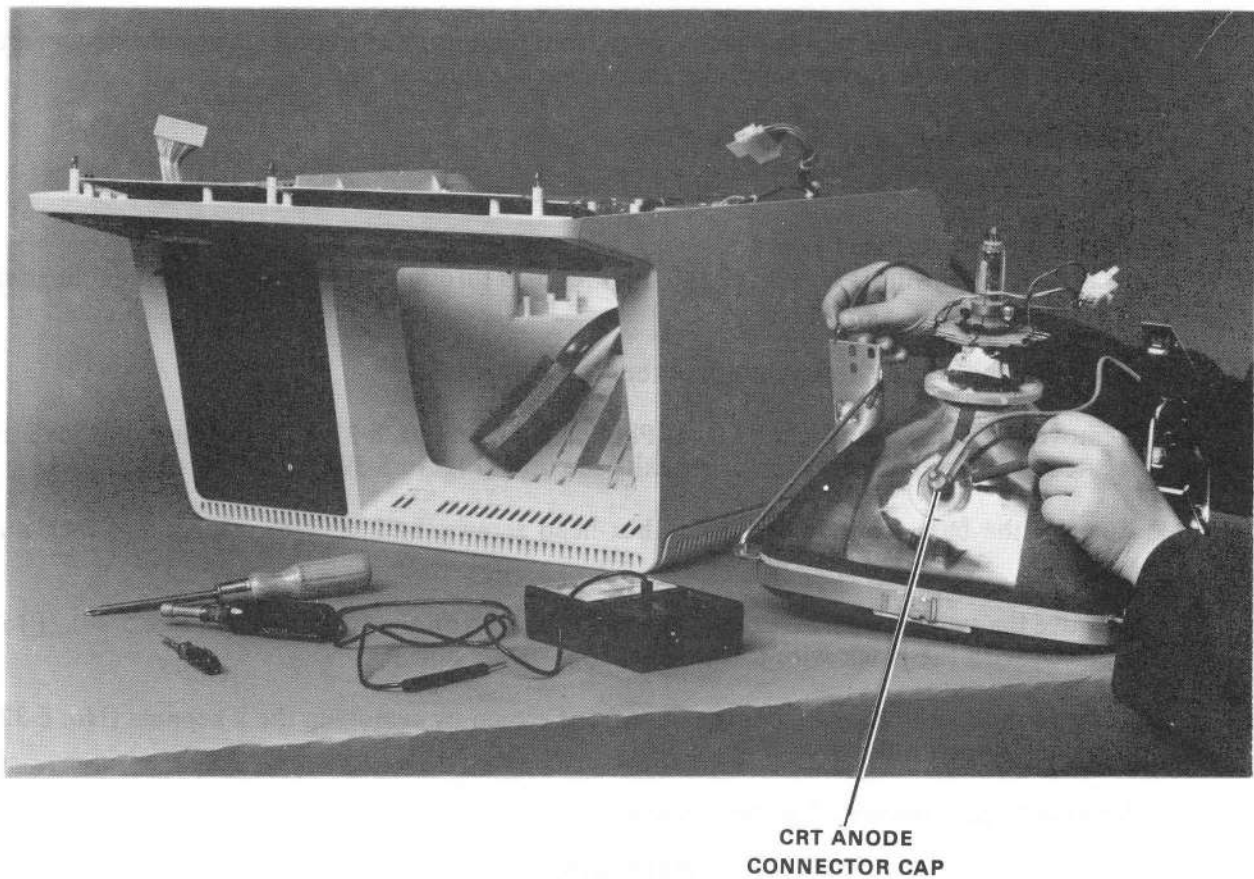

8284-27

Figure 5-36 Discharging the CRT High-Voltage Anode

5.3.8 Replacing the H7832 Power Supply

Refer to unit assembly drawing 0-UA-VT62-0-0, Figures 5-39 and 5-40, and perform the following steps:

1. Remove the base assembly (Paragraph 5.3.1).
2. Remove the hex-head screws (8-32 × 3/8 lg) that hold the louvered backplate (using a 1/4 inch nut driver).
3. While holding the louvered backplate, slide the power cable and its rubber grommet from the slot provided for it on the backplate (Figure 5-37).
4. Detach the ground strap between the power supply and the louvered backplate.
5. Loosen the slotted-head fastener (Figure 5-38) until the top of the power supply chassis can be pulled away from the unit.
6. Gently pull the power supply chassis away from the unit, while applying a slight downward pressure to free the power supply chassis tabs engaging the unit.
7. Reverse steps 1 through 6 to reassemble.

5.3.9 Replacing the Switch Panel Board

Refer to unit assembly drawing 0-UA-VT62-0-0, Figures 5-39 through 5-41, and perform the following steps.

1. Place the unit upside down on a workbench or a table.
2. Remove the plastic cable clamp (two Phillips head screws, 8-32 × 3/8). The cable cover is located at the point where the cable exits the unit (Figure 5-39).
3. Remove the base front screen (three hex-head screws, 8-32 × 3/8) using a 1/4 inch nut driver.
4. Remove the switch panel board connector P1 from J4 on the I/O board (Figure 5-40). (P1 is replaced with the black wire toward the front of the unit.)
5. Remove the switch board from the base front screen by removing the 8 kepnuts (No. 6-32) using a 1/4 inch nut driver (Figure 5-41).
6. Reverse steps 1 through 4 to reassemble.

CAUTION

Ensure that P1 is replaced correctly on J4, with the black wire of the cable toward the front of the unit. P1 incorrectly replaced on J4 will damage the I/O board upon power-up, necessitating its replacement.

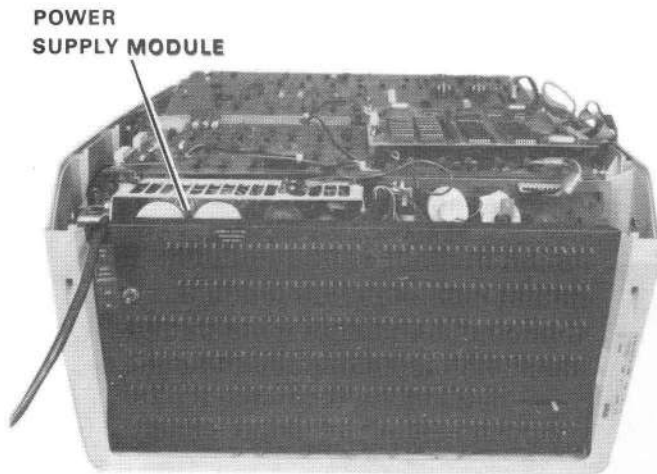

8595-8-A0024

Figure 5-37 Louver Plate Removal

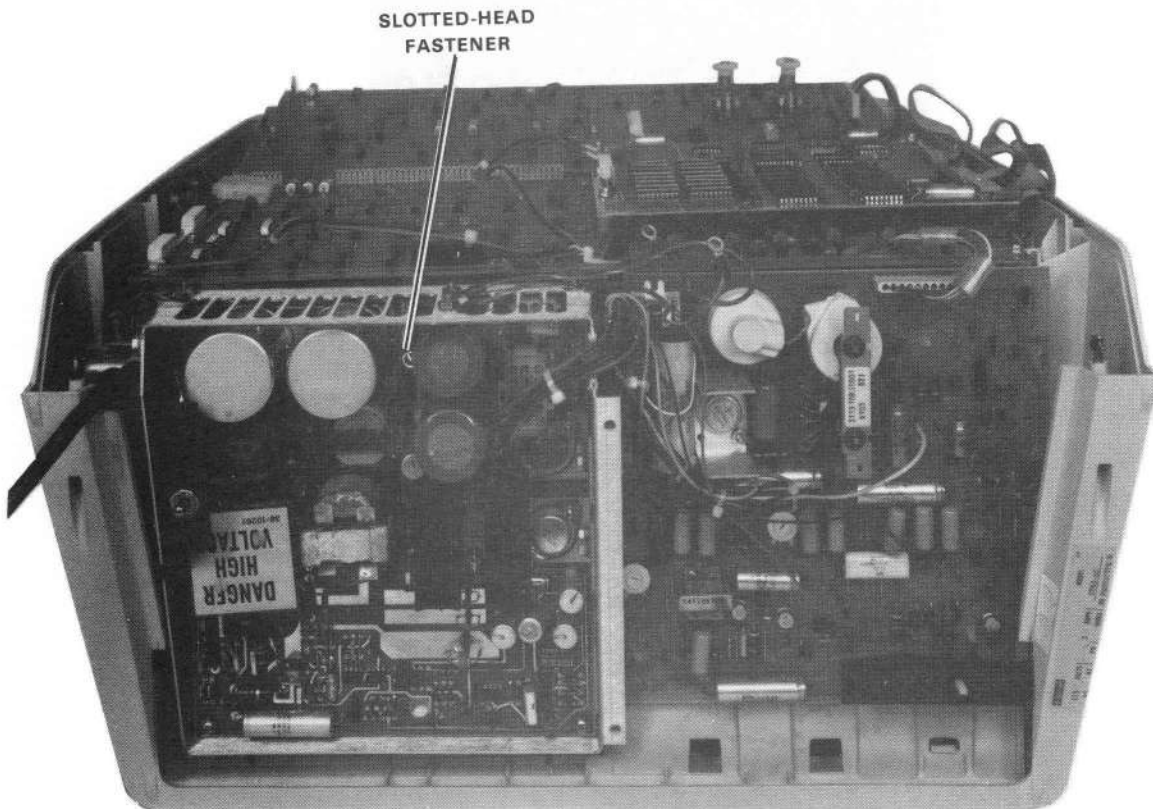

8595-11-A0022

Figure 5-38 VT62 Terminal, Rear View (Upside Down),
Louver Plate Removed

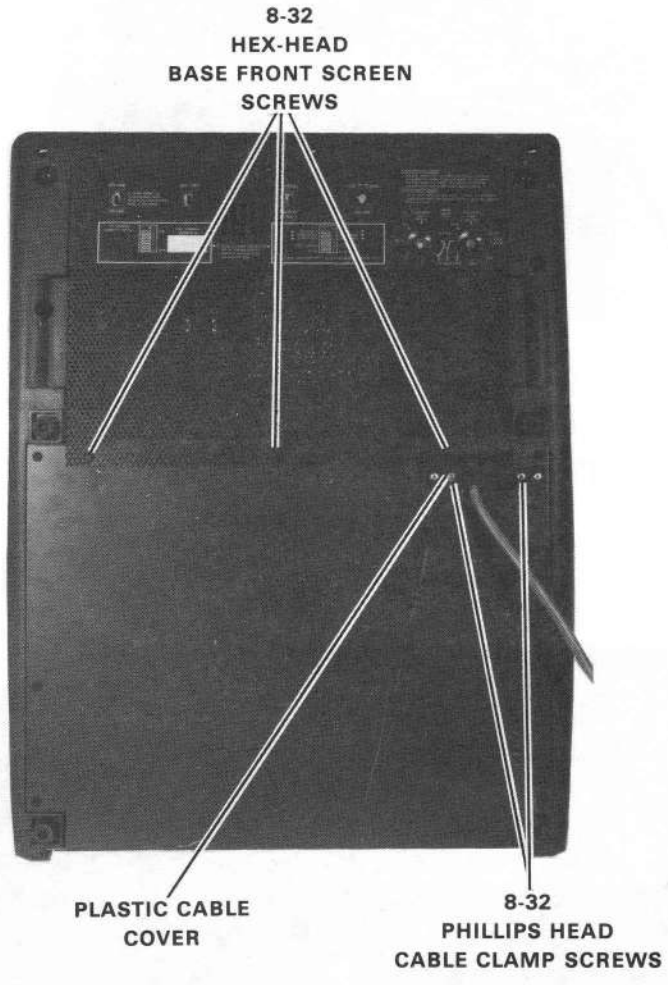

8595-9-A0002

Figure 5-39 VT62 Terminal, Bottom View,
Base Front Screen Installed

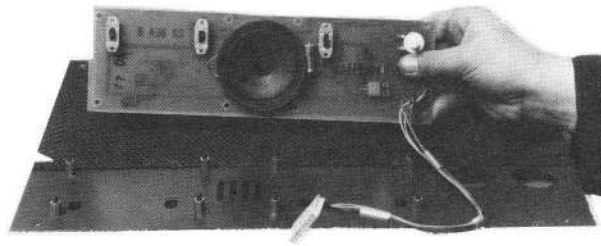

8284-21

Figure 5-40 VT62 Terminal, Bottom View (Partial),
Base Front Screen Removed

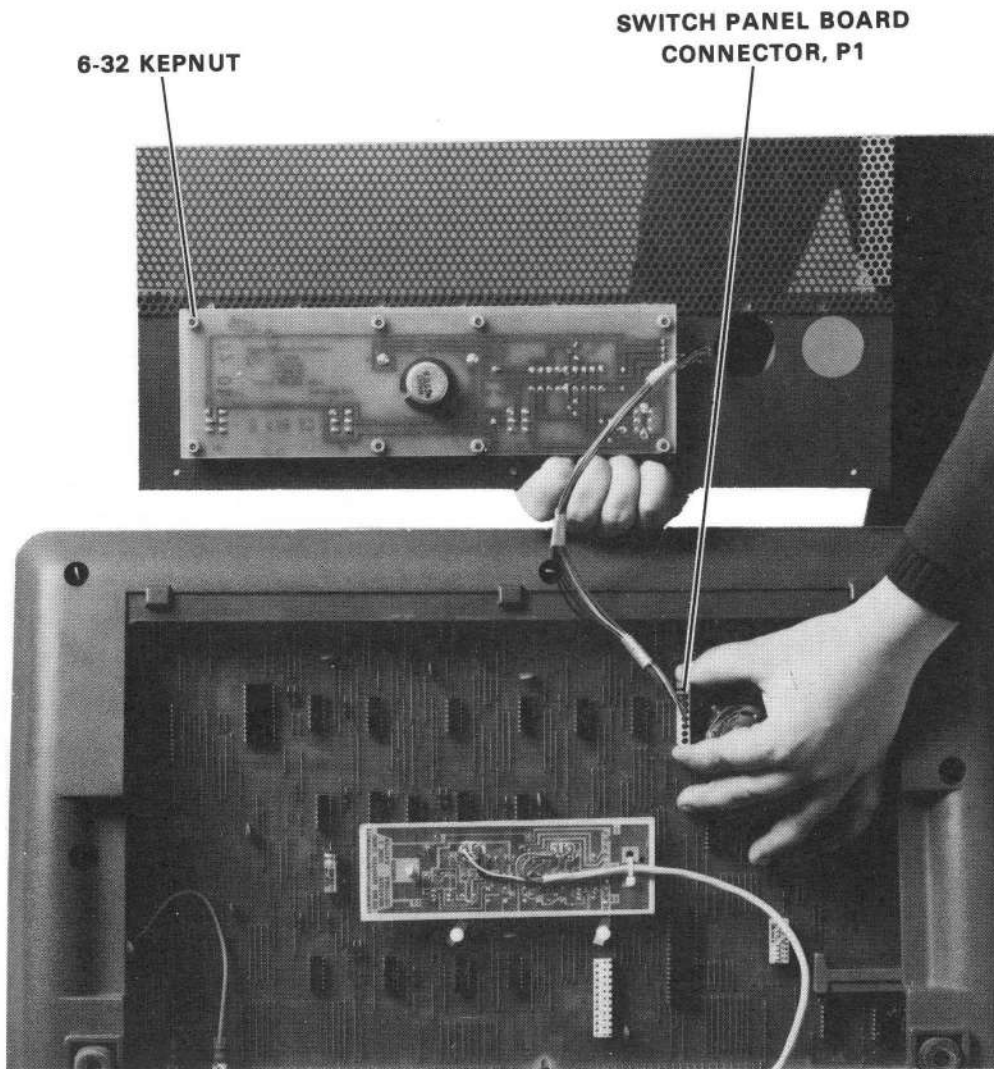

8284-14-A0006

Figure 5-41 Switch Board Removal

CHAPTER 6 DISPLAY ADJUSTMENTS

6.1 GENERAL

Normally, except for the intensity level, no adjustments are required to the terminal after the initial manufacturing checkout and alignment of the unit. However, after replacing a CRT or a deflection yoke, the display must be realigned and adjusted. All adjustments are located on the monitor board. Set the unit to off-line operation and fill the screen with characters before making any adjustments. Refer to Figure 6-1 for locations of the adjusting coil and potentiometers.

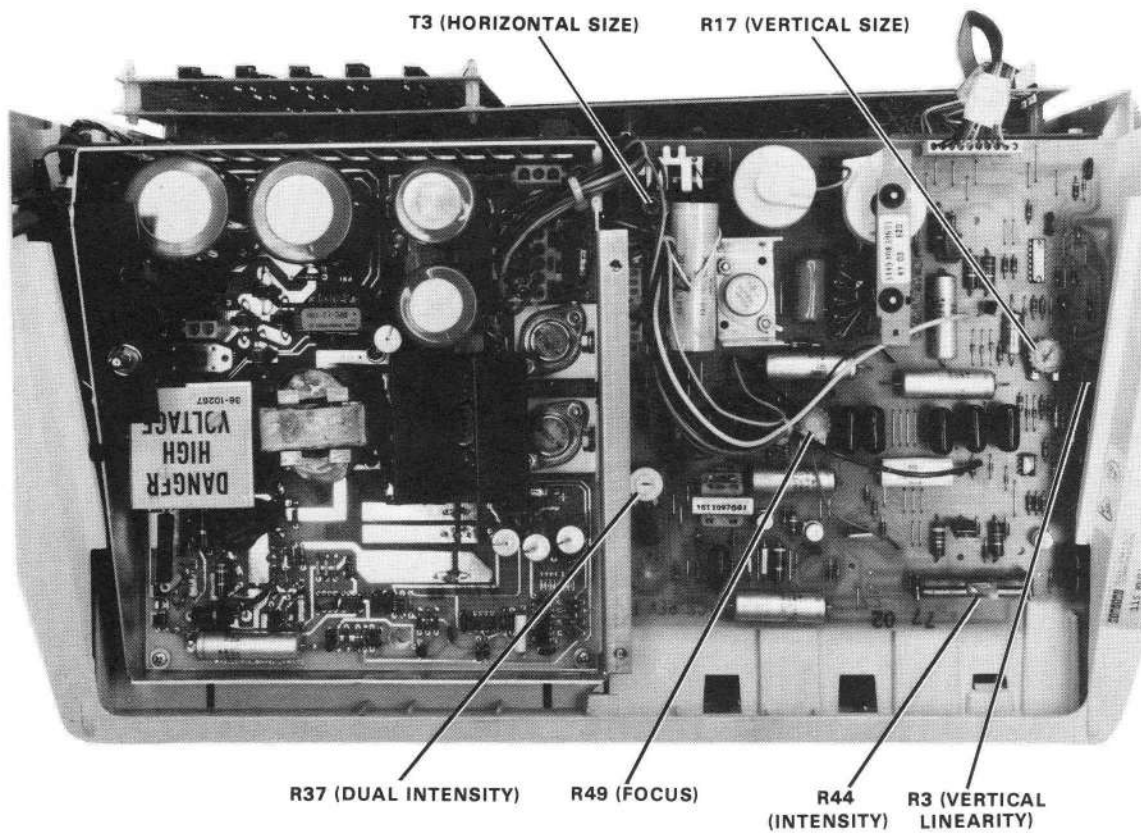

8284-8

Figure 6-1 Monitor Board Display Adjustments

6.2 HEIGHT ADJUSTMENT

Adjust the V-size potentiometer (R17) until the height of the display is 114 mm (4.5 inches). This measurement is from the upper edge of the top character line to the lower edge of the bottom character line.

6.3 WIDTH ADJUSTMENT

Using a non-conductive hexagonal-tipped alignment tool, adjust the iron slug in coil T3 until the width of the display measures 218 mm (8.6 inches).

6.4 VERTICAL LINEARITY ADJUSTMENT

Adjust the vertical linearity potentiometer (R3) until the characters displayed on the top line are the same size as the characters displayed on the bottom line.

6.5 FOCUS ADJUSTMENT

Adjust the focus potentiometer (R49) until characters in all sections of the screen are sharp and clear.

6.6 DUAL INTENSITY ADJUSTMENT

Adjust the dual intensity potentiometer (R37) so that both normal and reverse video disappear simultaneously as the intensity is lowered.

APPENDIX A ENGINEERING SPECIFICATIONS

A.1 VT62 ENGINEERING SPECIFICATIONS

A.1.1 General

This appendix specifies the level of performance the end user can expect from the VT62.

The VT62 is an upper- and lowercase ASCII video terminal whose display holds 24 lines of 80 characters each. Its important features are:

- Multipoint DDCMP block oriented communications (asynchronous and synchronous)
- Formatted "protected form" display for operator entry
- Local input checking for and correction of many operator errors
- DIGITAL standard typing keyboard augmented by specific functions for operator convenience.

A.1.2 Hardware Design

The VT62 utilizes a microprocessor rather than discrete logic alone to perform its functions. There are three categories of memory used in the microprocessor, not counting read only memories (ROMs) used to generate characters and perform other simple conversions. These three types are discussed in the following paragraphs.

A.1.2.1 Control ROM (CROM) – This memory contains the microprogram in a basic language consisting of five instructions (MOVE, OPERATE, COMPARE, BRANCH, and arithmetic operations). The CROM program has two functions:

1. Decodes the macroprogram found in the Macro ROM.
2. Performs time-sensitive functions, such as video service.

The size of the CROM is 512 16-bit words.

A.1.2.2 Macro ROM (MROM) – This memory contains a macroprogram in a language in which each instruction stands for a series of CROM instructions, or a Macro. The CROM program decodes MROM instructions by branching to one of various routines depending on the type of MROM instruction encountered. Thus, the MROM program language can have a very sophisticated repertoire without requiring excessive decoding logic. The MROM uses 4096 8-bit words to implement the VT62.

A.1.2.3 Read/Write Memory – The display memory consists of 8148 8-bit words of dynamic MOS RAM. This dynamic RAM (MK4096) contains the data displayed on the screen and screen formatting information.

A.1.2.4 Scratchpad Memory – The scratchpad memory consists of 256 8-bit words of static RAM. The static RAM is used as a scratchpad to hold microprogram constants.

A.1.2.5 Character Generation - Four 512 × 4 bipolar PROMs.

A.1.3 VT62 Overall Specifications

Dimensions	
Height	360 mm (14.1 in)
Width	530 mm (20.9 in)
Depth	690 mm (27.2 in)
Minimum Table Depth	450 mm (17.2 in)
Weight	18.86 kg (44 lb)
Plastic Case Material	Injection-molded Noryl thermoplastic
Operating Environment	DEC Standard 102 Class B environment
Temperature	10° to 40° C (50° to 104° F) 10% to 90% relative humidity with: Maximum wet bulb: 28° C (82° F) Minimum dew point: 2° C (36° F)
Line Voltage	90–127 V (115 V nominal) 180–254 V (230 V nominal) (115/230 V nominal is switch selectable)
Line Frequency	60 Hz ± 1 Hz; 50 Hz ± 1 Hz, switch selectable
Power Line Filter	RFI filter
Leakage Current	Less than 3.5 mA at 250 V, 50 Hz
Ride-Through Capability	Provides a minimum of 22 ms ride-through power during a power outage condition from low line as specified (90 V to 180 V)
Overload Protection	Fast blow fuse
Power Consumption	93 W (318 Btu hours)
Internal Power Supply	Overcurrent protected +5 V ± 5% at 8.5 A, maximum +12 V ± 5% at 1.605 A, maximum -12 V ± 5% at 0.6 A, maximum +90 V -140 V at 0.2 A -0.03 A (not used)
UL Approval	Yes
Internal Timing Source	Crystal oscillator 15.360 MHz ± 0.01%
Monitor Electronics	100% solid state
Phosphor	P4, unilluminated color may vary

Geometric Distortion The parameter of a full field of characters will approach an ideal rectangle to within $\pm 4\%$ of the rectangle height.

Video Raster scan: roll free: no need for horizontal hold and vertical hold adjustments.

TV Picture Quality The character resolution will not vary markedly across the screen nor will there be excessive pincushion nor excessive barrel distortion. What is acceptable will be that which is acceptable to the untrained observer such as clerk-typist. The picture must be clear, easy to read, and free of visual defects that impair readability.

The horizontal centering will be such that the distance of the left-hand character on the 12th line from the left screen boundary is within 13 mm (1/2 inch) of the distance from the rightmost character on the 12th line to the right screen boundary.

The vertical centering will be such that the distance of the top screen edge to the 40th character on line 1 is within 13 mm (1/2 inch) of the distance of the bottom screen edge to the 40th character on the 24th line.

The screen image will appear parallel to the table surface.

NOTE

VT62 terminals use unburned-in cathode-ray tubes and after a period of use will show dark areas across the face of the CRT where characters are displayed. The selective darkening of the CRT in no way impairs proper operation nor shortens the life of the CRT.

Display Format 24 lines of 80 characters
 Character Type 7 × 8 dot matrix
 Character Size 2.3 ± 0.4 × 3.5 ± 0.4 mm
 Screen Size 205 mm (12 in) diagonal rectangular
 Active Screen Size 218 × 114 mm (8.6 × 4.5 in)

Character Set 96 characters upper- and lowercase ASCII, plus 32 special graphic characters

Key Layout Typewriter rather than keypunch format; main keypad (63-key array); alternate keypad (19-key array)

Key click Audible sound simulates typewriter feel

Operator Controls
(Direct Access) Power ON/OFF
 Intensity Control
 BAUD RATE switches
 ON-LINE/OFF-LINE switch

Display control character switch
Key Click volume control

**Internal Setup Controls
(Limited Access)**

**PARITY/NO PARITY
EVEN/ODD PARITY
MAINTENANCE MODE
HALF-DUPLEX/FULL-DUPLEX
7 bits/8 bits (ASYNC mode only)
60/50 Hz (line frequency matching for correct screen size)
115/230 V Switch
Vertical Height
Vertical Linearity
Horizontal Size
Focus
Reverse Video Intensity**

Operator Signals

There are 8 light-emitting diodes to the right of the 19-key array on the keyboard labeled as follows (from top to bottom).

- **READY**
- **INSERT MODE**
- **KEYBOARD LOCKED**
- **DISPLAY AREA**
- **KEYING ERROR**
- **CLEAR TO SEND**
- **FUNCTION KEYPAD**
- **CARRIER**

Bell

An audible alarm sounds when CTRL G (007) is received and in other situations as described in the VT62 Functional Specification (Appendix F).

Cursor Type

Blinking reverse-video

**Communication
Synchronous
Asynchronous
Transmission Code**

Choice of 20 mA current loop, EIA (with control)
See DEC Standard 121
8-bit ASCII (U.S.) extended through escape sequences

**Transmission Code Length
10 bit (asynchronous)
11 bit**

75, 150, 300, 600, 1200, 1800, 2400, 4800, 9600 baud
110 baud only

**Transmission Character
Bit Configuration**

The VT62 has an internal set of switches that are used to select parity or no parity, even or odd parity if parity is enabled, and the number of data bits per character (7 bits or 8 bits). The bit configuration of each switch setting is shown in Figure A-1

Speed

Switch selectable; switch settings:

- **Receive at 600 baud**
- **Receive at 1200 baud**
- **Receive at 1800 baud**
- **Receive at 2400 baud**
- **Receive at 4800 baud**
- **Receive at 9600 baud**

Receive speed matches transmitter speed

- Transmit at 110 baud
- Transmit at 75 baud
- Transmit at 150 baud
- Transmit at 300 baud
- Transmit at 600 baud

Transmitter speed matches receiver speed.

Parity

Generated on transmission as even or odd or a mark (switch selectable) required on received data as a function of switch settings

WITH NO PARITY SELECTED (PARITY SWITCH OFF)

START	DATA 1 LSB	2	3	4	5	6	7	8* MSB	IDLE OR STOP – NEXT CHARACTER
-------	------------------	---	---	---	---	---	---	-----------	-------------------------------------

* TO SUPPORT DDCMP OPERATION THE 7/8 BIT (LAS 3) SWITCH MUST BE SET TO 8 AND THE PARITY/NO PARITY SWITCH (LAS 1) MUST BE SET TO NO PARITY.

MA-0933

Figure A-1 VT62 Switch Setting Bit Configurations
(Asynchronous Communication)

A.1.4 20 mA Current Loop Specifications

Transmitter	Passive, isolated goes to the mark state when power is turned off
Open Circuit Voltage	5.0 V, minimum
(of the current being driven)	50 V, maximum
Voltage Drop Marking	0.5 V, minimum
	4.0 V, maximum
Spacing Current	0.4 mA, minimum
	2.0 mA, maximum
Marking Current	20 mA, minimum
	50 mA, maximum
Receiver	Passive, isolated
Voltage Drop Marking	0.8 V, minimum
	2.5 V, maximum
Spacing Current	0.0 mA, minimum
	3.0 mA, maximum
Marking Current	15 mA, minimum
	50 mA, maximum

A.1.4.1 Baud Rates vs Distance for Integral 20 mA Loop

- Greater than 60.96 m (200 ft) at any baud rate when connected to an M596
- Greater than 304.8 m (1000 ft) at any baud rate when connected to an M5960.

A.1.4.2 20 mA Adapter Card with Cable (BN52B) Specifications – The 20 mA adapter card is supplied with a cable that ends with an 8-pin Mate-N-Lok connector for connection to DIGITAL computers. The plug may be cut off and changed as desired.

Used On	VT52, VT61, VT62
Card Size	5 × 15.2 cm (1.97 × 5.98 in)
Cable Length	4 m (13.12 ft)
Cable Type	Four wires No. 22 AWG standard
Connector Housing Type	DEC Part No. 12-09340-01 AMP 1-480460
Connector Pin Types (four required)	DEC Part No. 12-09378-03 AMP 350079-4
Connector Mates With	DEC Part No. 12-09340-00 AMP 1-480459
Female Pins (four required)	DEC Part No. 12-09379-03 AMP 350078-4

Signals from 20 mA Adapter Card	Description	Computer Signal
Transmit Positive	Wire color = green Mate-N-Lok pin = No. 7 Connects to	Receive Positive
Transmit Negative	Wire color = red Mate-N-Lok pin = No. 3 Connects to	Receive Negative
Receive Positive	Wire color = white Mate-N-Lok pin = No. 5 Connects to	Transmit Positive
Receive Negative	Wire color = black Mate-N-Lok pin = No. 2 Connects to	Transmit Negative

A.1.5 EIA (With Control) Card Specifications (BN61B)

The EIA card is supplied with a VT62 and consists of a cable and a card containing five chips that convert to and from EIA levels.

Length of Cable	5 m (16.4 ft)
Connector	Cannon DB 19604-432 or equivalent Male 25-position connector
EIA Pin No. 1	Signal: Protective ground Comment: Logic 1 = Off = -10 V
EIA Pin No. 2	Signal: Transmitted data Comment: Logic 0 = On = +10 V
EIA Pin No. 3	Signal: Received data Comment: Logic 1 = Off = -5 to 25 V Logic 0 = On = +5 to 25 V
EIA Pin No. 4	Signal: Request to send Comment: Wired true (+10 V)
EIA Pin No. 7	Signal ground
EIA Pin No. 8	Signal: EIA carrier detect
EIA Pin No. 14	Signal: EIA secondary transmitted data
EIA Pin No. 15	Signal: EIA serial clock transmit
EIA Pin No. 16	Signal: EIA secondary received data
EIA Pin No. 17	Signal: EIA serial clock receive
EIA Pin No. 20	Signal: Data terminal ready Comment: Wired true (+10 V)

The VT62 meets RS-232C by using the Motorola MC 1488 RS-232C line driver and MC 1489 RS0232C line receiver.

A.1.6 Reference Documentation

The following documentation should be referenced for a complete description of the VT62.

DEC Standard 121 – Digital Data Communications Message Protocol (DDCMP)
VT62 Functional Specification (VT62 User's Guide)

APPENDIX B

INSTALLATION PROCEDURES FOR COMMUNICATIONS OPTIONS

B.1 REMOVING THE COMMUNICATIONS OPTION

To remove the communications option, refer to Figures B-1 through B-4, unit assembly drawing 0-UA-VT62-0-0, and perform the following steps.

1. Place the unit upside down on a workbench or table (Figure B-1).
2. Remove the cable clamp securing the option cable to the base assembly (two Phillips head screws, 8-32 × 0.56).
3. Remove the base front screen (three hex-head screws, 8-32 × 0.38) using a 6.35 mm (1/4 inch) nut driver.
4. Remove the switch panel board connector P1 from J4 on the I/O board (Figure B-2).

CAUTION

Ensure that P1 is replaced correctly on J4, with the black wire of the cable toward the front of the unit. P1 incorrectly replaced on J4 will damage the I/O board upon power-up, necessitating its replacement.

5. Remove the communications option card from its socket on the I/O board. The option card plugs into one (Figure B-3) or both (Figure B-4) of the two 11-pin sockets located near the center of the I/O board. The card is secured by arrowhead snap-on fasteners. Squeeze the fastener and lift the card from its socket.

B.2 INSTALLING THE COMMUNICATIONS OPTION

To install the communications option, refer to unit assembly drawing 0-UA-VT62-0-0 and perform the following steps.

1. Remove the communications option card presently installed (Paragraph B.1).
2. Install the new card by plugging the row of straight pins on the card into the proper socket on the I/O board as shown in the applicable figure for the communications option (which follows) and secure the card. Figure B-3 shows the installation of the 20 mA communications option card. Figure B-4 shows the installation of the EIA communications option card (with control), BN61B.
3. Route the card cable approximately as shown in the applicable figure for each type of card so that the cable will exit the unit through the notch in the cable clamp provided for it.
4. Reassemble the unit by reversing steps 1 through 5 of Paragraph B.1.

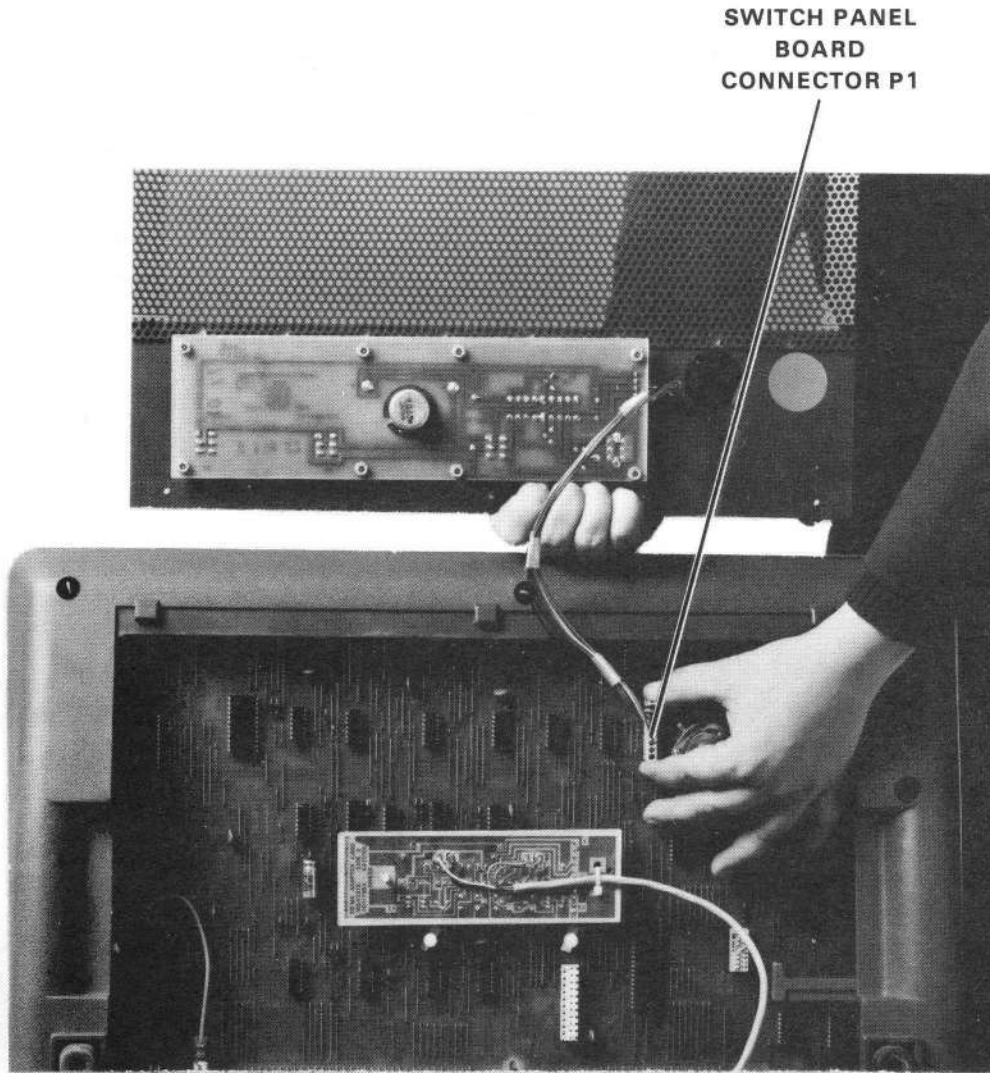

SWITCH PANEL
BOARD
CONNECTOR P1

8284-14-A0008

Figure B-2 Switch Panel Board Connector Removal

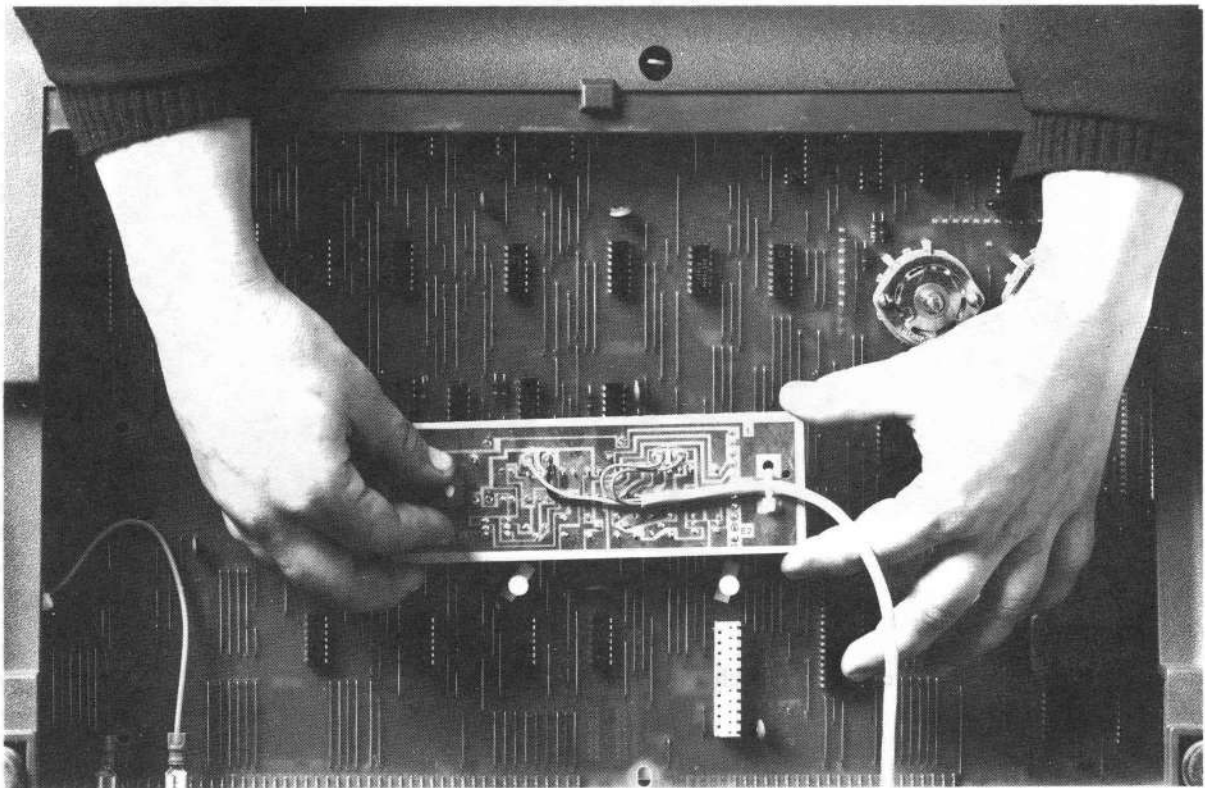

8284-20-A0025

Figure B-3 20 mA Communications Option Card Removal

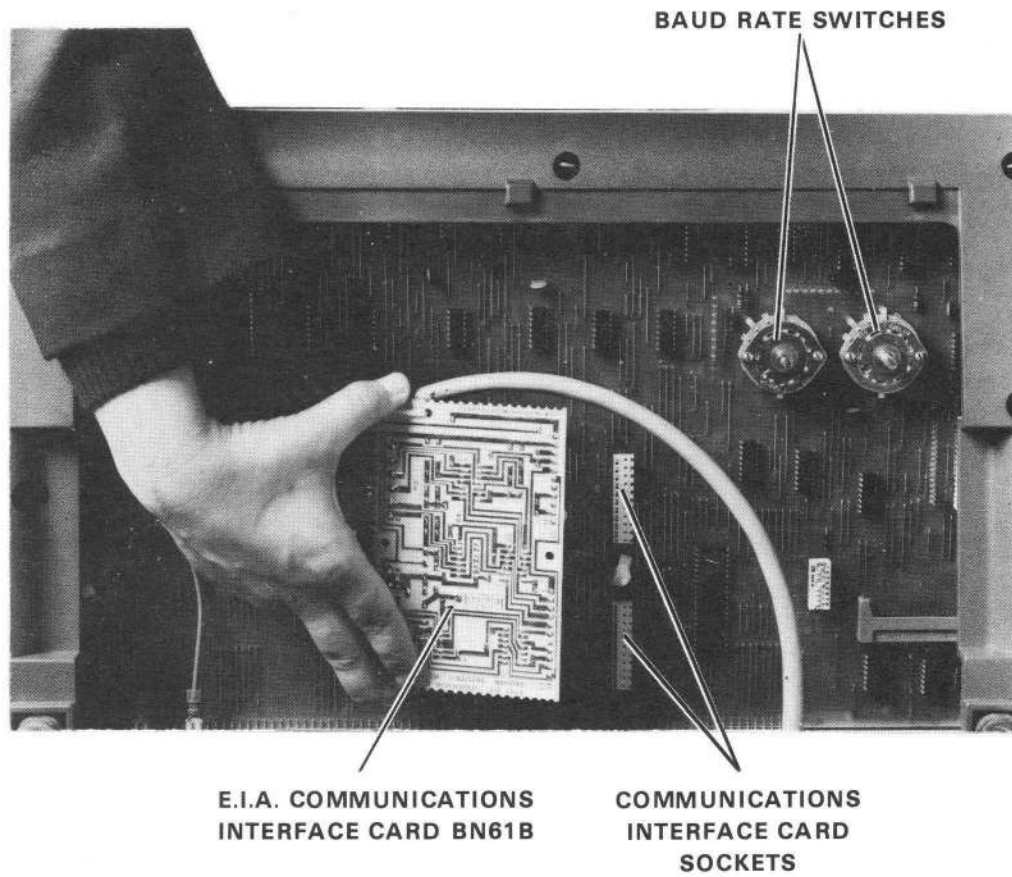

8284-12-A0026

Figure B-4 EIA Communications Option Card (BN61B) Removal

APPENDIX C ACCEPTANCE TEST PROCEDURES

C.1 VT62 OFF-LINE ACCEPTANCE TESTS

The following paragraphs list the various off-line and on-line acceptance test procedures. Should any of these tests fail, refer to the Self-Test Diagnostic Procedure in Appendix D.

C.1.1 Setup Procedure

NOTE

Perform the initial setup procedure in Chapter 2 before continuing with this procedure.

1. Ensure that the terminal line cord is not connected to an electrical outlet and that the power (ON/OFF) switch is in the OFF position.
2. Tip the unit back until it is stable to gain access to the operator control switches (Figure C-1).

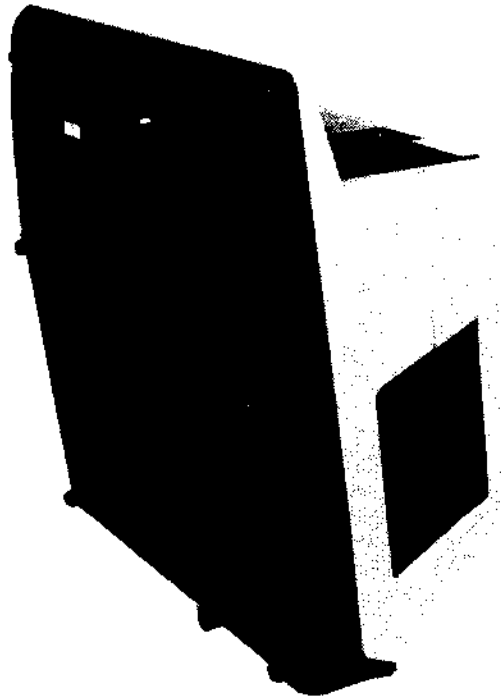

8595-10-A0028

Figure C-1 Operator Controls Access Position

3. Set the ON-LINE/OFF-LINE switch to the OFF-LINE position (Figure C-2).
4. Return the VT62 to its proper operating position.
5. Plug the 3-pronged line cord of the unit into an electrical outlet that meets the requirements of the terminal.

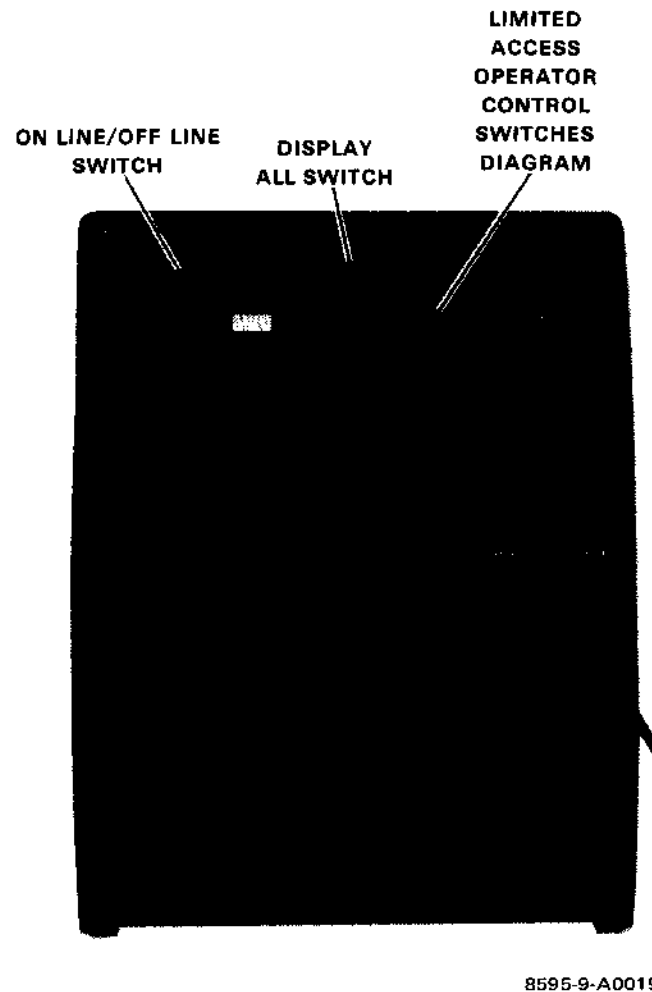

Figure C-2 VT62 Terminal, Bottom View, Base Front Screen Installed

C.1.2 Self-Test Procedure

1. Ensure that the CAPS LOCK key on the main keyboard is not in the pressed position.
2. Apply power to the terminal by setting the ON/OFF switch to ON. This switch is located on the rear of the terminal.

NOTE

The terminal enters a self-test mode immediately upon power-up. If the terminal CAPS LOCK key is in the released position, the VT62 enters long self-test mode. The VT62 will remain in this mode until the CAPS LOCK key is pressed.

3. Press the CAPS LOCK key.

NOTE

When the CAPS LOCK key is pressed, the terminal enters short self-test mode when the Long Self-Test reaches the bottom of the current screen. It then executes the Short Self-Test one time (approximately 10 seconds). At the end of the Short Self-Test, the terminal exits the short self-test mode, the cursor goes to the HOME position (at the top left corner of the display), and the keyboard is enabled.

4. Remove power from the terminal by setting the VT62 ON/OFF power switch to OFF.
5. With the CAPS LOCK key still in the pressed position, reapply power to the terminal by setting the ON/OFF switch to ON.
6. Ensure that the terminal enters short self-test mode and executes the Short Self-Test one time (approximately 10 seconds).

C.1.3 Flashing Cursor Check

At the end of the Short Self-Test, the terminal cursor will go to the HOME position and the keyboard will be enabled. Verify that the flashing cursor appears at the upper left corner of the screen (the HOME position).

Using the intensity control located on the rear of the terminal (Figure C-3) adjust the brightness of the cursor to the desired level. For comfortable viewing, set the brightness to the lowest possible level while still maintaining good character definition. High screen intensity causes characters to become fuzzy; prolonged viewing of the bright display is very tiresome.

C.1.4 Display All Check

The terminal may display a dot in each character position. This is caused by the DISPLAY ALL switch being in the DISPLAY ALL position.

Move the DISPLAY ALL switch (Figure C-2) several times between the DISPLAY ALL and normal positions and verify that these dots can be made to appear and disappear. Place the DISPLAY ALL switch in the normal position. (The normal position of the DISPLAY ALL switch is toward the front of the terminal.)

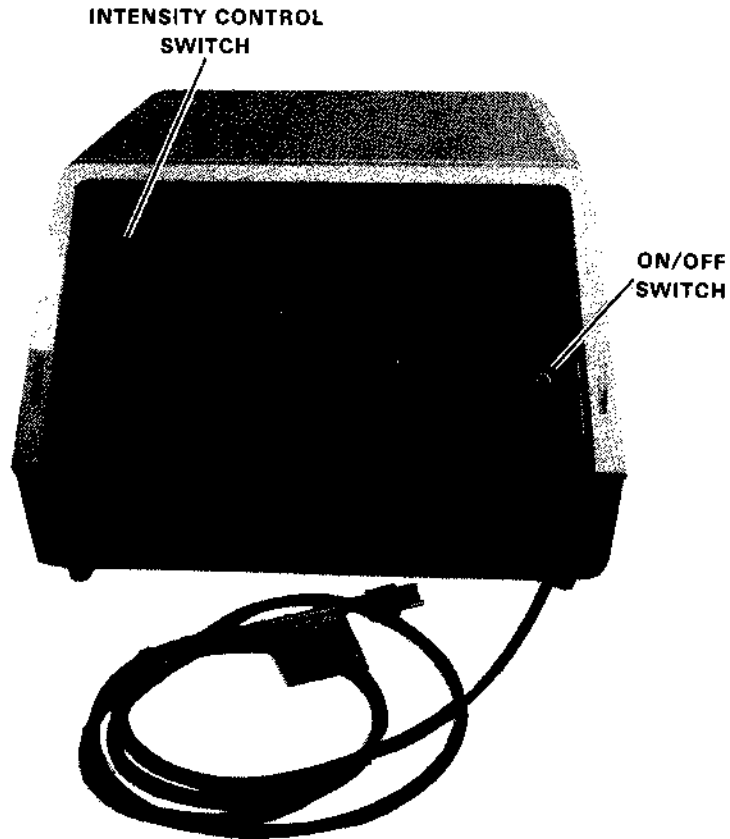

8595-5-A0004

Figure C-3 VT62 Terminal, Rear View

C.1.5 CAPS LOCK Check

Note the key labeled CAPS LOCK on the main keyboard (Figure C-4). This key is similar to the SHIFT LOCK key on a typewriter except that CAPS LOCK shifts capital letters only and will not shift anything other than letters. Keys with numbers or symbols are not affected by CAPS LOCK. To get the uppercase of these keys, press the SHIFT key. The SHIFT key will also give you capital letters while CAPS LOCK is off. Press the various alphabetic and numeric keys on the keyboard. Check that the terminal displays the characters as the keys are pressed. Verify that the CAPS LOCK key is functioning.

C.1.6 OFF-LINE Operating Mode Check

1. Type a character. The character will appear on the screen at the cursor location and the cursor will move one character location to the right.
2. With the REPEAT key held down, type another character. The character will appear in all remaining locations of the top line and the cursor will be under column 79 (last column).
3. Type a different character. It will replace the last character in the line because that is the cursor location. The cursor advances automatically as characters are typed until it reaches the last character position in the line. RETURN and LINE FEED must be typed at the end of each line.

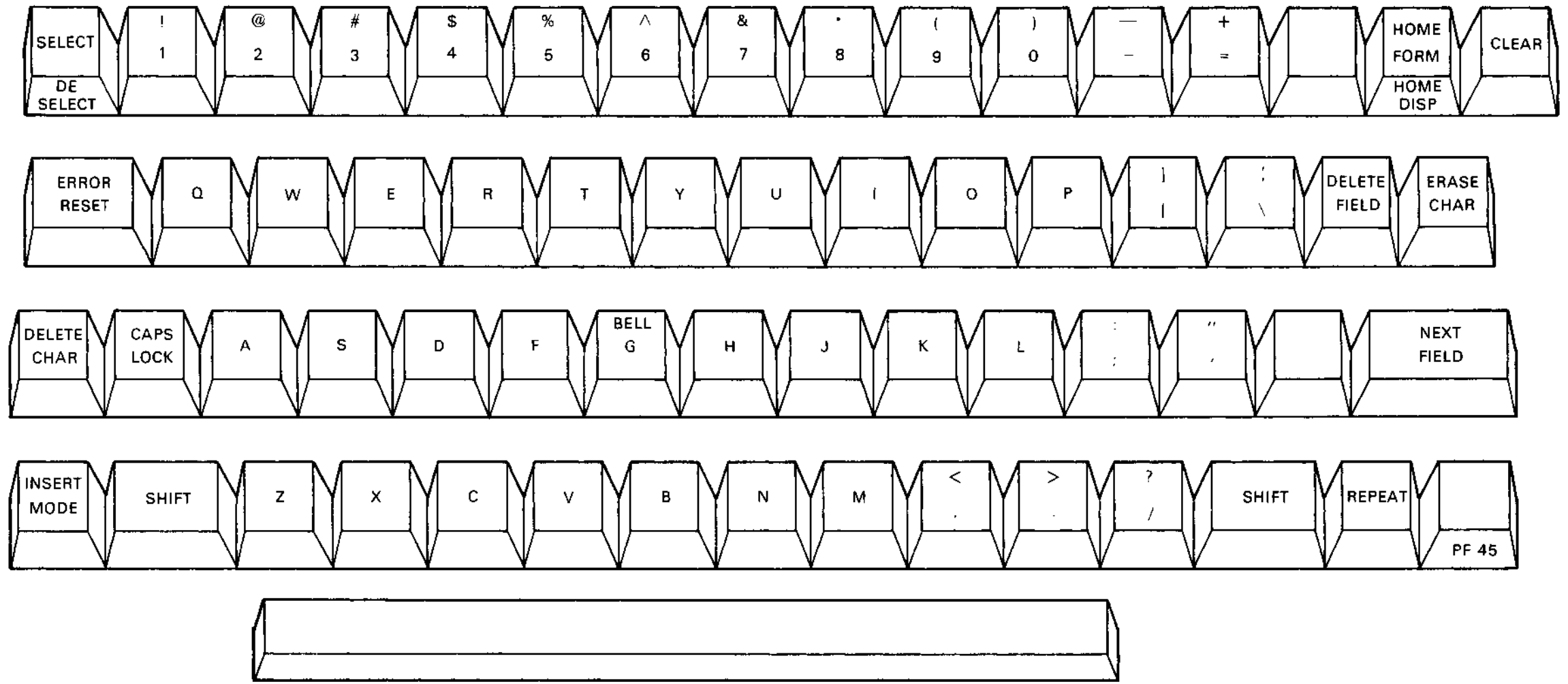

MA-0930

Figure C-4 VT62 Main Keyboard

4. Type the RETURN key. The cursor will move to the left end of the line. Now type LINE FEED. The cursor will move down to the next line. Type a few characters to form the second line.
5. Try the rest of the cursor move keys. They will all move the cursor one character position. The BACK SPACE key will move the cursor to the left; the four cursor move keys on the auxiliary keypad will move the cursor one character position in the direction indicated by the arrow.
6. Move the cursor to the left-hand margin on a blank line. Alternately type a character and TAB. The typed characters will appear eight character locations apart. These are the TAB STOP locations. If the cursor is at the end of the line, TAB will not move the cursor.
7. Position the cursor under a displayed character and type SPACE BAR. The character will be replaced with a space and the cursor will be advanced one character position. The space bar may be used for erasing.
8. Type some characters with the SHIFT key and then with the CAPS LOCK key held down. Alphabetic characters will appear in uppercase when typed with either SHIFT or CAPS LOCK pressed. Numeric keys are not affected when CAPS LOCK is down. Symbols associated with numeric keys are displayed only when the numeric keys are typed with the SHIFT key held down.
9. Move the cursor to the left-hand margin of the bottom line. With REPEAT held down, type a character key and fill the bottom line.

Type RETURN and LINE FEED. The terminal will move all lines up by one position erasing the bottom line for new entries. The top line is lost in this operation. This is called scrolling and will occur whenever a LINE FEED is typed while the cursor is on the bottom line.

C.1.7 Escape, Control, and Function Commands

Escape and control commands are invoked by:

1. Pressing the SELECT (escape) key (Figure C-4) and following with the character that identifies which escape function is to be performed.
2. Holding down the DELETE CHARACTER (control) key and simultaneously typing a character to identify which control function is to be performed.

Note that the ESCAPE key need only be typed once and then followed by the identifying character (or characters), while the CONTROL key must be held down while the identifying character is being typed.

C.1.8 Escape, Control, and Function Command Checks

1. Audible Alarm Check
 - a. Hold down the DELETE CHAR key and simultaneously type the letter G.

Verify that the audible alarm sounds. If the audible alarm does not sound, adjust the VOLUME potentiometer on the bottom of the terminal and repeat the procedure.

2. **Terminal Self-Test**

- a. Press the **CAPS LOCK** key.
- b. Press the **SELECT** key.
- c. Press the **S** key. The terminal should execute a self-test.

During the test, the screen will be filled with characters and the audible alarm will sound. Upon completion of the test (approximately 5 seconds), the cursor will appear at home position and the screen will reset.

- d. Release the **CAPS LOCK** key.

APPENDIX D

VT62 OFF-LINE MODE CHARACTERISTICS

D.1 GENERAL

When the VT62 is placed in the OFF-LINE mode (see the procedure given in C.1.1), the VT62 operates much like the VT52 video display terminal does in its off-line mode. (See the *DECscope Users Manual*, EK-VT5X-OP-001.)

D.1.1 Keyboard

Typing keys on the main keyboard or the auxiliary keypad generates upper- and lowercase alphabetic characters and numeric characters which are displayed on the screen as well as the control code which can change the position of the cursor, run Self-Test, etc.

D.1.1.1 Alphabetic Keys – All alphabetic keys generate upper- and lowercase characters. Uppercase is produced when a key is typed while either or both SHIFT keys are down or while the CAPS LOCK key is down. (The CAPS LOCK key does not affect keys other than the alphabetic keys.)

D.1.1.2 Function Keys – Function keys cause an action to occur in the terminal such as tab, line feed, etc. Table D-1 lists the function keys and the terminal action taken.

Table D-1 Function Keys

Key	Action Taken
RETURN	Carriage Return function
LINE FEED	Line Feed function
BACKSPACE	Backspace (Cursor Left) function
TAB	Tab function
SPACE BAR	Deposit a space on the screen, erasing what was there before
DEL CHAR	Interpret the next character as a command, rather than displaying it

D.1.1.3 The DELETE CHAR (Control) Key – The CONTROL key is used in conjunction with other keys on the keyboard to produce control codes. When held down, it alters the code normally produced by a typed key. Table D-2 lists the actions which occur when the CTRL key is held down and the designated key is pressed.

Table D-2 Control Key Functions*

Key	ASCII Code	Action Taken
G	7	Bell
H	10	Backspace (Cursor Left)
I	11	Horizontal Tab
J	12	Line Feed
K	13	Unimplemented
L	14	Unimplemented
M	15	Carriage Return

*The DELETE CHAR key must be held down while typing the character key.

D.1.1.4 The SELECT (Escape) Key - The ESCAPE key, like the CONTROL key, is used to give the terminal special commands. However, unlike the CONTROL key, it does not need to be held down while another key is pressed. The only requirement to begin an Escape sequence is to first press the SELECT key. Table D-3 defines the various escape sequences. In addition to the method of generating Escape sequences described in Table D-3, the VT62 can generate three of these sequences a second way. Table D-4 describes these keys and their functions.

D.1.1.5 Auxiliary Keypad - The 19-key auxiliary keypad is provided for applications requiring heavy use of the numeric keys. In addition to the 10 numeric keys, the keypad has a decimal point key, 4 cursor move keys, 3 blank keys, and an ENTER key.

In normal mode the decimal point key and the numeric keys generate the same characters as the decimal point key and the numeric keys on the main keyboard. The ENTER key generates the same code as the RETURN key. When the command ESC = is typed on the keyboard, the terminal will enter the alternate-keypad mode and the ENTER, decimal point, and numeric keys will each generate a unique Escape sequence.

Table D-5 lists the codes generated by these keys. The seven remaining keys on the keypad are the four cursor move keys and three blank keys. A cursor move key generates an Escape sequence that will move the cursor one character position up, down, left, or right, depending upon the typed key. The three blank keys transmit defined Escape sequences. Table D-6 lists the codes generated by these seven keys.

None of the keys on the auxiliary keypad are affected by pressing the SHIFT, CAPS LOCK, or CTRL keys.

D.1.1.6 The REPEAT Key - The REPEAT key is used in conjunction with other keys. Any key that generates a character will generate that character repeatedly if pressed while the REPEAT key is down.

D.1.1.7 The COPY Key - The COPY key is also a local function key. When typed, the COPY key will produce a hard copy of the current screenful of characters if the optional LA180 DEC printer is attached.

Table D-3 Escape Key Functions

Typing the SELECT key; then typing the key with this marking on the keycap. . .	generates the following ASCII code. . .	and performs the function (or ESCAPE SEQUENCE) called. . .
=	075	Enable Alternate Keypad Mode
	076	Disable Alternate Keypad Mode
?	077	Unimplemented
@	100	Unimplemented
A	101	Cursor Up
B	102	Cursor Down
C	103	Cursor Right
D	104	Cursor Left (Backspace)
F	106	Enable Graphics Mode
G	107	Disable Graphics Mode
H	110	Cursor to Home
I	111	Scroll Down (Rev Line Feed)
J	112	Erase to End of Screen (EOS)
K	113	Erase to End of Line (EOL)
L	114	Enable Loop-Back Mode
M	115	Enable Maintenance Mode ¹
N	116	Disable Loop-Back, Raster Modes
O	117	Unimplemented
P	120	Self-Test
Q	121	Enable Raster Test
R	122	Reset
S	123	Self-Test
T	124	Enable Reverse Video
U	125	Disable Reverse Video
V	126	Print Cursor Line
W	127	Enable Printer-Controller Mode
X	130	Disable Printer-Controller Mode
Y	131	Direct Cursor Addressing
Z	132	Identify Terminal Type
[133	Enable Hold-Screen Mode
	134	Disable Hold-Screen Mode
]	135	Print the Screen
	136	Enable Auto-Print Mode
-	137	Disable Auto-Print Mode

¹To disable the Maintenance Mode/Diagnostic Mode, type the V (033) and keypad 3 (105) keys.

Table D-4 Special ESC Functions

Typing the keypad key with this VT62 marking on the keycap	is like typing this Escape Sequence...	and generates this ASCII code...	and performs the function (or Escape Sequence) called...
← Back Field Forward Field	ESC P ESC Q ESC R	120 121 122	Self-Test Enable Raster Test Reset

Table D-5 Keypad Numeric Keys

Key	VT62 Not In Alternate-Keypad Mode	VT62 In Alternate-Keypad Mode
0	0	ESC?p
1	1	ESC?q
2	2	ESC?r
3	3	ESC?s
4	4	ESC?t
5	5	ESC?u
6	6	ESC?v
7	7	ESC?w
8	8	ESC?x
9	9	ESC?y
ENTER	ENTER	ESC?M

Table D-6 Keypad Control Keys

Keypad Key	Escape Sequence Generated
Left Arrow*	ESC P
Backfield*	ESC Q
Forwd Field*	ESC R
Right Arrow	ESC A
Stop Repeat	ESC B
Close	ESC C
Affirm	ESC D

*See Table D-4.

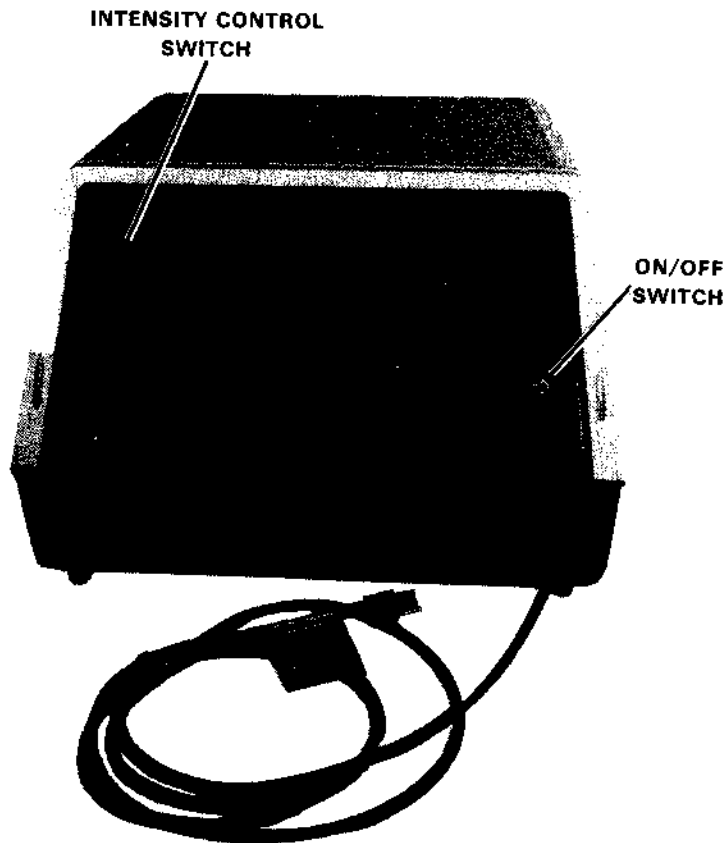

8595-5-A0004

Figure D-1 VT62 Terminal, Rear View

1. Tip the unit up and set the ON-LINE/OFF-LINE switch to OFF-LINE (Figure D-2).
2. Return the VT62 to its proper operating position.
3. Plug the 3-pronged line cord of the unit into an electrical outlet that meets the requirements of the terminal.

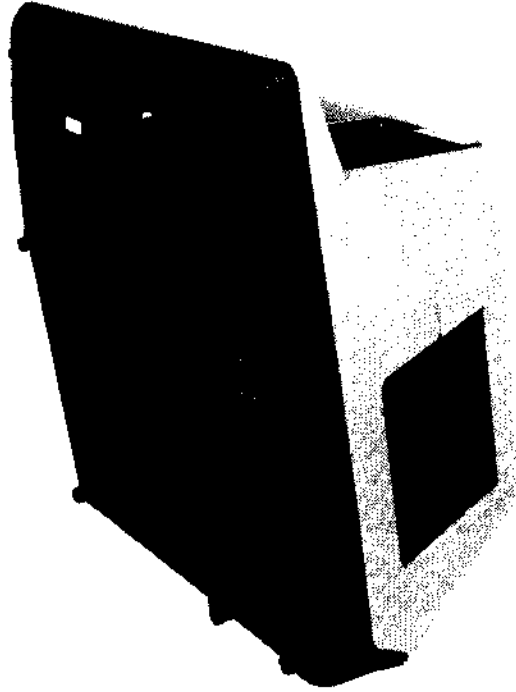

8595-10-A0028

Figure D-2 Operator Access Position

4. Press the CAPS LOCK key on the main keyboard (Figure D-3).
5. Apply power to the terminal by setting the ON/OFF switch to ON. This switch is located on the rear of the terminal.

NOTE

The terminal enters a self-test mode immediately upon power-up. If the terminal CAPS LOCK key is not in the pressed position, the terminal enters long self-test mode. The VT62 will remain in this mode until the CAPS LOCK key is pressed. When the CAPS LOCK key is pressed, the terminal enters short self-test mode and executes the Short Self-Test one time (approximately 10 seconds). At the end of the Short Self-Test, the terminal exits the self-test mode, the cursor goes to the HOME position (at the top left corner of the display), and the keyboard is enabled.

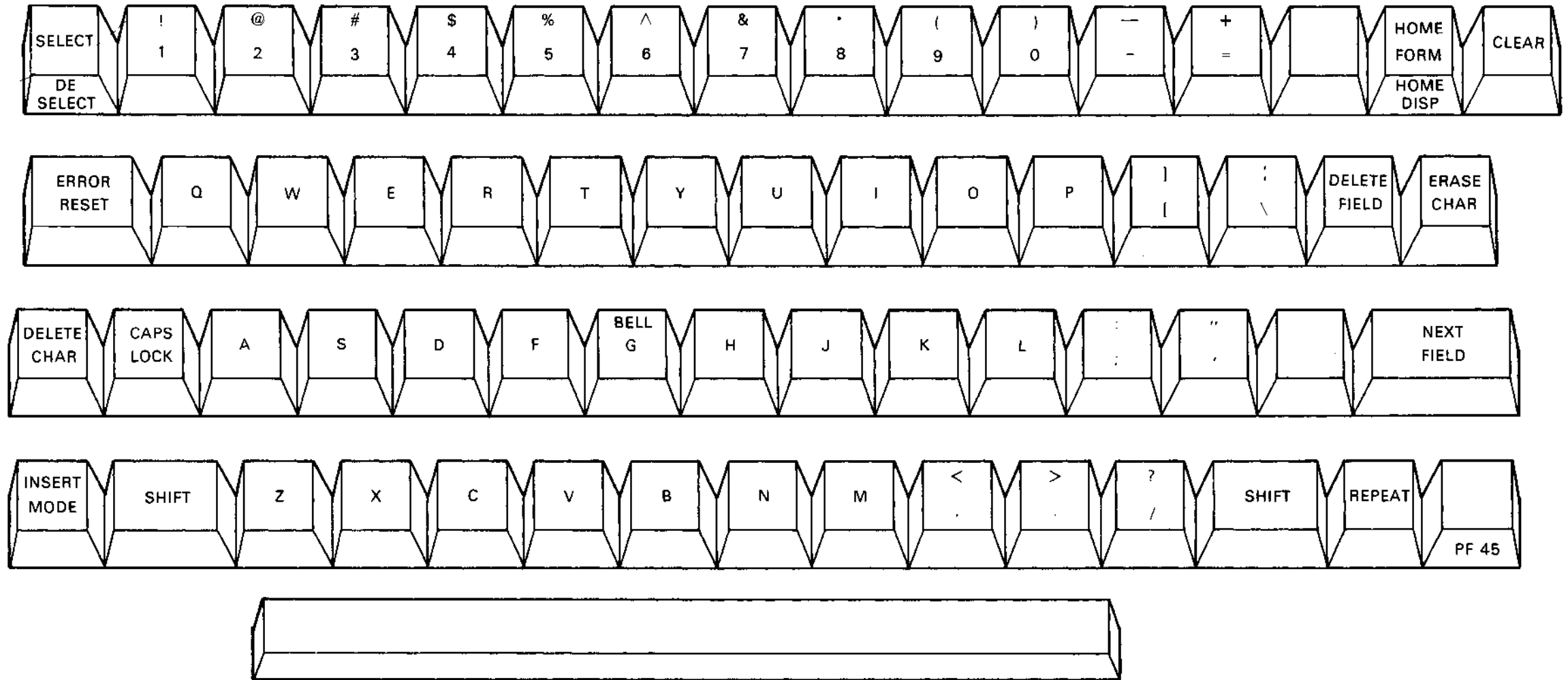

MA-0930

Figure D-3 VT62 Main Keyboard

D.2.1 Operating Characteristics

1. Type a character. The character will appear on the screen at the cursor location and the cursor will move one character location to the right.
2. With the REPEAT key held down, type another character. The character will appear in all remaining locations of the top line and the cursor will be under column 79 (last column).
3. Type a different character. It will replace the last character in the line because that is the cursor location.

The cursor advances automatically as characters are typed until it reaches the last character position in the line.

RETURN and LINE FEED must be typed at the end of each line.

4. Type the RETURN key. The cursor will move to the left end of the line. Now type LINE FEED. The cursor will move down to the next line. Type a few characters to form the second line.
5. Try the rest of the cursor move keys. They will all move the cursor one character position. The BACKSPACE key will move the cursor to the left; the four cursor move keys on the auxiliary keypad will move the cursor one character position in the direction indicated by the arrow.
6. Move the cursor to the left-hand margin on a blank line. Alternately type a character and TAB. The typed characters will appear eight character locations apart. These are the TAB STOP locations. If the cursor is at the end of a line, TAB will not move the cursor.
7. Position the cursor under a displayed character and type SPACE BAR. The character will be replaced with a space and the cursor will be advanced one character position.

The space bar may be used for erasing.

8. Type some characters with the SHIFT key and then with the CAPS LOCK key held down. Alphabetic characters will appear in uppercase when typed with either SHIFT or CAPS LOCK pressed. Numeric keys are not affected when CAPS LOCK is held down. Symbols associated with the numeric keys are displayed only when the numeric keys are typed with the SHIFT key held down.
9. Move the cursor to the left-hand margin of the bottom line. With REPEAT held down, type a character key and fill the bottom line.

Type RETURN and LINE FEED. The terminal will move all lines up by one position, erasing the bottom line for new entries. The top line is lost in this operation. This is called scrolling and will occur whenever a LINE FEED is typed while the cursor is on the bottom line.

D.3 DIAGNOSTIC OPERATING MODES

The VT62 diagnostic modes are described in more detail in the following paragraphs.

D.3.1 Self-Test Diagnostic Mode

The VT62 Self-Test Diagnostic Mode, initiated automatically upon power-up, may be invoked manually with an Escape sequence (Tables D-3 and D-4).

When initiated, the VT62 Self-Test begins with three distinct tests in the Control ROM (CROM). These tests are shown chronologically in Table D-7.

The Self-Test uses the terminal LED display (Figure D-4) to indicate the current test according to Table D-8. The Self-Test is terminated upon finding an error. CROM-level tests are terminated upon finding an error without the error being displayed on the screen. The LEDs ensure that the error condition is displayed. If the "C" key is pressed, the VT62 will attempt to display the error on the screen.

Table D-7 Self-Test (CROM level)

Test	LED Error Display
1. DISPATCH ROM TEST	00010000
2. ROM BANK TEST	0010BBBB (BANKS 1 to 8)*
3. STATIC RAM TEST	01000000

*1-10 octal

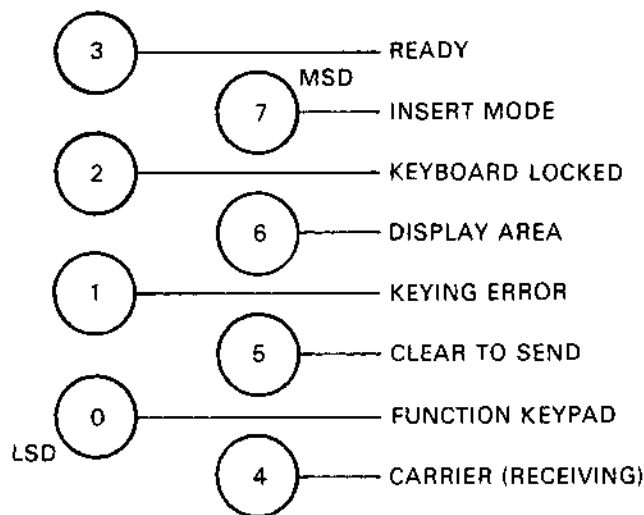

MA-0932

Figure D-4 LED Display

Table D-8 Self-Test Error LED Display

When an error occurs During this test:	This LED will light
Dispatch ROM Test	Carrier
ROM Bank Test	CLEAR TO SEND
1.	FUNCTION KEYPAD
2.	KEYING ERROR
3.	KEYING ERROR/FUNCTION KEYPAD
4.	KEYBOARD LOCKED
5.	KEYBOARD LOCKED/FUNCTION KEYPAD
6.	KEYBOARD LOCKED/KEYING ERROR
7.	KEYBOARD LOCKED/KEYING ERROR/FUNCTION KEYPAD
8.	READY
Static RAM Test	DISPLAY AREA
Dynamic RAM Test	INSERT MODE

If no errors occur during the testing of the Dispatch ROM, the ROM banks, and scratchpad memory (all CROM-level tests), Self-Test continues at the Macro ROM level with the Dynamic RAM Test. Should an error occur at this level, the LED error display would indicate an octal 200. Finally, the Self-Test results are displayed on the screen on line 24. If the VT62 passes the Self-Test, an English-language message, SELF-TEST PASS will be indicated on line 24 of the screen. In addition, all LEDs will illuminate as a visual LED check. However, if an error condition is present, the "pass message" is replaced with an English language error message on line 24. These error messages are as follows:

ERROR, ROM BANK X (BANKS 1-8)
 ERROR, RAM BANK X (BANKS 1, 2, or 3)
 ERROR, DROM

All Self-Test results are displayed temporarily on line 24 and permanently on line 25.

D.3.2 Test Diagnostic Fault Locating Procedure

D.3.2.1 Installation of the VT62 Field Service Test Card – The following steps must be accomplished before the test diagnostic fault locating procedure can be performed.

1. The base assembly removal procedure
2. The Field Service test card installation procedure

D.3.2.1.1 Removing the Base Assembly – To remove the base assembly, refer to Figures D-5 through D-8 and perform the following.

1. Unplug the line cord.
2. Place the unit upside down on a workbench or table (Figure D-5).

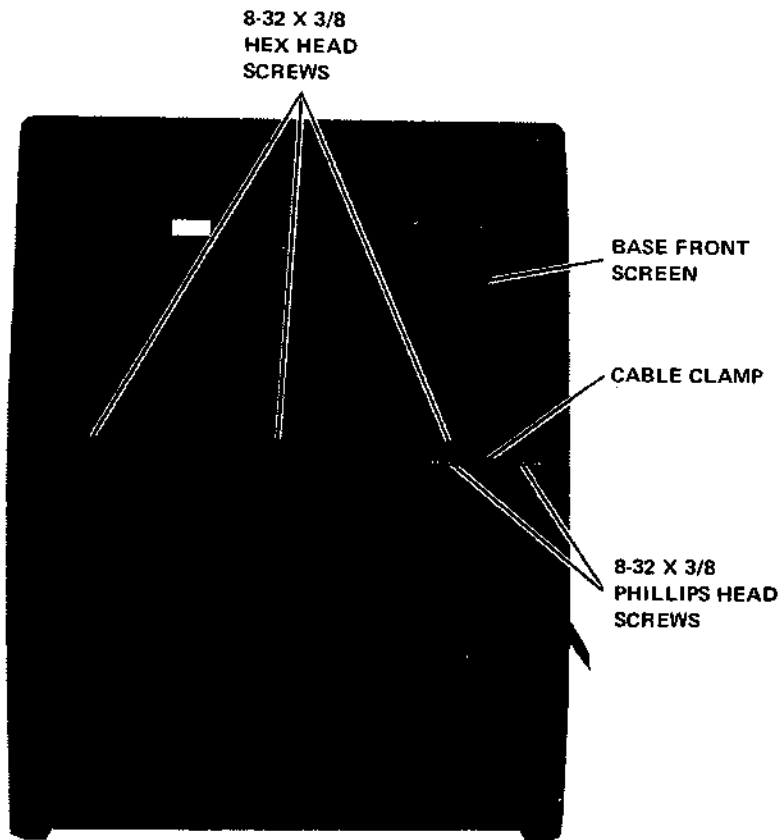

8595-9-A0001

Figure D-5 VT62 Terminal, Bottom View

3. Remove the cable clamp securing the option cable to the base assembly (2 Phillips head screws 8-32 × 3/8).
4. Remove the base front screen (three hex-head screws, 8-32 × 3/8) using a 1/4 inch nut driver.
5. Remove the switch panel board connector P1 from J4 on the I/O board (Figure D-6).

CAUTION

Ensure that P1 is replaced correctly on J4, with the black wire of the cable toward the front of the unit. P1 incorrectly replaced on J4 will damage the I/O board upon power-up, necessitating its replacement.

6. Remove the communications option card from its socket on the I/O board. (See Figure D-7 and Appendix B.)
7. Remove the hex-head screw (8-32 × 3/8) located in top left center on the louvered heat sink plate (using a 1/4 inch nut driver).

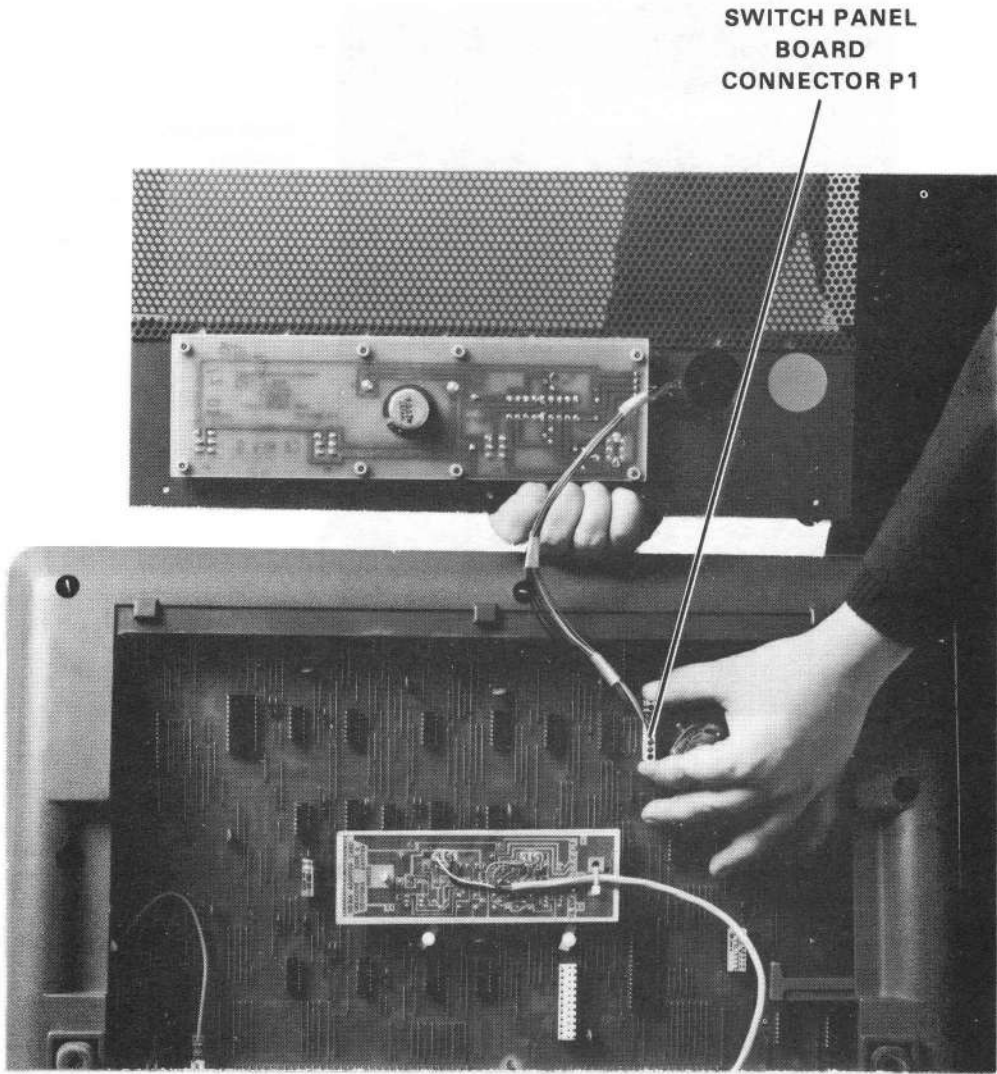

8284-14-A0008

Figure D-6 Switch Panel Board Connector Removal

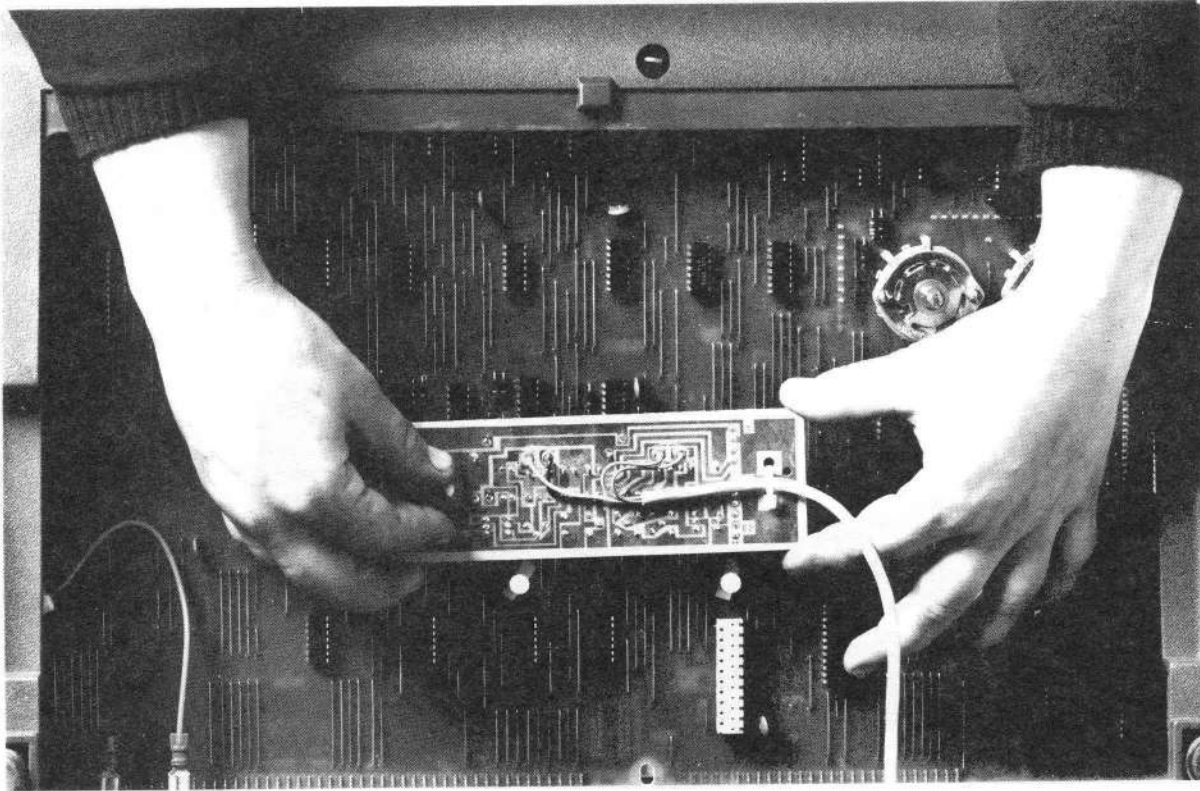

8284-20-A0025

Figure D-7 20 mA Communications Option Card Removal

8. Remove the base assembly from the shell by first turning the 1/4 turn fasteners 90 degrees counterclockwise (five places). Notice that the five 1/4 turn fasteners are *not* removed, but merely turned (using a 1/4 inch nut driver) 90 degrees counterclockwise to loosen, and 90 degrees clockwise to tighten (Figure D-8).
9. Reverse steps 1 through 8 to reassemble.

D.3.2.1.2 VT62 Field Service Test Card Installation – To install the VT62 Field Service test card, refer to Figures D-9 and D-10 and perform the following.

1. Insert the test diagnostic card into J19 and J20 on the processor/video board (Figure D-9).
2. Place the test diagnostic card switch in the up position (Figure D-10).

D.3.2.2 Test Diagnostic Fault Locating Procedure

1. Plug in the line cord.
2. Place the ON-LINE/OFF-LINE switch in the OFF-LINE position.
3. Place the terminal's power (ON/OFF) switch in the ON position. All of the LED indicators in the terminal LED display should now illuminate.



1/4 TURN FASTENERS

8-32 HEX-HEAD SCREW

1/4 TURN FASTENER

8284-26

Figure D-8 Base Assembly Removal

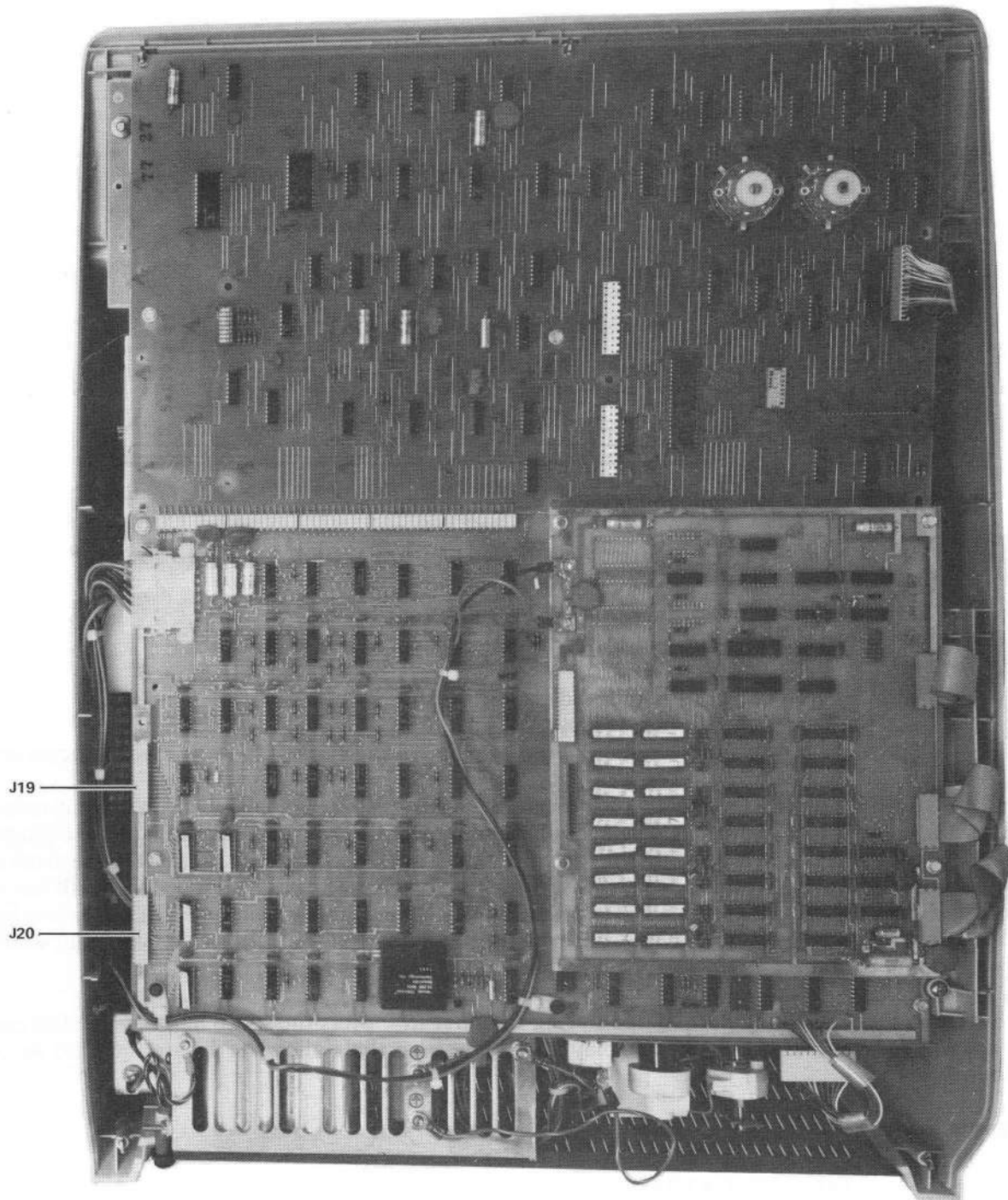

8595-3-A0009

Figure D-9 Location of J19 and J20

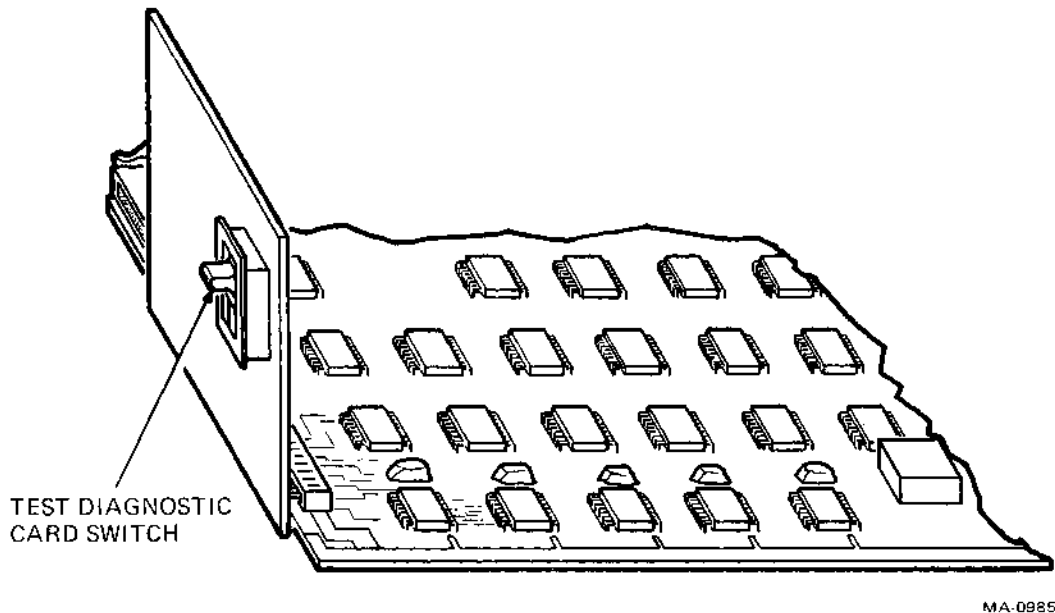

Figure D-10 Test Diagnostic Card Installed

If the terminal's LED display does not totally illuminate, perform the following.

1. Ensure that the line cord is plugged in.
2. Check the power supply fuse (Figure D-11).
3. Measure the power supply voltages. Replace the power supply if the voltages are incorrect.

The diagnostic uses the LED display to indicate which test the terminal failed. When an error is detected, the current test number is displayed in octal on the LED display according to the diagram shown in Figure D-12. Obviously, this diagnostic only works well if all of the LEDs are working. Therefore, the diagnostic program first tries to turn on all LEDs for visual inspection. If all but one LED light during this test, the unlit LED is probably defective. If more than one LED does not light, chances are that something else may be causing this initial test to fail. In this case, you may want to proceed, hoping that the LED display will actually point to a failing test.

If all LEDs in the display are illuminated during this first test, press the space bar and the diagnostic program will continue. Use the LED display and the test list that follows to locate the fault in your terminal.

Diagnostic Tests

1. Test 0 - Power-Up Flag Test
 - a. Replace I/O board
 - b. Replace processor/video board
2. Test 1, Test 2 - Accumulator Test
 - a. Replace processor/video board
 - b. Replace I/O board
 - c. Replace keyboard

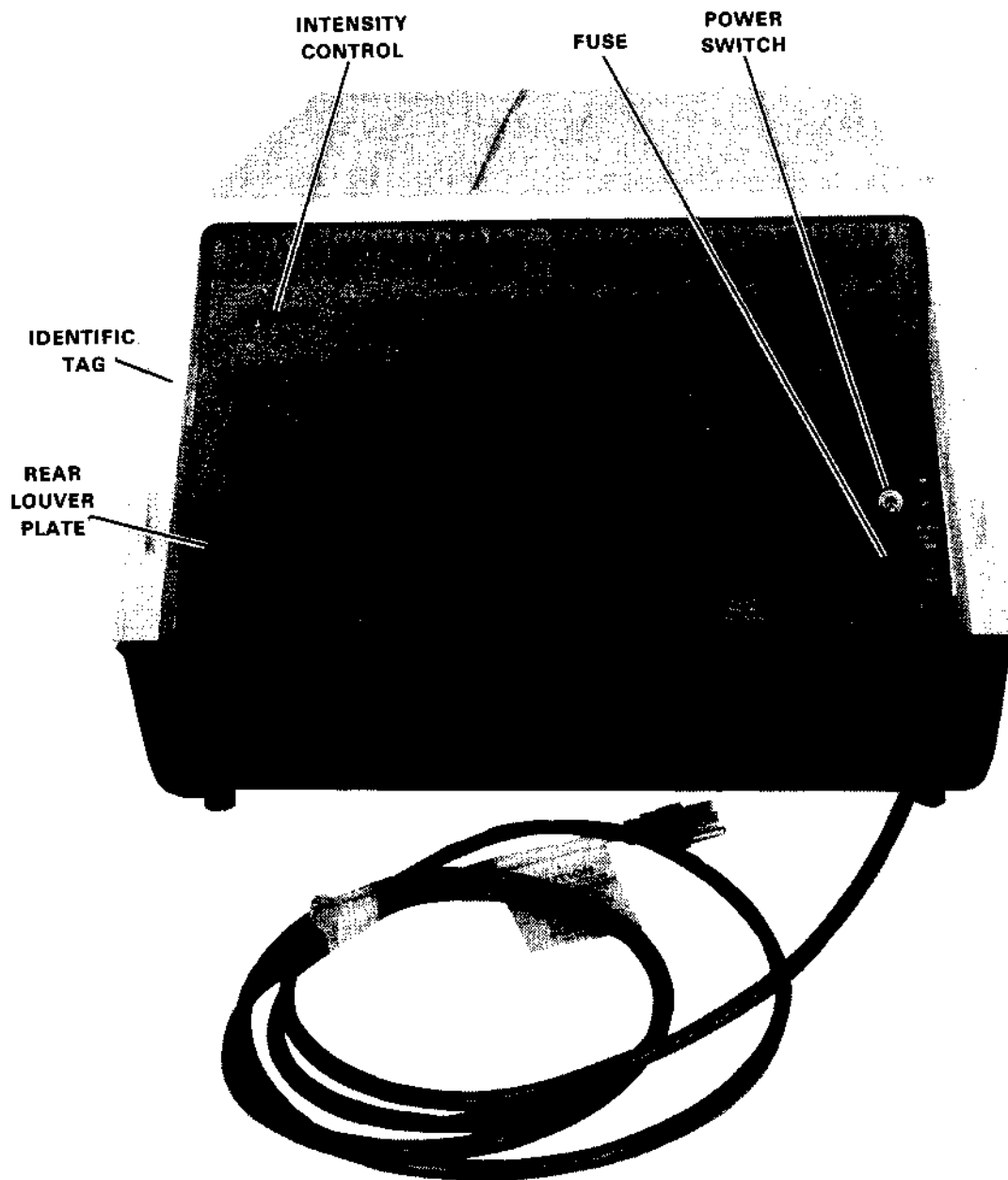

8596-5-A0005

Figure D-11 VT62 Terminal, Rear View

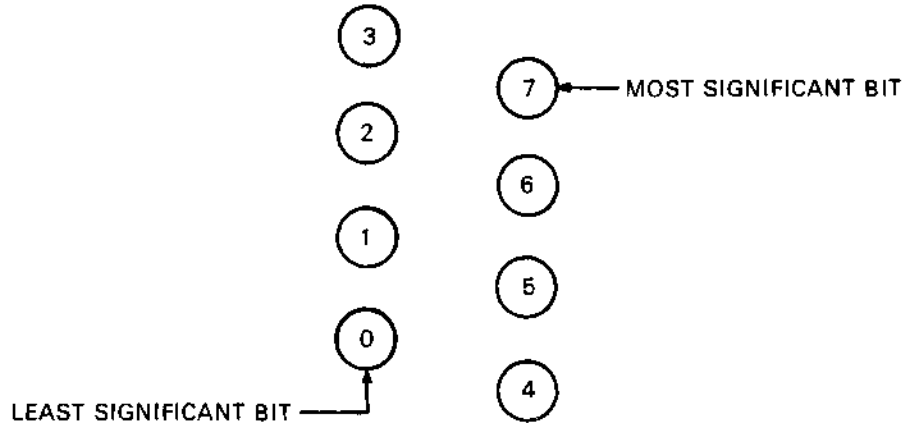

CP-2820

Figure D-12 VT62 Terminal LED Octal Bit Pattern

3. Test 40 – Test 50 – ALU Functions Test
 - a. Replace processor/video board
 - b. Replace I/O board
 - c. Replace keyboard.
4. Test 51 – Scratch Pad Memory Test
 - a. Replace processor/video board
 - b. Replace I/O board
 - c. Replace keyboard.
5. Test 52 – Branch Flag Test
 - a. Replace processor/video board
 - b. Replace I/O board.
6. Test 53-53B – Display Status and Terminal Address Test
 - a. Before the test, press one of the following keys:
 - (1.) “A” to display status register in the LEDs
 - (2.) “S” to display the terminal address in the LEDs
 - b. Press space bar to start the test
 - c. Program will continue when “A” or “S” key is released.
7. Test 54 – UART Test
 - a. Check that terminal is in LOCAL
 - b. Check +12 V and -12 V
 - c. Replace I/O board
 - d. Replace processor/video board
 - e. Replace memory board.

8. Test 55 - F1, F2, A and B Flag Test

- a. Replace the processor/video board
- b. Replace the I/O board
- c. Replace the memory board.

9 Test 56 - Modem and Misc. Flag Test

- a. Press the ESC (select) key
- b. Press the space bar to start test
- c. Replace I/O board
- d. Replace processor/video board.

(Program will remain in this test as long as the ESC (select) key is held down.)

10. Test 57 - Memory Data Register Test

- a. Replace I/O board
- b. Replace processor/video board
- c. Replace memory board.

11. Test 100-110 - Static and Dynamic RAM Test

- a. Replace memory board
- b. Replace processor/video board
- c. Replace I/O board.

12. Test 112 - Dispatch ROM Test

- a. Replace processor/video board
- b. Replace memory board
- c. Replace I/O board.

13. Test 113 - MACRO ROM Test

- a. Replace memory board
- b. Replace processor/video board
- c. Replace I/O board.

14. Test 114 - Video Test (Program halts on error; no video is displayed on the screen.)

- a. Replace processor/video board
- b. Replace I/O board
- c. Replace memory board
- d. Replace monitor board
- e. Replace power supply.

15. Program Runs But Video Check Fails

- a. Replace memory board (characters change)
- b. Replace I/O board
- c. Replace monitor board
- d. Replace power supply
- e. Replace processor/video board.

16. Display Jitter

- a. Check 50/60 hertz switch
- b. Replace processor/video board
- c. Replace I/O board.

If terminal passes the test diagnostic but is still bad when running normal program:

- a. Replace processor/video board
- b. Replace input/output board
- c. Replace 20 mA current-loop or other interface options that may be used
- d. Replace switch board.

The diagnostic program runs sequentially through a series of tests. At the end of the test the program verifies that the unit executed it properly. The program will repeat the test if there is an error. The LEDs are normally used to display the test number, however, in some tests these LEDs are used for other information.

During the RAM tests the keyclicker will sound approximately 5 to 10 times per second. This is only to give the operator some indication that the program is still running.

Total run time of the diagnostic program is approximately 5 minutes; however, a shorter version of the program may be run by releasing the CAPS LOCK key to its up position. This causes Test 102, 105 and 110 (memory addressing test) to do a partial test of memory.

Special keyboard functions are as follows:

"A" Key =	Display Status in LEDs
"S" Key =	Display Terminal Address in LEDs
"ESC" Key =	Repeat Loading Modem and Misc Flags
KPAD "8" =	Abort Dispatch ROM Test on Error
KPAD "<--" =	Skip UROM Test
"1" Key =	Display Bank # in the LEDs
"2" Key =	Restart UROM Test on Error
"C" Key =	Repeat Video Test
"BREAK" Key =	Restart Test on Error (RAM Tests Only)
"REPEAT" Key =	Repeat Current Failing Test (RAM Tests Only)

APPENDIX E VT62 TERMINAL INTERFACING

E.1 TERMINAL INTERFACE SPECIFICATIONS

The VT62 terminal interface is shown in Figure E-1.

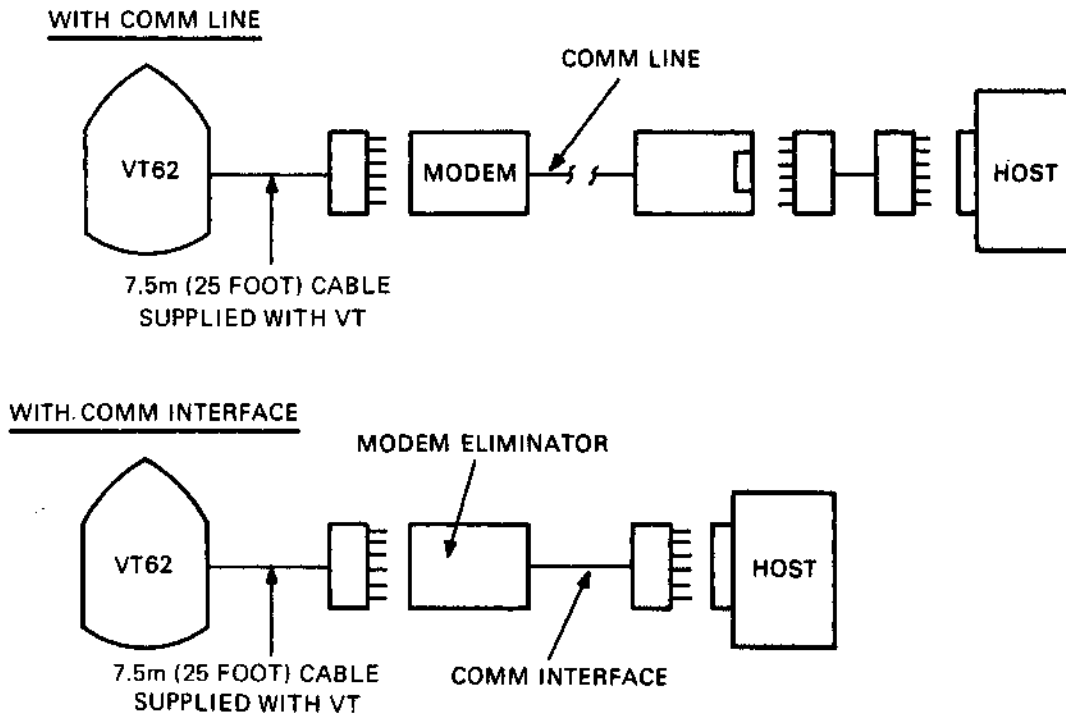

MA-0928

Figure E-1 VT62 Terminal Interface

Your comments and suggestions will help us in our continuous effort to improve the quality and usefulness of our publications.

What is your general reaction to this manual? In your judgment is it complete, accurate, well organized, well written, etc.? Is it easy to use? _____

What features are most useful? _____

What faults or errors have you found in the manual? _____

Does this manual satisfy the need you think it was intended to satisfy? _____

Does it satisfy *your* needs? _____ Why? _____

Please send me the current copy of the *Technical Documentation Catalog*, which contains information on the remainder of DIGITAL's technical documentation.

Name _____	Street _____
Title _____	City _____
Company _____	State/Country _____
Department _____	Zip _____

Additional copies of this document are available from:

Digital Equipment Corporation
444 Whitney Street
Northboro, Ma 01532
Attention: Communications Services (NR2/M15)
Customer Services Section

Order No. EK-VT62-TM-001

Fold Here

Do Not Tear - Fold Here and Staple

**FIRST CLASS
PERMIT NO. 33
MAYNARD, MASS.**

**BUSINESS REPLY MAIL
NO POSTAGE STAMP NECESSARY IF MAILED IN THE UNITED STATES**

Postage will be paid by:

**Digital Equipment Corporation
Technical Documentation Department
Maynard, Massachusetts 01754**

