

digital

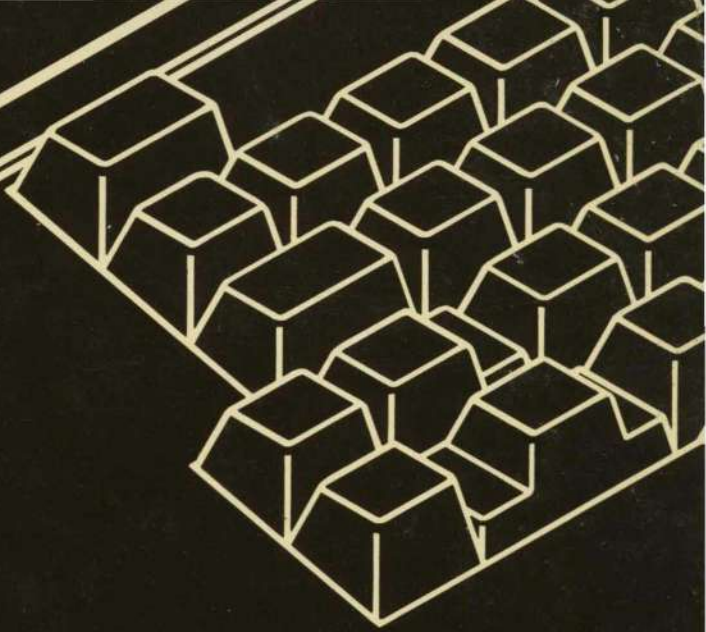

LA
20

USER GUIDE

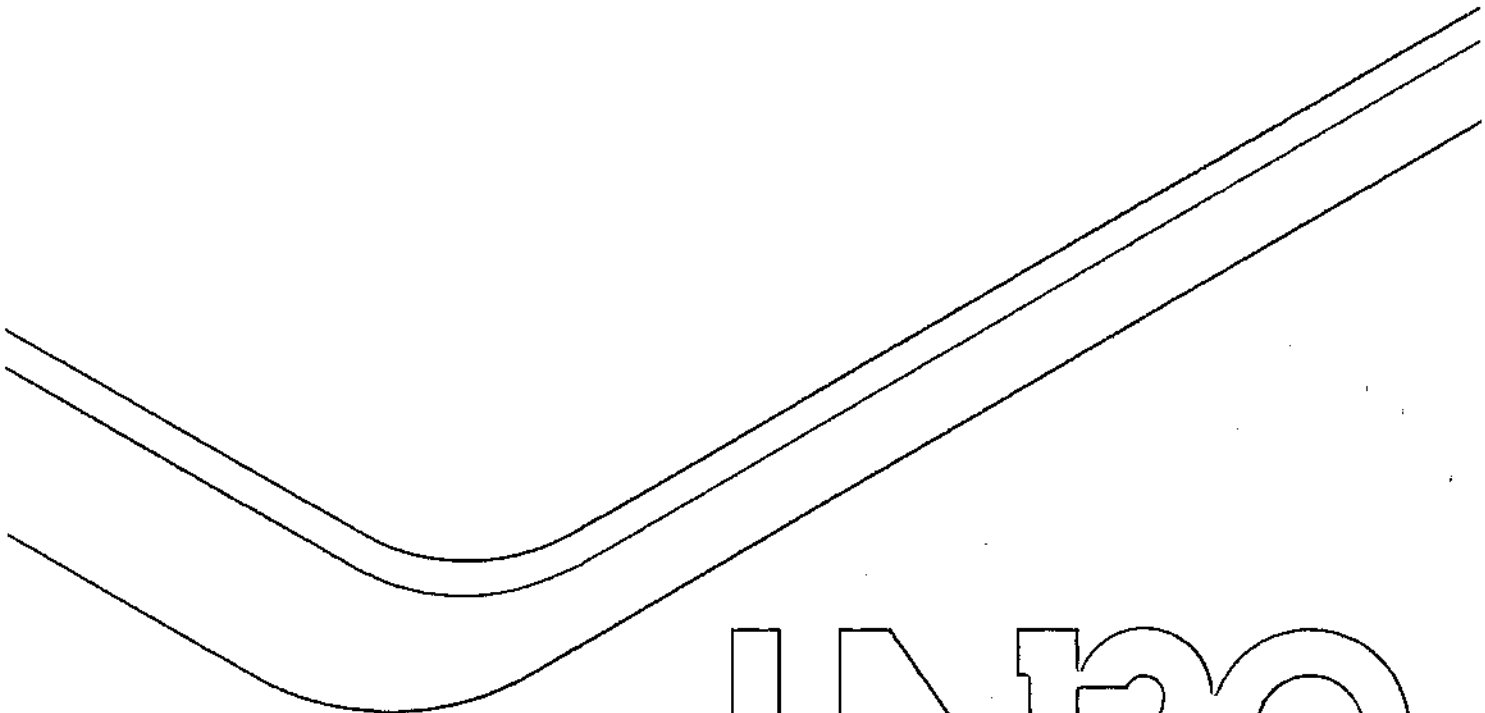

LA120

USER GUIDE

EK-LA120-UG-003

1st Edition, September 1978
2nd Edition, January 1979
3rd Edition, June 1979

Copyright © 1978, 1979 by
Digital Equipment Corporation

The material in this manual is for informational purposes and is subject to change without notice.

Digital Equipment Corporation assumes no responsibility for any errors which may appear in this manual.

Printed in U.S.A.

This document was set on DIGITAL's DECset-8000 computerized typesetting system.

The following are trademarks of Digital Equipment Corporation, Maynard, Massachusetts:

DIGITAL	DECSYSTEM-20	OMNIBUS
DEC	DIBOL	OS/8
PDP	VAX	RSTS
UNIBUS	VMS	RSX
DECsystem-10	MASSBUS	IAS

CONTENTS

INTRODUCTION

CHAPTER 1 OPERATOR INFORMATION

- PART 1 GENERAL USER INFORMATION 1**
 - Operator's Console..... 1
 - Lights 3
 - Numeric Display..... 3
 - Local Control Keys..... 3
 - SET-UP Keys..... 4
 - Control Character Keys..... 5
 - Control Keys..... 6
 - Other Keys..... 6
 - Optional Numeric Keypad 7
 - Power On/Off Switch..... 7
 - Cover Interlock Switch..... 7
 - Paper Adjust Knob..... 8
 - Carriage Adjustment Lever 8
 - Tractor Adjust Knobs 8
 - Alarm Indicators..... 9
 - Testing and Troubleshooting the LA120 10
 - Operator's Troubleshooting Table..... 11
 - Sample LA120 Operators' Card 13

- PART 2 DESCRIPTION OF LA120 FEATURES 15**
 - FORM SET-UP FEATURES 15**
 - Recommended Sequence for Setting Up a New Form..... 15
 - SET-UP Mode..... 18
 - Selecting Lines Per Inch..... 19

Setting Form Length.....	20
Top of Form (TOF).....	21
Top and Bottom Margins and Vertical Tabs	22
Displaying Line Number of a Vertical Tab or Margin	22
Setting Top Vertical Margin	23
Setting Bottom Vertical Margin.....	23
Clearing Vertical Margins.....	24
Setting Single or Multiple Vertical Tabs.....	24
Clearing a Single Vertical Tab	25
Clearing all Vertical Tabs.....	25
Characters Per Inch (Horizontal Pitch).....	25
Horizontal Margins and Tabs	27
Displaying Column Number of a Horizontal Tab or Margin	27
Setting Left and Right Margins.....	28
Clearing Left and Right Margins.....	28
Setting Horizontal Tabs.....	29
Clearing a Single Horizontal Tab	29
Clearing all Horizontal Tabs.....	29
OPERATOR COMFORT FEATURES.....	30
Auto Repeat	30
Last Character View.....	31
Bell Volume.....	31
Key Click	32
COMMUNICATION FEATURES.....	32
Line/Local.....	33
Baud Rate (Speed).....	34
Answerback	36
Transmitting or Printing the Answerback Message	36
Entering/Deleting Answerback Message.....	37
Auto Answerback.....	37
Buffer Control	38
Keyboard and Printer Character Set	39
Printer Character Set.....	39
Auto Disconnect.....	40
Local Echo	41
Auto New Line at Right Margin	41
Auto Line Feed	42
Modem.....	42
Half Duplex (HDX) Initial Calling State.....	43
Secondary Channel.....	43
Parity and Data Bits.....	44
Printer New Line Character	45
XON/XOFF	45
Alternate Keypad Mode	46
Alternate Character Set	47
Selecting Alternate Character Set.....	47
Manually Selecting APL.....	47
Manually Deselecting APL	48
Break Action	48

STORE, RECALL, AND STATUS FEATURES	49
Factory Stored Settings	50
Store/Recall.....	51
Status.....	52
Self-Test Feature.....	53
PART 3 RIBBONS, FORMS, AND IMPRESSIONS	54
Installing Ribbon	54
Print Impression Adjustment	54
Loading Paper/Forms.....	55
Reloading Paper/Forms	56
 CHAPTER 2 INSTALLATION, INTERFACE, AND SPECIFICATIONS	
 INSTALLATION AND CONFIGURATION.....	59
Unpacking and Inspection.....	60
Packing Procedures	61
Voltage Selector Switch	61
Checkout Procedure	62
Answerback Jumper.....	62
INTERFACE INFORMATION	63
EIA Interface.....	63
EIA Cables	63
IMPEDANCE OF TERMINATOR	65
Rise and Fall Times	65
Open Circuit Voltages.....	65
LA120 SPECIFICATIONS	66
 CHAPTER 3 PROGRAMMER INFORMATION	
 GENERAL.....	71
ESCAPE SEQUENCE.....	72
Printer Character Sets.....	73
Optional Character Sets.....	74
Active Column and Active Line.....	74
Linefeed Newline Mode.....	75
Horizontal Pitch	75
Horizontal Margins.....	76
Horizontal Tabs.....	76
Vertical Pitch.....	77
Form Length.....	78
Vertical Margins	78
Vertical Tabs	78
PRODUCT IDENTIFICATION.....	79
Alternate Keypad Mode	79
Control Characters	80
APL Character Set	83
Sample Form SET-UP Using Escape Sequences.....	84
Synchronization.....	84

FILL TIME FORMULAS	85
Horizontal Movement.....	85
Vertical Movement.....	86
Keyboard Operation.....	86
Auto Repeat	86
Printable Character Keys.....	86
Control Character Keys.....	87
Optional Auxiliary Keypad.....	89

CHAPTER 4 COMMUNICATIONS

FULL DUPLEX (FDX).....	93
Full Duplex Connection Requirements	93
Full Duplex Break.....	93
Full Duplex Disconnect Conditions	93
Restraint Mode vs Speed Control Mode	94
HALF DUPLEX (HDX)	94
Initial Direction Determination	94
Reverse Channel.....	95
Modem Delay	95
Request to Send Delay.....	95
Turnaround Characters.....	95
Half Duplex Break.....	95
Loss of Data Set Ready	96
Half Duplex Disconnect	96
MODEM SET-UP FEATURE DESCRIPTION	96
General.....	96
Half Duplex.....	97
EFFECTS OF PAPER OUT	98

CHAPTER 5 OPTIONS

20 mA LA12X-AL.....	101
Installation.....	101
Test After Installation.....	103
LA12X-DL EXPANDED BUFFER	103

CHAPTER 6 SUPPLIES AND ACCESSORIES

GENERAL	107
WARRANTY	Back Cover

INTRODUCTION

Your LA120 DECwriter is designed to work very much like a typewriter. If you can type, this guide will help you learn how to use your LA120.

The LA120 is also easy to integrate with most systems. It is compatible with both EIA and ANSI standards.

Besides the many standard features built into your basic LA120 DECwriter III, there are a number of options and accessories that may be added to your terminal to make it useful in an even wider range of applications.

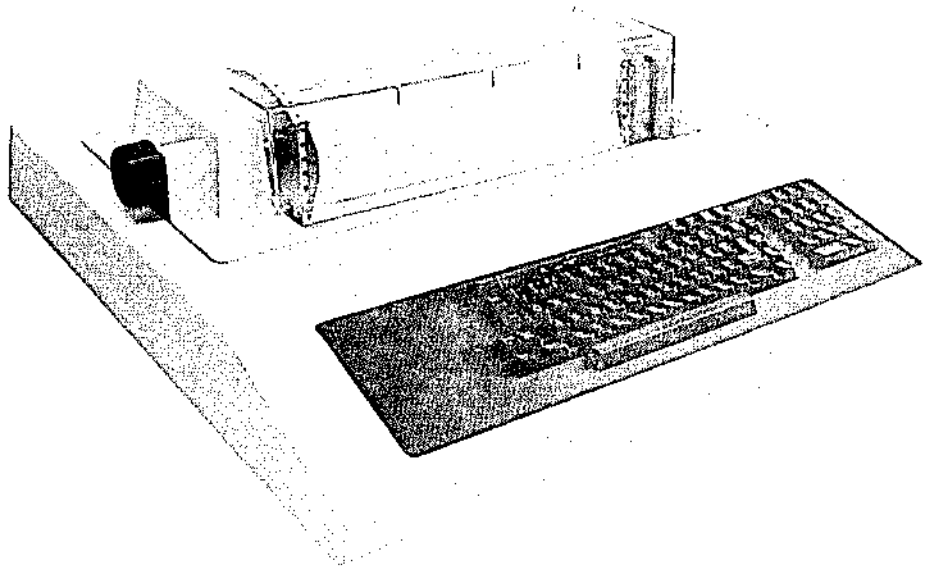

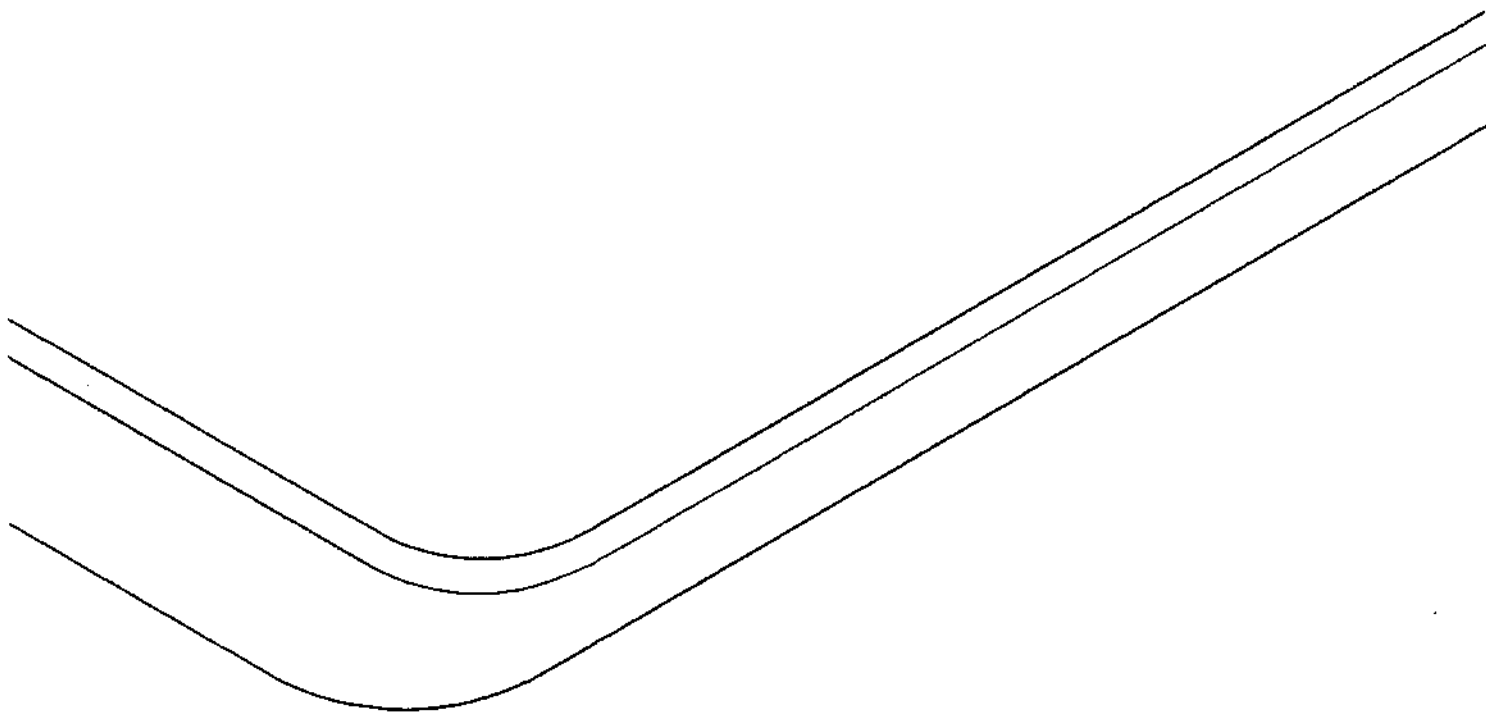

Operator Information

CHAPTER 1

OPERATOR INFORMATION

The LA120 DECwriter III terminal is basically a typewriter with a wide range of features that communicates with a computer.

Part 1 of the operator's chapter is for the general user or user already familiar with the features of a terminal.

- Description of the operator's console
- Description of alarm and bell signals
- Operator Testing and Troubleshooting.
- Summary of LA120 DECwriter III features (Operator Reference Card)

Part 2 is for the new LA120 DECwriter III user. It explains each feature and provides a step-by-step procedure for using the feature.

The features have been grouped to help the user understand when a feature is used:

- Setting up a form
- Operator comfort
- Communication
- Store, Recall, and Status
- Self Test.

Part 3 describes how to load forms, change ribbons, and adjust the print impression.

2 OPERATOR INFORMATION

PART 1 GENERAL USER INFORMATION

OPERATOR'S CONSOLE

The LA120 operator's console contains an office typewriter-style keyboard. The keyboard contains a four digit numeric display and eight indicators. There is provision for an optional, field installable numeric keypad.

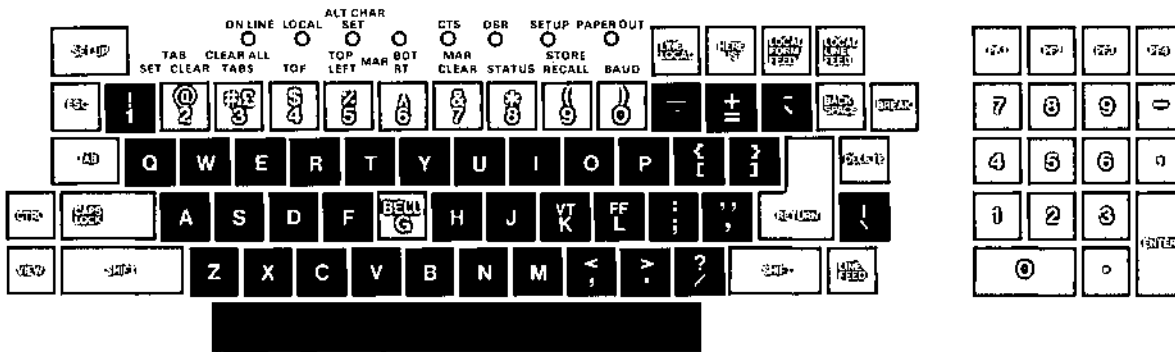

To better understand the LA120 keyboard think of the LA120 as two things. First, it is an input device to a computer; that is, pressing a key sends information (a code) to a computer. Second, it is a printer; information is sent from the computer to the printing portion of the LA120. However, you can set up your system to send information from the keyboard to the printer and computer at the same time.

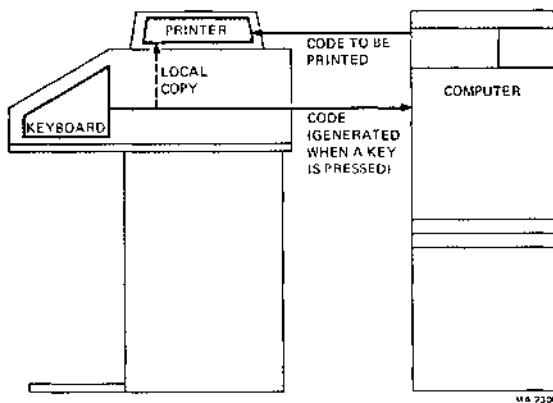

Lights

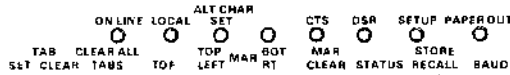

ON LINE

The LA120 is on-line. Data is transmitted and received only while on line.

LOCAL

The LA120 is in local mode. In local, the LA120 operates as a typewriter and does not transmit or receive data.

ALT CHAR SET

An optional alternate character set such as APL is in use.

CTS

Transmission of data is enabled (clear to send).

DSR

The modem is in data mode (data set ready).

SET UP

Flashes to indicate that the LA120 is in SET-UP mode.

PAPER OUT

Flashes to indicate that the printer is not ready due to any of the following conditions.

- Paper out
- Cover open
- Print head jam

Numeric Display

The numeric display indicates the next column number during normal operation. In SET-UP mode the numeric display may also indicate line number, baud rate, form length, etc.

Local Control Keys



LINE/LOCAL

Switches the LA120 from line to local and vice versa as indicated by the **LINE** and **LOCAL** lights.



HERE IS

Transmits the answerback message. This key is not active in SET-UP mode.



LOCAL FORM FEED

Performs a form feed without transmitting a code to the host computer.

4 OPERATOR INFORMATION



LOCAL LINE FEED

Advances the paper one line at a time without transmitting a code to the host computer.

SET-UP Keys



SET-UP

Used to examine or change the LA120 features. For a detailed description refer to the SET-UP mode in Part 2 of this chapter. In SET-UP mode the numeric display indicates line number, baud rate, or form length, etc. Most keys on the keyboard perform a SET-UP command function.

SET-UP command functions for the top row of keys are briefly discussed below:



SET TAB

Sets a horizontal tab stop at the current column. When used with **SHIFT** sets a vertical tab stop at the current line.



CLEAR TAB

Clears the horizontal tab stop at the current column. When used with **SHIFT** clears the vertical tab stop at the current line.



CLEAR ALL

Clears all horizontal and vertical tab stops.



TOP

Shifted or unshifted designates the current paper position as top of form. If top of form is not the same as the top margin, the paper will move to the top margin (first printable line).



TOP/LEFT MAR

Sets left margin at the current column. When used with **SHIFT** sets top margin at the current line.

**BOT/RT MAR**

Sets right margin at the current column. When used with **SHIFT** sets bottom margin at the current line.

**MAR CLEAR**

Clears left and right margins. When used with **SHIFT** clears the top and bottom margins. Left or top margin becomes 1. Right or bottom margin becomes the maximum allowable in the current characters per inch (pitch) or form length.

**STATUS**

Prints status message containing currently selected values of SET-UP features.

**STORE/RECALL**

Recalls the stored SET-UP parameters. When used with **SHIFT** stores the current SET-UP parameters.

**BAUD**

Selects receive and transmit baud rates. When used with **SHIFT** selects split transmit baud rates.

Control Character Keys**ESC**

Generates the code for escape (Chapter 3).

**TAB**

Generates the code for horizontal tab.

SPACE BAR

Generates the code for space.

**BACK SPACE**

Generates the code for backspace.

**DELETE**

Generates the code for delete.

**RETURN**

Generates the code for carriage return or the codes for a carriage return and line feed sequence (in auto line feed mode).

In half duplex, the return key can also generate a turnaround character in addition to its normal code or codes. The turnaround character tells the computer that it's the computer's turn to send data.

**LINE FEED**

Generates the code for line feed.

6 OPERATOR INFORMATION

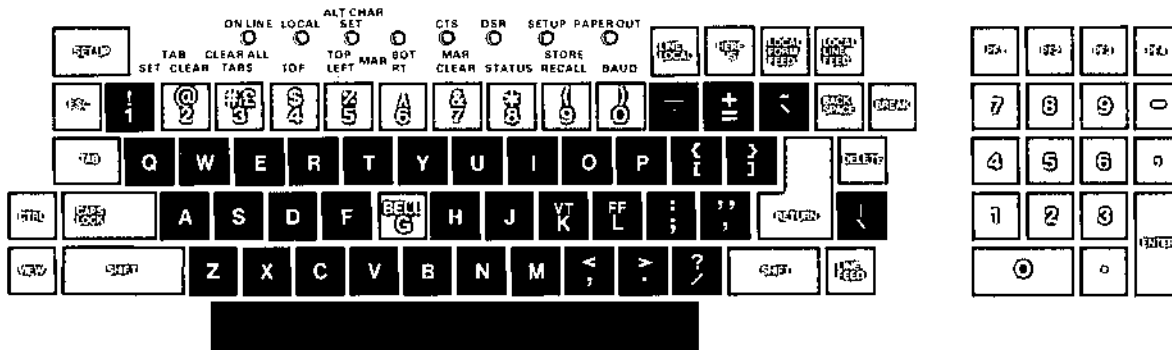

Control Keys

CTRL Key



CTRL

When held down, modifies the function or codes generated by other keys.



Hold **CTRL** down and press **G** to generate the code for the bell. **G** is also used in SET-UP mode to change bell volume.



Hold **CTRL** down and press **K** to generate the code for the vertical tab. **K** is also used in SET-UP mode to turn keyclick on or off.



Hold **CTRL** down and press **L** to generate the code for form feed. **L** is also used in SET-UP mode to select auto line feed.

Other Keys



SHIFT

Functions the same as the shift key on a typewriter. When in SET-UP mode **SHIFT** can also be used with other keys to select LA120 features.

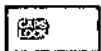

CAPS LOCK

Causes the alphabetic keys to transmit shift (uppercase characters) codes, regardless of the position of the **SHIFT** key. **CAPS LOCK** does not affect numeric or other keys.



BREAK

Causes the LA120 to transmit a short break signal (233 ms). When used with **SHIFT** causes the LA120 to transmit a long break disconnect signal (3.5 seconds).

 **VIEW**

Allows the operator to view the last character printed. For additional detail refer to the last character view feature in Part 2 of this chapter.

Optional Numeric Keypad

The numeric keypad allows numbers to be entered in adding machine fashion. Each number key, the minus key, and the comma key normally generate the same codes as the corresponding unshifted keys on the main keyboard. The **SHIFT** key does not affect the numeric keypad.

In the alternate keypad mode, the keys generate escape sequences which may have special meanings (Chapter 3).

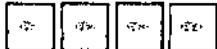

These keys generate escape sequences which may have special meanings (see Programmer's chapter).

 **ENTER**

ENTER normally corresponds to the **RETURN** key. In alternate keypad mode **ENTER** generates an escape sequence which may have a special meaning (Chapter 3).

Power On/Off Switch

The power switch controls power application to the LA120.

Cover Interlock Switch

This switch is a safety feature which prevents operation of the LA120 when the cover is open.

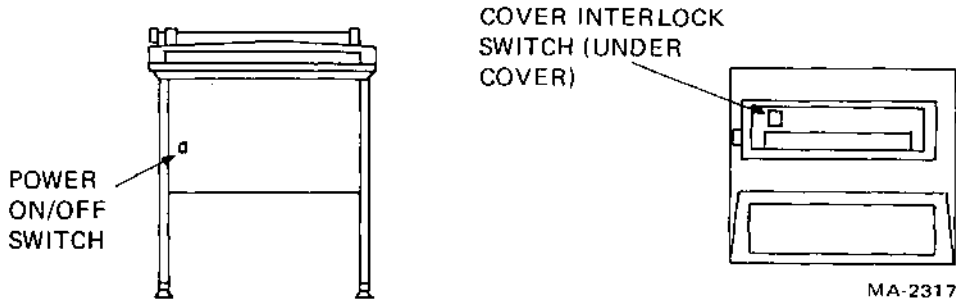

8 OPERATOR INFORMATION

Paper Adjust Knob

Advances the paper 1/12 of an inch at a time. Pressing in and turning the paper adjust knob enables the paper to be rolled freely in either direction and allows precise vertical forms positioning.

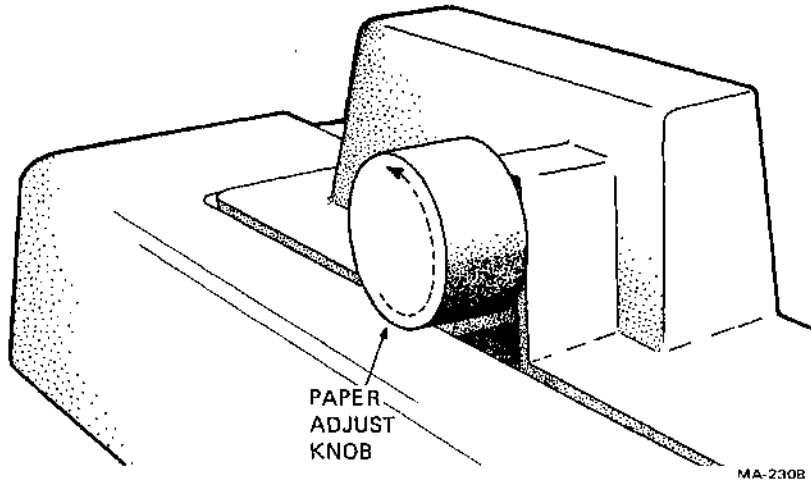

NOTE

This knob should only be used when setting up the form. To advance the paper use LOCAL LINE FEED or LOCAL FORM FEED

Carriage Adjustment Lever

The carriage adjustment lever controls the print head gap for single or multipart forms.

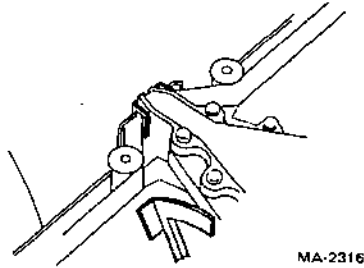

Tractor Adjust Knobs

The tractor adjust knobs allow fine horizontal adjustment of forms.

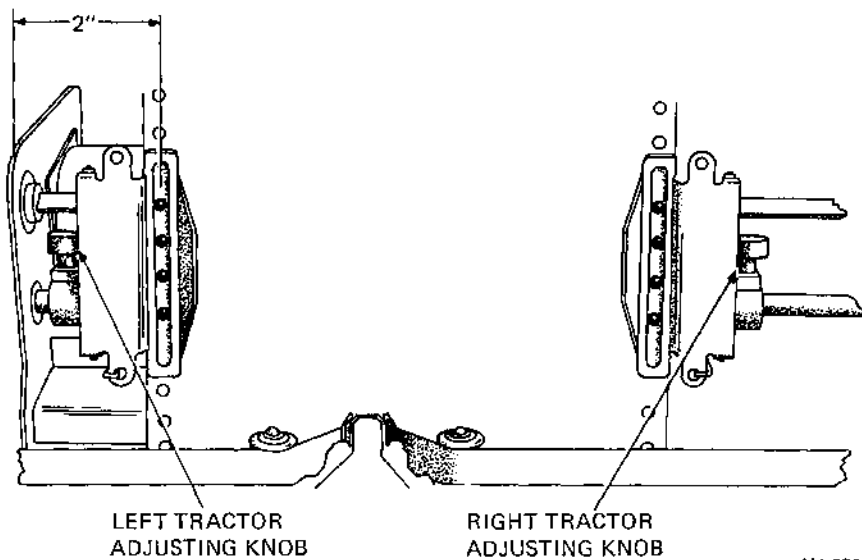

ALARM INDICATORS

The LA120 produces several different alarm and bell signals. The operator should become familiar with these signals to determine the correct response.

BELL and Flashing PAPER OUT Light

These alarm indications will occur under the following conditions.

Cause	Action/Comments
PAPER OUT	Load paper (part 3 of this chapter). Printer will resume normal operation after paper is loaded and cover is closed.

NOTE

When out of paper, bell will turn off after five seconds. If PAPER OUT light continues to flash after cover is closed paper fault still exists.

Head jam	Open top cover and clear obstruction causing head jam (see operator's troubleshooting table). Reload paper by aligning perforation with print head line indicator. Close cover.
Cover open	(Flashing light only) Close cover.

BELL Only

The bell will beep under the following conditions:

Cause	Action/Comments
Low Pitch Bell Tones	
Keyboard buffer overflow	Typing faster than the communication line can handle will cause a buffer overflow. This condition is indicated by a bell tone each time a key is pressed. Under these conditions data will <i>not</i> be lost.
Input buffer overflow	Inputs to the LA120 faster than 1200 baud (without XON/XOFF or its equivalent) can cause a buffer overflow. This condition is indicated by a bell tone, a special symbol printout, and loss of data.

10 OPERATOR INFORMATION

Cause	Action/Comments
High Pitch Bell Tones	
Approaching right margin	One bell tone occurs when the print head moves to within 10 characters of the right margin.
Bell character	Each bell character code received causes a bell tone.
Invalid SET-UP command	One bell tone occurs for each invalid SET-UP command.
Incorrect entry of answer-back message	Attempting to enter more than a 30 character answerback message will cause a bell tone.

TESTING AND TROUBLESHOOTING THE LA120

The LA120 automatically runs several internal tests and displays the error test results in the numeric display.

Display Indicates	Causes	Corrective Action
0 (flashing)	Error at ROM address 0	Call for service
1 (flashing)	Error at ROM address 2048	Call for service
2 (flashing)	Error at ROM address 4096	Call for service
3 (flashing)	Error at ROM address 6144	Call for service
4 (flashing)	Error at ROM address 8192	Call for service
5 (flashing)	Error at ROM address 10240	Call for service
6 (flashing)	Reserved for future options	
7 (flashing)	RAM diagnostic failure	Call for service
8 (flashing)	Microprocessor failure	See note 1
9 (flashing)	Nonvolatile memory failure	See notes
8888 (constant)	Cover open, or paper out indication	Close cover, Reload paper

NOTES

1. Turn LA120 off then back on. If an error indication reappears, record indication and call for service.
2. If the original problem was a flashing 9, check the stored SET-UP feature to ensure that it has not been affected. The self-test is an additional test (Part 2, operator's chapter) which can be initiated by the operator. The test will help determine if the problem is in the printer or in some other portion of the communication system.

If you are unable to turn the printer on or if the printer appears to be faulty, refer to the operator's troubleshooting table. This table describes those things an operator can check prior to requesting service.

Operator's Troubleshooting Table

Symptom	Possible Cause and Corrective Action
LA120 does not turn on when printer power switch set to ON	<p>AC power cord is not plugged into wall outlet or front of printer. Plug in this cord.</p> <p>Power is not coming from the wall outlet. Check outlet with a known working electrical device (such as a lamp). If no power, call your electrician.</p> <p>AC line fuse blown; turn printer off and have the fuse replaced. (See Part 3 for fuse location.)</p>
Characters do not print	<p>Printer out of paper; load paper. (See Part 3 for paper loading.)</p> <p>Printer cover open or ajar. Close cover.</p> <p>Print head too far from paper; readjust print head adjustment lever. (See Part 3 for adjustment.)</p> <p>Data set unplugged; plug it in.</p> <p>Incorrect communication setup.</p>
Light print	<p>Print head too far from paper; adjust print head adjustment lever.</p> <p>Ribbon out of ink; turn ribbon over or replace ribbon. (See Part 3 for ribbon replacement.)</p>
<p>NOTE</p> <p>Turn the ribbon over after 5 to 6 hours of continuous printing. Ribbon can be turned over only once; then it must be replaced.</p>	
Paper does not advance	<p>Paper not loaded properly; check that the tractor covers are closed and the feed holes are properly aligned.</p> <p>Feed holes torn; reload paper. If paper pulls against the tractor pins or bows in the middle, readjust the right tractor.</p>

12 OPERATOR INFORMATION

Symptom

Paper tearing on multipart forms

Possible Cause and Corrective Action

Print head exerting too much pressure on the paper; readjust the print head adjustment lever.

Tractor incorrectly adjusted. If the paper pulls against the tractor pins or bows in the middle, readjust the right tractor.

Paper not straight in printer; re-align paper.

Print head jam or print head does not move

Paper or print head jam; clear jam and perform reloading paper/form procedure in section 3 of this chapter.

No keyboard or printer

Printer cover open or ajar when printer is turned on (normally indicated by flashing 8888 and **PAPER OUT** light); close cover.

Garbled or double characters.

Incorrect communication setup. Ensure that your communication setup is compatible with the equipment at the other end of the line.

Sample LA120 Operators' Card

The operators' card is a summary of all LA120 features, plus the keys used to set the features. Once you become familiar with the operation of the LA120, the card will be a valuable memory aid.

digital DECWRITER III

LA120 OPERATOR REFERENCE CARD

SET-UP

KEY	FUNCTION/COMMENTS
CTRL and SET-UP	Locks LA120 in set-up mode: SET-UP light flashes. To exit set-up mode press SET-UP
SET-UP	Places LA120 in set-up mode while SET-UP is held down. SET-UP light flashes. To exit set-up mode release SET-UP

NOTES:

1. LA120 must be in set-up mode to set the following features.
2. Do not use **SHIFT** unless specified.

FORMS (CONT)

KEY	FUNCTION/COMMENTS																		
H	Horizontal pitch (Characters per inch) NOTE: Changing horizontal pitch clears left and right margins.																		
	<table border="0"> <thead> <tr> <th>DISPLAY</th> <th>PITCH</th> </tr> </thead> <tbody> <tr><td>5</td><td>5.00 CPI</td></tr> <tr><td>6</td><td>6.00 CPI</td></tr> <tr><td>7</td><td>6.60 CPI</td></tr> <tr><td>8</td><td>8.25 CPI</td></tr> <tr><td>10</td><td>10.0 CPI</td></tr> <tr><td>12</td><td>12.0 CPI</td></tr> <tr><td>13</td><td>13.2 CPI</td></tr> <tr><td>16</td><td>16.5 CPI</td></tr> </tbody> </table>	DISPLAY	PITCH	5	5.00 CPI	6	6.00 CPI	7	6.60 CPI	8	8.25 CPI	10	10.0 CPI	12	12.0 CPI	13	13.2 CPI	16	16.5 CPI
DISPLAY	PITCH																		
5	5.00 CPI																		
6	6.00 CPI																		
7	6.60 CPI																		
8	8.25 CPI																		
10	10.0 CPI																		
12	12.0 CPI																		
13	13.2 CPI																		
16	16.5 CPI																		
V	Vertical pitch (Lines per inch) NOTE: Changing vertical pitch clears top and bottom margins.																		
	<table border="0"> <thead> <tr> <th>DISPLAY</th> <th>PITCH</th> </tr> </thead> <tbody> <tr><td>2</td><td>2 LPI</td></tr> <tr><td>3</td><td>3 LPI</td></tr> <tr><td>4</td><td>4 LPI</td></tr> <tr><td>6</td><td>6 LPI</td></tr> <tr><td>8</td><td>8 LPI</td></tr> <tr><td>12</td><td>12 LPI</td></tr> </tbody> </table>	DISPLAY	PITCH	2	2 LPI	3	3 LPI	4	4 LPI	6	6 LPI	8	8 LPI	12	12 LPI				
DISPLAY	PITCH																		
2	2 LPI																		
3	3 LPI																		
4	4 LPI																		
6	6 LPI																		
8	8 LPI																		
12	12 LPI																		

FORMS

KEY	FUNCTION/COMMENTS							
SHIFT	Display current line number Releasing SHIFT returns display to current column number							
1	Set horizontal tab at current column							
SHIFT and 1	Set vertical tab at current line							
2	Clear horizontal tab at current column							
SHIFT and 2	Clear vertical tab at current line							
3	Clear all horizontal tabs							
SHIFT and 3	Clear all vertical tabs							
4 or SHIFT and 4	Establish top of form (TOF)							
5	Set minimum column number (left margin)							
SHIFT and 5	Set minimum line number (top margin)							
6	Set maximum column number (right margin)							
SHIFT and 6	Set maximum line number (bottom margin)							
7	Clear left and right margins							
SHIFT and 7	Clear top and bottom margins							
F	Form Length NOTE: Changing form length clears top and bottom margins and establishes TOF.							
	<table border="0"> <thead> <tr> <th>DISPLAY</th> <th>FUNCTION/COMMENTS</th> </tr> </thead> <tbody> <tr> <td>1</td> <td rowspan="2">} Lines per form</td> </tr> <tr> <td>thru</td> </tr> <tr> <td>168</td> <td></td> </tr> </tbody> </table>	DISPLAY	FUNCTION/COMMENTS	1	} Lines per form	thru	168	
DISPLAY	FUNCTION/COMMENTS							
1	} Lines per form							
thru								
168								

OPERATOR COMFORT

KEY	FUNCTION/COMMENTS
G	Bell volume 0 = Low Volume 1 = High Volume
K	Key click 0 = Off 1 = On
R	Auto repeat 0 = Off 1 = On
Z	Last character view 0 = Manual 1 = Auto

COMMUNICATION

KEY	FUNCTION/COMMENTS
A	Auto answerback 0 = Off 1 = On
B	Buffer control 0 = Small 1 = Large
C	Printer character set 1 = United States 2 = United Kingdom
D	Auto disconnect 0 = Off 1 = On
E	Local echo 0 = Off 1 = On

14 OPERATOR INFORMATION

COMMUNICATION (CONT)

KEY	FUNCTION/COMMENTS
J	Auto new line at right margin 0 = Off 1 = On
L	Auto line feed (Return key) 0 = Off 1 = On
M	Modem 1 = FDX, No Modem 2 = FDX, Modem 3 = HDX, Supervisory 4 = HDX, EOT 5 = HDX, ETX
N	Keyboard and printer character set 1 = United States 2 = United Kingdom
O (letter)	Alternate character set 0 = OFF 1 = ON
P	Parity and data bits

DISPLAY	DATA BITS	PARITY	
		REC	XMT
1	7	IGNORE	MARK
2	7	IGNORE	SPACE
3	7	IGNORE	ODD
4	7	IGNORE	EVEN
5	7	ODD	ODD
6	7	EVEN	EVEN
7	7	NONE	NONE
8	8	NONE	NONE
9	8	ODD	ODD
10	8	EVEN	EVEN

Q	HDX initial calling state 0 = Transmit 1 = Receive
S	Secondary channel

DISPLAY	FDX *	HDX *
	MODE	REV CH.
0	Speed	No
1	Restraint	Yes

* See M Key, Modem

U	Break enabled 0 = No 1 = Yes
W	Printer new line character 1 = None 2 = Line feed (LF) 3 = Return (CR)
X	XON/XOFF 0 = No 1 = Yes
Y	Alternate keypad mode 0 = No 1 = Yes

COMMUNICATION (CONT)

KEY	FUNCTION/COMMENTS	
0 (number)	Selects receive and transmit baud rates and number of stop bits.	
	BAUD RATE (DISPLAYED)	STOP BITS
	50	2
	75	2
	110	2
	134	1
	150	1
	200	1
	300	1
	600	1
	1200	1
	1800	1
	2400	1
	4800	1
	7200	1
	9600	1

SHIFT and **0** Selects split baud rates.
0 selects receive baud rate; **SHIFT** and **0** then offers a choice of three transmit baud rates.

RECEIVE BAUD RATE (NOT DISPLAYED)	TRANSMIT BAUD RATE (DISPLAYED)	TRANSMIT STOP BITS
600	75	2
	150	1
	600	1
1200	75	2
	150	1
	1200	1
2400	300	1
	600	1
	2400	1
4800	300	1
	600	1
	4800	1

STORE RECALL AND STATUS

KEY	FUNCTION/COMMENTS
1 (letter)	Select factory set-up parameters
8	Print status message
9	Recall set-up parameters
SHIFT and 9	Store set-up parameters

SELF TEST

KEY	FUNCTION/COMMENTS
T	Initiate printing self test
SHIFT and >	Initiate non-printing self test

NOTE: Type any character in set-up mode to stop self test

Copyright © 1978 by Digital Equipment Corporation

PRINTED IN U.S.A. EK-LA120-RG-001

PART 2 DESCRIPTION OF LA120 FEATURES

FORM SET-UP FEATURES

When putting a form into a typewriter you must position the form, set margins, set tabs, etc. Setting up your LA120 is very similar. But, in addition to standard typewriter settings, you can select vertical margins, lines per inch, characters per inch, and form lengths. And these additional selections can be permanently stored in the LA120 for future use.

NOTE
Form settings can be automatically loaded into the LA120 by the computer (see programmer's chapter).

To help set up your form you will first be given a recommended SET-UP sequence.

You will then be shown a sample form with a typical SET-UP procedure and sample values. When setting up the sample form for the first time, you may find it necessary to know more about each feature.

The remainder of this section should answer all your questions about a specific feature.

Recommended Sequence for Setting Up a Form

The following sequence is recommended for setting up a form. It is a guide showing all the steps that an operator may perform.

You do not have to use all the steps or features; however, you must follow the order presented.

1. Load paper and ribbon
2. Turn power switch on
3. Enter SET-UP mode
4. Select the number of lines per inch (A)*
5. Enter form length (B)
6. Establish the top of the form (TOF) (C)
7. Set top margin (D)
8. Clear all vertical tabs
9. Set vertical tabs (E)
10. Set bottom margin (F)
11. Select the number of characters per inch (G)
12. Set left margin (H)
13. Clear all horizontal tabs
14. Set horizontal tabs (I)
15. Set right margin (J)
16. If desired, store the above form settings
17. Exit SET-UP mode.









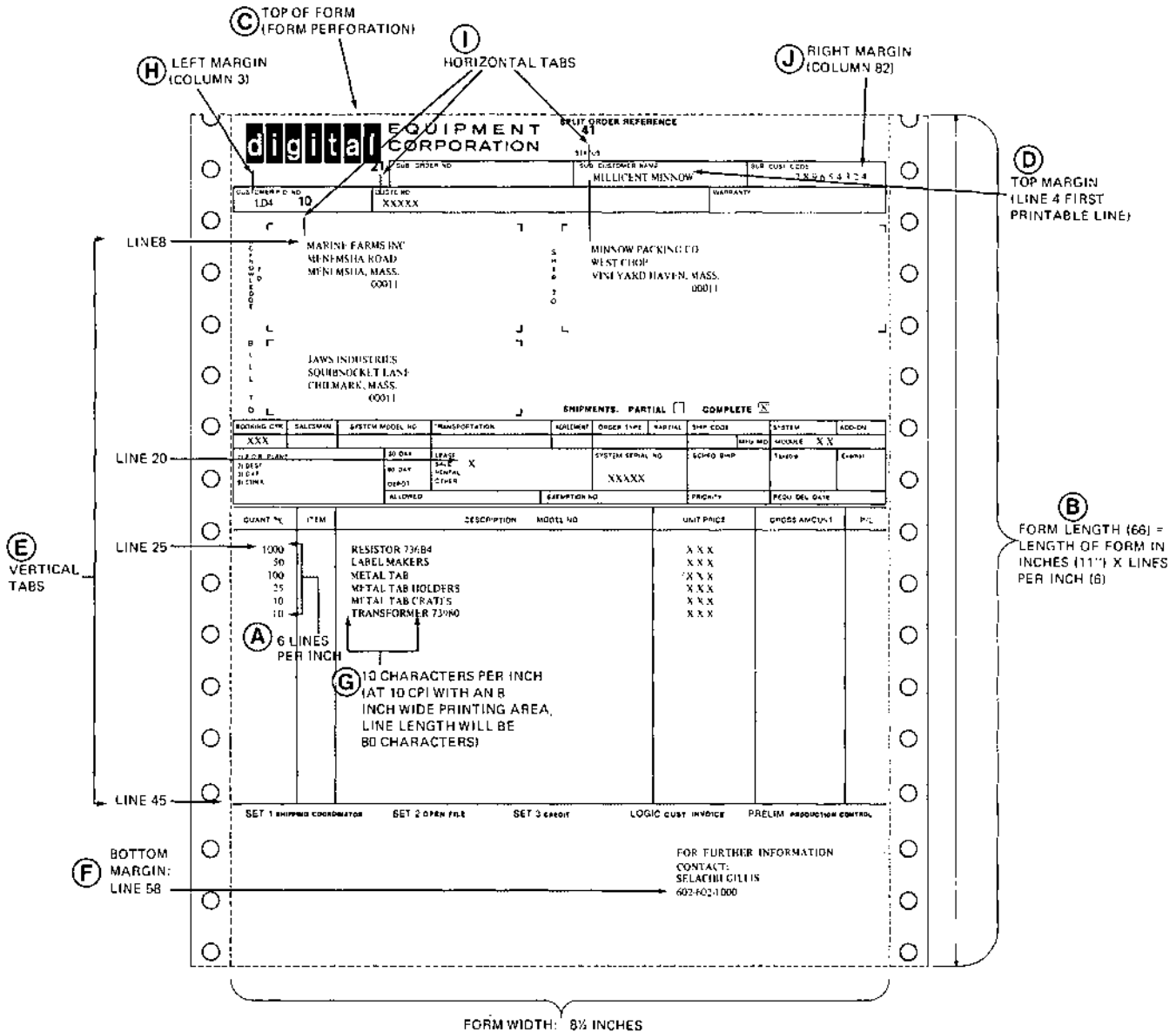









*Circled letters correspond to information on the following pages.

16 OPERATOR INFORMATION

Sample Form SET-UP

The best way to learn to use your LA120 is to set up a sample form. Simply perform the steps in the *procedure* column, and observe the *numeric display* for the desired results. The *keys used* column lists the keys that must be pressed to perform the procedure. When you are finished, your form will have the same margins, tabs., etc., as the sample below.



Procedure		Keys Used	Numeric Display
1. Enter SET-UP		CTRL and SET-UP	Indicates column number
2. Select 6 lines per inch	(A)		6
3. Enter form length; 66 lines	(B)		66
4. Establish top of form at form perforation	(C)		Indicates column
5. Set top margin at line 4	(D)	SHIFT and 	4 *
6. Clear vertical tabs		SHIFT and 	4 *
7. Set vertical tabs at line 8	(E)	SHIFT and 	8 *
8. Set vertical tabs at line 20	(E)	SHIFT and 	20 *
9. Set vertical tabs at line 25	(E)	SHIFT and 	25 *
10. Set vertical tabs at line 45	(E)	SHIFT and 	45 *
11. Set bottom margin at line 58	(F)	SHIFT and 	58 *
12. Select 10 characters per inch	(G)		10
13. Set left margin at column 3	(H)		3
14. Clear horizontal tabs			Indicates column number
15. Set horizontal tabs at column 10	(I)		10
16. Set horizontal tabs at column 21	(I)		21
17. Set horizontal tabs at column 41	(I)		41
18. Set right margin at 82	(J)		82
19. If desired, store SET-UP features		SHIFT and 	(Display goes blank for a few seconds)

NOTES
 1. In steps 5 through 12 use **LOCAL LINE FEED** to advance to desired line.
 2. Press **SHIFT** to display current line number.

NOTE
 Select your operator comfort features and communication features prior to storing your form settings. This will enable you to store all your features at the same time.

* Press **SHIFT** to obtain correct numeric display indication.

SET-UP Mode

LA120 features can be changed only while in SET-UP mode. Normally four steps are required to perform a SET-UP.

1. Enter SET-UP mode
2. Change a feature such as tabs, baud rate, etc.
3. Store the feature if desired (see note)
4. Exit SET-UP mode.

SET-UP mode may be entered while on-line or in local. But, to prevent loss of data, you should enter SET-UP mode only when your system is not sending data, or if it uses XON/XOFF or the restraint signal.

The following procedure describes the two methods of entering and exiting SET-UP mode.

NOTE
Storing enables the selected feature to be permanently stored. For detailed information refer to the Store, Recall, and Status description in this chapter.

Procedure	Indication/Comments
Method 1	
Press and hold CTRL . Then press SET-UP and release both keys. You now change any SET-UP feature.	SET-UP light flashes to indicate you have entered SET-UP mode.
Press SET-UP to exit SET-UP mode.	SET-UP light stops flashing.
Method 2	
Press and hold SET-UP . You must continue to hold the SET-UP key while changing any feature.	SET-UP light flashes to indicate you are in SET-UP mode.
Release SET-UP to exit SET-UP mode.	SET-UP light stops flashing.

Selecting Lines Per Inch

The LA120 offers six different vertical pitch (lines per inch) selections. This feature enables your LA120 to be tailored to accept a large variety of preprinted forms. You can also use these settings to print super and subscripts. To do this select 12 lines per inch, then double-space all lines except those requiring super or subscripts.

NOTE
Changing lines per inch clears top and bottom margins.

To select lines per inch, count the printed lines per inch on your form. Then set the LA120 to the corresponding number.

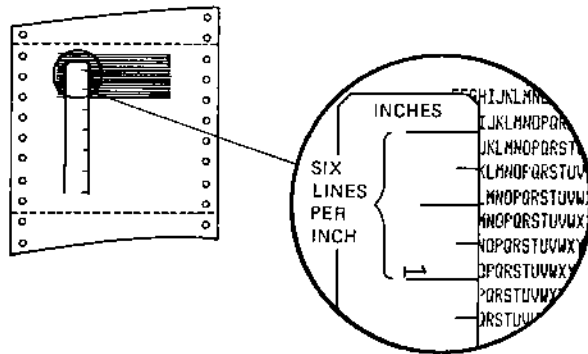

2	3	4	6	8	12
! " # \$ % & ' (! " # \$ % & ' (! " # \$ % & ' (! " # \$ % & ' (! " # \$ % & ' (! " # \$ % & ' (
" # \$ % & ' (" # \$ % & ' (" # \$ % & ' (" # \$ % & ' (" # \$ % & ' (" # \$ % & ' (
" # \$ % & ' (" # \$ % & ' (" # \$ % & ' (" # \$ % & ' (" # \$ % & ' (" # \$ % & ' (

Procedure

Enter SET-UP mode

Press

Press again to change selection

Exit SET-UP mode

Indication/Comments

SET-UP light flashes to indicate you are in SET-UP mode.

Numeric display indicates current line per inch selection.

Numeric Display	Lines per inch
2	2
3	3
4	4
6	6
8	8
12	12

SET-UP light stops flashing.

20 OPERATOR INFORMATION

Setting Form Length

The LA120 measures form length in lines per form. To determine how long your form is, measure the length of form in inches, then multiply the length of form by the lines per inch you have previously selected.

Form length = Length of form in inches × selected number of lines per inch.

Perform the following procedure to enter the number of lines per form. Your choices of form length range from 1 to 168 lines.

NOTE

Changing form length clears top and bottom margins and sets the current line number to 1.

Form Length (Inches)	Lines per Inch Selected					
	2	3	4	6	8	12
3	6	9	12	18	24	36
3.5	7	**	14	21	28	42
4	8	12	16	24	32	48
5.5	11	**	22	33	44	66
6	12	18	24	36	48	72
7	14	21	28	42	56	84
8	16	24	32	48	64	96
8.5	17	**	34	51	68	102
11	22	33	44	66*	88	132
12	24	36	48	72	96	144
14	28	42	56	84	112	168

* 11 inch form at 6 lines per inch = 66 line form length.

** Not recommended.

Procedure

Enter SET-UP mode

Press

Continue to press to change form length

Exit SET-UP mode

Indication/Comments

SET-UP light flashes to indicate that you are in SET-UP mode.

Current form length in lines indicated by numeric display.

Numeric display indicates a new value each time is pressed. Stop when desired number of lines is displayed.

SET-UP light stops flashing.

Top of Form (TOF)

Since the LA120 has no way of knowing where your form starts you must establish the top of the form (TOF). Top of form should be set for all new forms or when changing existing forms.

NOTE

Since the LA120 does not remember the top of form when power is turned off, you can avoid performing the TOF procedure by pressing the local form feed key prior to turning the LA120 off.

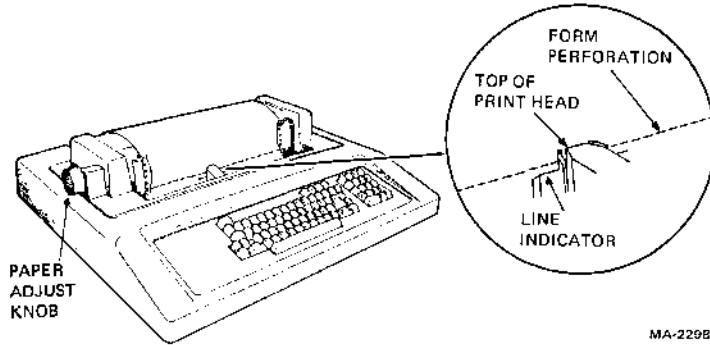

MA-229B

Procedure	Indication/Comments
Enter SET-UP mode	SET-UP light flashes to indicate you are in SET-UP mode.
Use the paper adjust knob to set the form perforation half-way between the line indicator and the top of print head.	Form perforation is lined up with print head.
Press SHIFT and 	Top of form is established. Numeric display indicates line number. If top margin is not line 1, paper moves to top margin.
Exit SET-UP mode	SET-UP light stops flashing.

Top and Bottom Margins and Vertical Tabs

SHIFT, **TOP/MAR**, and **BOT/MAR** are used to establish or change the top and bottom vertical margins. The top margin specifies the first printable line on the form.

SHIFT and **SET TAB** or **CLR TAB** are used to set and clear vertical tabs. **CTRL** and  are used to advance the form to the vertical tab stop.

Tabs can be set or cleared at any time; however, when setting up a new form set tabs after setting the first margin.

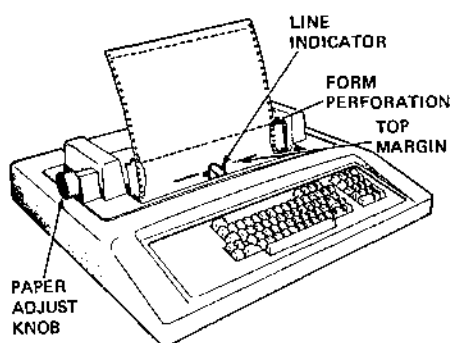

MA-2300

Displaying Line Number of a Vertical Tab or Margin

Procedure

Enter SET-UP mode

To read top margin press **LOCAL FORM FEED**

To read tab press and hold **CTRL** and press 

Repeat above step for each additional tab stop.

To read bottom margin press and hold **SHIFT** and repeatedly press **LINE FEED** while observing numeric display.

Exit SET-UP mode

Indication/Comments

SET-UP light flashes to indicate you are in SET-UP mode.

With **SHIFT** held down numeric display indicates top margin.

Form advances to vertical tab stop. With **SHIFT** held down numeric display will indicate line number of tab stop.

Highest line number displayed before skipping to the next form is the bottom margin.

SET-UP lamp stops flashing.

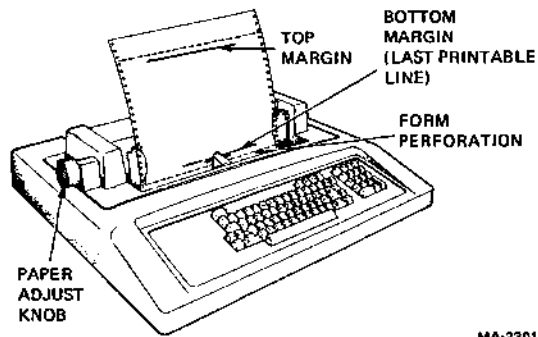

MA-2301

Setting Top Vertical Margin

Procedure

Enter SET-UP mode

Press and hold **SHIFT** and press 

Use LOCAL LINE FEED to advance paper to the desired location of the top margin. If necessary use the paper knob for aligning the form.

Press and hold **SHIFT** and press 

Exit SET-UP mode

Indication/Comments

SET-UP light flashes to indicate you are in SET-UP mode.

Old vertical margins are cleared.

Top margin is set at the current line. With **SHIFT** held down, numeric display indicates line number of margin.

SET-UP light stops flashing.

Setting Bottom Vertical Margin

Procedure

Enter SET-UP mode.

LOCAL LINE FEED advances the paper to the desired location of the bottom margin.

Press and hold **SHIFT** and press 

Exit SET-UP mode

Indication/Comments

SET-UP light flashes to indicate you are in SET-UP mode.

Bottom margin is set. With **SHIFT** held down numeric display indicates line number of margin.

SET-UP light stops flashing.

Clearing Vertical Margins

Procedure	Indication/Comments
Enter SET-UP mode	SET-UP light flashes to indicate you are in SET-UP mode.
Press and hold SHIFT and press 	Top and bottom vertical margins are cleared.
Exit SET-UP mode	SET-UP light stops flashing.

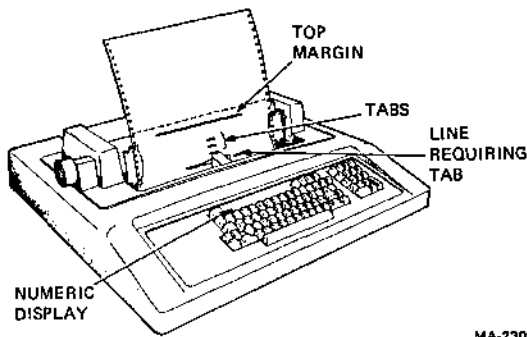



MA-2303

Setting Single or Multiple Vertical Tabs

Procedure	Indication/Comments
Enter SET-UP mode	SET-UP light flashes to indicate you are in SET-UP mode.
LOCAL LINE FEED advances the form to the line requiring a tab.	
Press and hold SHIFT and press 	Tab is set. Numeric display indicates line number of tab.
Repeat the above two steps for each additional tab.	
Exit SET-UP mode	SET-UP light stops flashing.

Clearing a Single Vertical Tab

Procedure	Indication/Comments
Enter SET-UP mode	SET-UP light flashes to indicate you are in SET-UP mode.
Press and hold CTRL and press 	Form advances to vertical tab stop. With SHIFT held down, numeric display indicates line number of tab stop.
Press and hold SHIFT and press 	The vertical tab is cleared.
Exit SET-UP mode	SET-UP light stops flashing.

Clearing all Vertical Tabs

Procedure	Indication/Comments
Enter SET-UP mode	SET-UP light flashes to indicate you are in SET-UP mode.
Press and hold SHIFT and press 	Vertical tabs are cleared.
Exit SET-UP mode	SET-UP light stops flashing.

Characters per Inch (Horizontal Pitch)

NOTE THE LA120 offers eight different character per inch selections.
 Changing characters per inch clears left and right margins.

Characters Per Inch	Example
16.5	0123456789AaBbCcDdEeFfGgHhIiJjKkLlMmNnOoPpQqRrSsTtUuVvWwXxYyZz
13.2	0123456789AaBbCcDdEeFfGgHhIiJjKkLlMmNnOoPpQqRrSsTtUuV
12.0	0123456789AaBbCcDdEeFfGgHhIiJjKkLlMmNnOoPpQqRrSs
10.0	0123456789AaBbCcDdEeFfGgHhIiJjKkLlMmNnOo
8.25	0123456789AaBbCcDdEeFfGgHhIiJjKkL
6.6	0123456789AaBbCcDdEeFfGgHh
6.0	0123456789AaBbCcDdEeFfGg
5.0	0123456789AaBbCcDdEe

This feature saves paper and prints a full 132 columns on 8-1/2 x 11 inch paper that can conveniently be bound into a looseleaf notebook and stored in a standard file cabinet.

The following table lists the number of characters that can be printed on the most commonly used forms.

26 OPERATOR INFORMATION

Typical Form Width* (inches)	Characters per Inch							
	5	6	6.6	8.25	10	12	13.2	16.5
6	30	36	39	49	60	72	79	99
7	35	42	46	57	70	84	92	115
8	40	48	52	66	80**	96	105	132
10	50	60	66	82	100	120	132	165
11	55	66	72	90	110	132	145	181
13.2	66	79	87	108	132	158	174	217

* Form widths listed represent the usable printing area on the most commonly used forms.

** At 10 characters per inch, 80 characters can be printed on an 8-1/2 inch wide form with 1/4 inch margins.

Procedure

Enter SET-UP mode

Press

Press again to change selection

Indication/Comments

SET-UP light flashes to indicate you are in SET-UP mode.

Current character per inch selection appears in numeric display.

Numeric Display Indicates	Characters Per Inch
5	5
6	6
7	6.6
8	8.25
10	10
12	12
13	13.2
16	16.2

Exit SET-UP mode

Numeric display indicates current characters per inch selection. The **SET-UP** light stops flashing.

NOTE

If preprinted forms are used, ensure that characters print within the columns.

Horizontal Margins and Tabs

LEFT MAR and **RT MAR** are used to change the left and right horizontal margins. The left margin specifies the first printable column, the right margin specifies the last printable column.

SET TAB and **CLR TAB** are used to set and clear horizontal tab. Tabs on the LA120 work similar to tabs on a typewriter. When a horizontal tab code is received the print head advances to the next horizontal tab stop. If the tab stop is column 9, printing starts in column 9.

Displaying Column Number of a Horizontal Tab or Margin

Procedure	Indication/Comments
Enter SET-UP mode	SET-UP light flashes to indicate you are in SET-UP mode.
To read left margin number press RETURN key	Numeric display indicates column numbers of left margin.
To read tab press TAB	Print head advances to horizontal tab and numeric display indicates column number of tab.
<i>Repeat above step for each additional tab stop.</i>	
To read right margin, repeatedly press TAB while observing numeric display.	Highest column number displayed is one column greater than right margin. Example: If highest number displayed is 133, right margin is at column 132.
Exit SET-UP mode	SET-UP light stops flashing.

Setting Left and Right Margins

Procedure

Enter SET-UP mode

Press 

To select the left margin position the print head in the desired column as indicated by the numeric display

Press 

To select right margin position the print head in desired column as indicated by numeric display.

Press 

Exit SET-UP mode

NOTE

If desired, perform the tab setting procedure prior to setting the right margin.

Indication/Comments

SET-UP light flashes to indicate you are in SET-UP mode.

Left and right margins are cleared.

Left margin is set. Numeric display indicates column number of margin.

Right margin is set. Numeric display indicates column number of margin.

SET-UP light stops flashing.

Indication/Comments

SET-UP light flashes to indicate you are in SET-UP mode.

Left and right margins are cleared.

SET-UP light stops flashing.

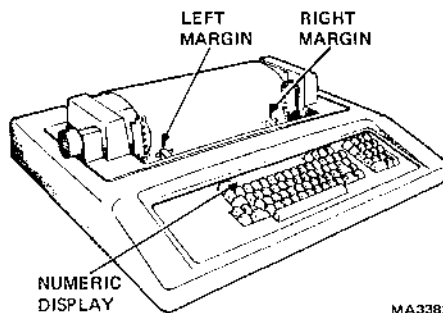

Clearing Left and Right Margins

Procedure

Enter SET-UP mode

Press 

Exit SET-UP mode

Indication/Comments

SET-UP light flashes to indicate you are in SET-UP mode.

Left and right margins are cleared.

SET-UP light stops flashing.

Setting Horizontal Tabs

Procedure

Enter SET-UP mode

If desired clear horizontal tabs.

Move the print head to the desired tab location as indicated by the numeric display.

Press 

For each additional tab move the print head to the desired tab location and repeat the above step.

Exit SET-UP mode

Indication/Comments

SET-UP light flashes to indicate you are in SET-UP mode.

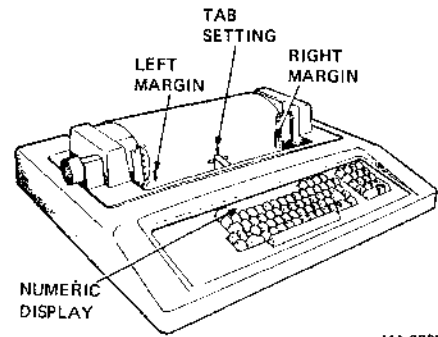

MA-2305

Tab is set. Numeric display indicates column number of tab.

SET-UP light stops flashing.

Clearing a Single Horizontal Tab

Procedure

Enter SET-UP mode

Press TAB to move print head to the desired tab location.

Press 

Exit SET-UP mode

Indication/Comments

SET-UP light flashes to indicate you are in SET-UP mode.

Print head advances to the horizontal tab; numeric display indicates column number of tab.

Horizontal tab is cleared.

SET-UP light stops flashing.

Clearing all Horizontal Tabs

Procedure

Enter SET-UP mode

Press 

Exit SET-UP mode

Indication/Comments

SET-UP light flashes to indicate you are in SET-UP mode.

All horizontal tabs are cleared.

SET-UP light stops flashing.

30 OPERATOR INFORMATION



OPERATOR COMFORT FEATURES

The LA120 contains a number of features designed for operator comfort.

- Auto Repeat—A character is repeated for as long as the key is held down.
- Last Character View—print head moves enabling the last character typed to be seen.
- Bell Volume
- Key Click

Auto Repeat

Auto repeat allows a key to be automatically repeated at the rate of 7.5 characters per second, gradually increasing to 25 characters per second when the key is held down for more than one-half second. Auto repeat affects all printable character keys plus space, backspace, line feed, and delete keys. Auto repeat may be turned totally on or off by using the following procedure.



Procedure	Indication/Comments
Enter SET-UP mode	SET-UP light flashes to indicate you are in SET-UP mode.
Press 	Current selection of auto repeat appears in numeric display.
Press  again to change selection	Numeric display indicates either: 0 = repeat off 1 = auto repeat on.
Exit SET-UP mode	SET-UP light stops flashing.

NOTE

LOCAL LINE FEED *always auto repeats.*



Last Character View

Last character view (LCV) enables the operator to view the last character typed. When typing pauses, the print head moves to the right for a clear view of the last character, then moves back automatically to print. When LCV is not selected the **VIEW** key can be used to view the last character typed. To select LCV perform the following procedure.

Procedure	Indication/Comments
Enter SET-UP mode	SET-UP light flashes to indicate you are in SET-UP mode.
Press 	Current LCV selection appears in numeric display.
Press  again to change selection	Numeric display indicates either: 0 = manual 1 = automatic
Exit SET-UP mode	SET-UP light stops flashing.



Bell Volume

Perform the following procedure to lower or increase the volume of the LA120 bell.

Procedure	Indication/Comments
Enter SET-UP mode	SET-UP light flashes to indicate you are in SET-UP mode
Press 	Current selection of bell volume appears in numeric display.
Press  again to change selection	Numeric display indicates either: 0 = low volume 1 = high volume.
Exit SET-UP mode	SET-UP light stops flashing.

Key Click

The LA120 has a silent keyboard for low-noise environments. But if a keyclick is desired or if you wish to turn the keyclick off, perform the following procedure.

Procedure	Indication/Comments	<i>NOTE</i>
Enter SET-UP mode	SET-UP light flashes to indicate you are in SET-UP mode.	<i>The bell volume feature also changes the volume of the keyclick.</i>
Press 	Current selection of keyclick appears in numeric display.	
Press  again to change selection	Numeric display indicates either: 0 = key click off 1 = key click on.	
Exit SET-UP mode	SET-UP light stops flashing.	

COMMUNICATION FEATURES

To send and receive data the LA120 must be compatible with the equipment and program at the other end. Therefore, communication features are normally preselected and should not be changed unless compatibility is verified. For a more detailed explanation refer to the programmer's and communication sections.

The following features are described in detail and can be selected to match your system requirements.

- Line/Local
- Answerback
- Auto answerback
- Buffer control
- Keyboard and printer character set
- Printer character set
- Auto disconnect
- Local echo
- Auto new line at right margin
- Auto line feed
- Modem
- Half duplex (HDX) initial calling state
- Secondary channel
- Parity and data bits
- Printer new line character
- XON/XOFF
- Alternate keypad mode
- Alternate character set
- Break action

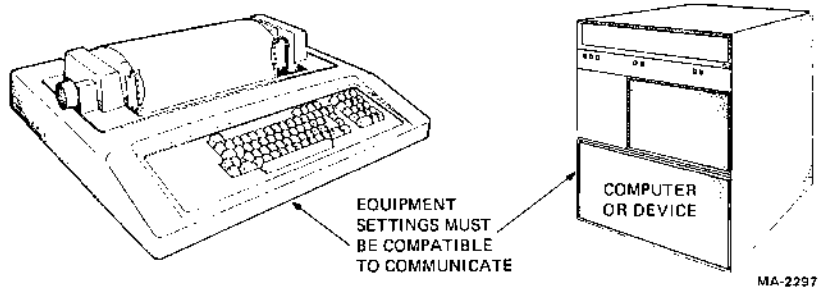

Line/Local

When on-line the LA120 is able to communicate with your system.

When in LOCAL the only communication is between the keyboard and the printer portion of the LA120.

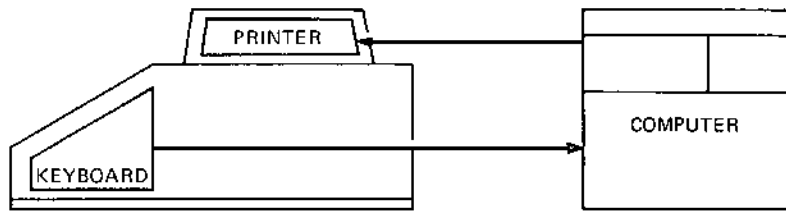

ON LINE



LOCAL

MA3379

Procedure

Observe **ON LINE** and **LOCAL** lights

Press **LINE/LOCAL** to change selection

Indication/Comments

ON LINE or **LOCAL** light is on.

One light goes off; the other goes on.

Baud Rate (Speed)

Baud rate is the speed at which data moves to and from your LA120. And because you must communicate with many systems, a large selection of baud rates are available.

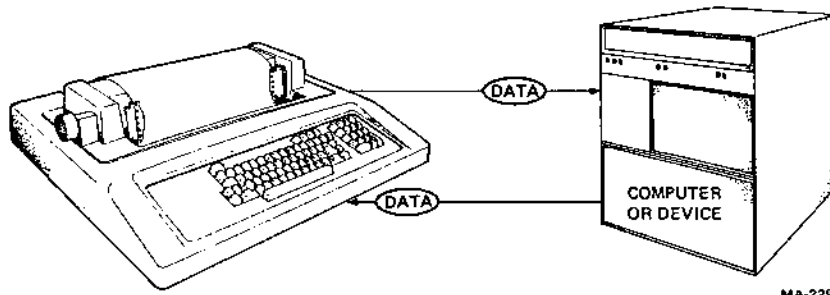

MA-2296

In some systems transmit and receive speeds are different. This is known as the split baud rate. To set the baud rate for your LA120 perform the following.

Procedure

Indication/Comments

Enter SET-UP mode

SET-UP light flashes to indicate you are in SET-UP mode.

Press 

Numeric display indicates baud rate.

Press  again to change transmit and receive baud rate

Baud Rate (Displayed)	Actual Baud Rate	Stop Bits
50	50	2
75	75	2
110	110	2
134	134.5	1
150	150	1
200	200	1
300	300	1
600	600	1
1200	1200	1
1800	1800	1
2400	2400	1
4800	4800	1
7200	7200	1
9600	9600	1

Exit SET-UP mode

SET-UP light stops flashing.

To set the split baud rate for your LA120 perform the following.

Procedure

Enter SET-UP mode

Press  until a receive baud rate of 600, 1200, 2400, or 4800 is displayed.

Press and hold **SHIFT** and press  to display transmit baud rate.

Press and hold **SHIFT** and press  to change transmit baud rate.

Indication/Comments

SET-UP light flashes to indicate you are in SET-UP mode.

Numeric display indicates receive baud rate.

With **SHIFT** held down, numeric display indicates transmit baud rate.

Split Baud Rate Selections

Receive Baud Rate (Not Displayed)	Transmit Baud Rate (Displayed)	Stop Bits
600	75	2
	150	1
	600	1
1200	75	2
	150	1
	1200	1
2400	300	1
	600	1
	2400	1
4800	300	1
	600	1
	4800	1

Exit SET-UP mode

SET-UP light stops flashing.

36 OPERATOR INFORMATION

Answerback

Answerback is a short message of up to 30 characters entered into the LA120 by the operator. The message is transmitted from the LA120 after receiving a command from another device or when the operator initiates the answerback message from the keyboard. The message usually consists of a code that identifies the LA120. This feature is also a means of automatically logging onto a system.

Control codes such as carriage return, line feed, tab, etc., may be part of the answerback message. If a control code is entered one of the following unique characters will be printed.

A jumper internal to the LA120 provides a permanent answerback message that cannot be changed by the operator. The jumper may be removed by the installer after entering and testing the answerback message. See Chapter 2 for additional information.

NOTE

If the answerback jumper is removed the answerback message cannot be altered or erased.

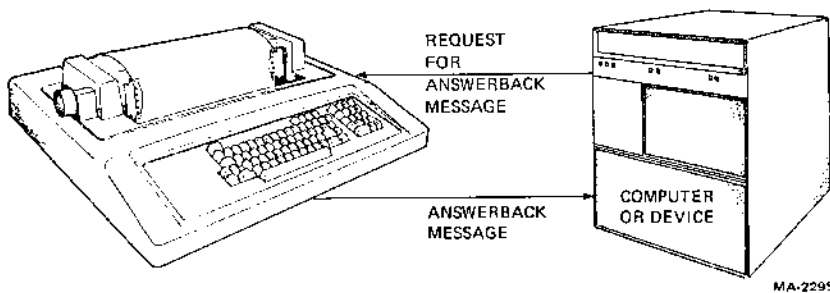

Transmitting or Printing the Answerback Message

Procedure

Press **HERE IS**

Indication/Comments

LA120 transmits the answerback message if on-line. Message prints out if the computer echoes the message or if local echo is selected.

Message prints out if in local.

NOTE

*The LA120 does not respond if **HERE IS** is pressed while in **SET-UP** mode.*

Entering/Deleting Answerback Message

Procedure	Indication/Comments
Press and hold CTRL Then press SET-UP	SET-UP light flashes to indicate you are in SET-UP mode.
Press and hold CTRL . Then press HERE IS and release both keys.	Next character typed starts the answerback.

NOTES

Typing more than 30 characters prevents the answerback message from being permanently stored. If this occurs a bell rings and the entire procedure (starting with CTRL and HERE IS) must be repeated.

If no answerback message is desired, do not type any characters (skip the next step).

Type up to 30 characters to enter answerback message.	Message prints and is temporarily stored. If no characters have been typed the LA120 is set up for no answerback message.
---	--

NOTE

If you do not wish to permanently store the answerback message skip the next step.

Press and hold CTRL and press HERE IS .	Answerback message is permanently stored (numeric display goes blank for a few seconds).
Exit SET-UP mode.	SET-UP light stops flashing.

Auto Answerback

NOTE
*This feature does not affect the **HERE IS** key, or response to ENQ from your system.*

This feature automatically transmits the answerback message the first time the LA120 is transmit-enabled after the modem enters data mode.

Procedure	Indication/Comments
Enter SET-UP mode	SET-UP light flashes to indicate you are in SET-UP mode.
Press <input type="checkbox"/>	Current selection of auto answerback appears in numeric display.
Press <input type="checkbox"/> again to change selection	Numeric display indicates either: 0 = auto answerback feature is turned off 1 = auto answerback feature is turned on.
Exit SET-UP mode	SET-UP light stops flashing.

38 OPERATOR INFORMATION

Buffer Control

Typically a printer receives a series of characters, temporarily stores them in a buffer, and then prints them one at a time.

During synchronization, the LA120 constantly monitors the number of characters stored in its input buffer. When the number of characters exceeds a "high water mark," the LA120 signals the data source to temporarily pause. Meanwhile, the printer continues to take characters out of the input buffer. When the number of characters remaining is less than a "low water mark," the LA120 signals that transmission may resume. The values used for the high and low water marks are determined by selecting a small or large buffer. For additional information see Chapter 3.

When the LA120 is switched off-line, it may continue to print several lines of data. This is a normal condition when using the large buffer.

Summary Table

Control	Comment
Small buffer	Recommended when terminal is used interactively.
Large buffer	Recommended when LA120 is used primarily as a printer.

Procedure

Enter SET-UP mode

Press

Press again to change selection

Exit SET-UP mode

Indication/Comments

SET-UP light flashes to indicate you are in SET-UP mode.

Current selection of buffer size appears in numeric display.

Numeric display indicates either:



0 = small buffer

1 = large buffer.

SET-UP light stops flashing.

Keyboard and Printer Character Set

This feature enables the LA120 keyboard and printer to function in a specific national language. The standard choices are United States and United Kingdom. Finnish, Swedish, Norwegian/Danish, German, and French are optional and require different keycaps.

Procedure	Indication/Comments											
Enter SET-UP mode	SET-UP light flashes to indicate you are in SET-UP mode.											
Press 	Current keyboard and printer character set appears in numeric display.											
Press  again to change selection	Numeric display indicates:											
	<table border="0" style="margin-left: 20px;"> <tr> <td>1 United States</td> <td rowspan="2" style="font-size: 2em; vertical-align: middle;">}</td> <td rowspan="2">Standard</td> </tr> <tr> <td>2 United Kingdom</td> </tr> <tr> <td>3 Finland</td> <td rowspan="5" style="font-size: 2em; vertical-align: middle;">}</td> <td rowspan="5">Optional</td> </tr> <tr> <td>4 Sweden</td> </tr> <tr> <td>5 Norway/Denmark</td> </tr> <tr> <td>6 Germany</td> </tr> <tr> <td>7 France</td> </tr> </table>	1 United States	}	Standard	2 United Kingdom	3 Finland	}	Optional	4 Sweden	5 Norway/Denmark	6 Germany	7 France
1 United States	}	Standard										
2 United Kingdom												
3 Finland	}	Optional										
4 Sweden												
5 Norway/Denmark												
6 Germany												
7 France												
Exit SET-UP mode	SET-UP light stops flashing.											

Printer Character Set

This feature enables you to receive messages in a specific national language that is different from your keyboard. These character sets are:

- | | | |
|----------------|---|----------|
| United States | } | Standard |
| United Kingdom | | |
| Finland | } | Optional |
| Sweden | | |
| Norway/Denmark | | |
| Germany | | |
| France | | |

For example, you are an international firm and your daily business over the LA120 is conducted in English. A Swedish customer decides to send an order in Swedish. You would select character set 4 enabling you to receive and print the order in Swedish.

NOTE
This feature has no effect on the keyboard.

40 OPERATOR INFORMATION

Procedure

Enter SET-UP mode

Press

Press again to change selection

Exit SET-UP mode

Indication/Comments

SET-UP light flashes to indicate you are in SET-UP mode.

Current printer character set appears in numeric display.

Numeric display indicates:

- | | | |
|------------------|---|----------|
| 1 United States | } | Standard |
| 2 United Kingdom | | |
| 3 Finland | } | Optional |
| 4 Sweden | | |
| 5 Norway/Denmark | | |
| 6 Germany | | |
| 7 France | | |

SET-UP light stops flashing.

Auto Disconnect

Auto disconnect hangs up the phone when the LA120 runs out of paper, the cover opens, or the print head jams. This feature is most useful if your terminal is unattended.

There are two additional ways to cause an auto disconnect:

- Manually by pressing and holding **CTRL** and pressing
- Remotely by receiving EOT (end of transmission) from your computer.

When auto disconnect is off, data terminal ready is always asserted. See Chapter 4 for additional information.

NOTE

If auto disconnect is not used it must be set to off.

Procedure

Enter SET-UP mode

Press

Press again to change selection

Exit SET-UP mode

Indication/Comments

SET-UP light flashes to indicate you are in SET-UP mode.

Current selection of auto disconnect appears in numeric display.

Numeric display indicates either:

0 = off

1 = on.

SET-UP light stops flashing.

Local Echo

NOTES
 If your computer does not echo characters, local echo feature should be selected. ENQ characters are never echoed.

Selecting local echo causes each typed character to be transmitted *and* printed. If local echo is not selected, pressing a key will only transmit the character.

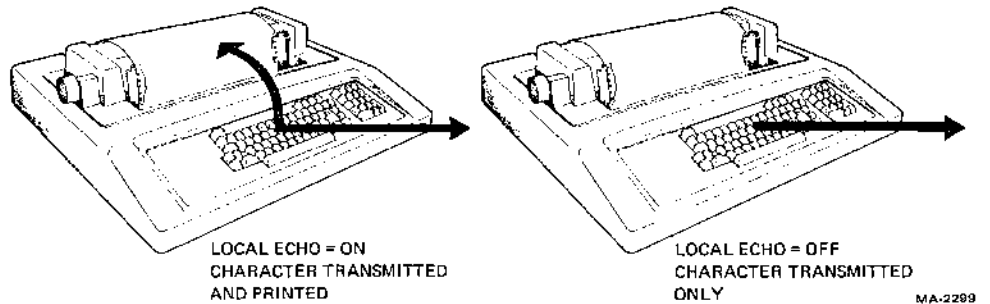

Procedure

Enter SET-UP mode

Press

Press again to change selection.

Exit SET-UP mode

Indication/Comments

SET-UP light flashes to indicate you are in SET-UP mode.

Current selection of local echo appears in numeric display.

Numeric display indicates either:
 0 = off
 1 = on.

SET-UP light stops flashing.

Auto New Line at Right Margin

This feature when selected causes the LA120 to generate an internal carriage return and line feed if the incoming message tries to print beyond the right margin.

This is extremely useful in a message network where the accidental omission of a carriage return code results in the partial loss of the message.

If not selected, printing beyond the right margin sounds the bell and characters are lost.

Procedure

Enter SET-UP mode

Press

Press again to change selection

Exit SET-UP mode

Indication/Comments

SET-UP light flashes to indicate you are in SET-UP mode.

Current selection of auto new line appears in numeric display.

Numeric display indicates either:
 0 = auto new line feature off
 1 = auto new line feature on.

SET-UP light stops flashing.

Auto Line Feed



The auto line feed feature enables the **RETURN** key on the LA120 to function like the return key on a standard electric typewriter. When the auto line feed feature is turned on, pressing the **RETURN** key generates the carriage return (CR) and line feed (LF) codes. When the auto line feed feature is disabled, the **RETURN** key generates only the carriage return (CR) code.

NOTES

If a double line feed occurs, turn this feature off since the computer is already performing this function automatically.

In coded control half duplex, the RETURN key transmits the turnaround character automatically after transmitting its normal code or codes.

The ENTER key on the numeric keypad is also affected by this feature.

Procedure	Indication/Comments
Enter SET-UP mode	SET-UP light flashes to indicate you are in SET-UP mode.
Press 	Current selection of auto line feed appears in numeric display.
Press  again to change selection	Numeric display indicates either: 0 = off 1 = on.
Exit SET-UP mode	SET-UP light stops flashing.



Modem

This feature enables selection of a protocol that matches your communication requirements (see Chapter 4).

Refer to the half duplex initial calling state and the secondary channel procedures for related modem SET-UP features.

Selectable Protocols

- Full duplex without EIA control (no modem)
- Full duplex with EIA control (modem)
- Half duplex with supervisory control
- Half duplex with coded control (EOT turnaround)
- Half duplex with coded control (ETX) turnaround)

Procedure	Indication/Comments
Enter SET-UP mode	SET-UP light flashes to indicate you are in SET-UP mode.
Press 	Current selection of modem protocol appears in numeric display.
Press  again to change selection	Numeric display indicates: 1 FDX, no modem 2 FDX, modem 3 HDX, supervisory 4 HDX, EOT 5 HDX, ETX
Exit SET-UP mode	SET-UP light stops flashing.

Half Duplex (HDX) Initial Calling State

When the LA120 initiates communication with a computer, the condition of the HDX initial calling state is checked. The condition of this state determines if the LA120 starts receiving or transmitting. This feature can only be used if choice 4 or 5 of the modem procedure has been selected.

Procedure	Indication/Comments
Enter SET-UP mode	SET-UP light flashes to indicate you are in SET-UP mode.
Press <input type="button" value="0"/>	Current selection of HDX initial calling state appears in numeric display.
Press <input type="button" value="1"/> again to change selection	Numeric display indicates either: 0 = transmit 1 = receive.
Exit SET-UP mode	SET-UP light stops flashing.

Secondary Channel

This feature has two meanings. First, if modem choices 1 or 2 (full duplex) were selected, the secondary channel feature can be used to indicate the restraint mode.

The second meaning applies when half duplex modem choices 4 or 5 are selected. The secondary channel feature can now be used to indicate the presence of a secondary (reverse) channel.

Procedure	Indication/Comments
Enter SET-UP mode	SET-UP light flashes to indicate you are in SET-UP mode.
Press <input type="button" value="\$"/>	Current selection of secondary channel appears in numeric display.
Press <input type="button" value="\$"/> again to change selection	

Numeric Display Indicates	Modem 1 or 2 Selected	Modem 4 or 5 Selected
0	Speed control mode	Secondary channel – no
1	Restraint mode	Secondary channel – yes

Exit SET-UP mode	SET-UP light stops flashing.
------------------	-------------------------------------

Parity and Data Bits

Parity enables data errors to be monitored and thereby verifies correct data. If an error in transmission occurs, the LA120 detects it and prints a symbol (⌘).

In addition to parity, this feature enables selection of seven or eight data bits.

Procedure

Enter SET-UP mode

Press 

Press  again to change parity and data bit selection

Indication/Comments

SET-UP light flashes to indicate you are in SET-UP mode.

Current selection of parity and data bits appears in numeric display.

Numeric Display Indicates	Data Bits	Parity Rec	Parity Transmit
1	7	Ignore	Mark
2	7	Ignore	Space
3	7	Ignore	Odd
4	7	Ignore	Even
5	7	Odd	Odd
6	7	Even	Even
7	7	None	None
8	8	None	None
9	8	Odd	Odd
10	8	Even	Even

Exit SET-UP mode

SET-UP light stops flashing.

NOTE

When eight data bits are selected the LA120 ignores the eighth data bit on characters received and transmits all characters with the eighth data bit set to zero.

Printer New Line Character

This feature controls how the LA120 responds to line feed or carriage return codes it receives. You can select three different ways for the LA120 to respond as described in the following table.

NOTE
In choice 2 the LA120 also performs a carriage return when it receives vertical tab and form feed characters.

Selections Indicated by Numeric Display	Carriage Return Code Received	Line Feed Code Received
1	LA120 performs carriage return.	LA120 performs line feed.
2	LA120 performs carriage return.	LA120 performs carriage return and line feed.
3	LA120 performs carriage return and line feed.	LA120 performs line feed.

Procedure

Enter SET-UP mode

Press

Press again to change selection

Exit SET-UP mode

Indication/Comments

SET-UP light flashes to indicate you are in SET-UP mode.

Current selection of printer new line character appears in numeric display.

Numeric display indicates either:

1. No new line character
2. Line feed new line mode
3. Carriage return new line mode

SET-UP light stops flashing.

XON/XOFF

NOTES
XON/XOFF should only be changed when your system is not sending data.

The LA120 is capable of automatically generating the XON (DC1) and XOFF (DC3) codes. XOFF stops transmission of data from the computer to the terminal, while XON resumes transmission.

For related information refer to the buffer control procedure.

If the terminal does not print on-line it may be necessary to type CTRL-Q.

Procedure

Enter SET-UP mode

Press

Press again to change selection

Exit SET-UP mode

Indication/Comments

SET-UP light flashes to indicate you are in SET-UP mode.

Current selection of XON/XOFF appears in numeric display.

Numeric display indicates either:

- 0 = XON/XOFF is disabled
- 1 = XON/OFF is enabled.

SET-UP light stops flashing.

Alternate Keypad Mode

This procedure enables the optional numeric keypad to be used in two ways: to generate character codes, or to generate escape sequences. The following table describes the characters and escape sequences generated by the 18 keys on the keypad.

NOTE

When in alternate keypad mode and local the numeric keypad cannot be used to print characters.

Character or Escape Sequence Transmitted		
Numeric Keypad Key	Normal Keypad Mode	Alternate Keypad Mode
PF1	ESC O P	ESC O P
PF2	ESC O Q	ESC O Q
PF3	ESC O R	ESC O R
PF4	ESC O S	ESC O S
ENTER	Same as RETURN key	ESC O M
, (comma)	, (comma)	ESC O I
— (dash)	— (dash)	ESC O m
. (period)	. (period)	ESC O n
0	0	ESC O p
1	1	ESC O q
2	2	ESC O r
3	3	ESC O s
4	4	ESC O t
5	5	ESC O u
6	6	ESC O v
7	7	ESC O w
8	8	ESC O x
9	9	ESC O y

Procedure

Enter SET-UP mode

Press

Press again to change selection

Exit SET-UP mode

Indication/Comments

SET-UP light flashes to indicate you are in SET-UP mode.

Current selection of alternate keypad mode appears in numeric display.

Numeric display indicates either:

0 = normal keypad mode

1 = alternate keypad mode.

SET-UP light stops flashing.

Alternate Character Set

NOTES
The APL character set is part of the National Character Set option.

When the LA120 is printing APL characters the ALT CHAR SET light is on.

The alternate character set feature is used only with the APL character set (a programmer's language, see note 1). To use the APL character set, first set the alternate character set feature to on (1). Then the LA120 can manually or automatically switch (under computer control) between the selected printer character set and the APL character set. When switched to APL, data from your computer prints as APL characters. (For additional information see APL character set description in the programmer's chapter.)

Selecting Alternate Character Set

If in SET-UP mode with APL selected, the status message and self-test will be printed out using APL symbols.

Procedure

Enter SET-UP mode

NOTE

When using the APL keyboard the keyboard character set should be set to 1 or 2. (See the keyboard and printer character set procedure in this chapter.) The printer character set can be set to select any national language.

Press the letter 0

Press 0 again to change selection

Exit SET-UP mode

Indication/Comments

SET-UP light flashes to indicate you are in SET-UP mode.

Current selection of alternate character set appears in numeric display.

Numeric display indicates either:
 0 = shift out disabled (APL cannot be selected)
 1 = shift out enabled (APL can be selected)

SET-UP light stops flashing.

Manually Selecting APL

NOTE
Alternate character set must be set to 1 to select APL.

Procedure

Enter LOCAL by pressing LINE/LOCAL

Press CTRL N

Press LINE/LOCAL for LINE

Indication/Comments

LOCAL light goes on indicating you are in LOCAL.

APL is selected.

LA120 is now on-line and can send and receive APL characters.

Manually Deselecting APL



Procedure	Indication/Comments
Enter LOCAL by pressing LINE/LOCAL.	LOCAL light goes on indicating you are in LOCAL.
Press CTRL  (letter)	APL is deselected.
Press LINE/LOCAL for LINE	LA120 is on-line and APL is no longer selected.

Break Action

Enabling (turning on) break action causes the LA120 to automatically send a break signal in response to paper out, cover open, head jam, or pressing BREAK.

If your communication system is set up to recognize break, sending the break signal may hang up the phone. The phone can also be hung up if auto disconnect is enabled. (See the auto disconnect description in this chapter.)

With break action disabled paper out, cover open, head jam, or pressing BREAK will not generate a break signal. (For additional information, see the break key description in the programmer's chapter.)

Procedure	Indication/Comments
Enter SET-UP mode	SET-UP light flashes to indicate you are in SET-UP mode.
Press 	Current selection of break action appears in numeric display.
Press  again to change selection	Numeric display indicates either: 0 = disabled 1 = enabled.
Exit SET-UP mode	SET-UP light stops flashing.

STORE, RECALL, AND STATUS FEATURES

The LA120 contains one operating (temporary) memory and two permanent memories. One permanent memory is for user information, the other contains the original factory settings.

Temporary memory is like the memory in most calculators. When power is turned off information is lost. Your LA120 operates from this memory. When power is turned on, information in the user permanent memory is loaded into the operating memory. The LA120 then uses this information for its operation. When new SET-UP information is generated it is loaded directly into the operating memory. To place new SET-UPS in the user's permanent memory the store procedure must be performed. To read the contents of the operating memory simply perform the status procedure.

User permanent memory stores important or commonly used SET-UP information. This memory is read/write like the tape in your tape recorder. That is, new information can be stored or old information changed. To store or recall information, see STORE/RECALL procedure.

NOTE

No power or batteries are required to retain information in permanent memories.

Factory permanent memory is set at the factory with typical SET-UP information. This memory is read-only; it cannot be changed or erased. It is like the record on your record player. To use the factory setting perform the factory stored settings procedure.

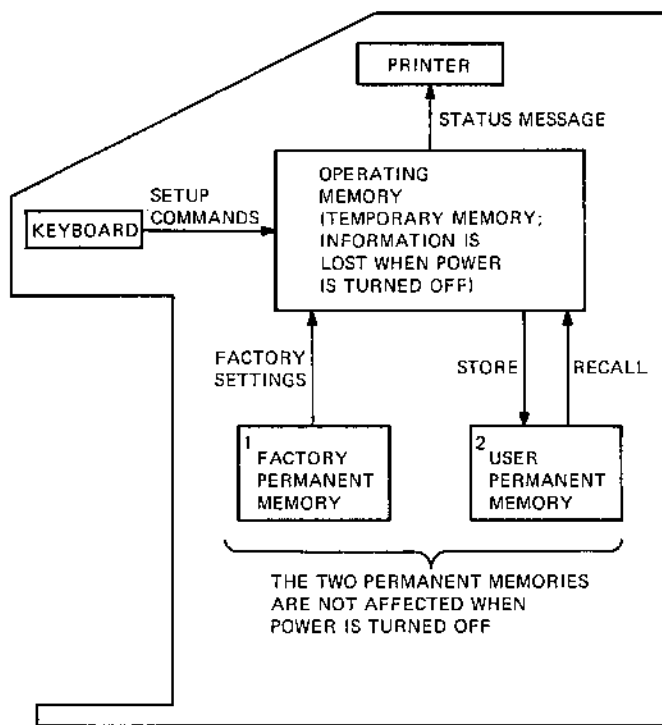

Factory Stored Settings

This procedure enables you to change the state of all LA120 settings to the values originally set at the factory. This is useful if you have no special setting requirements, or if you desire a specific starting point for your SET-UP. The original factory settings are:

Parameter	Setting
Horizontal tab stops *	1, 9, 17, 25, 33, 41, 49, 57, 65, 73, 81, 89, 97, 105, 113, 121, 129, 137, 145, 153, 161, 169, 177, 185, 193, 201, 209, 217
Vertical tab stops *	1, 9, 17, 25, 33, 41, 49, 57, 65, 73, 81, 89, 97, 105, 113, 121, 129, 137, 145, 153, 161
Left margin	1
Right margin	132
Top margin	1
Bottom margin	66
Line/local status	On-line

Parameter	Setting	Parameter	Setting
REC	1200	M	1
XMT	1200	N	1
A	0	O	1
B	1	P	1
C	1	Q	0
D	1	R	1
E	0	S	0
F	66	U	1
G	1	V	6
H	10	W	1
J	1	X	1
K	0	Y	0
L	0	Z	1

* Tab stops are located every eight columns or lines.

Procedure	Indication/Comments
Enter SET-UP mode	SET-UP light flashes to indicate you are in SET-UP mode.
Press the letter <input type="text" value="P"/>	LA120 operating memory is loaded with factory stored settings.
Exit SET-UP mode	SET-UP light stops flashing.

Store/Recall

Setting up your LA120 is normally a one-time job. This is due to a unique feature that stores all your settings in the user permanent memory; that is, the LA120 can be turned off without losing the following settings:

- | | |
|-----------------------|------------------------------------|
| Line/local state | Horizontal pitch |
| Horizontal tab stops | Auto new line |
| Vertical tab stops | Key click |
| Left margin | Auto line feed |
| Right margin | Modem |
| Top margin | Keyboard and printer character set |
| Bottom margin | HDX initial calling state |
| Line/local status | Auto repeat |
| Baud rate | Secondary channel |
| Answerback | XON/XOFF |
| Buffer control | Alternate keypad mode |
| Printer character set | Auto view |
| Auto disconnect | Printer new line character |
| Local echo | Alternate character set enable |
| Form length | Break action |

NOTES

SET-UPS must be stored in the user permanent memory to be saved. Current column and line numbers are not saved.

When the LA120 is turned on it automatically enters the last settings stored by the operator.

Store

Procedure	Indication/Comments
Enter SET-UP mode	SET-UP light flashes to indicate you are in SET-UP mode.
Press and hold SHIFT and press 	All settings in operating memory are stored in user permanent memory. Numeric display goes blank for a few seconds.
Exit SET-UP mode	SET-UP light stops flashing.

Recall

Procedure	Indication/Comments
Enter SET-UP mode	SET-UP light flashes to indicate you are in SET-UP mode.
Press 	The latest settings stored in user permanent memory are recalled. Numeric display goes blank for a few seconds.
Exit SET-UP mode	SET-UP light stops flashing.

52 OPERATOR INFORMATION

Status

What is the status (contents) of the LA120 temporary memory? A special feature of the LA120 is a printout of all current SET-UP values except tabs and margins.

To read margins and tabs refer to vertical and horizontal margin and tab SET-UP procedures.

The following is a sample printout of the status message using the factory parameters.

Typical Status Message

Parameter	Setting	Parameter	Setting
REC	1200	M	1
XMT	1200	N	1
A	0	O	1
B	1	P	1
C	1	Q	0
D	1	R	1
E	0	S	0
F	66	U	1
G	1	V	6
H	10	W	1
J	1	X	1
K	0	Y	0
L	0	Z	1

The following sample SET-UP label defines the status message.

REC	Receive baud rate		
XMT	Transmit baud rate		
A	Auto-answerback	0=Off	1=On
B	Buffer control	0=Small	1=Large
C	Printer char. set	1=US	2=GB
D	Auto-disconnect	0=Off	1=On
E	Local echo	0=Off	1=On
F	Form length		Lines per form
G	Bell volume	0=low	1=High
H	Horizontal pitch		Char. per inch
J	Auto-newline	0=Off	1=On
K	Key click	0=Off	1=On
L	Auto-linefeed	0=Off	1=On
M	Modem/protocol		
N	Keyboard char. set	1=US	2=GB
O	Alt. char. set	0=Off	1=On
P	Parity/data bits		
Q	HDX initial state	0=XMT	1=REC
R	Auto-repeat	0=Off	1=On
S	Secondary channel	0=No	1=Yes
U	Break enable	0=No	1=Yes
V	Vertical pitch		Lines per inch
W	Printer NL char.	1=None	2=LF 3=CR
X	XON/XOFF	0=No	1=Yes
Y	All keypad mode	0=No	1=Yes
Z	Auto-view	0=Off	1=On
I	Initialize to factory settings		
T	Self test: Type a character to stop		

Procedure

Enter SET-UP mode

Press 

Exit SET-UP mode

Indication/Comments

SET-UP light flashes to indicate you are in SET-UP mode.

Status message prints out.

SET-UP light stops flashing.

NOTE

Do not press **SHIFT** when printing out the status message.

Self-Test Feature

If it appears that a problem exists in the LA120, you can initiate a self-test. Two tests are provided. One prints out characters within the currently selected margins; the other causes the LA120 to go through the same motions as the printing test, but without printing. Use the nonprinting self-test if your printer is loaded with valuable forms such as checks or tickets.

Sample Self-Test Printout

```

.,-./0123456789!;=<=>?@ABCDEFGHIJKLMNPOQRSTUVWXYZ[\
.-./0123456789!;=<=>?@ABCDEFGHIJKLMNPOQRSTUVWXYZ[\]
.,/0123456789!;=<=>?@ABCDEFGHIJKLMNPOQRSTUVWXYZ[\]^
./0123456789!;=<=>?@ABCDEFGHIJKLMNPOQRSTUVWXYZ[\]^_
'0123456789!;=<=>?@ABCDEFGHIJKLMNPOQRSTUVWXYZ[\]^_`
)123456789!;=<=>?@ABCDEFGHIJKLMNPOQRSTUVWXYZ[\]^_`a
.23456789!;=<=>?@ABCDEFGHIJKLMNPOQRSTUVWXYZ[\]^_`ab
?3456789!;=<=>?@ABCDEFGHIJKLMNPOQRSTUVWXYZ[\]^_`abc
{456789!;=<=>?@ABCDEFGHIJKLMNPOQRSTUVWXYZ[\]^_`abcd
|56789!;=<=>?@ABCDEFGHIJKLMNPOQRSTUVWXYZ[\]^_`abcde
}6789!;=<=>?@ABCDEFGHIJKLMNPOQRSTUVWXYZ[\]^_`abcdef
;789!;=<=>?@ABCDEFGHIJKLMNPOQRSTUVWXYZ[\]^_`abcdefs
    
```

Printing Self-Test

Procedure	Indication/Comments
Enter SET-UP mode	SET-UP light flashes to indicate you are in SET-UP mode.
Press  to initiate self-test	LA120 prints out the self-test pattern.
To stop test, exit SET-UP or press any character	Self-test terminates.
Exit SET-UP mode	SET-UP light stops flashing.

Nonprinting Self-Test

Procedure	Indication/Comments
Enter SET-UP mode	SET-UP light flashes to indicate you are in SET-UP mode.
Press and hold SHIFT and press 	LA120 performs a nonprinting self-test.
To stop test exit SET-UP or press any character	Nonprinting self-test terminates.
Exit SET-UP mode	SET-UP light stops flashing.

PART 3 RIBBONS, FORMS, AND IMPRESSIONS

INSTALLING RIBBON

The ribbon used in the LA120 provides approximately six to eight hours of continuous printing. When the print contrast becomes too light the ribbon may be turned over for two more hours of printing and then it should be replaced.

1. Open top cover.
2. Move carriage adjustment lever toward the operator.
3. Remove old ribbon, saving empty spool.
4. Attach the hook located on the end of the ribbon to the empty spool.
5. Wind 10 turns of ribbon onto the empty spool.
6. Place the full spool on the left spool shaft and turn clockwise until it drops into position.
7. Install new ribbon as shown.
8. Adjust impression (described in the following paragraphs).
9. Close cover.

CAUTION

Only *DIGITAL-recommended ribbons (part no. 36-12153-01)* should be used in the LA120. Other ribbons can damage the print head and may void the warranty.

NOTE

If on-line, opening the top cover can cause the telephone line to be disconnected.

PRINT IMPRESSION ADJUSTMENT

1. Open cover.
2. Using carriage adjustment lever, adjust print head for contact with your form.
3. Manually move print head and carriage to the side to check for form smudging or paper rippling.
4. Close cover and type about 10 characters.
5. If smudging or rippling occurs, open cover and move the carriage lever slightly away from the paper (toward operator). Repeat step 3.

NOTE

Ribbon rivet must be on empty spool to ensure correct operation of direction-changing mechanism.

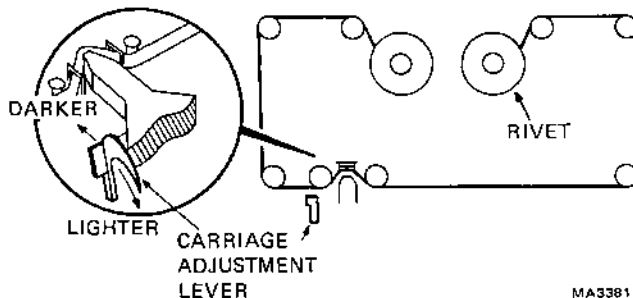

LOADING PAPER/FORMS

The LA120 accepts sprocket-fed, multipart paper/forms ranging in width from 3 to 14-7/8 inches. (Paper specifications are in Chapter 2.)

Initial Paper/Forms Loading

1. Turn the printer off; then open the cover.
2. Loosen the left and right tractor adjusting screws.
3. Position the left tractor feed pins approximately two inches from the left sideplate; then tighten the left tractor adjusting screw. This provides optimum margins for 132-column paper. It may be necessary to readjust when using preprinted forms.
4. Open both tractor covers and move the print head adjustment lever toward you.
5. Place the paper/forms on the floor between the legs of the LA120. Align the leading edge of the paper parallel to the paper slot. Align the left edge of the paper with the left tractor.
6. Feed the paper up through the paper slot. Align the left margin holes over the feed pins. Close the left tractor cover.
7. Align the right margin holes over the feed pins. Tighten the right tractor adjusting screw and close the right tractor cover.
8. Perform the print impression adjustment.
9. Set up your form as described in the forms section of this chapter.

NOTE
If the paper pulls against the tractor pins or bows in the middle, readjust the right tractor.

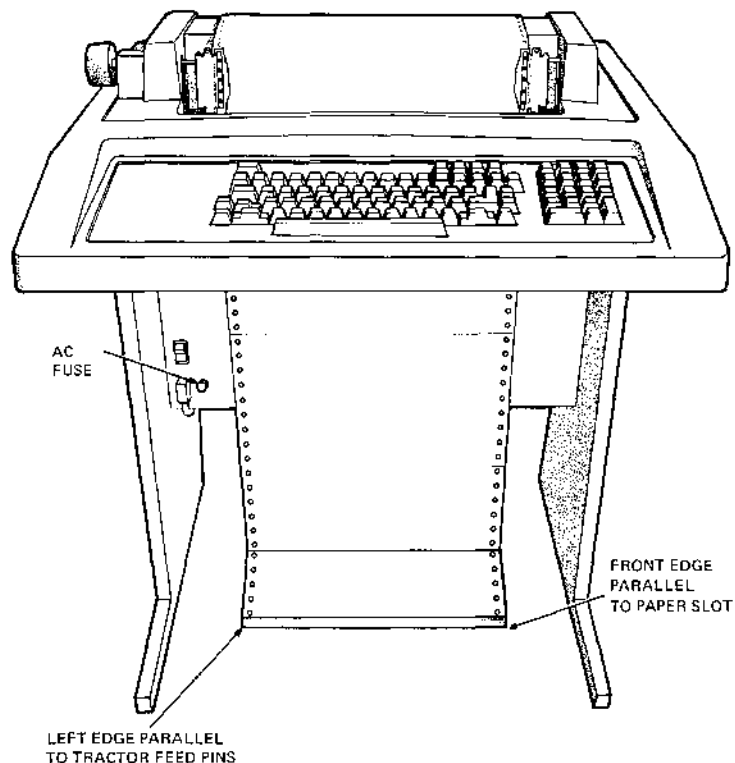

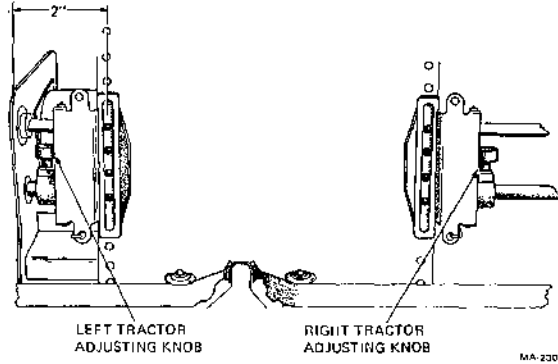

RELOADING PAPER/FORMS

The LA120 operates normally until the end of the form passes the print head. When out of paper, printing stops, the **PAPER OUT** lamp flashes, and the bell sounds for five seconds. The operator should then perform the following procedure.

NOTE

Do not turn power off to load paper. This causes the loss of temporarily stored features.

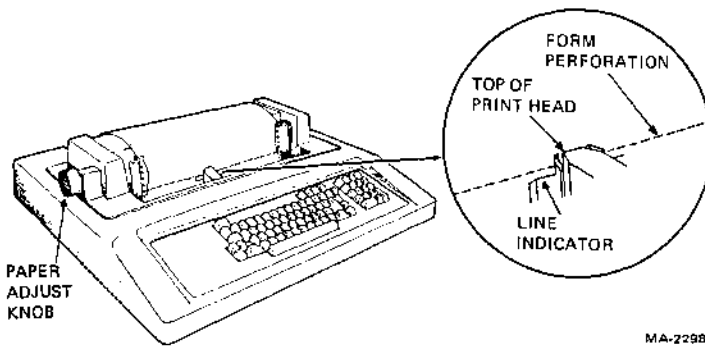

Procedure

1. Open the cover
2. Open the tractors and load the paper

Indication/Comments

NOTE

Perform step 3 before closing the cover.

3. Use the paper advance knob to align the form perforations halfway between the top of the print head and line indicator as shown in the figure.
4. Close the cover.

PAPER OUT light stops flashing. Printing resumes automatically at the correct column and line location.

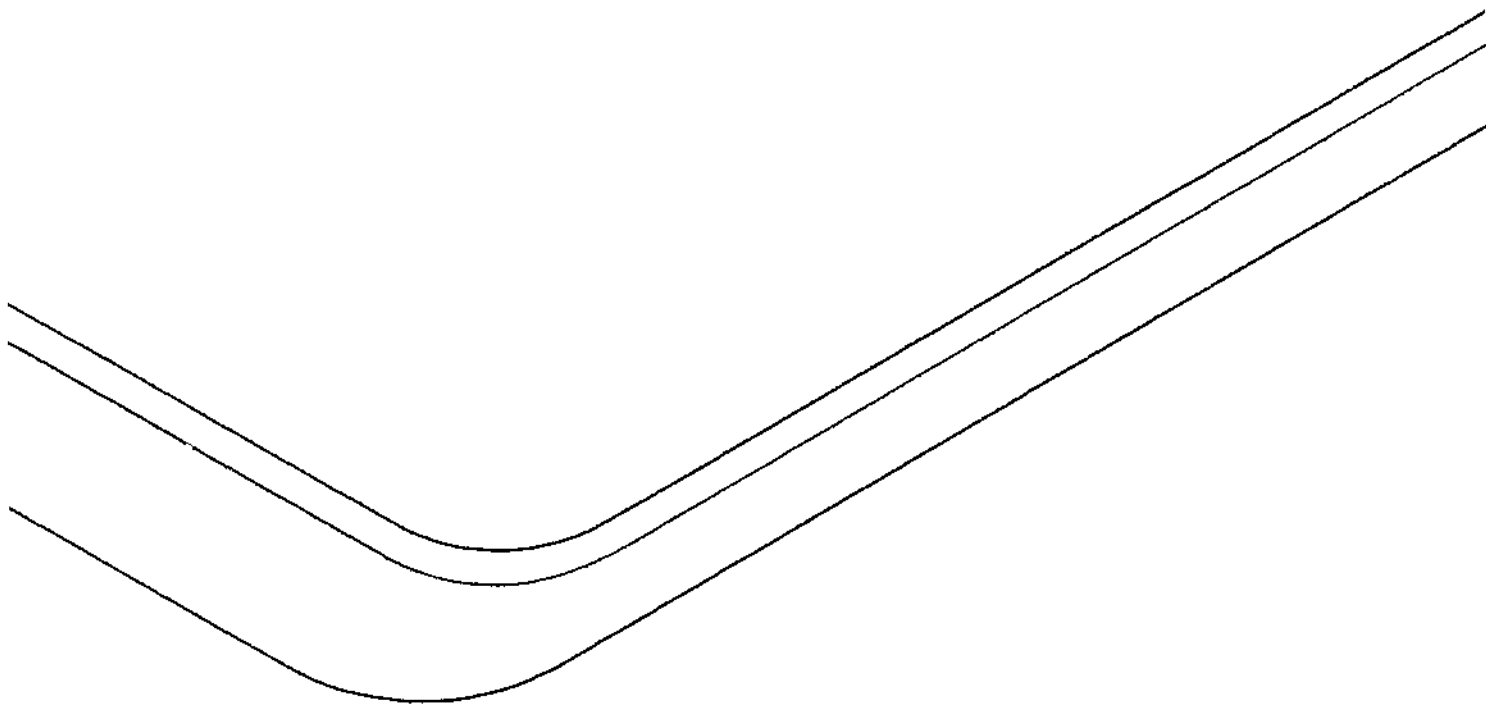

Installation, Interfacing and Specifications

CHAPTER 2 INSTALLATION, INTERFACE, and SPECIFICATIONS

INSTALLATION AND CONFIGURATION

This section contains step-by-step procedures for unpacking, cabling, and unit checkout to ensure that the unit was not damaged during shipment and that the unit is operating properly prior to connection to the communication system.

The LA120 should be installed in an area that is free of excessive dust, dirt, corrosive fumes, and vapors. To ensure that the unit has proper ventilation and cooling, the ventilation openings on the side of the cabinet should not be obstructed.

A minimum 4-inch clearance between units must be maintained at all times. Figure 2-1 illustrates site considerations.

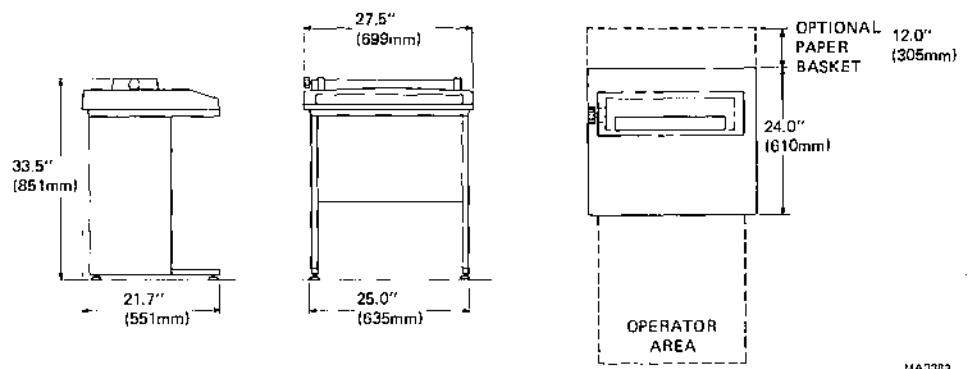
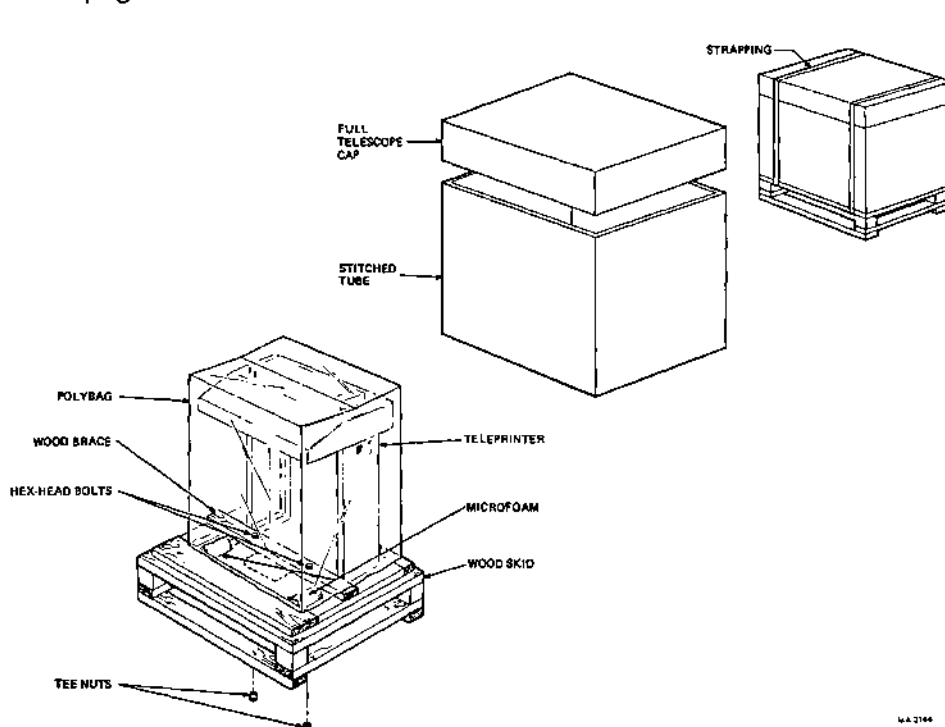

Figure 2-1 LA120 Site Considerations

UNPACKING AND INSPECTION

1. Cut the nylon retaining straps from around the shipping carton and discard them.
2. Remove the outer cardboard shipping container.
3. Remove all shock-absorbing material and packing from around the LA120 (Figure 2-2).
4. Loosen and remove the hex-head bolts that secure the wood leg brace to the skid assembly. Remove the microfoam around each leg of the LA120.
5. Carefully inspect the LA120 cabinet and carriage assembly for possible shipping damage. Inspect and check the enclosed packing list for lost or missing items. Report any damaged or missing items to the local DIGITAL Field Service or Sales Office and the local carrier.
6. Remove the printer from the wooden shipping skid and place it in the desired location.
7. Install and adjust the levelling feet on the LA120 legs.
8. Lift the LA120 top cover assembly. Clip and remove the nylon cable tie securing the print head assembly.
9. If necessary, wipe all outer surfaces with a clean, soft, lint-free cloth.
10. Connect the EIA interface cable to the user's equipment.
11. The LA120 SET-UP label is enclosed in the package with this manual. Fasten the label to the area shown in the figure on the next page.



NOTES

To install the 20 mA option refer to Chapter 5.
 Site plans are not supplied by Digital Equipment Corporation.

Interface logic connections must be specified and provided by the system supplier or the customer because each installation may differ.

Figure 2-2 Unpacking/Packing

REC	Receive baud rate		
XMT	Transmit baud rate		
A	Auto-answerback	0=Off 1=On	
B	Buffer control	0=Small 1=Large	
C	Printer char. set	1=US 2=GB	
D	Auto-disconnect	0=Off 1=On	
E	Local echo	0=Off 1=On	
F	Form length	Lines per form	
G	Bell volume	0=low 1=High	
H	Horizontal pitch	Char. per inch	
J	Auto-newline	0=Off 1=On	
K	Key click	0=Off 1=On	
L	Auto-infeed	0=Off 1=On	
M	Modem/protocol		
N	Keyboard char set	1=US 2=GB	
O	Alt. char set	0=Off 1=On	
P	Parity/data bits		
Q	MDX initial state	0=XMT 1=REC	
R	Auto-repeat	0=Off 1=On	
S	Secondary channel	0=No 1=Yes	
U	Break enable	0=No 1=Yes	
V	Vertical pitch	Lines per inch	
W	Printer NL char.	1=None 2:LF 3=CR	
X	XON/XOFF	0=No 1=Yes	
Y	Alt keypad mode	0=No 1=Yes	
Z	Auto-view	0=Off 1=On	
I	Initialize to factory settings		
T	Self test: Type a character to stop		

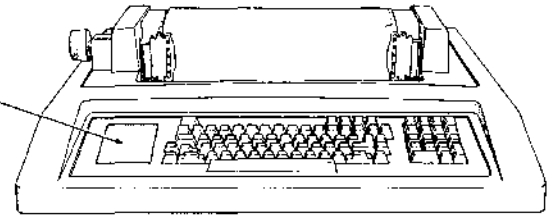

MA-2327

VOLTAGE SELECTOR SWITCH

The LA120 is currently being manufactured with a voltage selector switch. The switch is located above the ON/OFF switch.

Place the tip of a pen into the switch indentation and select the appropriate voltage, as shown in the accompanying figure.

CAUTION
Failure to set the switch to 230 V when plugging the LA120 into a 180–256 V power source will damage the power supply.

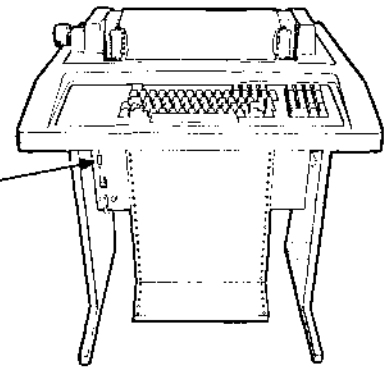
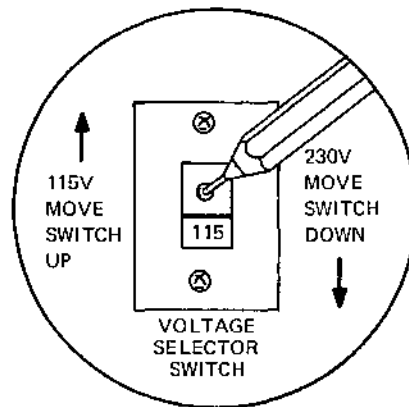

MA-3561

PACKING PROCEDURES

If it becomes necessary to ship your LA120 to another location, repack it per the following procedure.

1. Remove the ribbon and paper.
2. Use a nylon cable tie to secure the print head assembly. This prevents movement during transit.
3. Pack the LA120 as shown in Figure 2-2.

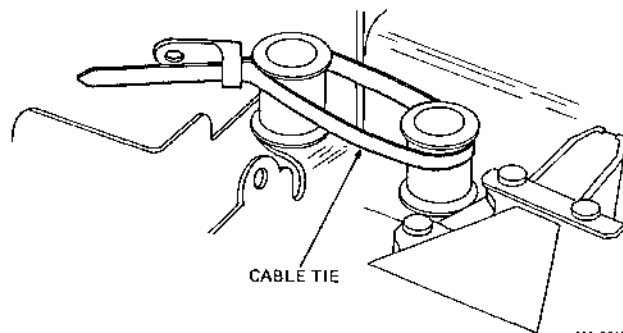

MA-2310

CHECKOUT PROCEDURE

1. Install a ribbon and paper per the procedures in part 3 of the operator's chapter.
2. Connect the LA120 line cord to the correct wall receptacle. Set the power switch to ON. The print head automatically positions itself to the left margin.
3. Perform the self-test procedure in part 2 of the operator's chapter.

CAUTION

Before connecting the LA120 to a power source, ensure that the line voltage and frequency are compatible with the power requirements of the machine. Ensure that the power switch is OFF.

ANSWERBACK JUMPER

To obtain a permanent answerback message that cannot be changed by the operator, remove the jumper shown in the following figure.

NOTES

The answerback message must be stored in permanent memory prior to removing the jumper.

If the jumper is removed the answerback message cannot be altered or erased.

Procedure

1. Store answerback message if required.
2. Verify answerback message.
3. Turn power off.
4. Remove jumper.
5. Turn power on.

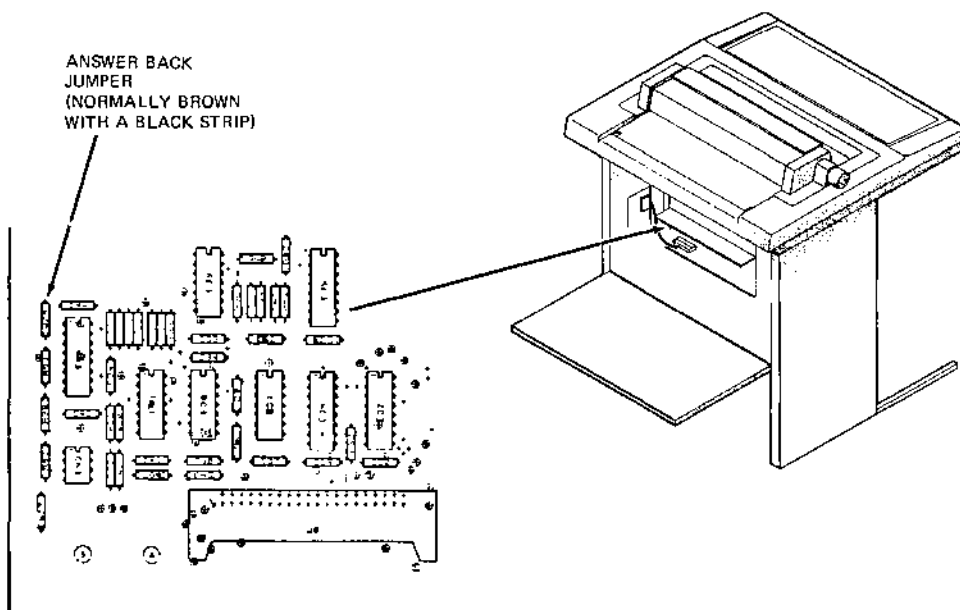

INTERFACE INFORMATION

EIA Interface

The LA120 interfaces with EIA devices using an optional modem cable. The interface is compatible with Bell 103, 212A, and 202 modems and meets the requirements of EIA specification RS232-C. The following paragraphs describe the interface signals.

EIA Cables

- NOTES*
1. For longer lengths use BC03M—(specify length) instead of BC22A.
 2. For longer lengths or full 25 conductors use BC05D—(specify length) instead of BC22B.

BC22A-10 or 25 (see note 1)—10 and 25 foot lengths for hookup between LA120 and computer. Each end is terminated with a female molded connector. Cable is shielded, contains six conductors, and is wired in a null modem configuration.

BC22B-10 or 25 (see note 2)—10 and 25 foot lengths for hookup between LA120 and modem. Can also be used for cable extension.

Connectors are molded with a male connector at one end and a female at the other end. Cable is shielded, and has 14 conductors.

Protective Ground—This conductor is connected to the LA120 chassis. It is further connected to external grounds through the third wire of the power cord.

Transmitted Data (TDX) Direction: from LA120—Signals on this circuit represent serially-encoded characters generated by the LA120.

Received Data (RDX) Direction: to LA120—Signals on this circuit represent serially-encoded characters generated by the user's equipment.

Request to Send (RTS) Direction: from LA120—The on condition of RTS means that the LA120 intends to transmit data. After turning this circuit on, the LA120 waits for a clear to send (transmit enable) condition before starting transmission.

Clear to Send (CTS) Direction: to LA120—Although the LA120 physically receives this signal, it is not used for any purpose. Depending on the modem control protocol in use, either RLSD, SRLSD, or a timeout after asserting RTS is used to provide a clear to send (transmit enable) condition.

Data Set Ready (DSR) Direction: to LA120—The on condition of DSR indicates that the users' equipment is capable of transmitting and receiving data signals. The off condition of DSR causes the LA120 to ignore all other interface inputs except ring indicator (RI). In full duplex without EIA control, this circuit is assumed to always be in the on condition.

Signal Ground—This circuit establishes the common ground reference potential for all interface circuits except protective ground. The circuit is permanently connected to the protective ground circuit.

Carrier Detect (RLSD) Direction: to LA120—The on condition of RLSD indicates that data transmission from the users' equipment to the LA120 is enabled. In full duplex without EIA control, this circuit is assumed to always be in the on condition.

Speed Indicator (SPDI) Direction: to LA120 (full duplex only)—The on condition of SPDI indicates that the baud rate is 1200, regardless of the rate selected by the operator. The off condition indicates that the operator-selected baud rate is being used.

Secondary Carrier Detect (SRLSD) Direction: to LA120 (half duplex only)—The on condition of SRLSD indicates that the users' equipment is capable of successfully processing the transmitted data from the LA120.

Secondary Request to Send (SRTS) Direction: from LA120—In certain half duplex modes the on condition of SRTS indicates that the LA120 is capable of successfully processing the received data from the users' equipment. In restraint mode, the off condition of SRTS indicates that the users' equipment should temporarily suspend the transmission of data. When SRTS goes on, transmission may be resumed.

Data Terminal Ready (DTR) Direction: from LA120—The on condition of DTR indicates that the LA120 is capable of transmitting and receiving data signals. The off condition of DTR may cause the users' equipment to set the data set ready (DSR) to the off condition. The LA 120 ignores all interface inputs except ring indicator (RI) when DTR is off.

Ring Indicator (RI) Direction: to LA120 – If data terminal ready (DTR) is off, the on condition of RI causes DTR to turn on. DTR remains on until data set ready (DSR) turns on or 30 seconds elapses, whichever occurs first. Then DTR turns off. If DTR is on, the on condition of RI causes a 30-second timeout. If no data is received in 30 seconds, DTR is pulsed low for 233 ms – 10 to +10 percent.

Speed Select (SPDS) Direction: from LA120 (full duplex only)—If the operator-selected baud rate is 1200 or higher, the LA120 asserts an on condition on SPDS; otherwise the LA120 holds this circuit in the off condition.

Summary of LA120 EIA Interface Signals

Pin	Source	Name	Function	Circuit CCITT/EIA
1	—	—	Protective ground	101/AA
2	LA120	TXD	Transmitted data	103/BA
3	User	RXD	Received data	104/BB
4	LA120	RTS	Request to send	105/CA
5	User	CTS	Clear to send	106/CB
6	User	DSR	Data set ready	107/CC
7	—	—	Signal ground	102/AB
8	User	RLSD	Carrier detect	109/CF
9	—	—	—	—
10	—	—	—	—
11	LA120	SRTS	Sec. REQ. to send	120/SCA

Pin	Source	Name	Function	Circuit CCITT/EIA
12	User	SPDI	Speed indicator (FDX)	CI
12	User	SRLSD	Sec. carrier det. (HDX)	122/SCF
13	—	—	—	—
14				
15				
16				
17				
18				
19	LA120	SRTS	Sec. req. to send	120/SCA
20	LA120	DTR	Data term ready	108.2/CD
21	—	—	—	—
22	User	RI	Ring indicator	125/CE
23	LA120	SPDS	Speed select (FDX)	CH
24				
25				

NOTE

Pins 11, 19, and 23 are driven by a common circuit whose function is determined by the modem and secondary channel SET-UP commands.

IMPEDANCE OF TERMINATOR

The terminating impedance of the receiving end of the interface circuits has a dc resistance of not less than 3000 ohms nor more than 7000 ohms. When the interface plug is disconnected, the interface voltage on terminator circuits is -2 V to $+2$ V.

RISE AND FALL TIMES

The circuitry that receives signals from an interface circuit is dependent only on the signal voltage and conforms to RS232-C risetime and falltime. For control interface circuits, the time required for the signal to pass through the transition region (-3 V to $+3$ V) during a change in state does not exceed $1 \mu\text{s}$. For the transmitted data circuit the risetime and falltime does not exceed $16.7 \mu\text{s}$ through the 6 V range (-3 V to $+3$ V). The received data and the clock signals also meet this limit.

OPEN CIRCUIT VOLTAGES

The open circuit driver voltage for signal ground on any interface circuit does not exceed -12 V to $+12$ V. The terminator on an interface circuit is designed to withstand any input signal within the -25 V to $+25$ V limit. When the terminating impedance is in the proper range (3000 to 7000 ohms) and the terminator open circuit voltage is zero, the potential at the point of interface is not less than -5 V to $+5$ V or more than -12 V to $+12$ V. An open circuit or applied voltage more negative than $+0.6$ V will be interpreted the same as a legitimate negative applied voltage (-3 V to -25 V).

LA120 SPECIFICATIONS**Printer**

Printing technique	Impact dot matrix, smart bidirectional	
Print matrix (width by height)	7 by 7	
Maximum print speed	180 CPS	
Horizontal slew speed	60 IPS	
Single linefeed time	33 ms	
Vertical slew speed	7.5 IPS	
Paper feed	Pin-feed, tractor drive	
Paper type	Fanfold, up to six parts (see paper requirements)	
Forms length	1 to 168 lines	
Vertical pitch (lines per inch)	2,3,4,6,8,12	
Horizontal pitch (characters per inch)		
180 CPS	10,12,13.2,16.5	
90 CPS	5,6,6.6,8,25	
Maximum line length (varies with horizontal pitch)		
5 CPI	66 columns	
6 CPI	79 columns	
6.6 CPI	87 columns	
8 CPI	108 columns	
10 CPI	132 columns	
12 CPI	158 columns	
13.2 CPI	174 columns	
16.5 CPI	217 columns	
Margins	Left, right, top, bottom	
Tabs	217 horizontal, 168 vertical, from keyboard or line	
Forms storage	True nonvolatile memory (no batteries)	
Positioning commands	Horizontal and vertical, absolute and relative	
Character set	ASCII upper/lowercase set	
National character sets		
Standard	{ United States United Kingdom	
Optional	{ Finland Denmark Sweden Germany Norway France	

APL character set	Optional
Other printer features	Paper out and cover open interlocks, manual and automatic last character view, selectable auto new line, self-test, status message, 4-digit numeric display used as column counter and to set parameters, factory stored form setup (10 CPI, 6 LPI, 66 lines per form tab stops every eight columns, etc.)

Keyboard Specifications

Keyboard	Typewriter style with multi-key rollover
Selectable auto LF	Standard
Optional numeric keypad	18 keys including 4 function keys
Feature selection	Keyboard entry to nonvolatile memory
Other keyboard features	Local form feed key, local line feed key, auto repeat on all alphanumeric keys, and selectable keyclick

Communication Specifications

Data transfer	Serial, asynchronous
Baud rates (BPS)	50,75,110,134,134.5,150,300,600, 1200,1800,2400,4800,7200,9600.
Split speeds (BPS)	600 or 1200 receive, with 75 or 150 transmit; 2400 or 4800 receive, with 300 or 600 transmit.
Parity	Odd, even, or none (8th bit mark or space transmitted, or data bits only)
Input buffer	1024 characters standard, 4096 characters optional
Interface	Full EIA standard (includes auto answer/disconnect)

Physical Specifications

Dimensions	
Width	69.9 cm (27.5 in)
Height	85.1 cm (33.5 in)
Depth	61.0 cm (24.0 in)
Weight	
Uncrated	46.4 kg (102 lb)
Shipping	63.7 kg (140 lb)

Physical Specifications (Cont)**Power**

Transformer power supply

Voltage	87 to 128 V
Frequency	60 Hz + 1 Hz

Switcher power supply

Voltage	90–128 V or 180–256 V
Frequency	47–63 Mhz

Input current 4.2 A max. at 115 V

Heat dissipation – printing 440 W max.

Temperature

Operating	10° to 40°C (50° to 104°F)
Nonoperating	–40° to 66°C (–40° to 151°F)

Relative Humidity

Operating	10 to 90 percent with a maximum wet bulb temperature of 28°C (82°F) and a minimum dewpoint of 2°C (36°F), noncondensing
Nonoperating	5 to 95 percent, noncondensing

Paper Requirements

General	Continuous, fanfold, pin-feed forms
Width	7.6 to 37.8 cm (3 to 14-7/8 in)
Hole spacing	12.7 mm \pm 0.25 mm (0.500 in \pm 0.010 in) non-accumulative over 5 cm (2in)
Hole diameter	3.81 to 4.06 mm (0.150 to 0.160 in)
Forms thickness	
Single part	15 lb paper minimum, 0.25 mm (0.010 in) card stock maximum
Multipart	Up to 6 parts (see notes), 0.50 mm (0.020 in) maximum

NOTES

- Multipart forms may have only one card part. The card part must be the last part.*
- Multipart carbonless forms up to six parts may be used. Ribbon must be used on the top copy. First-surface impact paper is not recommended.*
- Multipart forms with 3- or 4-prong margin crimps on both margins are recommended. Stapled forms are not recommended and may damage tractors and other areas of the machine. Dot or line glue margins are acceptable if line is on one margin only. Line glue on both margins prevents air from escaping and results in poor impressions.*
- Split forms with each side containing a different thickness or number of sheets are not recommended.*

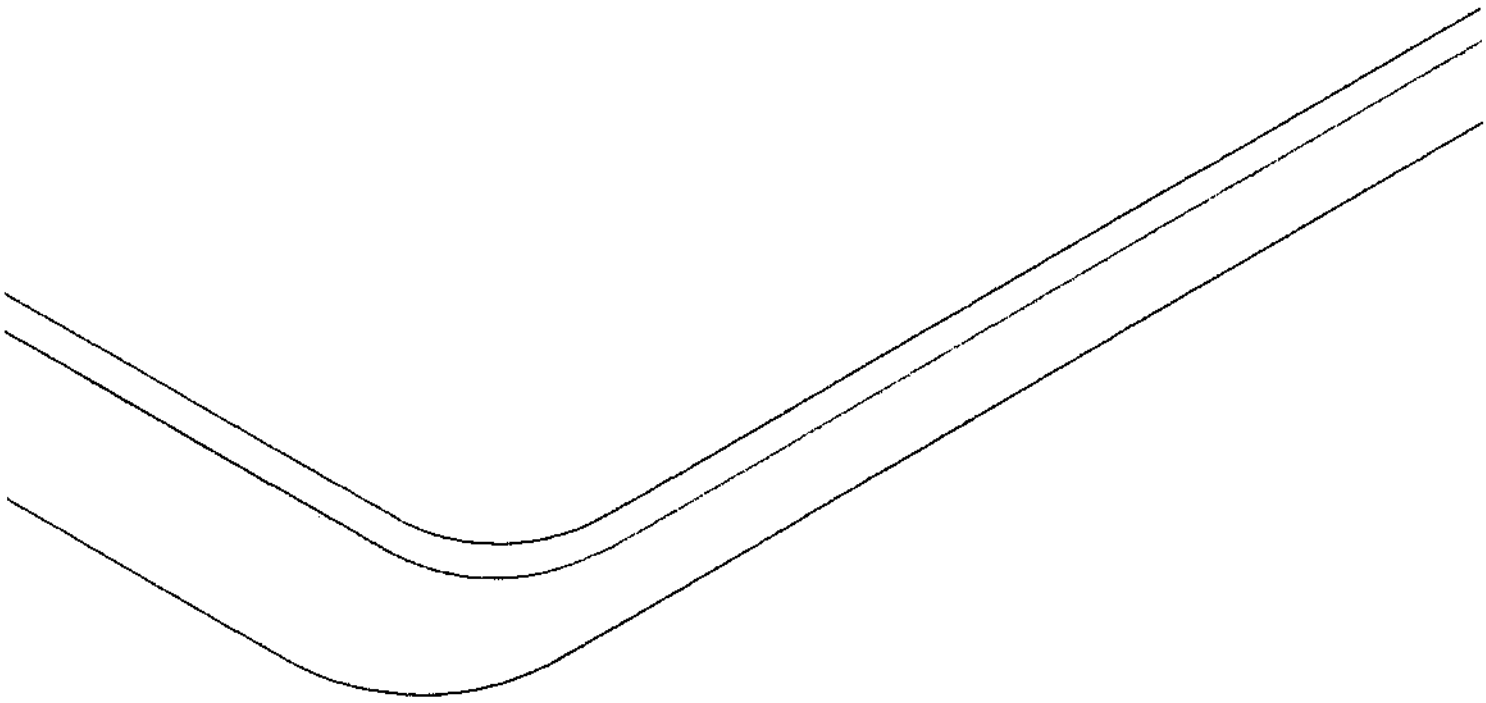

Programmers Section

CHAPTER 3

PROGRAMMER INFORMATION

GENERAL

The LA120 uses escape sequences standardized by ANSI (American National Standards Institute) to control many of its features. For LA120 features lacking an ANSI standard escape sequence, additional escape sequences are defined within the extensions permitted by the ANSI system.

ANSI has established a flexible and comprehensive system for transmitting format and editing information. It can be used with printing terminals like the LA120 and with video terminals and printers and has the following important advantages:

- It is well defined and well documented. This greatly decreases the chance of incompatible implementation and aids in achieving device independence in output.
- It has ample provision for future extension without sacrificing compatibility with older programs. The syntax used in ANSI controls allows a large number of new controls to be added easily.
- It is compatible with all frequently used communication protocols. In contrast, many other systems use control codes that are reserved for communication functions. In these other systems, codes used for line turnaround, disconnect, and synchronization get confused with those used to send parameter values.

Using the escape sequences described in this chapter, the programmer can control the following LA120 features:

- | | |
|-------------------------|---------------------------|
| • Printer character set | • Form length |
| • Active position | • Vertical margins |
| • Horizontal pitch | • Vertical tabs |
| • Horizontal margins | • Product identification |
| • Horizontal tabs | • Line feed new line mode |
| • Vertical pitch | • Alternate keypad mode |

ESCAPE SEQUENCES

The LA120 interprets escape sequences sent to it. None of the characters in an escape sequence are printed. When the end of the sequence is found (or an error occurs), the LA120 reverts to its normal printing mode. Control characters (characters with octal codes 000 through 037) may be embedded anywhere in an escape sequence. The control character performs its normal function and has no effect on the escape sequence. If an escape sequence is received by the LA120 that it does not support, it is ignored.

An escape sequence that has been only partially processed when the operator enters SET-UP mode will complete when he leaves SET-UP mode. Escape sequences may also be entered and processed while in local mode and may be used in lieu of SET-UP commands.

In the lists of escape sequences which follow, the escape character (octal code 033) is designated as ESC. Numeric parameters are shown explicitly or designated as n or $n_1, n_2, \text{etc.}$ The graphic characters in escape sequences are shown using the United States ASCII character set. The characters are spaced apart for clarity only. The space character (octal code 040) never appears in an escape sequence. The case of the characters in escape sequences is significant and must be exactly as documented.

A numeric parameter is a sequence of ASCII decimal digits. That is, octal codes 060 through 071. The parameter is interpreted as an unsigned decimal integer, with the most significant digit transmitted first. Leading zeros are allowed but are not necessary. A missing parameter is interpreted as a value of zero. Plus and minus signs are not allowed in parameters.

Printer Character Sets

The LA120 is capable of receiving and printing both the United States ASCII character set and the United Kingdom version in which the character “#” is replaced by the character “£”.

NOTE

The space character (octal code 040) never appears in an escape sequence.

The following escape sequences select the printer character sets.

Escape Sequence	Function/Comments
ESC (A	Select character set of United Kingdom.
ESC (B	Select character set of United States.

The United States ASCII character set is shown below:

CODE	CHAR	CODE	CHAR	CODE	CHAR
040	space	100	@	140	`
041	!	101	A	141	a
042	"	102	B	142	b
043	_#	103	C	143	c
044	\$	104	D	144	d
045	%	105	E	145	e
046	_&	106	F	146	f
047	'	107	G	147	g
050	(110	H	150	h
051)	111	I	151	i
052	*	112	J	152	j
053	+	113	K	153	k
054	,	114	L	154	l
055	-	115	M	155	m
056	.	116	N	156	n
057	/	117	O	157	o
060	0	120	P	160	p
061	1	121	Q	161	q
062	2	122	R	162	r
063	3	123	S	163	s
064	4	124	T	164	t
065	5	125	U	165	u
066	6	126	V	166	v
067	7	127	W	167	w
070	8	130	X	170	x
071	9	131	Y	171	y
072	:	132	Z	172	z
073	;	133	_ [173	_ [
074	<	134	_ \	174	_ \
075	=	135	_]	175	_]
076	>	136	_ ^	176	_ ^
077	?	137	_		

Optional Character Sets

Five additional national character sets and an APL character set are available as an option. The national character sets are selected by the operator, using setup commands, or by the programmer using escape sequences. The national character sets differ from United States ASCII in only a limited number of code positions.

The code differences among the national character sets are shown below:

Character Set	Code										
	043	100	133	134	135	136	140	173	174	175	176
United States	#	@	[\]	^	`	{		}	~
United Kingdom	£	@	[\]	^	`	{		}	~
Finland	#	@	Å	Ö	Ä	Ü	é	ä	ö	ä	ü
Sweden	#	é	Å	Ö	Ä	Ü	é	ä	ö	ä	ü
Norway/Denmark	#	Å	Æ	Ø	Ä	Ü	ä	æ	ø	ä	ü
Germany	#	§	Å	Ö	Ü	~	`	ä	ö	ü	ß
France	£	à	°	ç	§	~	`	é	ù	è	..

The following additional escape sequences select the optional printer character sets.

- ESC (C Finland
- ESC (E Norway/Denmark
- ESC (H Sweden
- ESC (K Germany
- ESC (R France

NOTE

The space character (octal code 040) never appears in an escape sequence.

Active Column and Active Line

Active column is defined as the column where the next character will normally be printed. Active line is defined as the line where the next character will normally be printed. Column and line numbers begin with one, not zero. Printable characters normally increment active column. Linefeeds normally increment active line. Active column and active line are collectively known as active position.

Active position is only loosely linked to the physical position of LA120 print head and paper mechanism. In general, the active column is only recorded when a character is actually printed. Any previous history of active column values is not significant. The active line is different because it may only be advanced, since backward paper motion is not allowed. When the LA120 is idle, the active and physical positions are identical.

In the LA120, bell characters have only an active line attribute. They are not guaranteed to be sounded at any particular column within a line.

In addition to the normal position control characters (space, backspace, carriage return, linefeed, horizontal tab, vertical tab, and form feed) the following escape sequences modify active position.

Escape Sequence	Function/Comments
ESC [n'	Set active column to column n (character after n is octal code 140).
ESC [n a	Advance column by n columns.
ESC E	Set active column to left margin and increment active line.
ESC D	Increment active line (active column unchanged).
ESC [n d	Set active line to line n.
ESC [n e	Advance active line by n lines.

NOTE
n represents a numeric parameter.

Linefeed Newline Mode

Linefeed newline mode is controllable both by the operator and the programmer. If linefeed newline mode is enabled, the characters linefeed, vertical tab, and form feed each return the active column to the left margin in addition to their normal functions. Linefeed newline mode may be enabled by the operator selecting choice 2 (linefeed) in the printer newline character SET-UP command. The mode is disabled any time the operator selects choice 1 (none) or choice 3 (carriage return) in the printer newline character SET-UP command.

The following escape sequences control linefeed newline mode.

Escape Sequence	Function/Comments
ESC [20 h	Enable linefeed newline mode.
ESC [20 l	Disable linefeed newline mode.

Horizontal Pitch

Horizontal pitch determines the width of printed characters as well as their spacing. The LA120 has eight different horizontal pitches. Any combination of pitches may be used on a single print line. Changing horizontal pitch modifies the active column. The resulting new active column is that of the first column boundary at or to the right of the physical position of the previous active column in the old pitch. It is calculated as:

$$\text{Newcol} = 1 + \frac{(\text{Oldcol} - 1) \text{Oldpitch}}{\text{Newpitch}}$$

where: Newcol = new active column
Newpitch = new pitch in chars/inch
Oldcol = old active column
Oldpitch = old pitch in chars/inch

The division performed above is integer division. Any remainder or fractional part of the quotient is discarded.

The following escape sequences set horizontal pitch.

Escape Sequence	Function/Comments
ESC [w or ESC ow	10 char/inch
ESC [1 w	10 char/inch
ESC [2 w	12 char/inch
ESC [3 w	13.2 char/inch
ESC [4 w	16.5 char/inch
ESC [5 w	5 char/inch
ESC [6 w	6 char/inch
ESC [7 w	6.6 char/inch
ESC [8 w	8.25 char/inch

Horizontal Margins

Printing is permitted only within the inclusive left and right margins. A carriage return character sets the active column to the left margin. Attempting to move the active column left of the left margin sets the active column equal to the left margin. Attempting to move the active column more than one column right of the right margin executes an auto-newline if auto-newline is enabled. If auto-newline is disabled, an error bell sounds and the character or command which attempted the motion is discarded.

Horizontal margins may be set so long as $1 \leq \text{left margin} \leq \text{right margin} \leq \text{max column}$. Note that max column (13.2 inches * horiz pitch) is a function of horizontal pitch, where the product is rounded down to the nearest column. The following escape sequences set the left and right margins.

Escape Sequence	Function/Comments
ESC [n s or ESC [n;0s	Set left margin to column n
ESC [;n s or ESC [0; ns	Set right margin to column n
ESC [n ₁ ; n ₂ s	Set left margin to column n ₁ and set right margin to column n ₂ .

Horizontal Tabs

The LA120 has 217 possible horizontal tab stops, one for each column. Tab stops are associated with column numbers, not physical positions on the paper. Thus, changing horizontal pitch will also change the physical position of tab stops. Each stop may be set or cleared independently. Setting a stop already set has no effect; the same is true for clearing a stop already clear. Tab stops may be set or cleared without regard to margins or horizontal pitch.

Escape Sequence	Function/Comments
ESC H	Set horizontal tab stop at active column.
ESC 1	Set horizontal tab stop at active column (see note 2).
ESC g or ESC 0g	Clear horizontal tab stop at active column.
ESC 2 g	Clear all horizontal tab stops.
ESC 3 g	Clear all horizontal tab stops.
ESC 2	Clear all horizontal tab stops (see note 2).
ESC n u	Set horizontal tab stop at column n.
ESC n ₁ , n ₂ u	Set horizontal tab stops at column n ₁ and at column n ₂ .
ESC n ₁ ; n ₂ ; ..n _x u	Set horizontal tab stops at columns n ₁ ; n ₂ ; . . . n _x (x ≤ 16).

NOTES

1. n represents a numeric parameter.
2. These escape sequences are available for compatibility with the LA36.

Vertical Pitch

Vertical pitch determines the spacing between lines, not the height of printed characters. Changing vertical pitch does not affect active line number; but it does clear vertical margins.

The following escape sequences set vertical pitch.

Escape Sequence	Function/Comments
ESC z or ESC 0z	6 lines per inch
ESC 1 z	6 lines per inch
ESC 2 z	8 lines per inch
ESC 3 z	12 lines per inch
ESC 4 z	2 lines per inch
ESC 5 z	3 lines per inch
ESC 6 z	4 lines per inch

Form Length

Form length is defined in lines, not physical units. Therefore, changing vertical pitch will alter the physical form length. Forms may be from 1 to 168 lines in length. Changing form length clears vertical margins and defines the current line as line one. The following escape sequence sets form length.

Escape Sequence	Function/Comments
ESC [n t	Set form length to n lines, set top margin to line 1, set bottom margin to line n, set active line to line 1.

Vertical Margins

Printing is permitted only on lines within the inclusive top and bottom margins. When vertical pitch or form length are changed, these margins are cleared; that is, the top margin is set to line one and the bottom margin is set to the form length. The following must be true to successfully set new vertical margins: $1 \leq \text{top margin} \leq \text{bottom margin} \leq \text{form length}$. Whenever active line $<$ top margin or active line $>$ bottom margin, the active line is set to the top margin. For example, a linefeed performed at the bottom margin will execute a form feed.

The following escape sequences set the top and bottom margins.

NOTE
n represents a numeric parameter.

Escape Sequence	Function/Comments
ESC [n r	Set top margin to line n.
ESC [; n r	Set bottom margin to line n.
ESC [n ₁ ; n ₂ r	Set top margin to line n ₁ and set bottom margin to line n ₂ .

Vertical Tabs

The LA120 has 168 vertical tab stops set and cleared similar to horizontal tab stops. Vertical tab stops are associated with specific line numbers, not physical positions on the paper. Thus, changing vertical pitch changes the printing position of vertical tabs.

The following escape sequences set or clear vertical tab stops.

Escape Sequence	Function/Comments
ESC J	Set vertical tab stop at active line.
ESC 3	Set vertical tab stop at active line (see note 2).
ESC 1 g	Clear vertical tab stop at active line.
ESC 4 g	Clear all vertical tab stops.
ESC 4	Clear all vertical tab stops (see note 2).
ESC n v	Set vertical tab stop at line n.
ESC n ₁ ; n ₂ v	Set vertical tab stops at line n ₁ and at line n ₂ .
ESC n ₁ ; n ₂ ; . . . n _x v	Set vertical tab stops at line n ₁ , n ₂ , . . . n _x (x < 16).

PRODUCT IDENTIFICATION

The LA120 terminal automatically transmits an answer to the ANSI standard request for a device attributes escape sequence.

The following escape sequence causes the LA120 to transmit its product identification escape sequence.

Escape Sequence	Function/Comments
ESC c or ESC Oc	LA120 transmits ESC ? 2 c

NOTES

- n* represents a numeric parameter.
- These escape sequences are available for compatibility with the LA36.

Alternate Keypad Mode

Alternate keypad mode allows application programs to differentiate between keystrokes performed on the optional numeric pad and those performed on the main keyboard so that the numeric pad may be used for commands or special functions.

Alternate keypad mode is controllable by the operator using the alternate keypad mode SET-UP command, or by the programmer. If alternate keypad mode is disabled, the keys on the optional numeric keypad transmit the codes that correspond to the keycap legends. If alternate keypad mode is enabled, each of these keys transmits the escape sequence specified below.

The following escape sequences control alternate keypad mode.

Escape Sequence	Function/Comments
ESC =	Enable alternate keypad mode.
ESC >	Disable alternate keypad mode.

80 PROGRAMMER INFORMATION

Code Transmitted

Key	Normally	Alternate Keypad Mode
PF1	ESC O P	ESC O P
PF2	ESC O Q	ESC O Q
PF3	ESC O R	ESC O R
PF4	ESC O S	ESC O S
ENTER	Same as RETURN key	ESC O M
, (comma)	, (comma)	ESC O l
- (dash)	- (dash)	ESC O m
. (period)	. (period)	ESC O n
0 (number)	0 (number)	ESC O p
1	1	ESC O q
2	2	ESC O r
3	3	ESC O s
4	4	ESC O t
5	5	ESC O u
6	6	ESC O v
7	7	ESC O w
8	8	ESC O x
9	9	ESC O y

Control Characters

The LA120 receives the following control characters and responds accordingly.

Code	Mnemonic	Name
000	NUL	Null
003	ETX	End of Text
004	EOT	End of Transmission
005	ENQ	Enquiry
007	BEL	Bell
010	BS	Backspace
011	HT	Horizontal Tabulation
012	LF	Line Feed
013	VT	Vertical Tabulation
014	FF	Form Feed

Code	Mnemonic	Name
015	CR	Carriage Return
016	SO	Shift Out
017	SI	Shift In
020	DLE	Data Link Escape
030	CAN	Cancel
032	SUB	Substitute
033	ESC	Escape
177	DEL	Delete

Control characters not listed above are always ignored when received by the LA120.

Null or Delete (NULL or DEL)

Null and delete characters cause no operation. But they are different from ignored characters in that they are disposed of without occupying space in the input buffer. Thus they are fill characters and truly equivalent to idle marking time.

End of Text (ETX)

If the LA120 is operating in half duplex with ETX turnaround, the end of text character is recognized as the turnaround character. If the LA120 is operating in any other full or half duplex mode, the ETX character has no effect.

End of Transmission (EOT)

If the LA120 is operating in half duplex with EOT turnaround, the end of transmission character is recognized as the turnaround character. If the LA120 is operating in any other full or half duplex mode, the EOT character is recognized as a disconnect request, unless the auto disconnect feature is turned off. For disconnect request in half duplex with EOT turnaround, see Data Link Escape (DLE)>

Enquiry (ENQ)

The LA120 automatically transmits its answerback message upon receipt of ENQ.

Bell (BEL)

The bell character sounds a momentary 2400 Hertz tone. No more than eight bells can be pending at any one time.

Backspace (BS)

The backspace character decrements the active column, unless the active column is at the left margin, in which case the backspace character is ignored.

Horizontal Tab (HT)

The horizontal tab character advances the active column to the next horizontal tab stop greater than the current active column but no greater than the right margin. If there is no such tab stop, the active column is advanced to the column after the right margin.

Line Feed (LF)

The line feed character increments the active line, unless the active line is at the bottom margin, in which case it sets the active line to the top margin of the next page. If linefeed newline mode is enabled, the active column is set to the left margin.

Vertical Tab (VT)

The vertical tab character advances the active line to the next vertical tab stop greater than the current active line but no greater than the bottom margin. If there is no such tab stop, the active line is set to the top margin (on the next page). If linefeed newline mode is enabled, the active column is set to the left margin.

Form Feed (FF)

The form feed character advances the active line to the top margin of the next page, which may or may not be the physical top of form. If linefeed newline mode is enabled, the active column is set to the left margin.

Carriage Return (CR)

The carriage return character returns the active column to the left margin. If carriage return is selected as the printer newline character, the active line is incremented.

Shift In (SI)

The shift in character shifts the printer to the primary character set. If no secondary character set (such as APL) is installed, this character has no effect.

Shift Out (SO)

The shift out character shifts the printer to the secondary character set. If no secondary character set (such as APL) is installed, or if alternate character set is disabled, this character has no effect.

Data Link Escape (DLE)

If the LA120 is operating in half duplex with EOT turnaround, the data link escape character, when received or transmitted immediately prior to an EOT, causes the EOT to be interpreted as a disconnect request. If the LA120 is operating in any other full or half duplex mode, the DLE character has no effect.

Cancel (CAN)

The cancel character terminates any pending escape sequence and causes the sequence to be ignored.

Substitute (SUB)

The substitute character is interpreted as being in place of a character received in error. Characters received with parity errors are converted to the SUB character. If characters are ever lost due to input buffer overflow, a SUB character is placed in the input buffer at that point. The SUB character is printed as the following graphic symbol:

⌘

The SUB character also has the effect of a cancel character.

Escape (ESC)

The escape character is interpreted as introducing an escape sequence. Escape sequences are described in detail in their own section of this chapter.

APL Character Set

If the alternate character set SET-UP feature is enabled, the optional APL character set can be selected by the SO control character, independent of the national character set in use. The SI control character returns the printer to the previously selected national character set.

For the APL keyboard to work properly the keyboard character set must have been set by the operator to United States or United Kingdom.

CODE	CHAR	CODE	CHAR	CODE	CHAR	CODE	CHAR
040	SPACE	070	8	120	*	150	H
041	"	071	9	121	?	151	I
042)	072	(122	P	152	J
043	<	073	[123	Γ	153	K
044	⊥	074	;	124	~	154	L
045	=	075	x	125	↓	155	M
046	>	076	:	126	u	156	N
047]	077	\	127	w	157	O
050	v	100	--	130	∩	160	P
051	^	101	α	131	↑	161	Q
052	≠	102	⊥	132	c	162	R
053	÷	103	n	133	←	163	S
054	,	104	L	134	→	164	T
055	+	105	ε	135	→	165	U
056	.	106	_	136	∩	166	V
057	/	107	∇	137	+	167	W
060	0	110	Δ	140	∅	170	X
061	1	111	ι	141	A	171	Y
062	2	112	◦	142	B	172	Z
063	3	113	'	143	C	173	{
064	4	114	□	144	D	174	
065	5	115	∫	145	E	175	}
066	6	116	τ	146	F	176	\$
067	7	117	∅	147	G		

Sample Form SET-UP Using Escape Sequences

All form control features available to the operator in SET-UP mode can also be transmitted to the LA120 using escape sequences. The form illustrated in Chapter 2, Part 2 could be set up using the following escape sequences.

Escape Sequence	Function/Comments
ESC 1 z	Selects 6 lines per inch.
ESC 6 6 t	Sets form length to 66 lines and sets top-of-form at current line.
ESC 4; 5 8 r	Sets top margin at line 4 and bottom margin at line 58.
ESC 4 g	Clears all vertical tabs.
ESC 8; 2 0; 2 5; 4 5 v	Sets vertical tabs at lines 8, 20, 25, and 45.
ESC 1 w	Sets horizontal pitch to 10 characters per inch.
ESC 3; 8 2 s	Sets left margin to column 3 and right margin to column 82.
ESC 2 g	Clears all horizontal tabs.
ESC 1 0; 2 1; 4 1 u	Sets horizontal tabs at columns 10, 21 and 41.

Synchronization

When the LA120 receives a character (other than the fill characters, NUL and DEL), it stores it in its 1000 character input buffer. When the printer is ready, characters are fetched from the input buffer and printed. If the printer falls behind by more than about 1000 characters, the input buffer overflows and data is lost. There are three ways to avoid buffer overflows.

1. Send data only as fast as it can be printed. When receiving data at 1200 baud or less, the LA120 can keep up with normal character sequences. Very short lines and multiple form feeds cannot be printed this fast. Fill characters may be used to slow the effective data transmission speed in these cases. Fill time formulas are given below.
2. Limit the length of your message to the LA120's input buffer size. If the buffer is empty at the beginning of your transmission, you can send a message of about 1000 characters without worrying about buffer overflow.
3. Use a terminal synchronization protocol, such as XON/XOFF or restraint mode. Using a synchronization protocol, the LA120 can tell the data source when to pause in sending data and when to resume. Synchronization allows maximum throughput and eliminates the need for fill character calculations and message size limits.

When synchronization is used, the LA120 constantly monitors the number of characters stored in its input buffer. When the number of characters exceeds a "high water mark," the LA120 signals the data source to pause temporarily. Meanwhile, the printer continues to take characters out of the input buffer. When the number of characters remaining is less than a "low water mark," the LA120 signals that transmission may resume. The values used for the high and low water marks are selected by the buffer control SET-UP command.

The LA120 also sends a pause signal when the printer is not ready due to error conditions or operator actions. Running out of paper or detecting a print head jam can cause a pause request to be sent. The operator can induce a pause request by opening the cover or entering SET-UP mode.

The pause and resume signals to the data source are sent either or both of two ways:

1. Using the control characters XON (octal code 021) and XOFF (octal code 023)
2. Using the EIA signal SRTS in restraint mode.

Restraint mode operation is suited for local, hard-wired installations, especially when the LA120 is used as a serial line printer replacement. Restraint mode is selected using SET-UP commands: "S:" (secondary channel) must be "1" (enabled) and "M" (modem/protocol) must be "1" (full duplex, no EIA controls).

XON/XOFF is suitable for either local or remote operation, so long as the connection is full duplex. To select XON/XOFF operation the "X" SET-UP must be set to "1" (enabled). The XON/XOFF protocol is complicated by the fact that the synchronization characters may be interspersed between the characters typed at the LA120 keyboard. The operator can tell the data source to pause by typing XOFF (CTRL-S) and to resume by typing XON (CTRL-Q). To make sure that neither the buffer controller's nor the operator's pause requests are lost, typed characters may be transmitted with an XOFF character immediately following.

If XON/XOFF is enabled the LA120 transmits XON when first powered up and transmit enabled.

Synchronization Limits

"B" SET-UP choice	Low limit	High limit
0 (small)	50 chars	60 chars
1 (large)	256 chars	576 chars

Fill Time Formulas

Horizontal Movement

Includes horizontal tabs and horizontal positioning escape sequences. First convert to actual number of columns moved, then allow 15 ms for each of the first ten columns (30 ms in double-width pitches) and 5.5 ms for each additional column (11 ms in double-width pitches).

Vertical Movement

Includes line feeds, vertical tabs, form feeds, and vertical positioning escape sequences. First convert to actual number of lines moved, then allow 33 ms for the first line moved up to 1/6 inch and 135 ms for each additional inch.

Keyboard Operation

The LA120 operator's console contains a typewriter-style keyboard resembling an office typewriter in key size, shape, and location. The keyboard also contains a 4-digit numeric display and 8 binary indicators. There is provision for an optional, field installable numeric keypad.

The operator uses the keyboard to transmit codes. If the LA120 is transmit-enabled, codes are transmitted as each key is pressed except during auto repeat activity or with certain combinations of three or more keys held down which cannot occur in normal touch typing. If the LA120 is not transmit-enabled keystrokes are stored in a 16-character buffer for future transmission. If more than 12 keystrokes are in the buffer, each keystroke generates a 400 Hertz tone to indicate that the buffer is full or nearly full. The buffer will be cleared without transmission any time SET-UP mode is entered or exited, line/local status is toggled, or a break is transmitted.

Auto Repeat

If auto repeat is enabled and a key that generates the space, backspace, or delete code or any printable character code is held down for more than 0.6 second, the code for that key is transmitted repeatedly at 7.5 characters per second, gradually increasing to 25 characters per second, or at a rate determined by the baud rate, whichever is slower. If auto repeat is in process, all keystrokes are ignored until the repeating key is released. If more than one key is held down prior to the start of auto repeat, only the last key pressed is subject to auto repeat.

Printable Character Keys

There are 47 keys that generate printable character codes. The relationship between these keys and the **SHIFT** and **CAPS LOCK** keys is such that each of the 26 alphabetic keys transmits the lowercase code unless either or both of the **SHIFT** keys are down, or the **CAPS LOCK** key is down. Each nonalphabetic key generates two different codes. One code is generated if neither **SHIFT** key is down. The other code is generated if either or both of the **SHIFT** keys are down. Unlike the **SHIFT LOCK** key of a typewriter, the **CAPS LOCK** key does not affect the nonalphabetic keys. The codes for each code generating key are shown below.

Octal Codes Generated by Keyboard
(Shifted Codes Shown Above Legends;
Unshifted Codes Shown Below Legends)

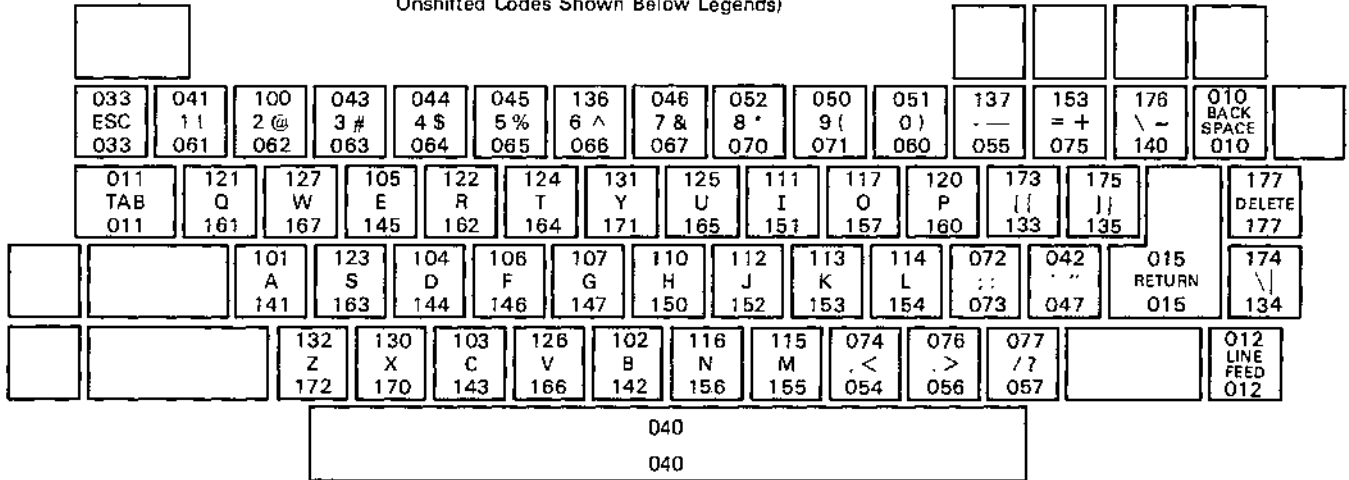

MA33B6

Control Character Keys

There are seven keys that generate control character codes. The codes generated by these keys are independent of the **SHIFT** and **CAPS LOCK** keys.

Key	Octal Code	Function
RETURN	015 or 015 012	CR or NL
LINE FEED	012	LF or NL
BACK SPACE	010	BS
TAB	011	HT
SPACEBAR	040	SP
DELETE	177	DEL
ESC	033	ESC

In coded control half duplex, the **RETURN** key transmits the turnaround character automatically after transmitting its normal code or codes.

CTRL (Control) Key

The **CTRL** key is used in conjunction with certain other keys on the keyboard to generate control character codes. The **CTRL** key is also used in conjunction with the **SET-UP** key to enter **SET-UP** mode.

The codes generated and keys affected by the **CTRL** key are independent of the **SHIFT** and **CAPS LOCK** keys. It is never necessary to hold both the key and the **SHIFT** key down in combination with another key to generate control character codes. Also, there is only one **CTRL** key combination for each of the 32 control characters. Because of these

88 PROGRAMMER INFORMATION

requirements, there are three control characters whose locations on the LA120 may differ from other terminals. These characters and their location on the LA120 and other terminals are shown below.

Code	LA120	Other Terminals
NUL (000)	- SPACE BAR	- -
RS (036)	-	- -
US (037)	-	- -

The characters and codes generated by each key when the CTRL key is held down are shown below.

Characters Generated by Keyboard
with CTRL Key Held Down
(Mnemonics Shown Above Legends;
Octal Codes Shown Below Legends)

ESC ESC 033	1 !	2 @	3 #	4 \$	5 %	6 ^	7 &	8 *	9 (0)	- _	= +	RS ~ 036	BS BACK SPACE 010			
HT TAB 011	XON Q 021	ETB W 027	ENQ E 005	DC2 R 022	DC4 T 024	EM Y 031	NAK U 025	HT I 011	SI O 017	DLE P 020	ESC [[033	GS]] 035		DEL DELETE 177			
		SOH A 001	XOFF S 023	EOT D 004	ACK F 006	BEL G 007	BS H 010	LF/NL J 012	VT K 013	FF L 014	::	::	CR RETURN 015	FS \ 034			
		SUB Z 032	CAN X 030	ETX C 003	SYN V 026	STX B 002	SO N 016	CR M 015	<	>	US /? 037		LF LINE FEED 012				
NUL 000																	

Optional Auxiliary Keypad

The optional auxiliary keypad contains 18 keys that transmit the codes for the characters or escape sequences specified in the escape sequences section of this chapter.

BREAK Key

Pressing the **BREAK** key causes the LA120 to transmit a short break signal to 233 ms duration.

Holding one or both shift keys down and pressing the **BREAK** key causes the LA120 to transmit a long break disconnect signal of 3.5 seconds duration.

The interface leads involved in transmitting break signals are described in Chapter 4.

VIEW Key

If automatic view is in use and the printer has been idle, but has not yet timed out the automatic view delay time, pressing the **VIEW** key causes the view operations to be performed.

If automatic view is not in use, pressing and holding the **VIEW** key causes the print head to idle at the viewing position. With the **VIEW** key released, the print head idles at the ready to print position.

When there is no character to print, the carriage moves to the print cell immediately to the left of the cell designated by the active position (ready to print position). If the printer remains idle longer than the automatic view delay time, the carriage moves to the right to facilitate viewing of the last character printed (viewing position).

The automatic view delay time is a function of keyboard activity. If characters are being typed at a touch typing rate or faster, the time is set long enough to prevent erratic carriage motion. Otherwise it is set to provide instant visibility of single typed or received characters. The automatic view operation may be disabled by the operator using a **SET-UP** command (**SET-UP Z**).

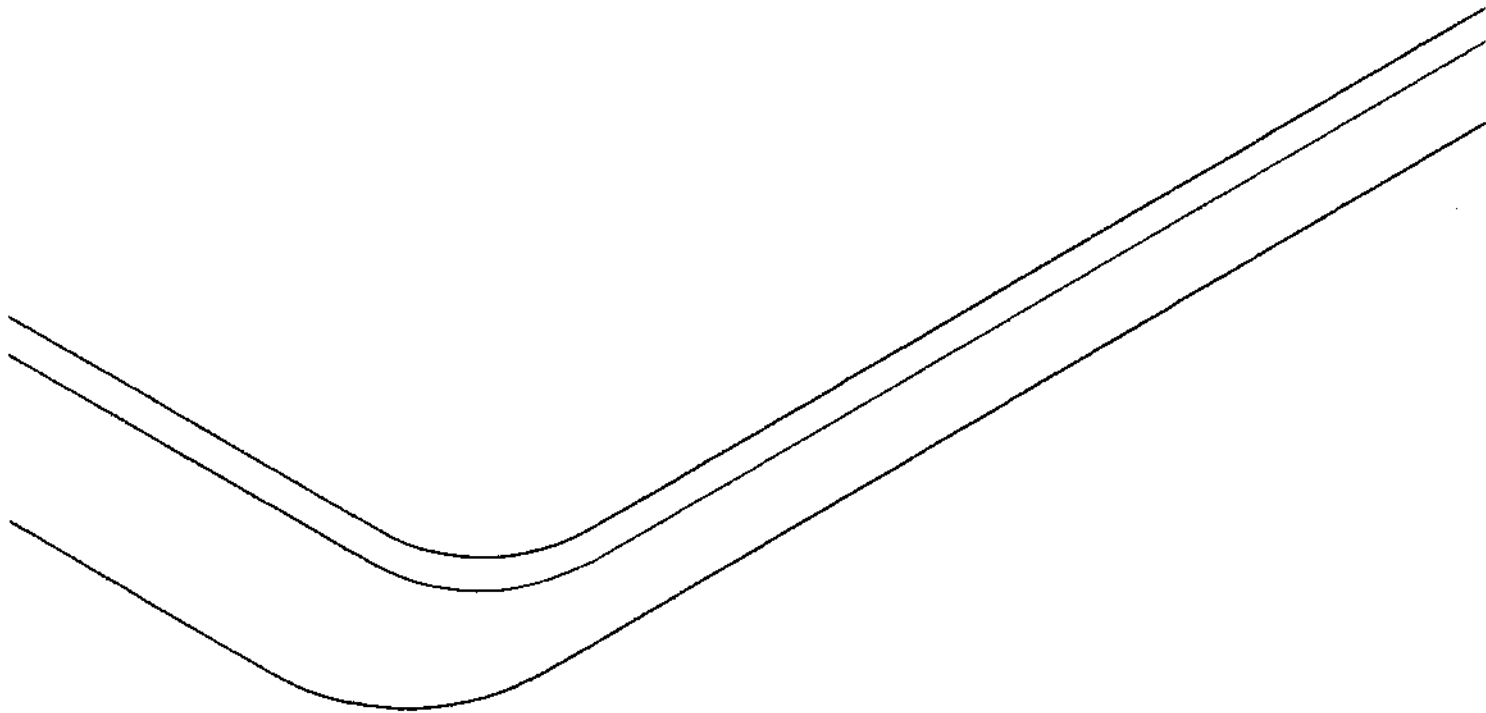

Communication

CHAPTER 4

COMMUNICATIONS

FULL DUPLEX (FDX)

There are two modes of full duplex operation: with EIA control and without EIA control. While on-line, both modes allow simultaneous transmit and receive with the LA120 generating signals DTR and RTS. Full duplex with EIA control subjects the line to connection requirements and disconnect conditions. In full duplex without EIA control, transmission and receive are always enabled if on-line.

Full Duplex Connection Requirements

In full duplex with EIA control, the following conditions must be satisfied before the LA120 allows transmission and reception of data to occur:

1. DSR must be asserted; then the LA120 asserts RTS.
2. RLSD must be asserted for at least 300 ms after DSR is asserted; then the LA120 enables transmission and reception.

Full Duplex Break

In full duplex, a break consists of a 233 ms space on the transmit data line if transmission is enabled. If transmission is disabled, the break remains pending until transmission is enabled or disconnect is generated.

Full Duplex Disconnect Conditions

Hanging up the phone to disconnect from the line is accomplished by dropping DTR for 70 ms and resetting all control lines to their initial state. Three line conditions cause a disconnect:

1. Connection is not established within 20 seconds of a ring indication. (Connection is defined as the assertion of DSR and RLSD.)
2. When initiating a call, and RLSD is not asserted within 5 seconds.
3. Connection is established, and RI asserts, DSR drops, or RLSD drops for 5 seconds.

A command can also initiate a disconnect. An EOT from the keyboard or line will hang up the phone. When a disconnect is initiated from the keyboard, the EOT is sent to the remote end before the disconnect in order for the remote end to also disconnect. Also, a long break disconnect can be generated from the keyboard. This produces a space on the transmit data line and DTR drops for 3.5 seconds.

Restraint Mode vs Speed Control Mode

With either full duplex mode selected, restraint mode or speed control mode, but not both, may be in use. In restraint mode, the LA120 controls the SRTS line to signal an approaching input buffer overflow. This function is analogous to **XON/XOFF**. This signal represents the status of the input buffer only, not a receive ready state. Both DTR and SRTS must be observed to determine the receive state of the LA120.

In speed control mode, the SPDI and SPDS lines exchange speed information between the LA120 and the modem. The LA120 asserts SPDS if the operator-selected baud rate is 1200 or higher. The LA120 forces an operating baud rate of 1200 baud if SPDI is asserted from the modem. These speed selects are intended for use with modems such as the Bell 212A that are capable of 103 type operation at low speeds but use a different modulation technique at high speeds.

HALF DUPLEX (HDX)

Due to the "one at a time" definition of half duplex, elaborate protocols (compared to full duplex) are needed to define whether the LA120 should transmit or receive data at any given time. Each time the transmitter and receiver exchange functions the line is "turned around." Basically this consists of switching the end of the line that asserts RTS, which reverses the transmit/receive mode of the modem and switches the carrier generation from one end to the other. Also, when echo suppressors are on the line, it is necessary to turn them around in order to attenuate in the opposite direction. The LA120 incorporates three methods of controlling line turnaround. In supervisory control mode the host controls all line turnarounds by manipulating the secondary control lines. Reverse channel is mandatory for this mode. The two other protocols (coded control with reverse channel and coded control without reverse channel) allow the transmitting device to control line turnaround using specific control characters. If reverse channel is used, these lines provide confidence as to the fate of the transmitted data. Without these signals the transmission is "blind."

Initial Direction Determination

When LA120 is initially put on-line, data cannot be transmitted or received. When the LA120 is called, RI asserts before DSR. In auto answer mode most modems answer the call (go off hook) before asserting DSR. However, some modems allow DSR to assert after a couple of rings but before the call is answered. With this sequence the LA120 attempts to establish receive mode. If the LA120 operator is initiating the call, DSR asserts when the modem is placed in data mode. Since DSR is asserted without RI, the LA120 attempts to enter either transmit or receive mode,

depending on the HDX initial state SET-UP command. If the LA120 attempts to enter receive mode and RLSD is not asserted within 5 seconds, the normal timeout disconnect occurs.

Reverse Channel

Reverse channel transmits supervisory or error control signals. These signals flow in the opposite direction from which data is being transferred. Due to the relative lower bandwidth of the reverse channel (to the forward channel), it is not used for data exchange.

Modem Delay

When the host sets RTS, the LA120 sees the change as asserting RLSD. Conversely, when the host drops RTS, the LA120 sees the change as dropping RLSD. However, there is delay between dropping RTS by the host and the loss of RLSD by the LA120. This delay is dependent upon the modem. For example, a 2028 modem validates RLSD for 23 ms (7 ms for fast mode timing option) before setting the RLSD present signal. Also the loss of RLSD is signaled 10 ms after the modem detects the drop. The secondary channel responds like the primary channel but between SRTS and SRLSD.

Request to Send Delay

As noted in the RLSD definition, the analog loopback option turns around certain lines to the LA120:

1. RTS asserted causes RLSD to be true,
2. SRTS asserted causes SRLSD to be true,
3. Receive data mimics transmit data (local copy).

For this reason whenever RLSD or SRLSD is to be used, 300 ms must have elapsed since the local driving force (RTS or SRTS) has been removed. Up until that time the signals do not represent the remote end. Also, RTS should not be lowered until the last character is completely serialized (transmit complete).

Turnaround Characters

The two turnaround characters, EOT and ETX, initiate line turnaround when received or transmitted. Any characters sent after the turnaround character are lost. The LA120 automatically sends the turnaround character each time the RETURN key is typed, after sending the normal code for that key.

Half Duplex Break

Half duplex break operates in three modes:

1. Transmit mode (RTS true)—a space on the transmit data line for 233 ms.
2. Received mode (RTS false)—a space on the SRTS line for 233 ms. When operating with 'coded-no reverse channel' the break is ignored when in receive mode.
3. While switching modes—if neither receive nor transmit is enabled the break is not processed until a definite line direction is established.

Loss of Data Set Ready

When DSR is lost, all control lines are set to their initial state.

Half Duplex Disconnect

Hanging up the phone to disconnect from the line is accomplished by dropping DTR for 70 ms and resetting all control lines to their initial state.

There are five line conditions that will cause a DTR disconnect:

1. Line connection not established within 20 seconds of a ring indication. (Connection is defined by the assertion of DST and RSLD.)
2. When initiating a call with reverse channel and SRLSD is not asserted within 5 seconds.
3. Line turnaround not complete within 5 seconds.
4. In coded control RLSD or SRLSD lost for 5 seconds without the turnaround character. If no reverse channel, only RLSD is monitored.
5. Valid line direction established and RING asserts or DSR drops.

In addition, a command can be used to initiate a disconnect. An EOT or DLE-EOT from the keyboard or line will hang up the phone. If EOT is used as the turnaround character, DLE-EOT must be used as the disconnect command. When a disconnect is initiated from the keyboard, the EOT or DLE/EOT is sent to the remote end before the disconnect in order for the remote end to also disconnect.

A long break disconnect can be generated from the keyboard. This produces a space on the transmit data line and drops DTR for 3.5 seconds.

MODEM SET-UP FEATURE DESCRIPTION**General**

The LA120 modem feature offers five different communication choices. Choices 1 and 2 are full duplex; 3, 4, and 5 are half duplex. For each choice there are several possible combinations of SET-UP features. The following is a description of each modem choice, followed by a table illustrating the modem choices in combination with other applicable SET-UP features.

Modem 1

This full duplex choice is used when there are no meaningful modem signals being sent to the LA120, with the exception of receive data. With this choice the LA120 constantly asserts DTR and RTS. The primary situations for this mode are:

1. Current loop interface on LA120
2. Full duplex modems or acoustic couplers where data set ready or carrier detect are not available.

NOTE

If modem=1, the modem will not recognize paper out, head jam, cover open, or any other disconnect associated with data terminal ready.

Modem 2

This full duplex choice supports a full modem interface. Some of the equipment commonly used in this mode are:

1. Bell 103 modems and acoustic couplers/modems that emulate 103 modems with regard to DSR, carrier, and ring

NOTE
Local Echo (SET-UP E)—Most full duplex systems (hosts) echo the character keyed back to the terminal to print it. However, this is totally a host system configuration parameter, not a function of the full or half duplex communication link. If the system does not echo the characters keyed, local echo should be enabled.

2. Vadic 3400 full duplex modems
3. Bell 212A modems (see Speed Control information in this chapter).

In this mode DTR is always asserted, except during the 70 ms or 3.5 second disconnects (described previously in Full Duplex Hang Up). The terminal is not ready to receive or transmit until a valid terminal/modem link is established using the proper modem signals.

Half Duplex

The following three half duplex modes require a Bell 202C, 202S, or equivalent modem/acoustic coupler. SET-UP M defines the actual protocol to control line turnaround. Proper protocol is totally dependent on the host computer. The following questions should be asked of a knowledgeable host computer representative.

1. Is turnaround controlled by the host (supervisory) or are control codes used to control the line (coded) control? If supervisory is used, set modem=3 and skip questions 2 and 3. If coded control ask:
 2. Which character is used for turnaround?
 If the character is **EOT** set modem=4.
 If the character is **ETX** set modem=5.
 3. Is the secondary channel used?
 Yes - set S=1
 No - set S=0.

Modem 3

This is the first of three half duplex modes, commonly referred to as supervisory mode. The host controls all line turnarounds by controlling the primary and secondary channels. The LA120 responds by switching between receive and transmit states and indicating that state to the host. No turnaround characters are sent or interpreted with this mode. Secondary channel is mandatory for this mode, therefore SET-UP S is ignored.

Modem 4

In this half duplex mode, line direction is controlled by the transmitting device. When an EOT is sent from the transmitter (host or terminal), both ends change state. An EOT is sent after a carriage return code is sent via the **RETURN** key on the L120. This causes a turnaround without the operator entering the control code. A disconnect is generated whenever a DLE/EOT pair is received or transmitted.

Modem 5

The final half duplex mode is basically the same as modem 4, but the ETX character controls line turnaround. This character is transmitted for each line turnaround and is appended to a carriage return code generated via the **RETURN** key. A disconnect is generated whenever an EOT is received or transmitted.

Summary of Modem Features LA120 SET-UP FEATURES

Modem Setup Choices	Auto Answer-back	Buffer Control	XON/XOFF	Auto Disconnect	Local Echo	HDX Initial Calling State	Secondary Channel	Break Action
(FDX no modem, XON/XOFF enabled)	Off	As required	Enabled	Off	As required	No effect	As required	As required
1 (FDX no modem, XON/XOFF disabled)	Off	No effect	Disabled	Off	As required	No effect	As required	As required
2 (FDX modem, XON/XOFF enabled)	As required	As required	Enabled	As required	As required	No effect	As required	As required
2 (FDX modem, XON/XOFF disabled)	As required	No effect	Disabled	As required	As required	No effect	As required	As required
3 (HDX modem)	As required	No effect	Disabled	As required	On	No effect	No effect	As required
4 (HDX modem)	As required	No effect	Disabled	As required	On	As required	As required	As required
5 (HDX modem)	As required	No effect	Disabled	As required	On	As required	As required	As required

EFFECTS OF PAPER OUT

The LA120 operates normally until the physical end of paper passes the print head; then printing ceases. If the data source is using XON and XOFF, no data is lost. If auto disconnect is enabled, the data terminal ready signal becomes unasserted during the paper out and recovery interval. If break is enabled, a break signal is sent when the paper out condition occurs. The possible paper out actions as function of auto disconnect (D), break enable (U), and XON/XOFF enable (X) SET-UP commands are shown below.

	X=1 U=0 or 1	X=0 U=1	X=0 U=0
D=0	XOFF	Break	No action
D=1	XOFF then DTR Low	DTR low	DTR low

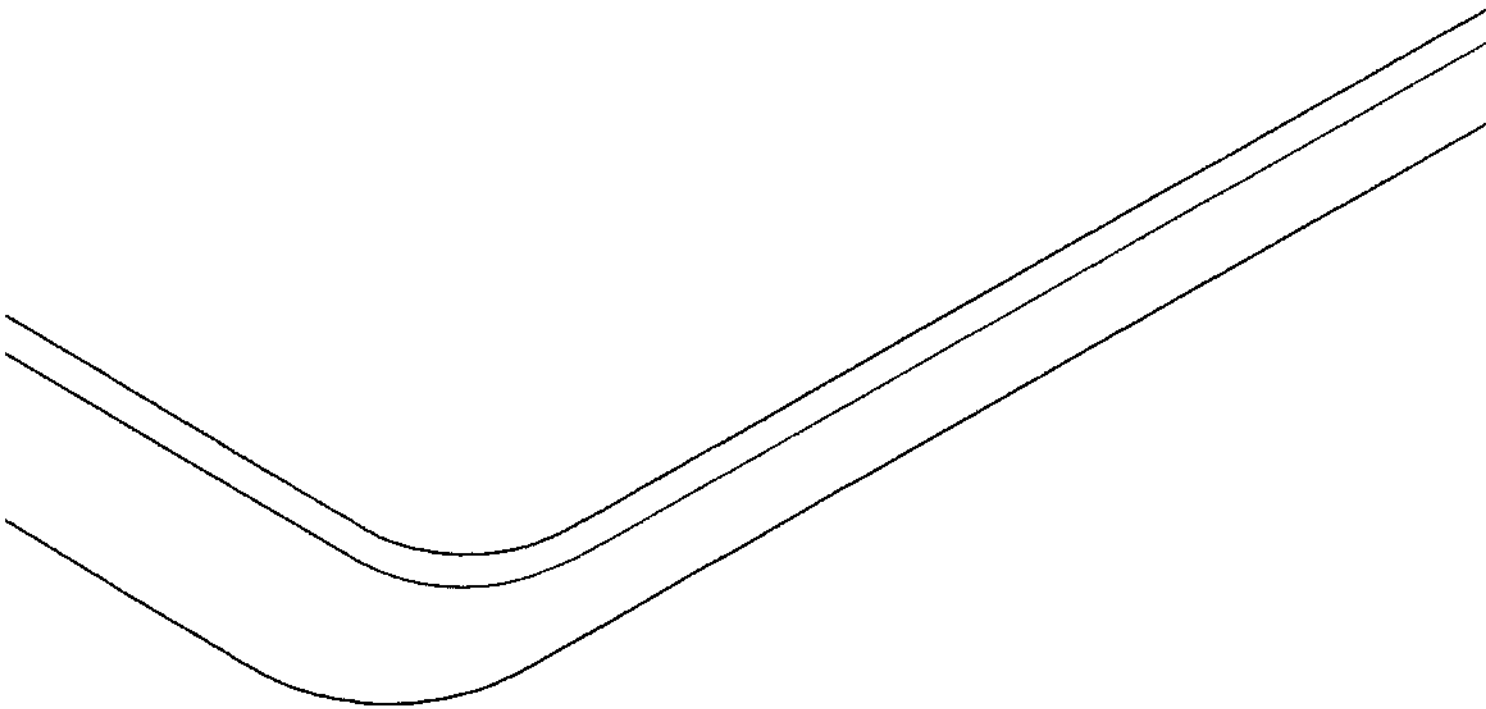

Options

CHAPTER 5

OPTIONS

20 mA LA12X-AL

The 20 mA loop option allows the terminal to communicate directly with the computer up to a distance of 305 m (1000 ft) without the use of a modem.

Installation

The 20 mA LA12X-AL option kit contains the following items.

Item	Qty.	Description	Part No.
1	1	20 mA external interface cable	BC05F
2	1	20 mA assembly (logic board)	AD-7016059-0-0
3	1	20 mA harness assembly	AD-7016186-0-0
4	2	Screw, hex-head slotted #8-32, 0.38 long	9009988-08
5	2	Washer, lock, ext. tooth #8	9008072-00

Install the 20 mA option as described in the following steps:

1. Set the TRANS switch on the 20 mA assembly to the NORMAL position. (If the LA120 must provide current to the transmit line, set the switch to the ACT position.)
2. Set the REC switch to the NORMAL position. (If the LA120 must provide current on the receive line set the switch to the ACT position.)
3. Lower the rear cabinet door on the LA120.
4. Disconnect and remove any previously connected plug from J8 on the logic/power board.
5. Slip the 20 mA assembly (2) up through the hole in the floor of the cabinet. Secure with two hex-head screws (4) and washers (5).
6. Connect the 20 mA harness assembly (3) between the jack on the 20 mA logic board (2) and J8 on the logic/power board.

7. Place the LA120 in SET-UP mode. Select and store the following features:
 Modem=1 (FDX, no modem)
 Auto Disconnect=0 (OFF)
8. Connect P1 of the 20 mA external interface cable to the bottom connector on the 20 mA logic board.

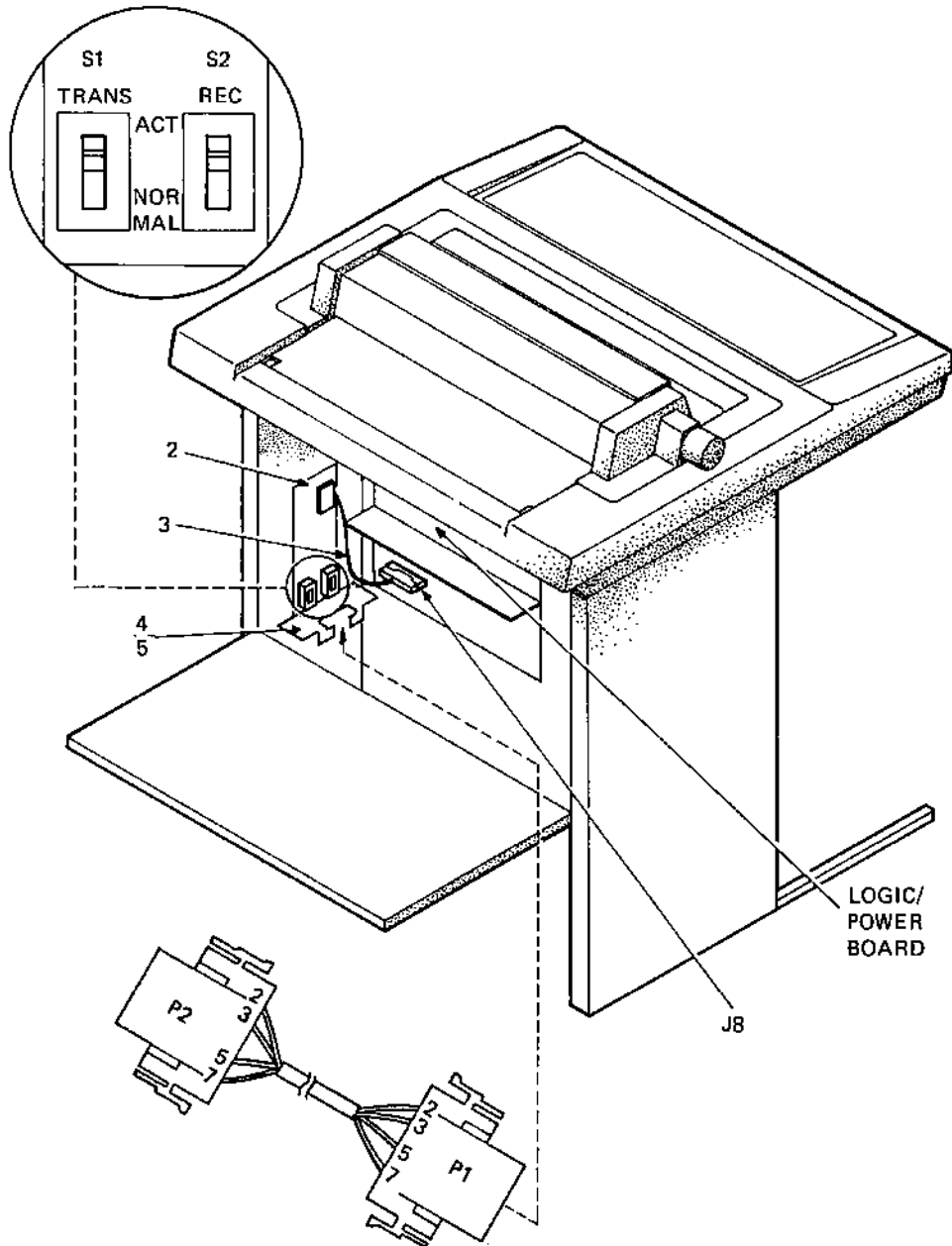

PINNING

FROM	TO
P1-2	P2-3
P1-3	P2-2
P1-5	P2-7
P1-7	P2-5

Test After Installation

After the LA120 is connected to your system you should send and receive data to verify the installation.

Electrical Characteristics

Transmitter	Min	Max	Receiver	Min	Max
Open circuit voltage	5.0 V	50 V	Voltage drop marking	—	2.5 V
Voltage drop marking	—	4.0 V	Spacing current	—	3.0 mA
Spacing current	—	2.0 mA	Marking current	15 mA	50 mA
Marking current	20 mA	50 mA			

Pin Assignments

- 1 – Test Negative
- 2 – Transmit –
- 3 – Receive –
- 5 – Transmit+
- 7 – Receive+
- 8 – Protective ground

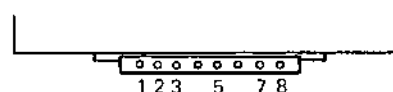

20m A CURRENT LOOP CONNECTOR

MA3380

LA12X-DL EXPANDED BUFFER

Typically a printer receives a series of characters, temporarily stores the characters in a buffer, and then prints the characters one at a time. The LA120 contains a standard 1000 character buffer. This option enables the standard 1000 character buffer to be increased in size to 4000 characters (4K).

An example of the use of this option is an LA120 connected to a video terminal (VT100) whose screen contains 24 lines at 132 characters per line (total of 3168 characters). The LA120 could receive these characters at 9600 baud, store all 24 lines in the buffer, and then print the characters at the printing speed of the LA120 (180 characters per second).

The LA120 buffer control feature (see operator's information) is not affected by this option. If XON XOFF, and large buffer is selected, XOFF will still be generated around 600 characters. The only difference is that the buffer is now 4000 characters instead of 1000 characters.

If XON XOFF, or the equivalent is not used, and the system is operating at high baud rates (for example 2400 baud) for long periods, it may be possible to exceed the 4K buffer capacity.

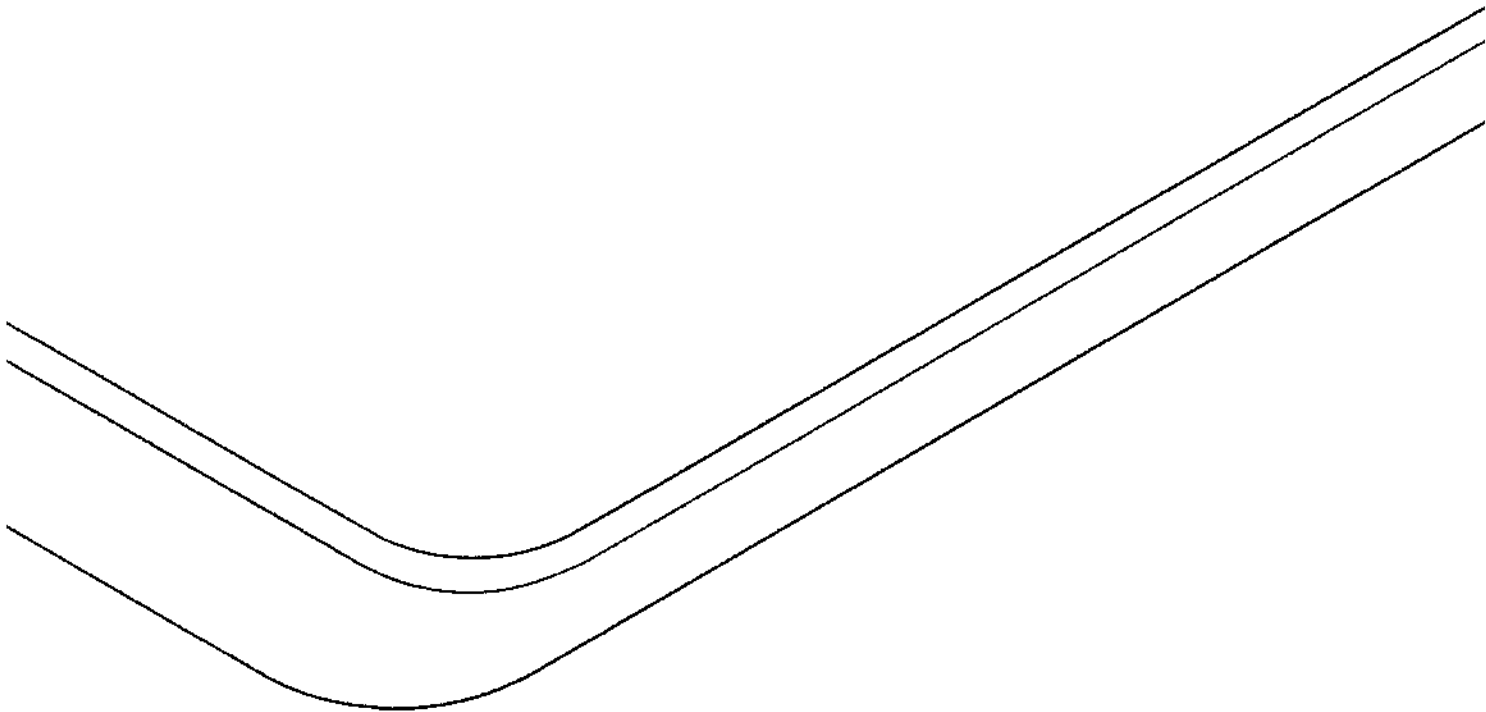

Supplies and Accessories

CHAPTER 6

SUPPLIES and ACCESSORIES

GENERAL

All DIGITAL printer terminals offer improved quality printing and forms-handling versatility. DIGITAL offers a variety of supplies to enhance terminal reliability and make operation easier.

DIGITAL's dye-based ribbon is specifically matched to the print head and eliminates the abrasive problems of carbon and clay based ribbons. Carbon based ribbon tends to wear print head wires and eventually causes poor character legibility. Precise matching of ribbon material and printing methods lengthens print head operating life.

DIGITAL has the paper needed to accommodate up to 132-column print capability and multipart paper adjustments. To eliminate costly printer downtime associated with improperly stacked paper, DIGITAL offers paper collectors that increase printer and operator efficiency by automatically folding and stacking fanfold paper.

LAXX-KB Casters

This set of casters attaches to the rear of the cabinet and facilitates terminal mobility.

LAXX-NC Paper Basket

The paper basket neatly collects and stacks printer paper as it feeds through the printer. The steel constructed unit is 30.5 cm long, 40.6 cm wide, and 33.0 cm high (12 inches long, 16 inches wide, and 13 inches high). It holds up to one complete box of paper. It is shipped with brackets and instructions for easy attachment.

LAXX-KD Wire Shelf

The wire paper shelf collects fanfold paper as it feeds through the printer. The shelf is 26.7 cm long, 45.7 cm wide, and 5.1 cm high (10-1/2 inches long, 18 inches wide, and 2 inches high). No tools or screws are required for attachment. Instructions are included.

LAXX-KC Work Surface Shelf

The durable surface shelf attaches to either the left or right side of the terminal and provides convenient workspace to accommodate data print-outs, printer paper, manuals, etc. The shelf is 61 cm long and 38.7 cm wide (24 inches long and 15-1/4 inches wide). It is shipped with the necessary bars, screws, and instructions for easy attachment.

LAXX-KA Accessories Kit

The kit includes the following accessories:

- 1 LAXX-KB caster set
- 1 LAXX-KD work surface shelf
- 1 LAXX-KD wire shelf

The kit is shipped with the necessary brackets, screws, and instructions for easy attachment.

H981-A Copy Holder

The copy holder improves efficiency, accuracy, and typing speed by furnishing space for viewing reference data at eye level. The copy holder clamps on a desk or table. Minimum eye movement is required as the flexible arm adjusts to the desired position. Attach the copy holder to the LAXX-KC work surface shelf for convenient data reference while using the printer.

12-12375 Dust Cover

The clear vinyl dust cover protects the terminal when not in use.

36-09141-00 Paper

Single-part, white, lined, fanfold, 132-column, 14-7/8 × 11 inches, 2000 sheets per box.

36-09829 Paper

Single-part, white, lined, fanfold, 80-column, 9-7/8 × 11 inches, 2000 sheets per box.

36-05361 Paper

Single-part, white, lined, fanfold, 72-column, 8-1/2 × 11 inches, 2000 sheets per box.

Multipart Forms

All forms are white, lined, fanfold, 14-7/8 × 11 inches.

- 36-09141-01 – 2-part (1600 sets/box)
- 36-09141-02 – 3-part (1000 sets/box)
- 36-09141-03 – 4-part (750 sets/box)
- 36-09141-04 – 6-part (500 sets/box)

36-12153-01 Ribbon

DIGITAL-specified nylon ribbon produces excellent print quality and lengthens print head operating life. Ribbon measures 0.5 inch wide by 60 yards long. Ribbons come individually sealed, 12 per box.

Manuals

The following manuals are available to support your LA120.

Title	Order Number	Contents
LA120 Operator Reference Card	EK-LA120-RG	Summary of SET-UP features
LA120 Pocket Service Guide	EK-LA120-SV	Field Service maintenance information
LA120 Maintenance Manual	EK-LA120-MM	Detailed theory of operation and maintenance information
LA120 User Guide	EK-LA120-UG	Operator, installation, programming, and communication information

Ordering

Purchase orders for supplies and accessories should be forwarded to:
 Digital Equipment Corporation
 Supplies and Accessories Group
 Cotton Road
 Nashua, New Hampshire 03060

Contact your local sales office or call DIGITAL Direct Catalog Sales toll-free (800-258-1710) from 8:30 a.m. to 5:00 p.m. eastern standard time (U.S. customers only). New Hampshire customers should dial (603) 884-6660. Terms and conditions include net 30 days and F.O.B. DIGITAL plant. Freight charges will be prepaid by DIGITAL and added to the invoice. Minimum order is \$35.00. Minimum does not apply when full payment is submitted with an order. Checks and money orders should be made out to Digital Equipment Corporation.

OTHER TERMINALS

The terminal is the vital link between the user and the power of the computer. The right terminal or the enhancement to your terminal can make your work easier, more efficient, and more cost effective. For that reason, DIGITAL offers a full range of video and teleprinter terminals and options that can help you tackle any application.

Video Terminal

For the ultimate in video terminals, look to DIGITAL VT100. It combines exceptional versatility with simplicity of operation. And it's designed to allow a wide range of fast and easy field upgrades to meet your changing needs.

There's a detached typewriter-style keyboard with a flexible 3-wire coiled cord. An 18-key numeric/function keypad on the keyboard permits single keystroke control of application-specific functions. The VT100 fits easily on a standard typewriter table. There's an advanced video option that provides 132-column lines on the screen for easy viewing of wide-line printer reports. Double height/double width characters are selectable line by line for easier reading and text formatting. Smooth scrolling a scan at a time lets your operators read new lines at a reasonable speed. Divided-screen displays; blinking, underlining, double intensity, and normal or reverse video character attributes; keyboard and/or computer-settable tab stops; built-in self-test diagnostics; pictorial capability; and many, many more.

Intelligent Video Terminal

At the head of the VT100 class are DIGITAL'S intelligent PDT-11 terminals. The PDT family includes three programmable data terminals: the PDT-11/110, the PDT-11/130, and the PDT-11/150. With their PDP-11 compatible processors and RT-11 operating system, the PDTs permit you to draw on a wide range of existing software.

Local mass storage is available on the PDT-11/130 in the form of 524K bytes of storage provided in dual mini cartridges. Housed within the same VT100 shell, these mini cartridges are file-structured system devices. The PDT-11/150 lets you combine the functionality of the PDT-11 with the dual floppy disk storage of any DIGITAL terminal. With its four ports, the 11/150 allows considerable system expansion. Add a terminal controller if you want the flexibility of up to four terminals. For hardcopy, add a printer to the printer port. There's a third port for an EIA link to a host computer.

LA34/LA38 DECwriter IV

Everything about the 300 baud desktop terminals adds up to convenience. They are smaller, lighter, and quieter than many typewriters. They have sculptured, typewriter-like keys, and a cartridge for simple ribbon changes. All features are set at the keyboard, including four character width adjustments. They also have automatic self-test diagnostics.

Your comments and suggestions will help us in our continuous effort to improve the quality and usefulness of our publications.

What is your general reaction to this manual? In your judgment is it complete, accurate, well organized, well written, etc.? Is it easy to use? _____

What features are most useful? _____

What faults or errors have you found in the manual? _____

Does this manual satisfy the need you think it was intended to satisfy? _____

Does it satisfy *your* needs? _____ Why? _____

Please send me the current copy of the *Technical Documentation Catalog*, which contains information on the remainder of DIGITAL's technical documentation.

Name _____ Street _____

Title _____ City _____

Company _____ State/Country _____

Department _____ Zip _____

Additional copies of this document are available from:

Digital Equipment Corporation
Accessories and Supplies Group
Cotton Road
Nashua, NH 03060
Attention: Documentation Products
Telephone: 1-800-258-1710

Order No. EK-LA120-UG-003

Fold Here

Do Not Tear - Fold Here and Staple

digital



No Postage
Necessary
if Mailed in the
United States

BUSINESS REPLY MAIL

FIRST CLASS PERMIT NO. 33 MAYNARD, MA.

POSTAGE WILL BE PAID BY ADDRESSEE

**Digital Equipment Corporation
Communications Development and Publishing Services
129 Parker Street, PK3-1/T12
Maynard, MA 01754**



INDEX

A	
Accessories.....	103
Acoustic coupler.....	94
Active column.....	74
Active line.....	74
Active position.....	74
Alarm indicators.....	9
ALT CHAR SET light.....	3
Alternate keypad mode.....	46,79
ANSI.....	71
Answerback.....	36
Entering message.....	37
Jumper.....	62
Transmitting message.....	36
APL character set.....	83
Auto answerback.....	37
Auto disconnect.....	40
Auto line feed.....	42
Auto new line at right margin.....	41
Auto repeat.....	30,86
Auto repeat rate.....	30

B	
BACK SPACE key.....	5
Baud rate (speed).....	34
Bell.....	6,9
Approaching right margin.....	10
Generating code for.....	80
Indications.....	9
Volume.....	31
BREAK key.....	6,89
Control.....	38
High water mark.....	38
Low water mark.....	38
Overflow.....	92

C	
Cabling.....	63
EIA.....	63
20mA current loop.....	99
CAPS LOCK key.....	6
Carriage adjustment lever.....	8
Characters per inch.....	25
Example.....	25
Selection.....	25
Checkout procedure.....	62
Clearances, installation.....	59
Comfort features.....	103
Communications features.....	32
Console, operator's.....	2
Control characters.....	5,80,87
Cover interlock switch.....	7
Cover open.....	60
CTRL key.....	6,87
CTS (clear to send) light.....	3
Current loop interface.....	94

D	
Data bits, number of.....	44
Data Set Ready.....	63
Loss of.....	94
DELETE key.....	5
DSR (data set ready) light.....	3

E	
EIA.....	63
ENTER key.....	7
ESC key.....	5
Escape sequences.....	72,75

F

Factory stored settings.....	50
Fill characters.....	84
Fill time formulas.....	85
Foreign character sets.....	66,74
Form feed code, generating.....	80,82
Form length.....	78
Form setup example.....	84
Form setup sample.....	16
Full duplex.....	90
Full duplex break.....	91
Full duplex hang up.....	90
Fuse, AC.....	11,55

H

Half duplex.....	43,92,95
Half duplex break.....	93
Hang up phone line.....	94
Head gap.....	54
Head jam.....	9
HERE IS key.....	3
High water mark.....	38
Horizontal form adjustment.....	27,29
Horizontal margins.....	27,76
Clearing.....	28
Setting right.....	28
Setting left.....	28
Horizontal pitch.....	75
Horizontal tabs.....	76
Clearing all.....	29
Clearing single.....	29
Setting.....	29

I

Initial calling state (HDX).....	92
Initial direction determination.....	92
Installation and configuration.....	59
Interfaces.....	63
EIA.....	63
20mA current loop.....	99

K

Key click.....	32
Keyboard character set.....	39
Baud.....	5
Clear All.....	4
Left/Top Mar.....	4
Mar Clear.....	5
Recall/Store.....	5
Rt/Bot Mar.....	5
Status.....	5
Tab Clear.....	4
Tab Set.....	4
TOF (top of form).....	4

L

Last character view (LCV).....	31
Lights.....	3
Alt Char Set.....	3
CTS (clear to send).....	3
DSR (data set ready).....	3
Local.....	3
On Line.....	3
Paper Out.....	3
Set-Up.....	3
LINE FEED key.....	4
LINE/LOCAL key.....	3
Lines per inch.....	19
Example.....	19
Selection.....	19,20
Line feed newline mode.....	75
Loading paper/forms.....	55
Local echo.....	41
LOCAL FORM FEED key.....	3
LOCAL light.....	3
LOCAL LINE FEED key.....	4
Low water mark.....	38

M

Modem.....	42
Modem control protocols.....	91
Modem setup feature description.....	94
Modem, summary of features.....	96
Modems.....	95
Bell Telephone.....	95
Vadic 3400.....	95
Multipart forms.....	104

N

Numeric display.....	3
Numeric keypad.....	7

O

ON LINE light.....	3
ON/OFF, power switch.....	7
Operator comfort features.....	30
Operator reference card.....	13
Operator troubleshooting table.....	11
Operator's console.....	2
Optional character sets.....	74

P

Packing procedures.....	61
Paper adjust knob.....	8
Paper/Forms.....	55
Initial loading.....	55
Reloading.....	56
Paper/Forms loading.....	55
Paper, out of.....	96

PAPER OUT light.....	3
Parity, setting and checking.....	44
Parity symbol.....	44
Permanently stored settings.....	51
PF1, PF2, PF3, PF4 keys.....	7
Power ON/OFF switch.....	7
Print impression adjustment.....	54
Print character set.....	39,72
Printer new line character.....	45
Product identification.....	79
Protocol, communications.....	91
R	
Recall settings.....	51
Restraint mode.....	92
RETURN key.....	5
Reverse channel.....	93
Ribbon installation.....	54
RS232C.....	63
S	
Sample form.....	16
Illustration.....	16
Using setup commands.....	18
Using escape sequences.....	
Secondary channel.....	43
Self test.....	53
Nonprinting.....	53
Printing.....	53
Sample printout.....	53
SET-UP commands, by letter.....	
A.....	37
B.....	38
C.....	40
D.....	40
E.....	41
F.....	20
G.....	31
H.....	26
I.....	50
J.....	41
K.....	22,25,32
L.....	42
M.....	42
N.....	39,47
O.....	47,48
P.....	44
Q.....	43
R.....	30
S.....	43
T.....	53
U.....	48
V.....	19
W.....	45
X.....	45
Y.....	46
Z.....	31
SET-UP key.....	4
SET-UP label.....	52
SET-UP light.....	3
SET-UP mode.....	18
SHIFT keys.....	6
Site considerations.....	59
Space bar.....	5
Specifications.....	66
Speed control mode.....	92
RS232.....	63
EIA.....	63
Status message.....	52
Store settings.....	51
Store, recall and status features.....	49,51
Supplies.....	103
Synchronization.....	84
T	
TAB key.....	5
Horizontal.....	27
Vertical.....	22,24
Temporarily stored settings.....	49
Testing and troubleshooting.....	10
Top of form.....	4,21
Tractor adjust knobs.....	8
Troubleshooting.....	10
Turnaround characters.....	93
U	
Unpacking and inspection.....	60
V	
Vertical forms adjustment.....	8,22
Vertical margins.....	22,78
Clearing.....	24
Setting bottom.....	23
Setting top.....	23
Vertical pitch.....	77
Vertical tabs.....	24,78
Clearing all.....	25
Clearing single.....	25
Setting.....	23
VIEW key.....	7,89
Voltage Selector Switch.....	61
Volume, bell.....	31
X	
XON/XOFF.....	45

NOTES

INSTALLATION, WARRANTY, AND SERVICE INFORMATION

INSTALLATION/WARRANTY

For customers who have purchased directly from DIGITAL, reference the sales agreement for installation and warranty terms purchased with this terminal.

For customers who have purchased, leased, or rented from a vendor other than DIGITAL, contact your vendor for information regarding installation and warranty terms purchased with this terminal.

DIGITAL SERVICES

A wide range of maintenance and customer services are available from DIGITAL for your terminal. Through use of these services, you can design a plan which meets your service needs, from complete DIGITAL maintenance to complete self-maintenance. Vendors supplying DIGITAL products may use these services as factory backup support.

- **On-Site Service**

DIGITAL offers responsive, low cost, factory-level maintenance performed at your site by trained Terminals Service Specialists through:

- Service Agreements which cover all your maintenance needs to include priority response; all labor, materials and travel for a fixed monthly charge.
- Per Call Service which is provided on a "time" and "materials" basis and can serve as a back-up to your own in-house maintenance programs.

- **Off-Site Service**

For those customers who have a significant level of troubleshooting expertise, but require Field Service assistance for the repair of components, DIGITAL has established a worldwide network of Product Repair Centers (PRCs) and the Customer Returns Area (CRA). Through a wide array of service product offerings this logistics network offers cost effective services to include:

- Module Mailer™
- Fixed Price Exchange
- Product Refurbishment

- **Spare Parts**

In an effort to further assist those customers who choose to perform their own computer maintenance, DIGITAL's Customer Spares organization is committed to providing thorough and timely spares support through:

- Spares Inventory Planning
- Component/Subassembly Spares
- Maintenance Test Equipment
- Maintenance Documentation Service
- Emergency Spare Parts

- **Training**

DIGITAL offers hardware maintenance courses through the Educational Services group at any of our 17 worldwide training centers; or depending on your specific training requirements, courses can be provided in your own facilities.

- **Terminal Supplies**

DIGITAL offers a variety of supplies to enhance terminal reliability and to make operation easier. Everything from furniture accessories, (cabinets, tables, etc.) to terminal supplies, such as paper, ribbons, diskettes, cassettes, labels, and many other items, as illustrated in the Supplies Brochures, are available through DIGITAL and may be obtained by dialing the toll-free number below. All orders may be placed via the toll-free number (800-258-1710) and will be processed within 24 hours (U.S. only - with the exception of Hawaii and Alaska).

To obtain further information concerning any of the customer services available, fill out the attached card or write:

DIGITAL EQUIPMENT CORPORATION

129 Parker Street
Maynard, MA 01754

ATTN: Customer Services Marketing - PK3-2/S25



digital