

IEEE-100 BUS

FUNCTION PIN#

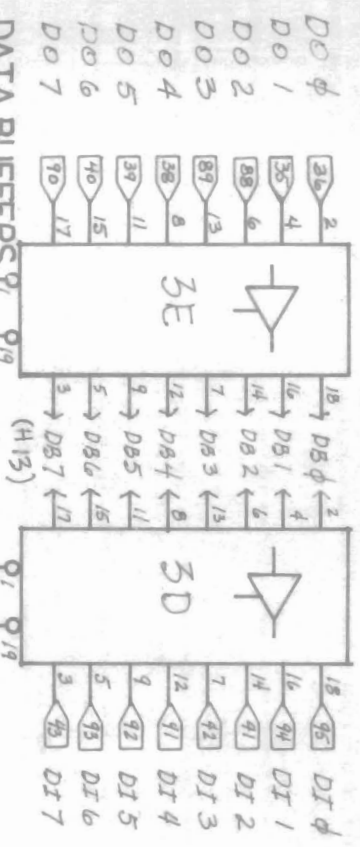

PIN# FUNCTION

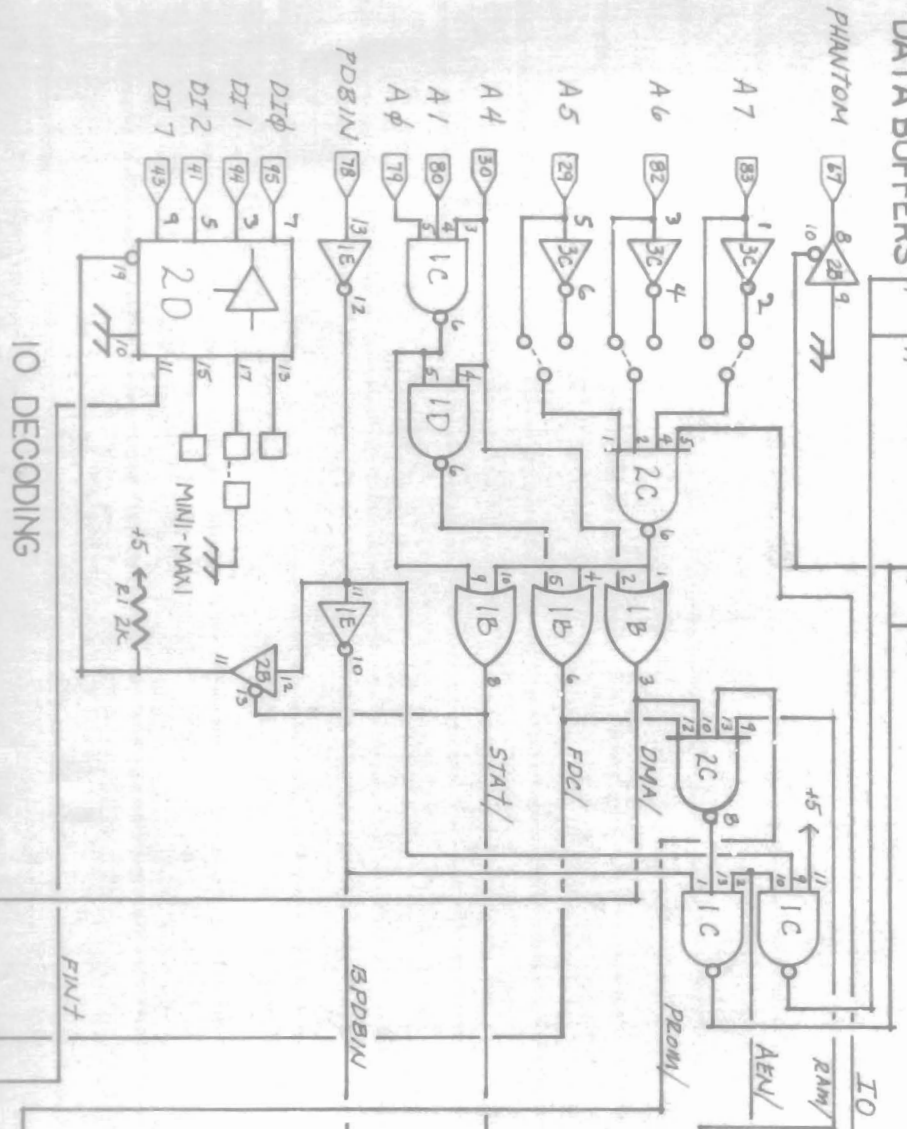

IO DECODING

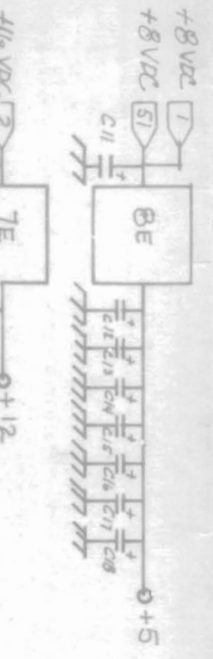

FUNCTION PIN#

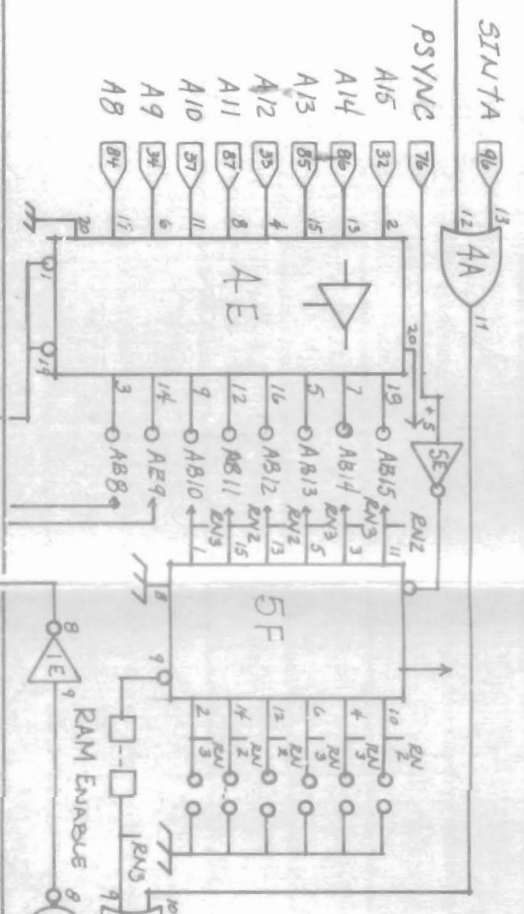

ADDRESS BUFFERS

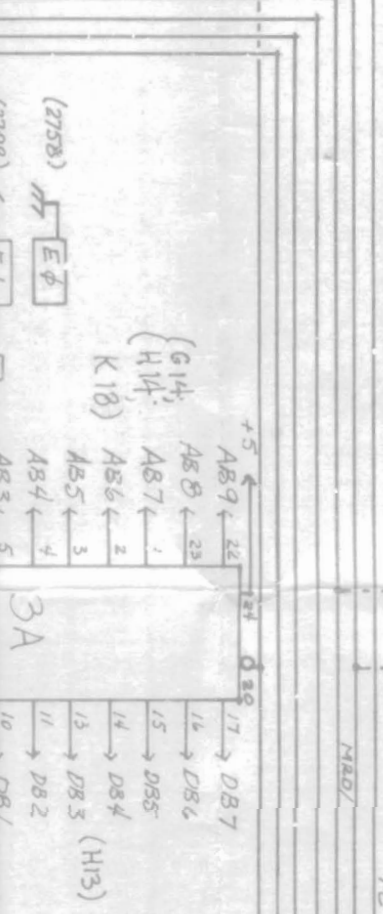
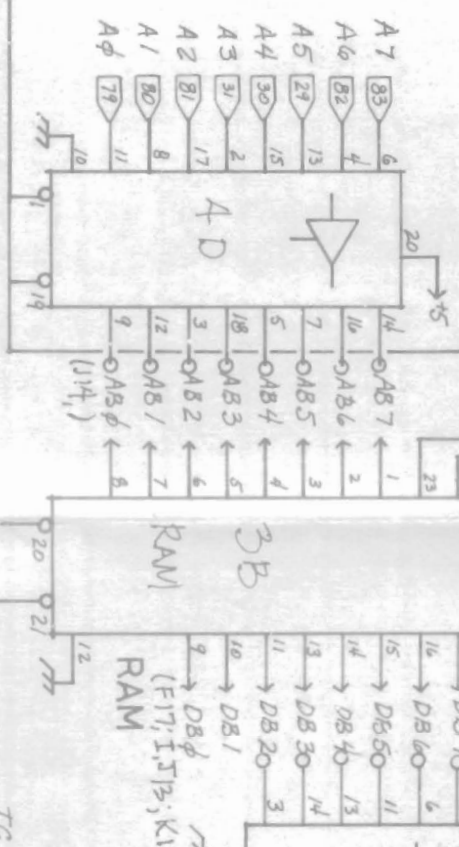

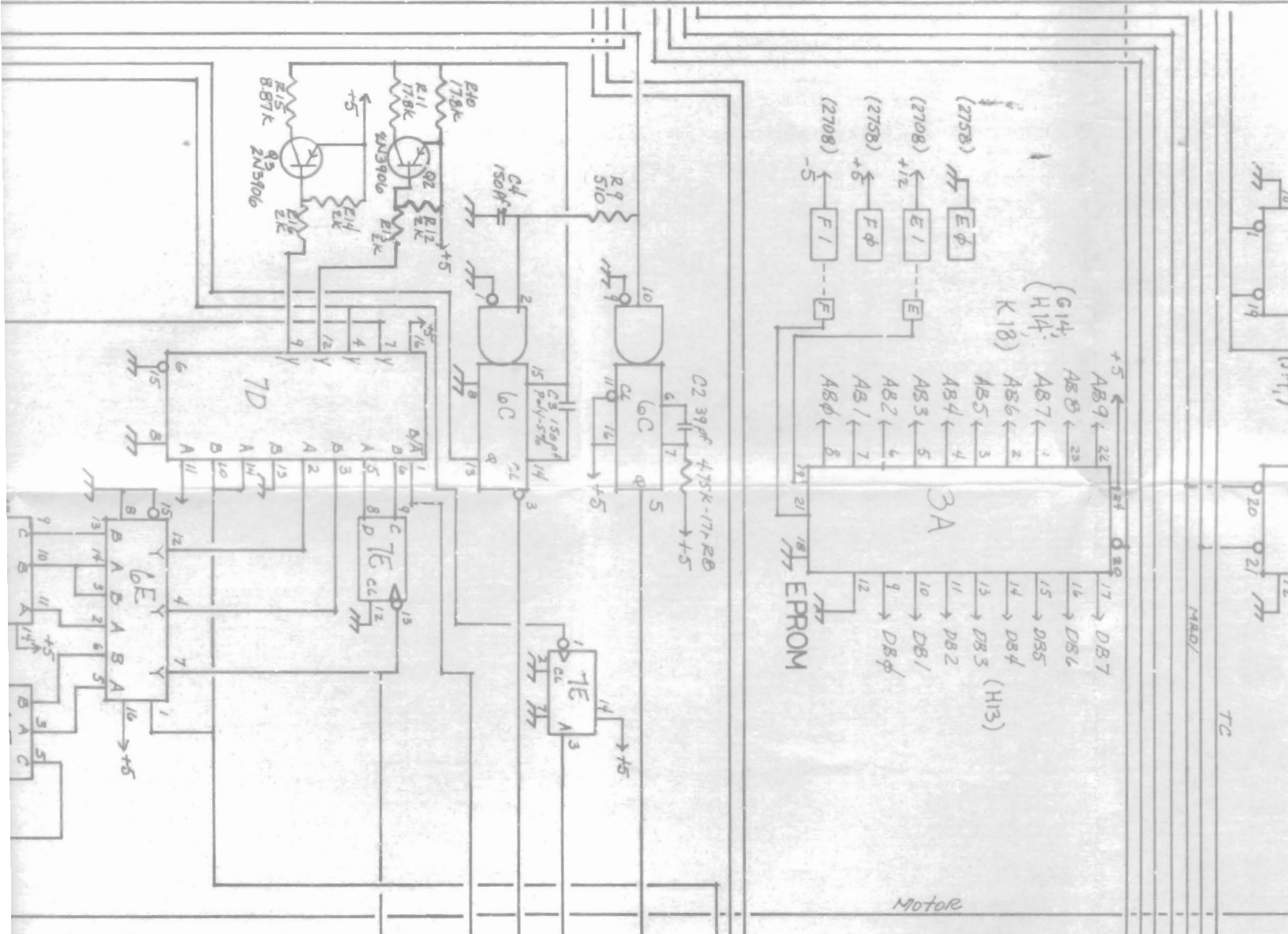
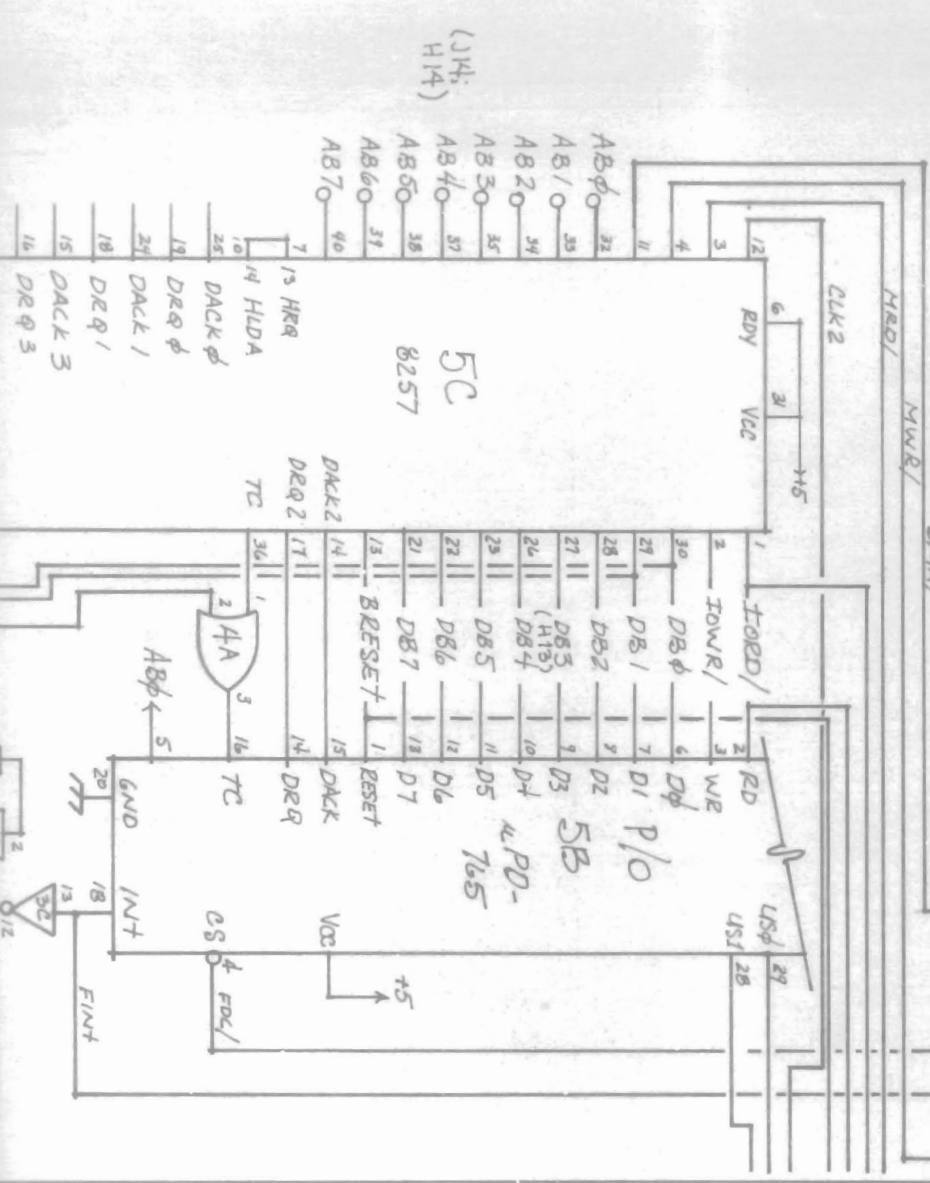
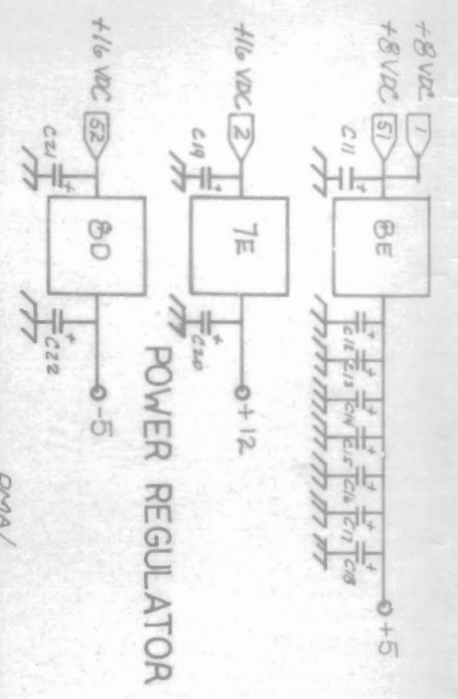
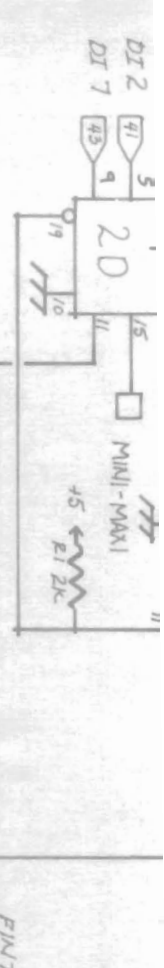

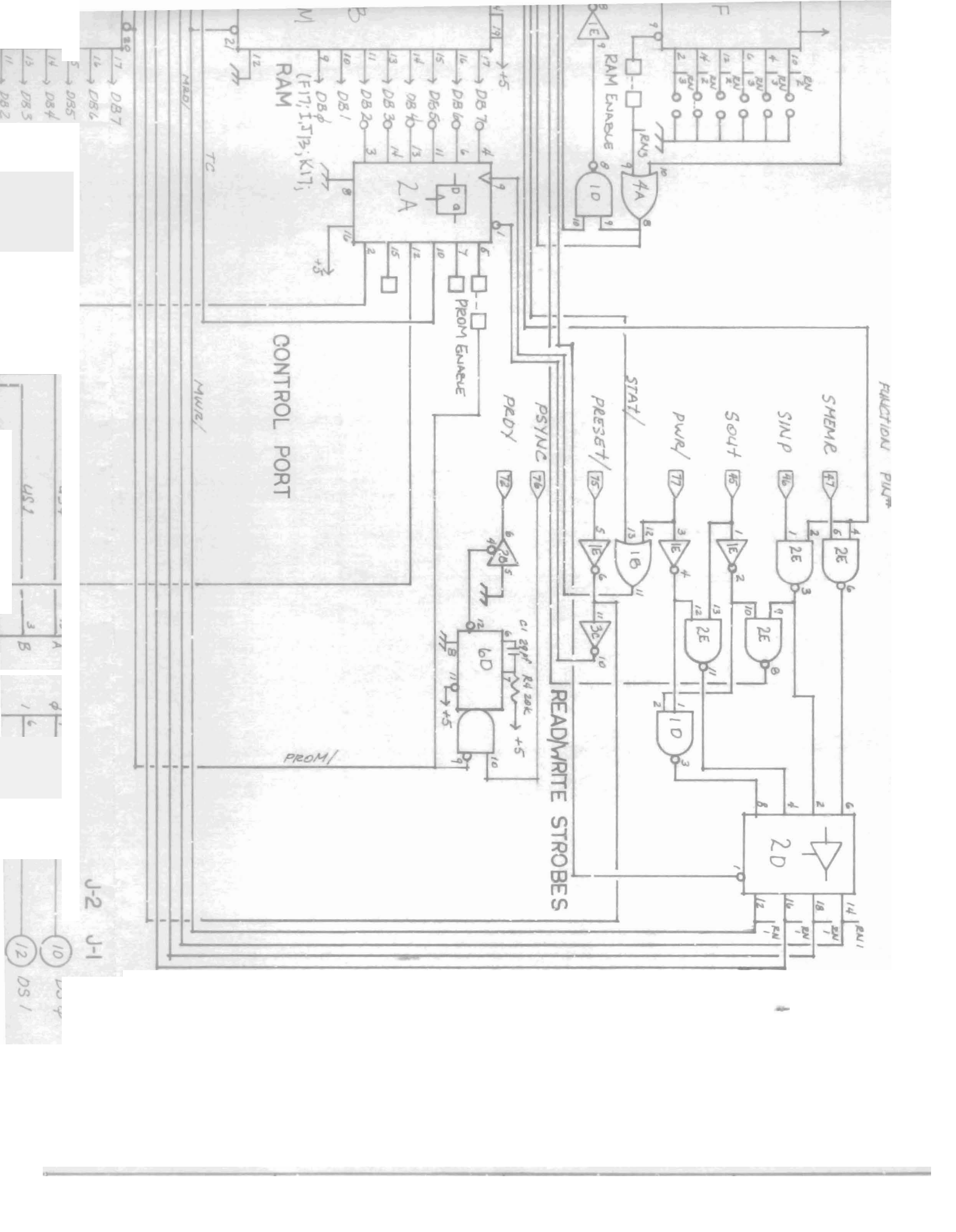

17 → D4
16 → D18

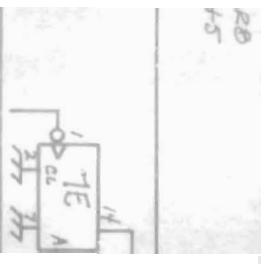
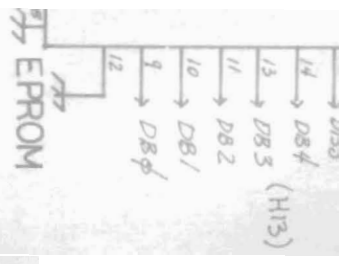

Motor

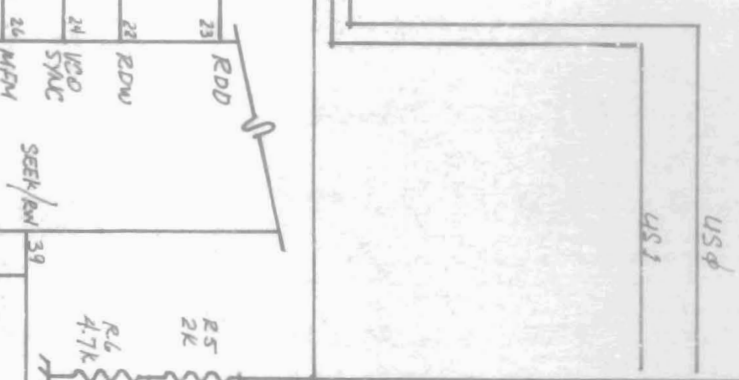

uPD-765
SB
P/O

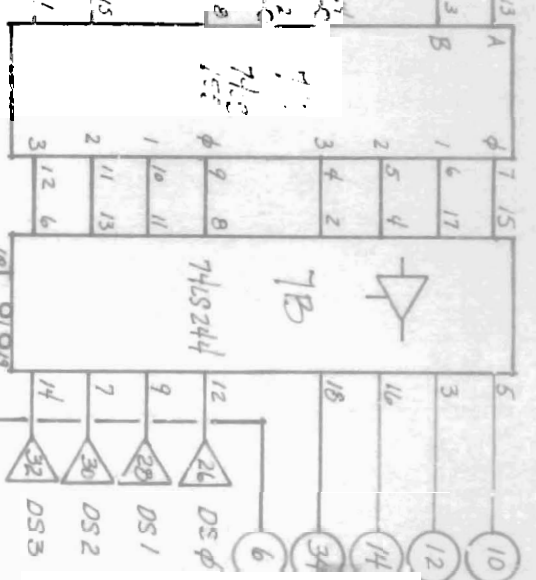

READY for MINI-DRIVES
DRIVE SELECT

J-2 J-1

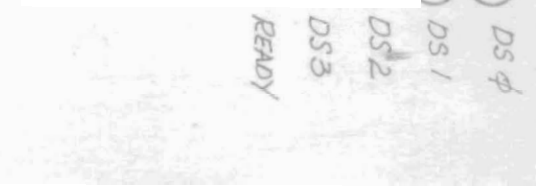

ABOVE TRACK
4/5

DUAL SIDED

HEAD 1

HEAD LOAD

INDEX

READY

DIRECTION

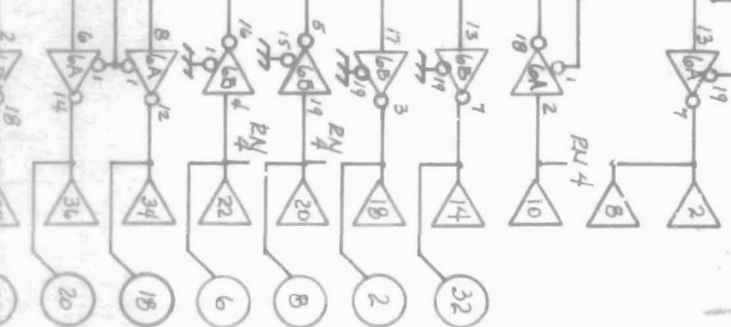
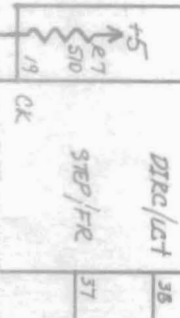

DATA

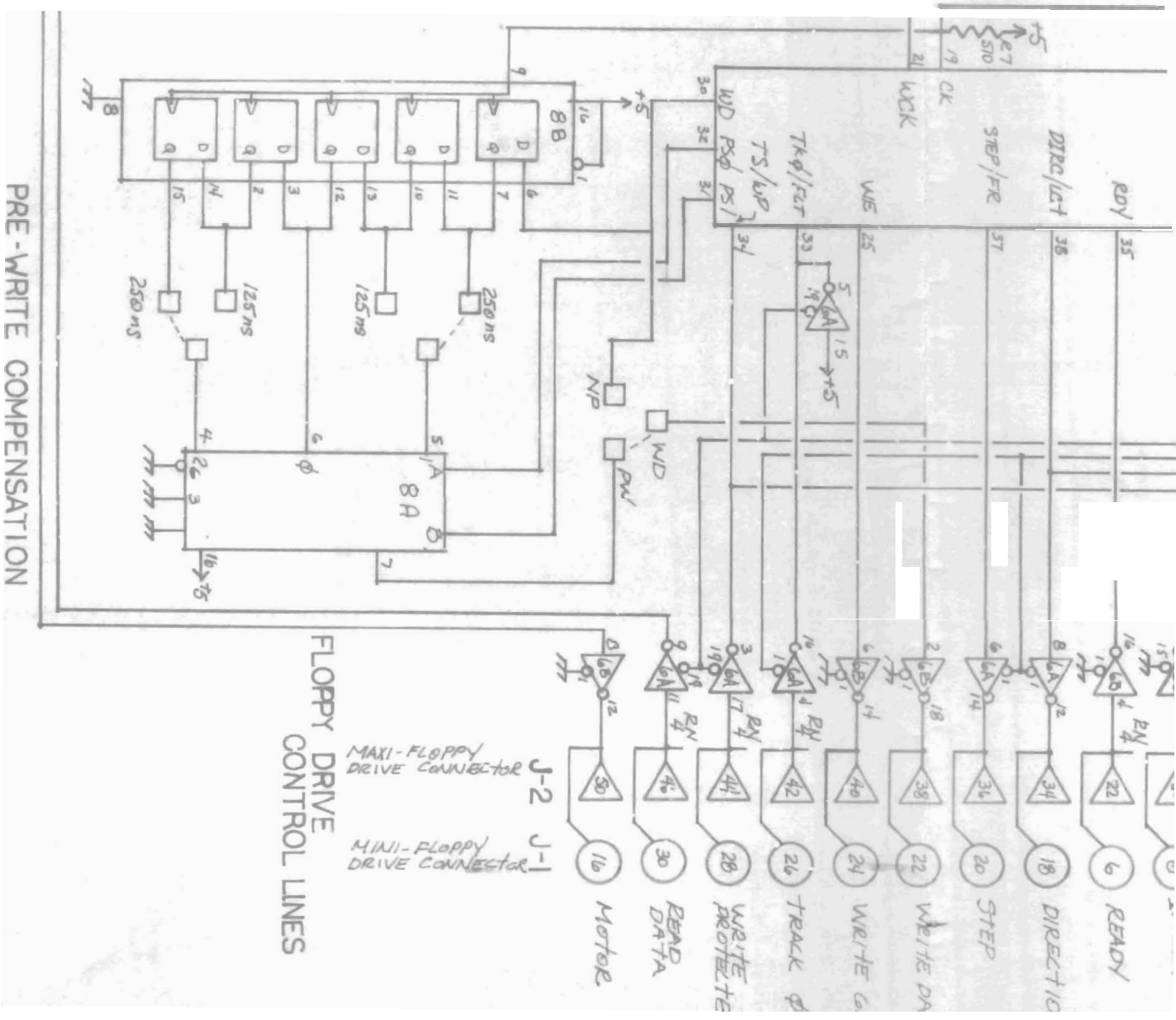
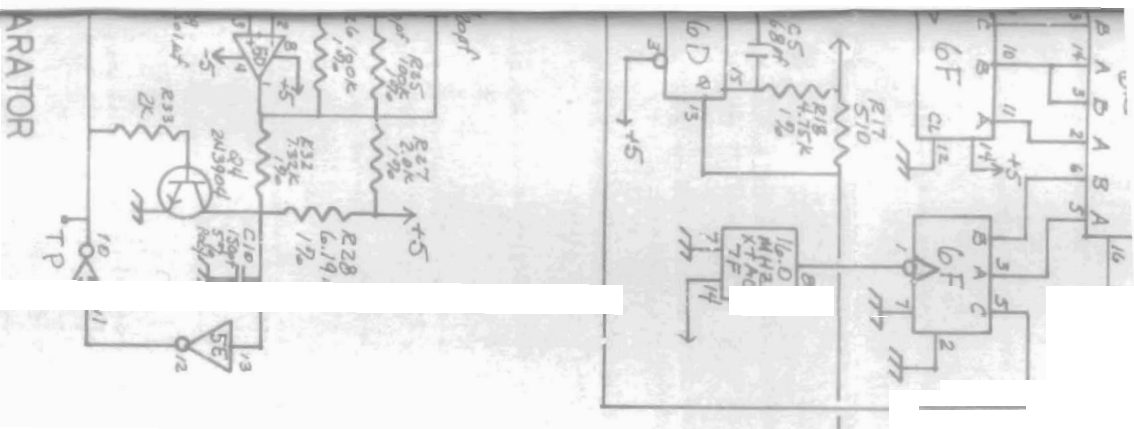

September 1, 1980 KLB REV