

1 TTY CAS VIDEO ETI
 2 CAS TTY CAS VIDEO ETI
 3 TTY CAS VIDEO ETI
 4 CAS TTY CAS VIDEO ETI
 5 VIDEO ETI
 6 TTY CAS VIDEO ETI
 7 TTY CAS VIDEO ETI
 8 TTY CAS VIDEO ETI
 9 TTY CAS VIDEO ETI
 10 TTY CAS VIDEO ETI
 11 TTY CAS VIDEO ETI
 12 TTY CAS VIDEO ETI
 13 TTY CAS VIDEO ETI
 14 TTY CAS VIDEO ETI
 15 TTY CAS VIDEO ETI
 16 TTY CAS VIDEO ETI
 17 TTY CAS VIDEO ETI
 18 TTY CAS VIDEO ETI
 19 TTY CAS VIDEO ETI
 20 TTY CAS VIDEO ETI
 21 TTY CAS VIDEO ETI
 22 TTY CAS VIDEO ETI
 23 TTY CAS VIDEO ETI
 24 TTY CAS VIDEO ETI
 25 TTY CAS VIDEO ETI
 26 TTY CAS VIDEO ETI
 27 TTY CAS VIDEO ETI
 28 TTY CAS VIDEO ETI
 29 TTY CAS VIDEO ETI
 30 TTY CAS VIDEO ETI
 31 TTY CAS VIDEO ETI
 32 TTY CAS VIDEO ETI
 33 TTY CAS VIDEO ETI
 34 TTY CAS VIDEO ETI
 35 TTY CAS VIDEO ETI
 36 TTY CAS VIDEO ETI
 37 TTY CAS VIDEO ETI
 38 TTY CAS VIDEO ETI
 39 TTY CAS VIDEO ETI
 40 TTY CAS VIDEO ETI
 41 TTY CAS VIDEO ETI
 42 TTY CAS VIDEO ETI
 43 TTY CAS VIDEO ETI
 44 TTY CAS VIDEO ETI
 45 TTY CAS VIDEO ETI
 46 TTY CAS VIDEO ETI
 47 TTY CAS VIDEO ETI
 48 TTY CAS VIDEO ETI
 49 TTY CAS VIDEO ETI
 50 TTY CAS VIDEO ETI
 51 TTY CAS VIDEO ETI
 52 TTY CAS VIDEO ETI
 53 TTY CAS VIDEO ETI
 54 TTY CAS VIDEO ETI
 55 TTY CAS VIDEO ETI
 56 TTY CAS VIDEO ETI
 57 TTY CAS VIDEO ETI
 58 TTY CAS VIDEO ETI
 59 TTY CAS VIDEO ETI
 60 TTY CAS VIDEO ETI
 61 TTY CAS VIDEO ETI
 62 TTY CAS VIDEO ETI
 63 TTY CAS VIDEO ETI
 64 TTY CAS VIDEO ETI
 65 TTY CAS VIDEO ETI
 66 TTY CAS VIDEO ETI
 67 TTY CAS VIDEO ETI
 68 TTY CAS VIDEO ETI
 69 TTY CAS VIDEO ETI
 70 TTY CAS VIDEO ETI
 71 TTY CAS VIDEO ETI
 72 TTY CAS VIDEO ETI
 73 TTY CAS VIDEO ETI
 74 TTY CAS VIDEO ETI
 75 TTY CAS VIDEO ETI
 76 TTY CAS VIDEO ETI
 77 TTY CAS VIDEO ETI
 78 TTY CAS VIDEO ETI
 79 TTY CAS VIDEO ETI
 80 TTY CAS VIDEO ETI
 81 TTY CAS VIDEO ETI
 82 TTY CAS VIDEO ETI
 83 TTY CAS VIDEO ETI
 84 TTY CAS VIDEO ETI
 85 TTY CAS VIDEO ETI
 86 TTY CAS VIDEO ETI
 87 TTY CAS VIDEO ETI
 88 TTY CAS VIDEO ETI
 89 TTY CAS VIDEO ETI
 90 TTY CAS VIDEO ETI
 91 TTY CAS VIDEO ETI
 92 TTY CAS VIDEO ETI
 93 TTY CAS VIDEO ETI
 94 TTY CAS VIDEO ETI
 95 TTY CAS VIDEO ETI
 96 TTY CAS VIDEO ETI
 97 TTY CAS VIDEO ETI
 98 TTY CAS VIDEO ETI
 99 TTY CAS VIDEO ETI
 100 TTY CAS VIDEO ETI

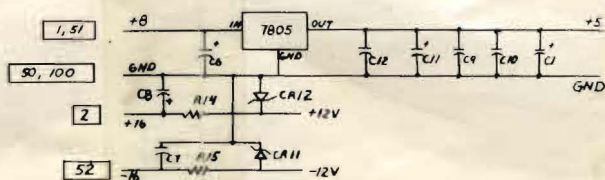

CONNECTION POINT

TTY ACIA

VIDEO ACIA

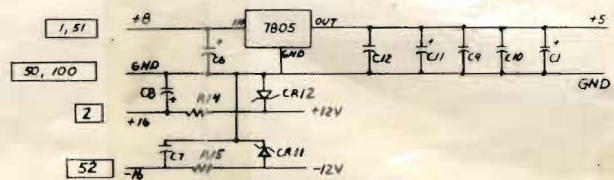
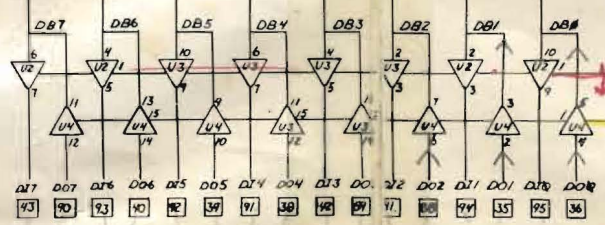
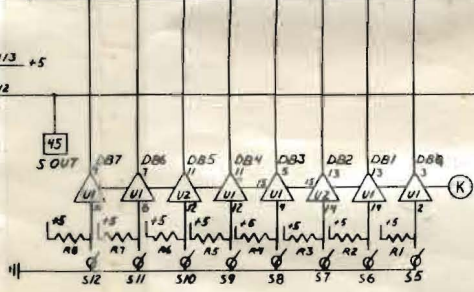
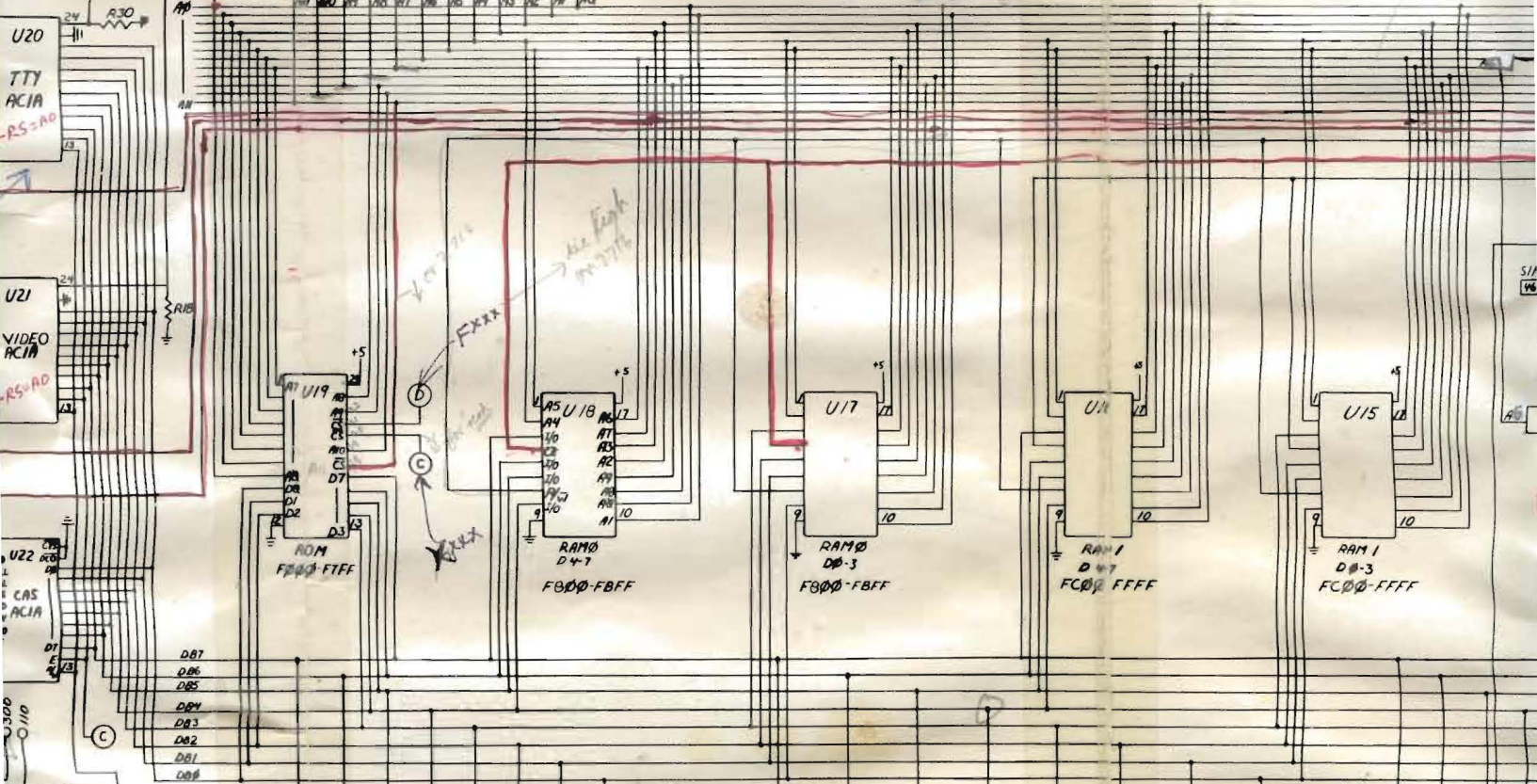
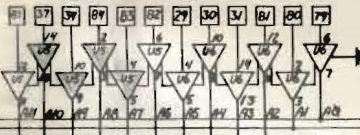
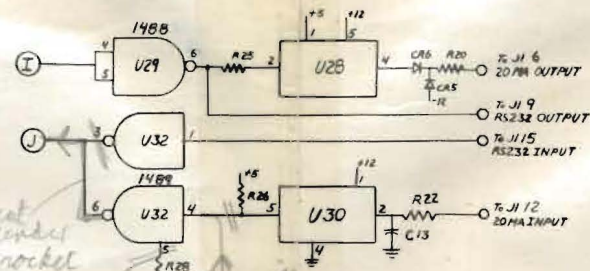
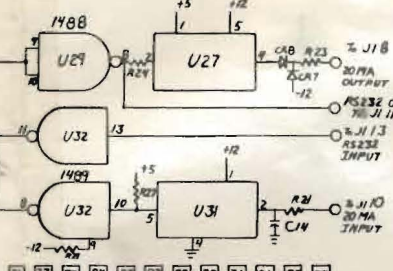

CONNECTION POINT	LOCATION
A	B8
B	C8
C	D3, E9, F1, G10
D	D3, E8
E	A9, E0
F	A9, E0
G	A9, E0
H	B11, E0
I	A4, D0
J	B4, D0
K	C7, D0, G3

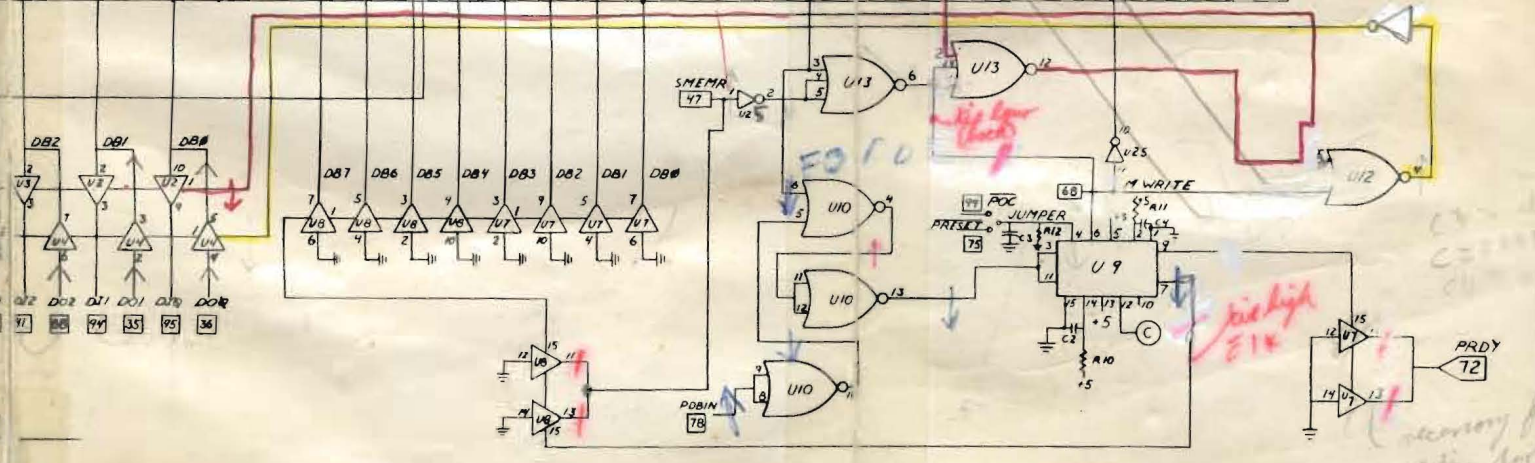
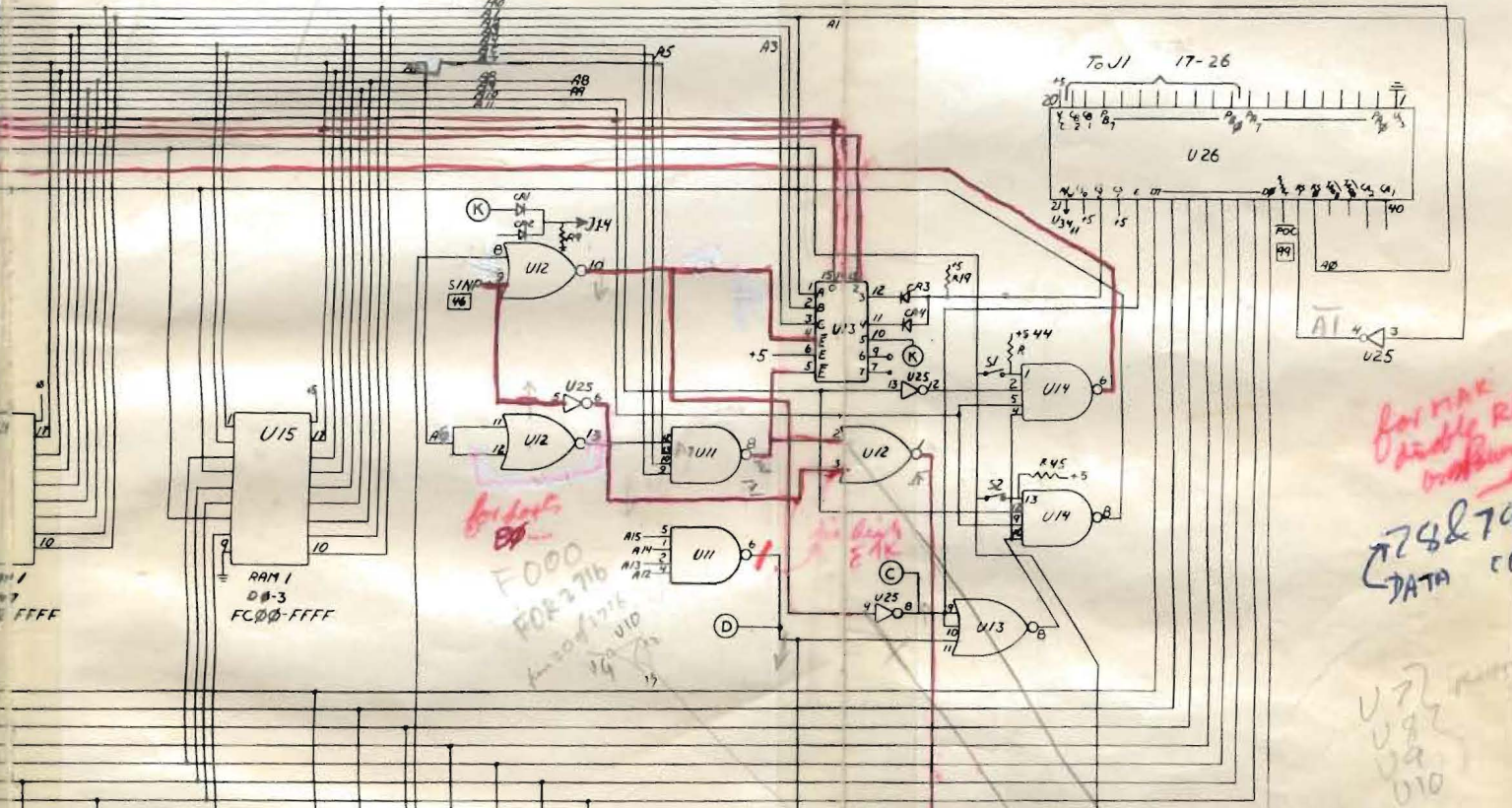
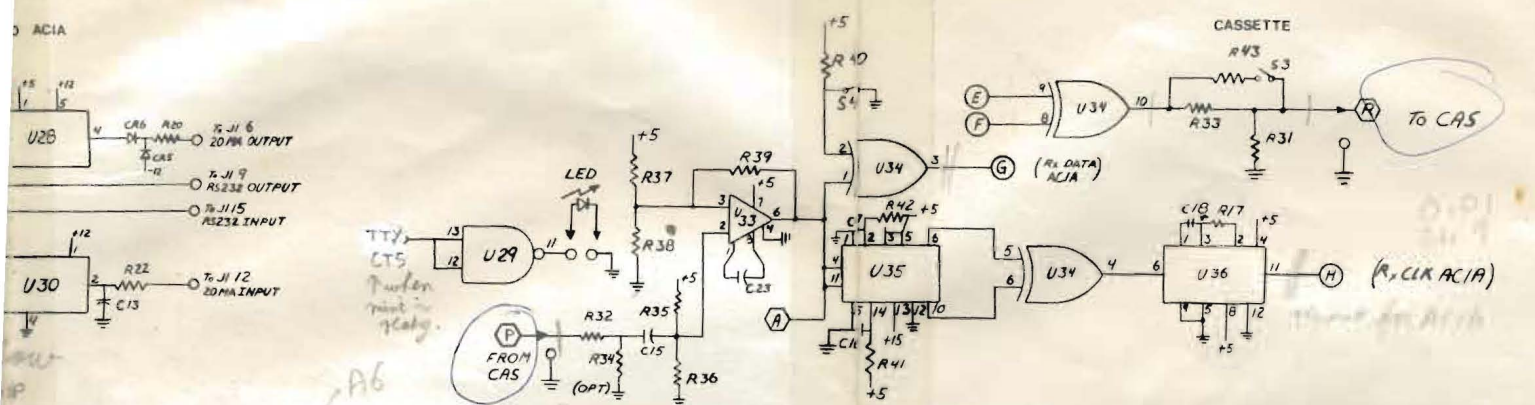

for data EP
F000
FOR 2716
for data EP

for max available RAM
742 & 744
DATA CONTROL

NOTES:
 DBA - DATA BUS OF S/M B
 DI - DATA TO PROCESSOR
 DO - DATA FROM PROCESSOR
 □ 5-100 BUS PIN NO.

SYSTEM MONITOR BOARD

TECHNICAL DESIGN LABS

REVISED 4/25/77	DWN BY JOHN D WEST
NO	DATE 1/27/77