

# **16K RAM OPERATION**

PolyMorphic  
Systems

460 Ward Drive Santa Barbara California 93111 (805) 967-2351

This manual is PolyMorphic Systems part no. 810119.

Copyright 1977, Interactive Products Corporation.

Card  
Revision C

The PolyMorphic Systems 16K RAM card provides 16,384 bytes of read/write storage. The card uses proven 4K dynamic RAM chips and provides "transparent" refresh circuitry onboard (no wait states). Each card has been tested for 72 hours before shipment. This includes 48 hours of GALPAT and checkerboard testing at high temperatures with no errors. This card should provide years of trouble-free service in your 8080-based S-100 system.

#### THEORY OF OPERATION

Refresh cycles are inserted during the T4 state of the M1 cycle of the 8080 central processor or during a hold or halt state of more than 15 cycles. Memory read cycles are initiated by the coincidence of the phase 1 clock, PSYNC, and DO7 (MREAD status). Write cycles are initiated by the leading edge of MWRITE. If the card is used with systems using DMA (Direct Memory Access), the DMA controller must provide the proper status bits on the DO bus during SYNC time. The bus timing must match that of an 8080 processor. Contact the manufacturer or distributor of the DMA controller before attempting to use the 16K RAM card with a DMA device.

#### ADDRESSING

Consult the user's manual for your computer to determine the correct address for this memory card. For POLY 88 or System 88 computers, the card should be addressed just above the present top of memory. If your system uses only 16K cards, the first card should be addressed at 2000H, the second card at 6000H, and the third card at A000H.

The 16K RAM card may be addressed to any 4K boundary within the 64K address space of the S-100 bus and will occupy the next 16K bytes of storage space. (If addressed at 2000H, the RAM will occupy 2000-5FFFH.) The address switches are located in the lower left corner of the card. Up to seven switches may be present, but only the top four are used. These switches are numbered 1 through 4 from the top of the card. The switch settings for various addresses are given below. Rocker switches are ON when the on or plus side of the rocker switch is pressed down. For purposes of reference, note the numbers down one side of the card and across the top. These numbers indicate the addresses of the memory chips within the 16K block. Numbers down the side indicate byte address; row 0 on the card is addressed in the first 4K of the block, row 1 in the next, and so on. Numbers across the top correspond to the bits in each byte. Column 0 contains the first bit in every byte, column 1 the second, etc.

Switch Settings  
(X=on, blank=off)

Address	1	2	3	4
0000				
4K 1000	X			
8K 2000		X		
12K 3000	X	X		
16K 4000			X	
20K 5000	X		X	
24K 6000		X	X	
28K 7000	X	X	X	
32K 8000				X
36K 9000	X			X
40K A000		X		X
44K B000	X	X		X
48K C000			X	X
52K D000	X		X	X
56K E000		X	X	X
60K F000	X	X	X	X

If addressed higher than C000H, the memory above FFFFH will appear in the lower end of the address space. (If set at E000 it will appear at E000-FFFFH and 0000-1FFFH.)

The RAM card may now be plugged into your system backplane. Consult the user's manual for your computer for card insertion instructions.

#### SPECIFICATIONS

Memory Size:	16,384 Bytes
Access Time:	375 nS (from 01)
Cycle Time:	525 nS
Wait States:	0
Power Consumption:	+16 to 20V @ 200 mA max. (active)
	+16 to 20V @ 90 mA max. (standby)
	+8 to 10V @ 600 mA max.
	-16 to 20V @ 24 mA max.
Card Size:	5.5" x 10"

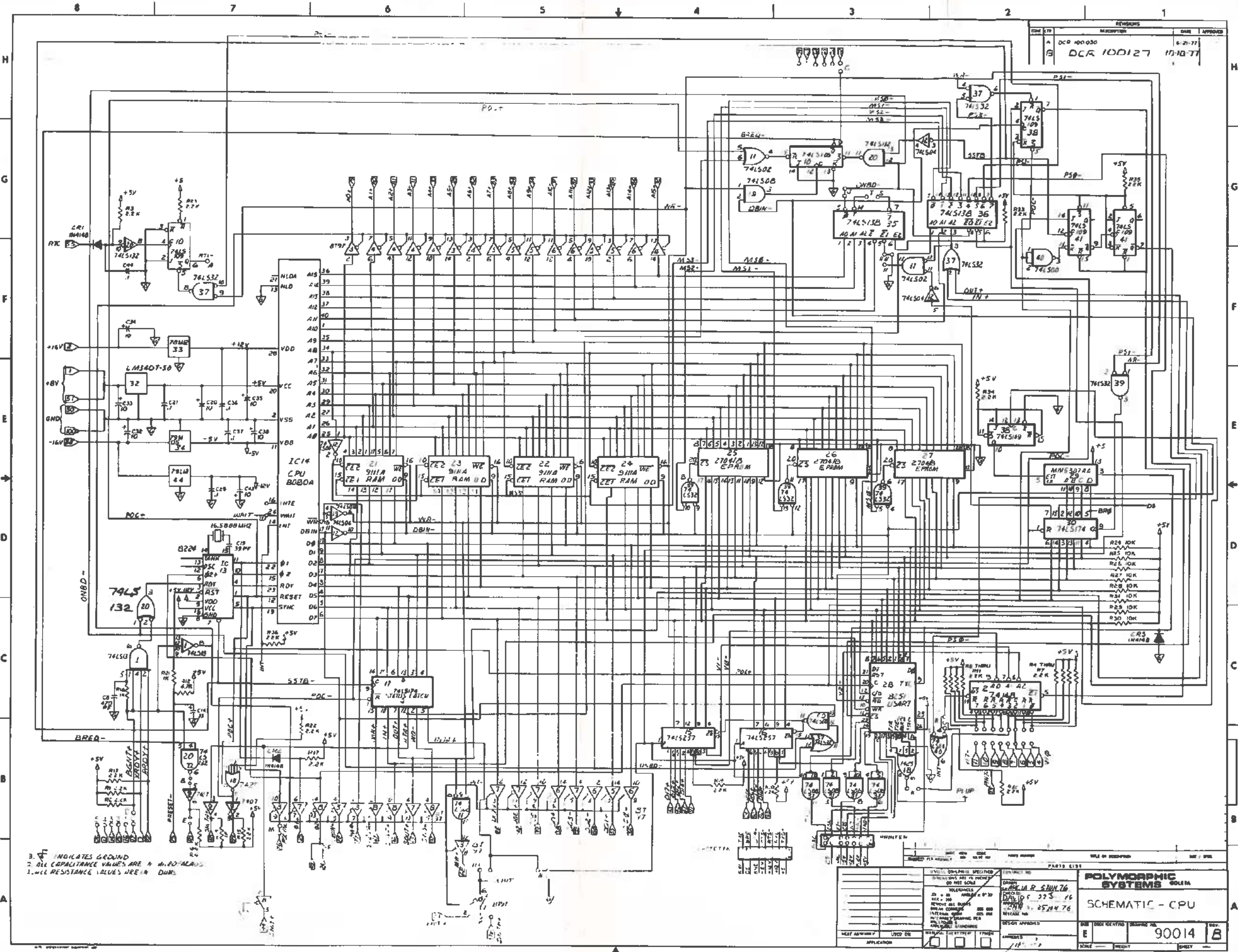

3.  $\nabla$  INDICATES GROUND  
 2. ALL CAPACITANCE VALUES ARE IN MICROFARADS  
 1. ALL RESISTANCE VALUES ARE IN OHMS

POLYMORPHIC SYSTEMS		SCHEMATIC - CPU	
DATE	10-10-77	REV	B
DESCRIPTION	DCR 100127	DESIGN APPROVED	
DESIGNED BY		DATE	
CHECKED BY		APPROVED	
DATE		SCALE	
APPREVED		SCALE	





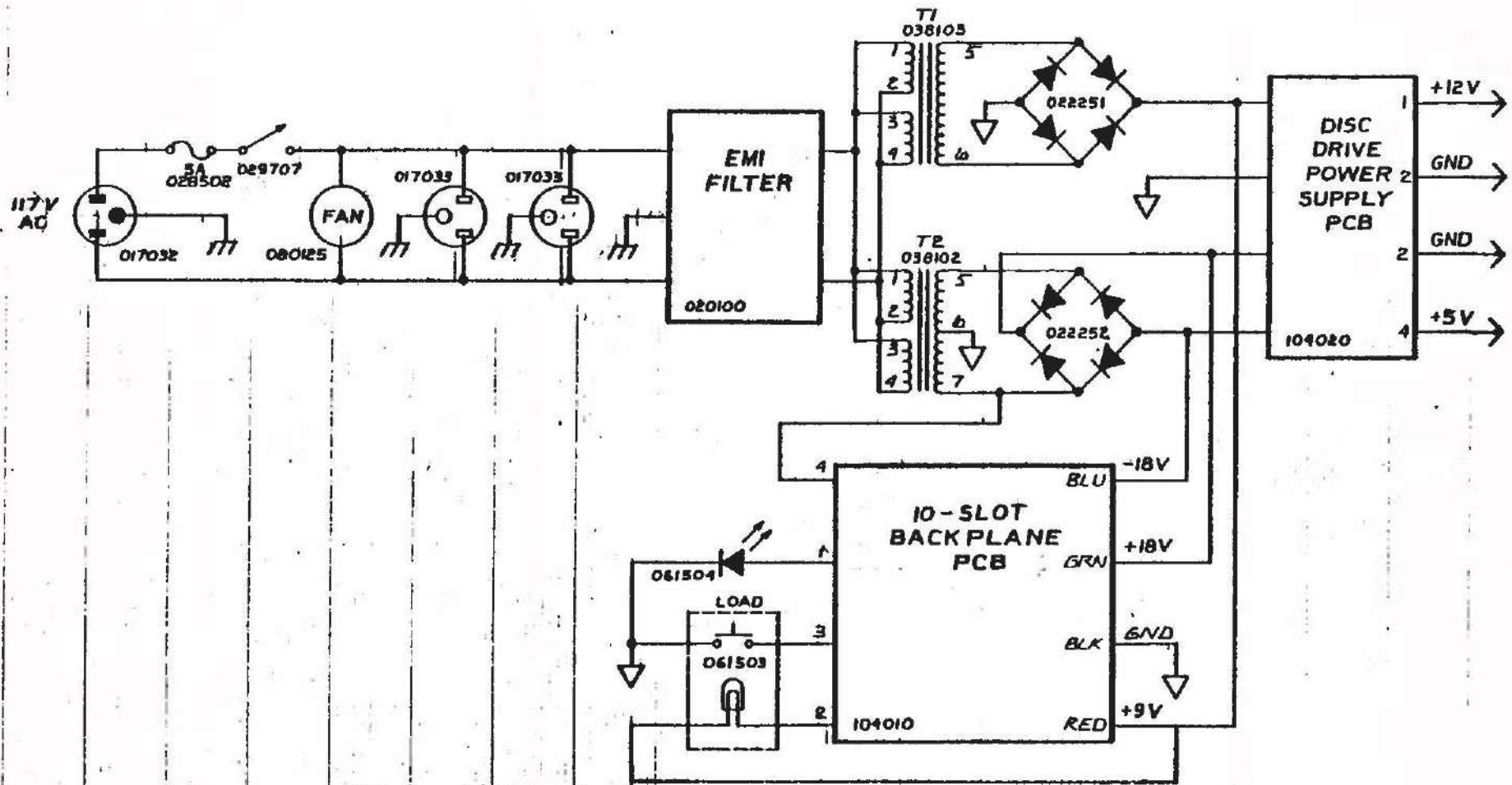

© 1977 INTERACTIVE PRODUCTS CORPORATION

<p>UNLESS OTHERWISE SPECIFIED:                  DIMENSIONS ARE IN INCHES AND DECIMALS THEREOF UNLESS OTHERWISE SPECIFIED.                  DIMENSIONS ARE IN MILLIMETERS AND DECIMALS THEREOF UNLESS OTHERWISE SPECIFIED.                  BREAK SHARP EDGES</p>	DWG. ARAKI, L. CHECK	DATE 6-22-77	POLYMORPHIC SYSTEMS GOLETA	
	APPR. J.H.A. USED ON	DATE 7-6-77		
	MATERIAL	NEXT ASSY	USED ON	SIZE C
	FINISH	THIS DOCUMENT CONTAINS PROPRIETARY INFORMATION. IT MAY NOT BE REPRODUCED OR TRANSMITTED IN ANY FORM OR BY ANY MEANS, ELECTRONIC OR MECHANICAL, INCLUDING PHOTOCOPYING, RECORDING, OR BY ANY INFORMATION STORAGE AND RETRIEVAL SYSTEM, WITHOUT THE WRITTEN PERMISSION OF INTERACTIVE PRODUCTS CORPORATION.		DRAWING NUMBER 10440E

NOTES: UNLESS OTHERWISE SPECIFIED



009011

REV	DESCRIPTION	DATE	APP
1	RELEASED DEC 100061	8/77	
A	DEC 100061	8/77	
B	DEC 100117	10/77	

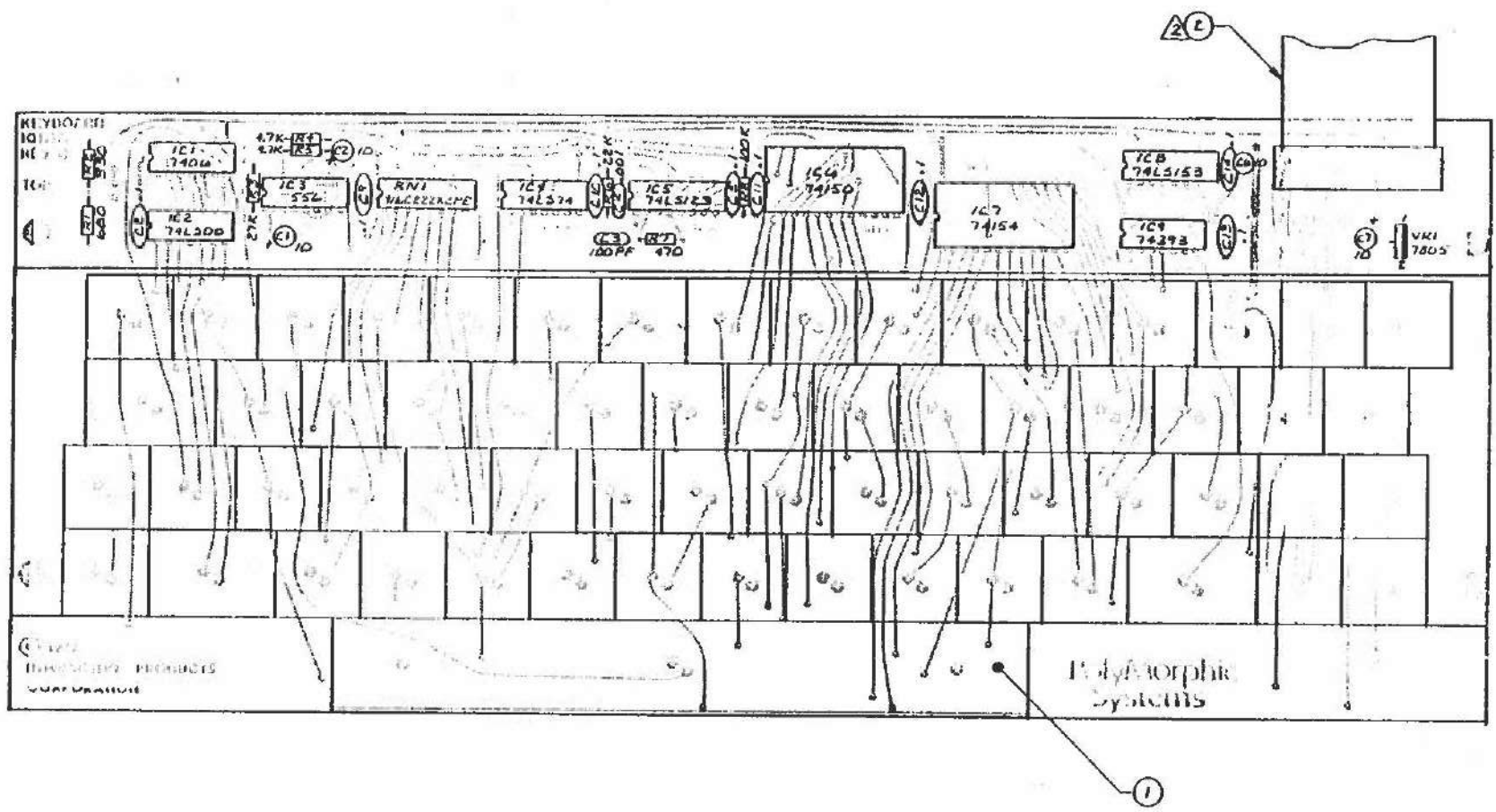

△ TO BE INSTALLED AFTER  
FLAME SOLDER OPERATION.  
1. SOCKET NOT REQUIRED FOR RNI

NOTES: UNLESS OTHERWISE SPECIFIED

1577 INTERACTIVE PRODUCTS CORPORATION  
SEE PARTS LIST D070H

THIS IS A UTILITY SPECIFIC INTERACTIVE BOARD FOR THE COMPANY'S USE IN TESTING AND APPS. AFTER PLACING SERIAL BOARD NUMBER	DATE 7/22/77 BY J.H.A. 7-2777	POLYMORPHIC SYSTEMS ASSY-KEYBOARD IC
SIZE D	DRAWING NUMBER 009011	REV B
SCALE 1/1	SHEET OF	1





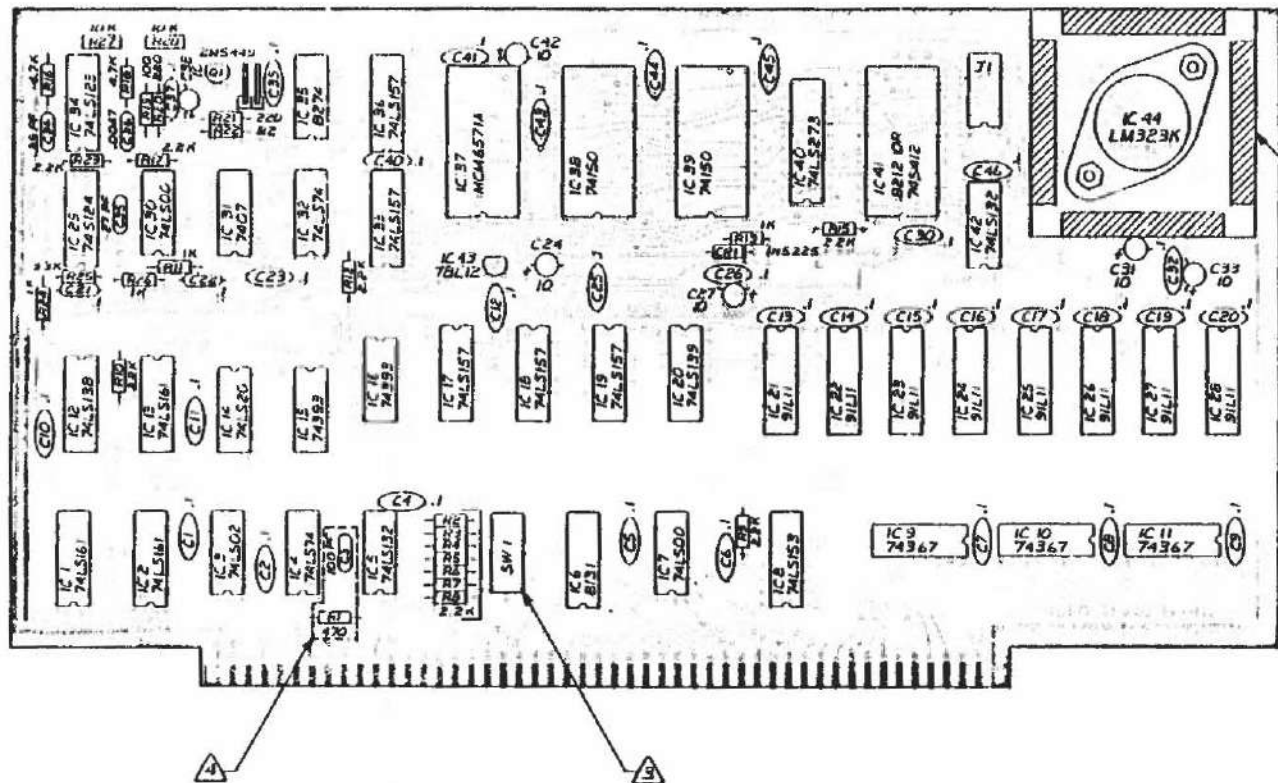

- 4 OMIT R1 AND C3 FOR USE WITH DISK SYSTEM.
- 3 TO BE INSTALLED AFTER FLOW SOLDER OPERATION.
- 2. MODIFY PER DRAWING 105255.
- 1. TO BE USED ON BOARDS UP TO REV 1.2

NOTES: UNLESS OTHERWISE SPECIFIED

POLY MORPHIC SYSTEMS		ASSY - VIDEO BOARD, 1.2	
DRAWING NUMBER 001026		REV B	
SCALE 2:1		SHEET 2 OF 2	

DESIGNER L. ARAKI	DATE 8-3-77
CHECKED J. H. H.	REVISED 8-8-77
MATERIAL	
FURNISH	

004040 8

REV	DESCRIPTION	DATE	APP
A	DCR 100057	4-77	JH
B	DCR 100034 100113 100180	9-27-78	JH

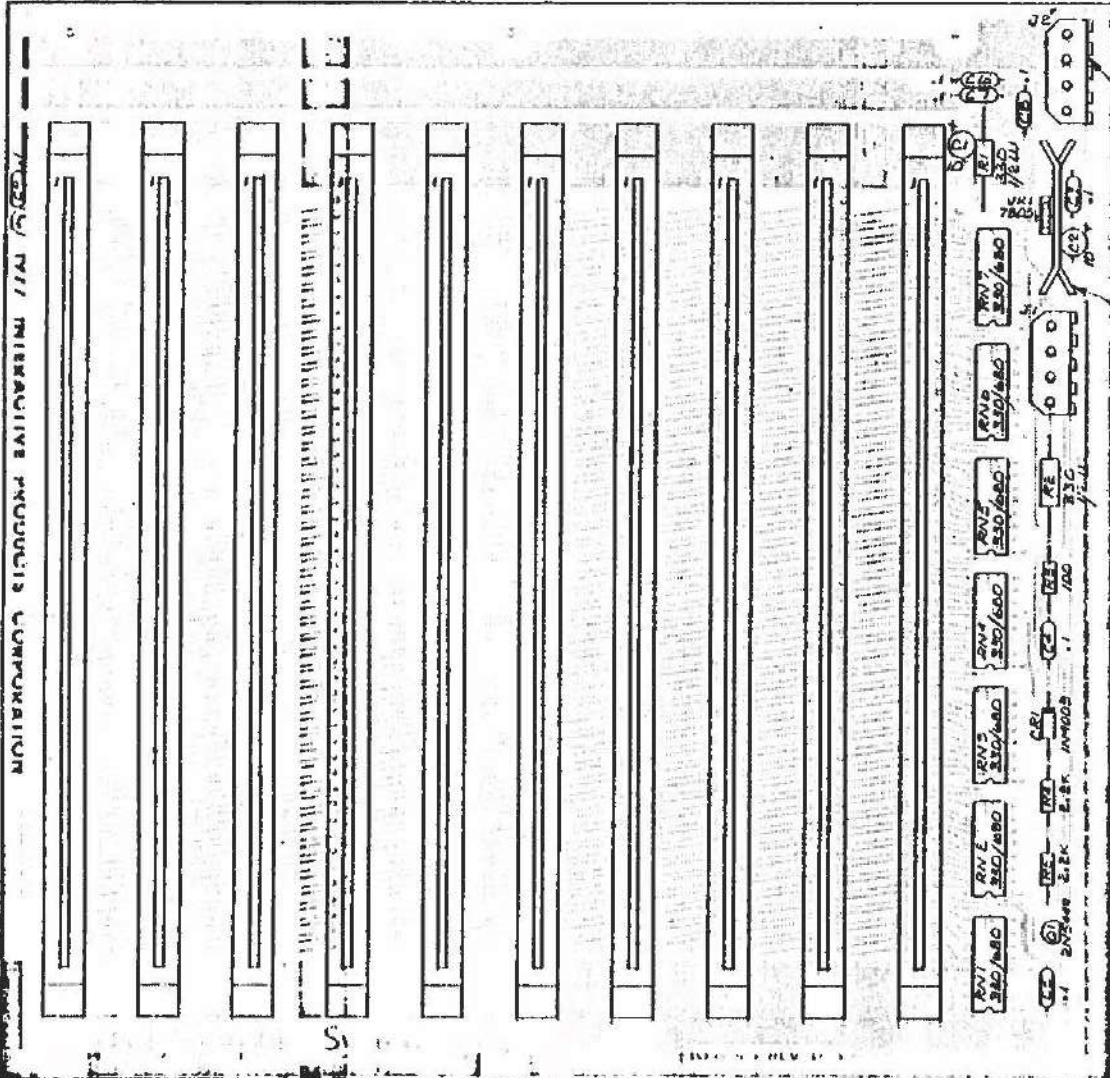

(10) 2 REQD

(8) (9) (13) (14) (15) (A)

POLY MORPHIC SYSTEMS CORPORATION

SEE PARTS LIST 004040

- TO BE INSTALLED AFTER FLOW SOLDER OPERATION.
- MODIFY PER 104493.
- RESISTOR NETWORKS (RNI THROUGH) TO BE INSTALLED AFTER BACKPLANE TEST.
- NOTES: UNLESS OTHERWISE SPECIFIED

UNLESS OTHERWISE SPECIFIED, ALL DIMENSIONS ARE IN INCHES AND DECIMALS THEREOF UNLESS OTHERWISE SPECIFIED.		DATE: 6-17-77 BY: R. S. S. / FEA CHECKED: FEA / VAD		POLYMORPHIC SYSTEMS	
JOB NO. 100000 DRAWING NO. 004040 SHEET NO. 8		DATE: 6-30-77 BY: FEA / VAD		ASSY - SYS BB13 BACKPLANE	
TITLE: 004040 SIZE: D DRAWING NUMBER: 004040 REV: B		SCALE: 1:1 SHEET: 8			







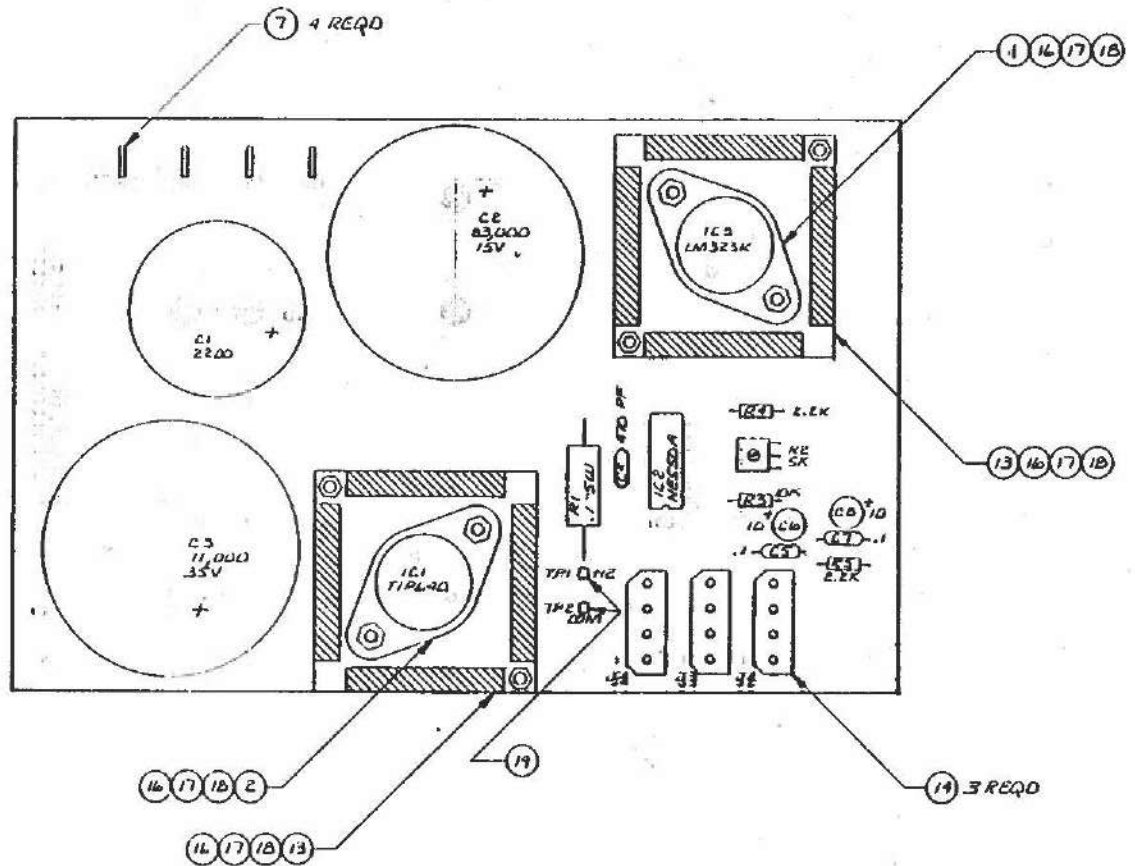

NOTES: UNLESS OTHERWISE SPECIFIED

1977 INTERACTIVE PRODUCTS CORPORATION  
SEE PARTS LIST 004020

THIS IS A PAPER BACK DRAWING AND IS NOT TO BE USED FOR MANUFACTURING UNLESS OTHERWISE SPECIFIED IN THE DRAWING AND APPLICABLE TO THE DRAWING.		DATE: 11/22/77 BY: R. S. S. / E.F.A. CHECKED: E.F.A. APPROVED: J.P.A.	POLYMERPHIC SYSTEMS ASSY-SYS 8813 POWER SUPPLY
SIZE: D SCALE: 2/1	DRAWING NUMBER: 004020	SHEET OF: 1	REV:

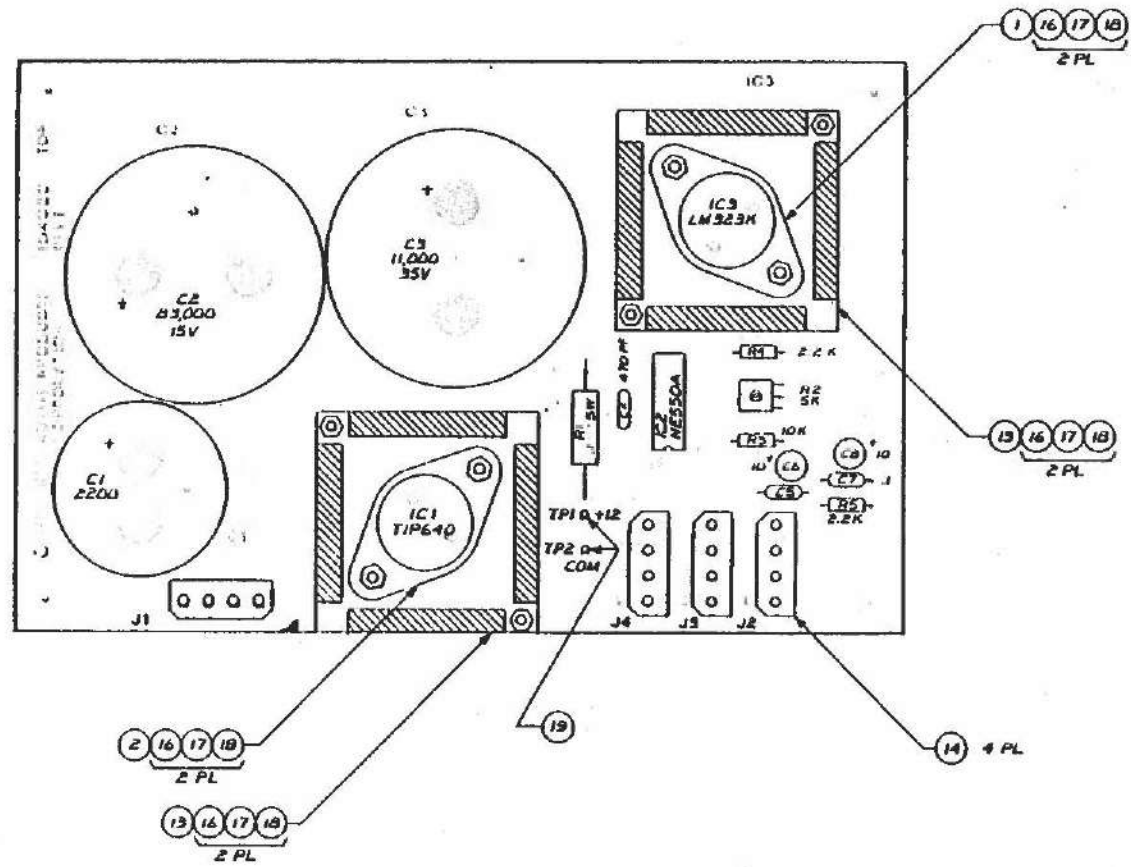

NOTES: UNLESS OTHERWISE SPECIFIED

POLY MORPHIC SYSTEMS		POLY MORPHIC SYSTEMS	
ASSY - SYS 8813 POWER SUPPLY		ASSY - SYS 8813 POWER SUPPLY	
DESIGNER	L. ARAKI	DATE	11-8-77
APP'D	V. H. A.	REV	A
DRAWING NUMBER	004020	REV	A
SHEET	1	SHEET	1

001027  
DRAWING NO.

REV.

REVISIONS			
REV.	DESCRIPTION	DATE	APPR

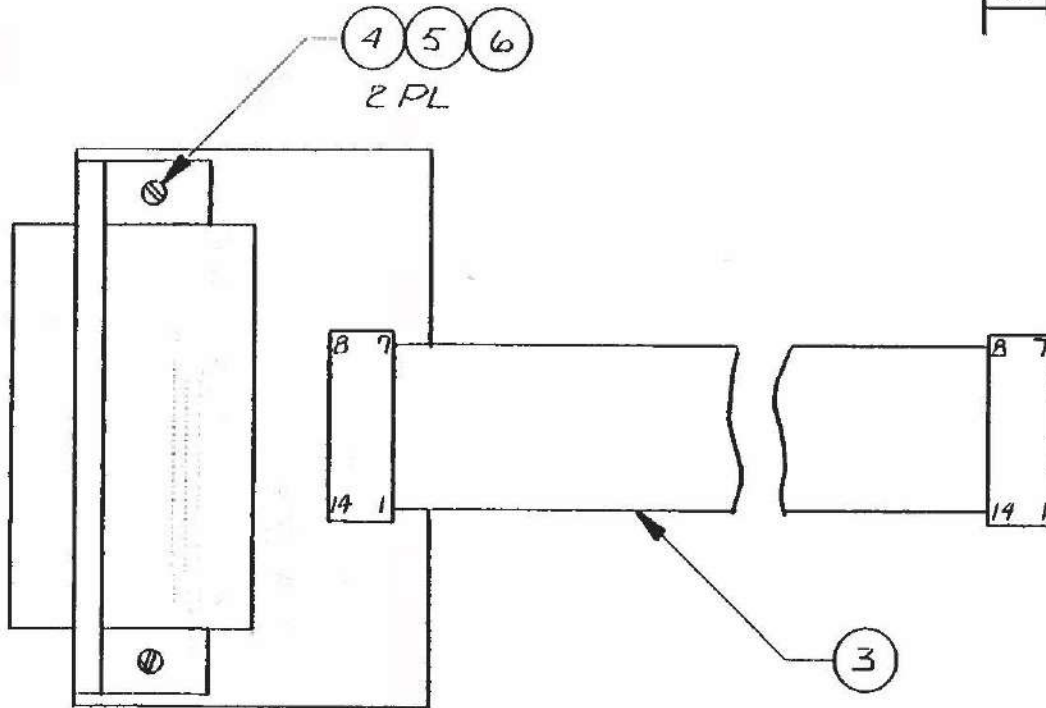

SEE PARTS LIST 001027

UNLESS OTHERWISE SPECIFIED INTERPRET DRAWING PER ANSI Y14 DIMENSIONS ARE IN INCHES AND APPLY AFTER PLATING BREAK SHARP EDGES	DWGR <i>R. Sanchez</i>	DATE 6-17-77	POLYMORPHIC SYSTEMS					
	CHECK F.E.A.	6-30-77						
<table border="1"> <tr> <td><del>XX ±</del></td> <td>X* ±</td> </tr> <tr> <td>XXX ±</td> <td>J</td> </tr> </table>	<del>XX ±</del>	X* ±	XXX ±	J	PROJ. ENG. F.E.A.	6-30-77	ASSY-PARALLEL BD	
<del>XX ±</del>	X* ±							
XXX ±	J							
	APPR <i>J.R.A.</i>	7-5-77						
MATERIAL	NEXT ASSY		USED ON					
FINISH	THIS DOCUMENT CONTAINS PROPRIETARY INFORMATION. IT MAY NOT BE REPRODUCED OR TRANSMITTED TO OTHER DOCUMENTS OR DISCLOSED TO OTHERS OR USED FOR MANU- FACTURING OR ANY OTHER PURPOSE WITHOUT PRIOR WRITTEN PERMISSION.		SIZE <b>B</b>	DRAWING NUMBER 001027	REV			
NOTES: UNLESS OTHERWISE SPECIFIED	SCALE 2/1		1577 BKT-041027 2250 1-1-10 001027	SHEET	OF			

REV	DESCRIP	DATE	APPR
A	DCR 100115 10U120	10-19-77	[Signature]

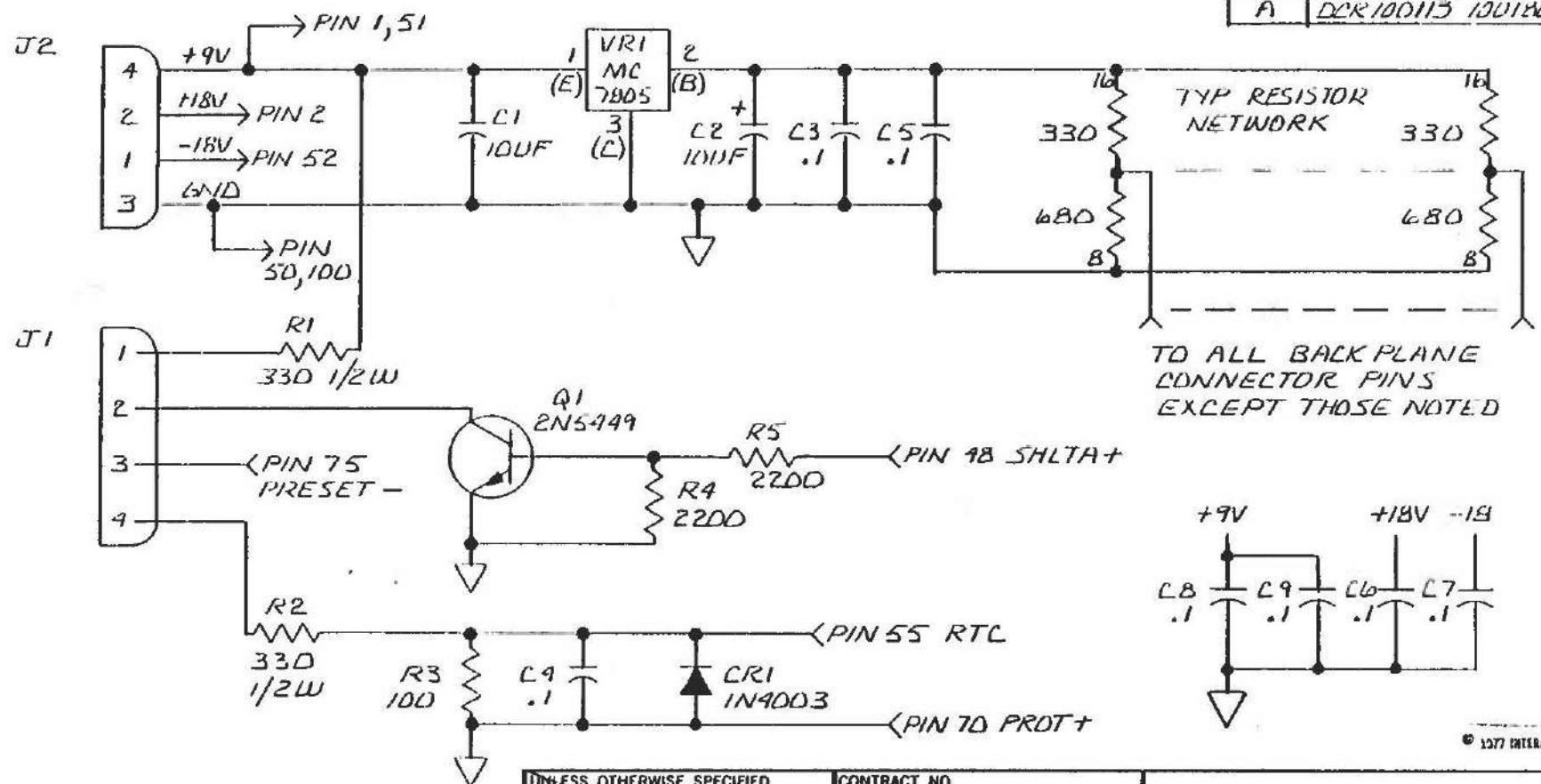

© 1977 INTERACTIVE PRODUCTS CORPORATION

UNLESS OTHERWISE SPECIFIED DIMENSIONS ARE IN INCHES TOLERANCES ARE:		
FRACTIONS	DECIMALS	ANGLES
±	.XX ±	±
	.XXX ±	
MATERIAL		
FINISH		
DO NOT SCALE DRAWING		

CONTRACT NO.	
APPROVALS	DATE
DRAWN <i>R. Sanchez</i>	3-15-77
CHECKED	
APPR. <i>JAA</i>	10/6

POLYMORPHIC SYSTEMS			
SCHEMATIC - 10 SLOT BACKPLANE			
SIZE	CODE IDENT NO.	DRAWING NO.	REV
B		104041	A
SCALE			SHEET OF



REV	DISC/P	DATE	APP
A	DCR 10015B	8-3-77	

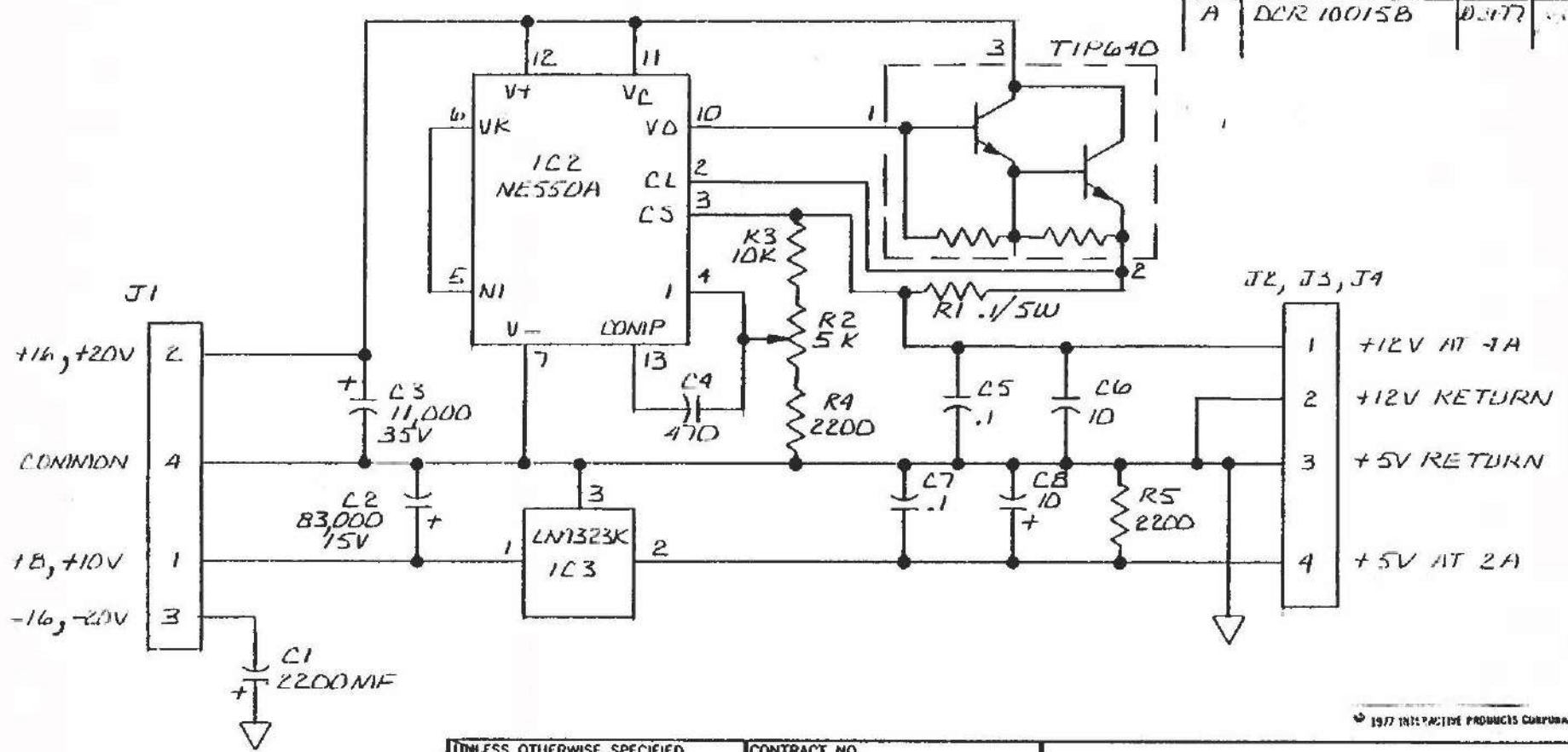

© 1977 INTELLECTIVE PRODUCTS CORPORATION

UNLESS OTHERWISE SPECIFIED DIMENSIONS ARE IN INCHES TOLERANCES ARE: FRACTIONS    DECIMALS    ANGLES .                XX ±                ° MATERIAL  FINISH  DO NOT SCALE DRAWING	CONTRACT NO.		POLYMORPHIC SYSTEMS			
	APPROVALS				DATE	
	DRAWN <i>R. Sanchez</i>		4-5-77	SCHEM-FLOPPY POWER SUPPLY		
	CHECKED					
APPR. <i>J.P.A.</i>		10/16	SIZE	CODE IDENT NO.	DRAWING NO.	REV
			B		104021	A
			SCALE	SHEET		OF

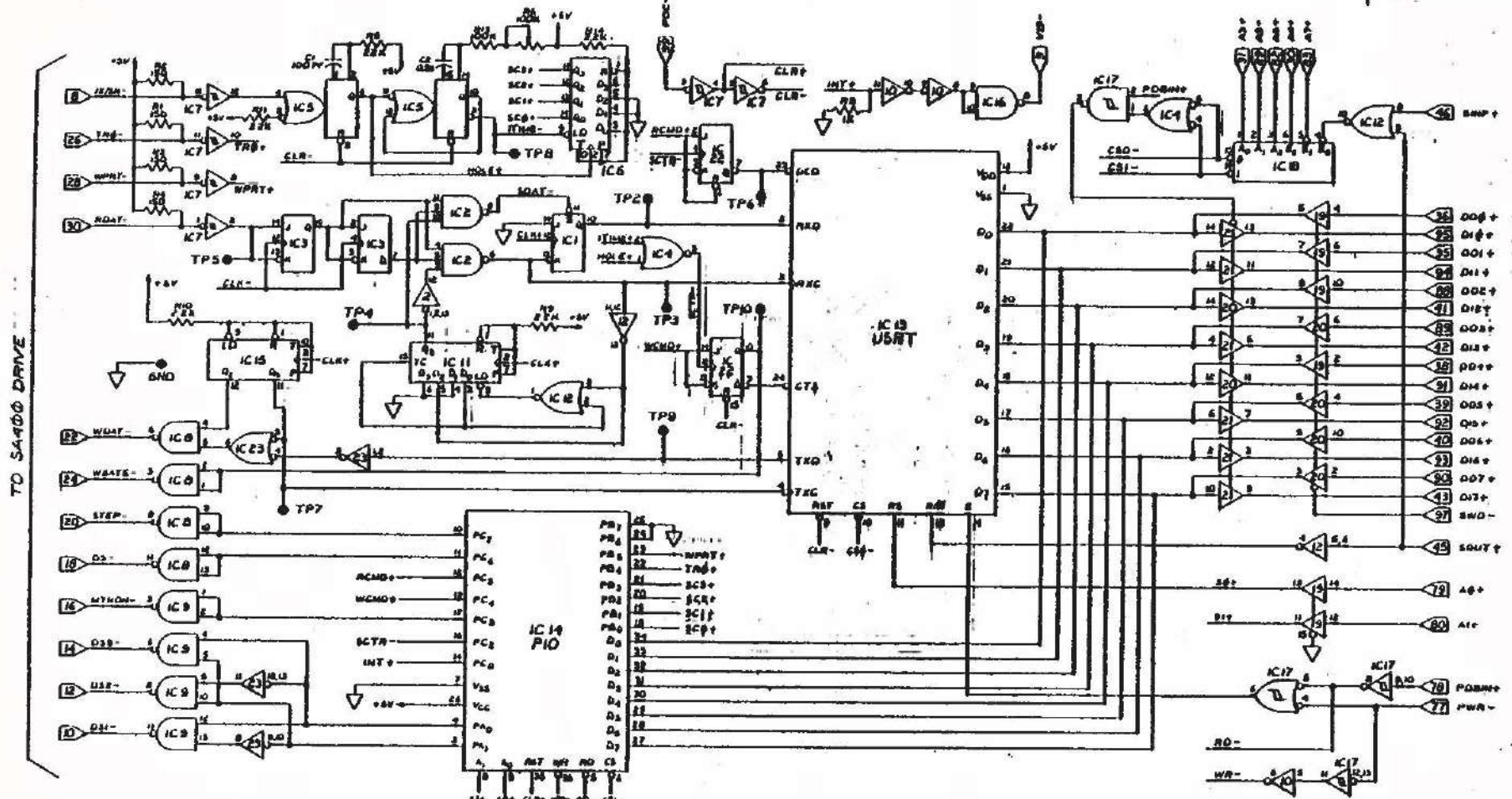

TO SAT00 DRIVE

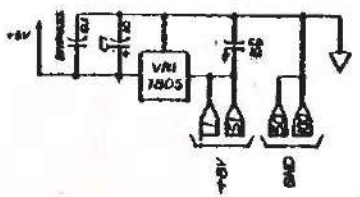
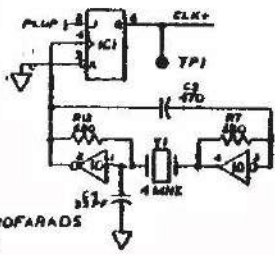

2. ALL CAPACITANCE VALUES ARE IN MICROFARADS  
 1. ALL RESISTANCE VALUES ARE IN OHMS

NOTES: UNLESS OTHERWISE SPECIFIED

IC 1	74LS00	IC 9	74LS00	IC 17	74LS14
IC 2	74LS00	IC 10	74LS00	IC 18	74LS04
IC 3	74LS00	IC 11	74LS10		
IC 4	74LS00	IC 12	74LS04		
IC 5	74LS00	IC 13	74LS123		
IC 6	74LS00	IC 14	74LS14		
IC 7	74LS00	IC 15	74LS14		
IC 8	74LS00	IC 16	74LS14		
IC 9	74LS00	IC 17	74LS14		
IC 10	74LS00	IC 18	74LS04		
IC 11	74LS10				
IC 12	74LS04				
IC 13	74LS123				
IC 14	74LS14				
IC 15	74LS14				
IC 16	74LS14				
IC 17	74LS14				
IC 18	74LS04				

© 1977 INTERACTIVE PRODUCTS CORPORATION

ARAKI 5-20-77

POLYMORPHIC SYSTEMS

SCHEMATIC - DISC CONTROLLER

DATE: 10/77

SCALE: 1:1

DRAWING NUMBER: 10-1011

REV: D

DESIGNER: J.P.L.

CHECKED: J.P.L.

APPROVED: J.P.L.

REV	DESCRIPTION	DATE	APP
-	RELEASED DCR 10004E	7-1872	
A	DCR 100134	10-17-72	PL
B	DCR 100160	11-17-72	PL

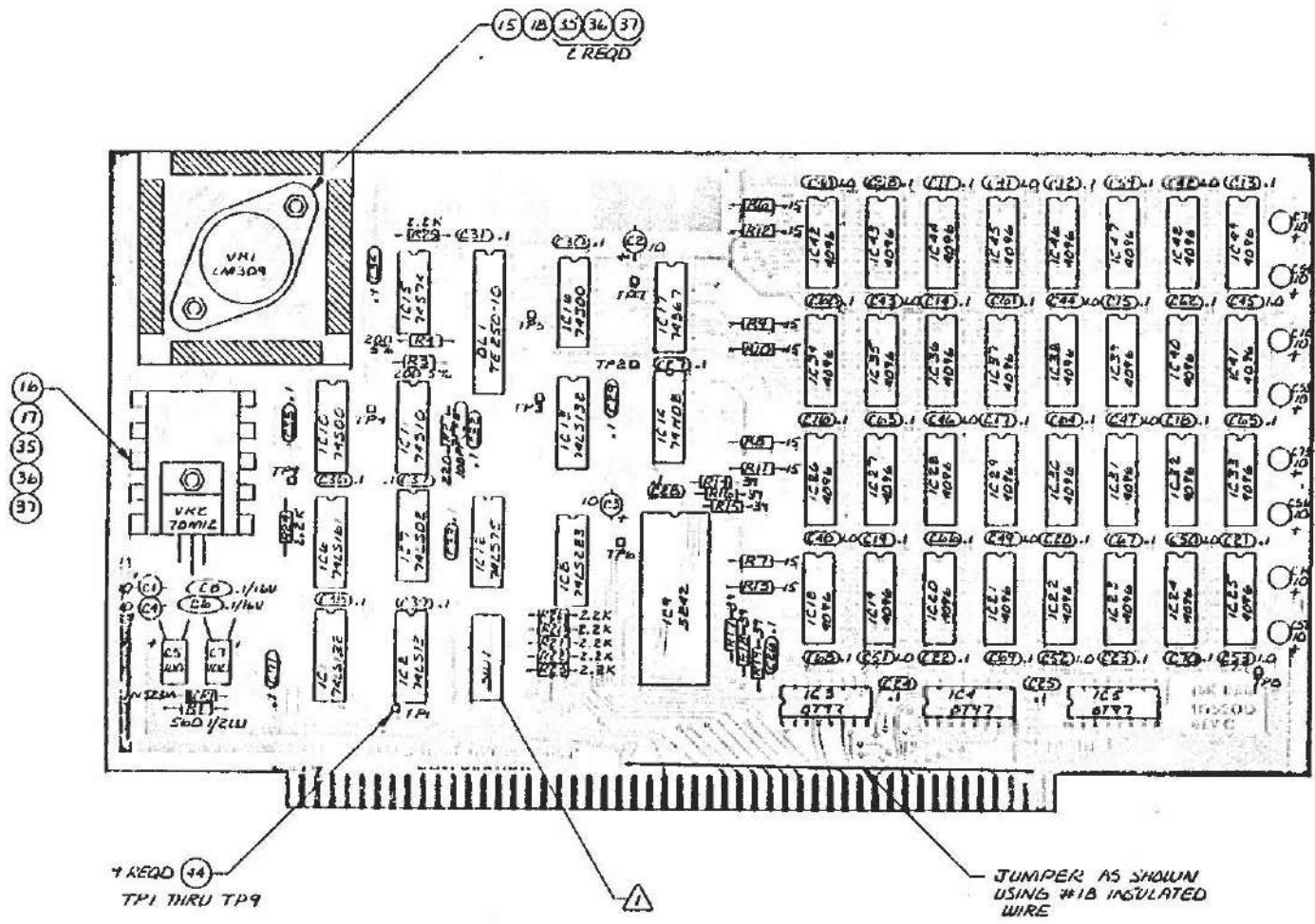

2. MODIFY PER DWG 109990.

⚠ TO BE INSTALLED AFTER FLOW SOLDER OPERATION.

NOTES: UNLESS OTHERWISE SPECIFIED

PARTS LIST PART NO. QTY. UOM. PART NAME 1 1 1 VME 70912 2 1 1 VME 70909 3 1 1 VME 70910 4 1 1 VME 70911 5 1 1 VME 70912 6 1 1 VME 70913 7 1 1 VME 70914 8 1 1 VME 70915 9 1 1 VME 70916 10 1 1 VME 70917 11 1 1 VME 70918 12 1 1 VME 70919 13 1 1 VME 70920 14 1 1 VME 70921 15 1 1 VME 70922 16 1 1 VME 70923 17 1 1 VME 70924 18 1 1 VME 70925 19 1 1 VME 70926 20 1 1 VME 70927 21 1 1 VME 70928 22 1 1 VME 70929 23 1 1 VME 70930 24 1 1 VME 70931 25 1 1 VME 70932 26 1 1 VME 70933 27 1 1 VME 70934 28 1 1 VME 70935 29 1 1 VME 70936 30 1 1 VME 70937 31 1 1 VME 70938 32 1 1 VME 70939 33 1 1 VME 70940 34 1 1 VME 70941 35 1 1 VME 70942 36 1 1 VME 70943 37 1 1 VME 70944 38 1 1 VME 70945 39 1 1 VME 70946 40 1 1 VME 70947 41 1 1 VME 70948 42 1 1 VME 70949 43 1 1 VME 70950 44 1 1 VME 70951 45 1 1 VME 70952 46 1 1 VME 70953 47 1 1 VME 70954 48 1 1 VME 70955 49 1 1 VME 70956 50 1 1 VME 70957 51 1 1 VME 70958 52 1 1 VME 70959 53 1 1 VME 70960 54 1 1 VME 70961 55 1 1 VME 70962 56 1 1 VME 70963 57 1 1 VME 70964 58 1 1 VME 70965 59 1 1 VME 70966 60 1 1 VME 70967 61 1 1 VME 70968 62 1 1 VME 70969 63 1 1 VME 70970 64 1 1 VME 70971 65 1 1 VME 70972 66 1 1 VME 70973 67 1 1 VME 70974 68 1 1 VME 70975 69 1 1 VME 70976 70 1 1 VME 70977 71 1 1 VME 70978 72 1 1 VME 70979 73 1 1 VME 70980 74 1 1 VME 70981 75 1 1 VME 70982 76 1 1 VME 70983 77 1 1 VME 70984 78 1 1 VME 70985 79 1 1 VME 70986 80 1 1 VME 70987 81 1 1 VME 70988 82 1 1 VME 70989 83 1 1 VME 70990 84 1 1 VME 70991 85 1 1 VME 70992 86 1 1 VME 70993 87 1 1 VME 70994 88 1 1 VME 70995 89 1 1 VME 70996 90 1 1 VME 70997 91 1 1 VME 70998 92 1 1 VME 70999 93 1 1 VME 71000	DATE: 7/18/72 DRAWN BY: [Signature] CHECKED BY: [Signature] APPROVED BY: [Signature]	POLYDORPHIC SYSTEMS ASSY-16K RAM	SIZE: D DRAWING NUMBER: 005200 SHEET OF: B
---	---	-------------------------------------	--



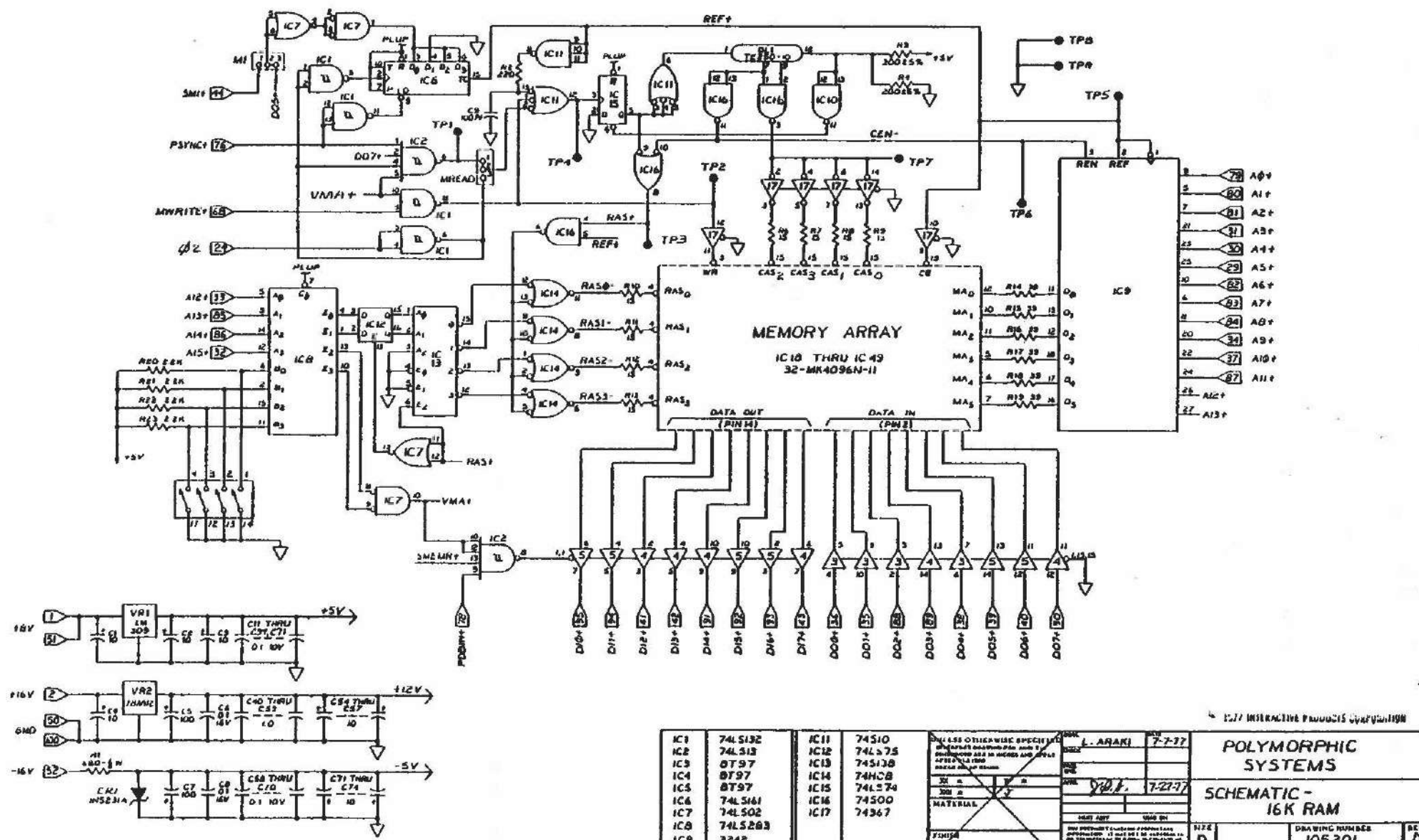

IC1	74LS132	IC11	74LS10	SEE LIST OTHER WIRE SPECIFICATIONS ALL PARTS SHOWN ARE TO BE USED UNLESS OTHERWISE SPECIFIED IN NOTES AND DRAWING. ALL PARTS TO BE USED UNLESS OTHERWISE SPECIFIED IN NOTES AND DRAWING. ALL PARTS TO BE USED UNLESS OTHERWISE SPECIFIED IN NOTES AND DRAWING.	L. ARAKI 7-7-77 7-21-77	POLYMORPHIC SYSTEMS SCHEMATIC - 16K RAM
IC2	74LS13	IC12	74LS75			
IC3	0T97	IC13	74LS138			
IC4	0T97	IC14	74HC8			
IC5	0T97	IC15	74LS74			
IC6	74LS161	IC16	74S00			
IC7	74LS02	IC17	74367			
IC8	74LS263					
IC9	3242					
IC10	74S00					

1277 INTERACTIVE PRODUCTS CORPORATION

DWG NO. 105201  
 SHEET 01



001062  
REV. B

REVISIONS			
NO.	DESCRIPTION	DATE	BY
A	DCR 100115	7/77	
B	DCR 100113	6/77	

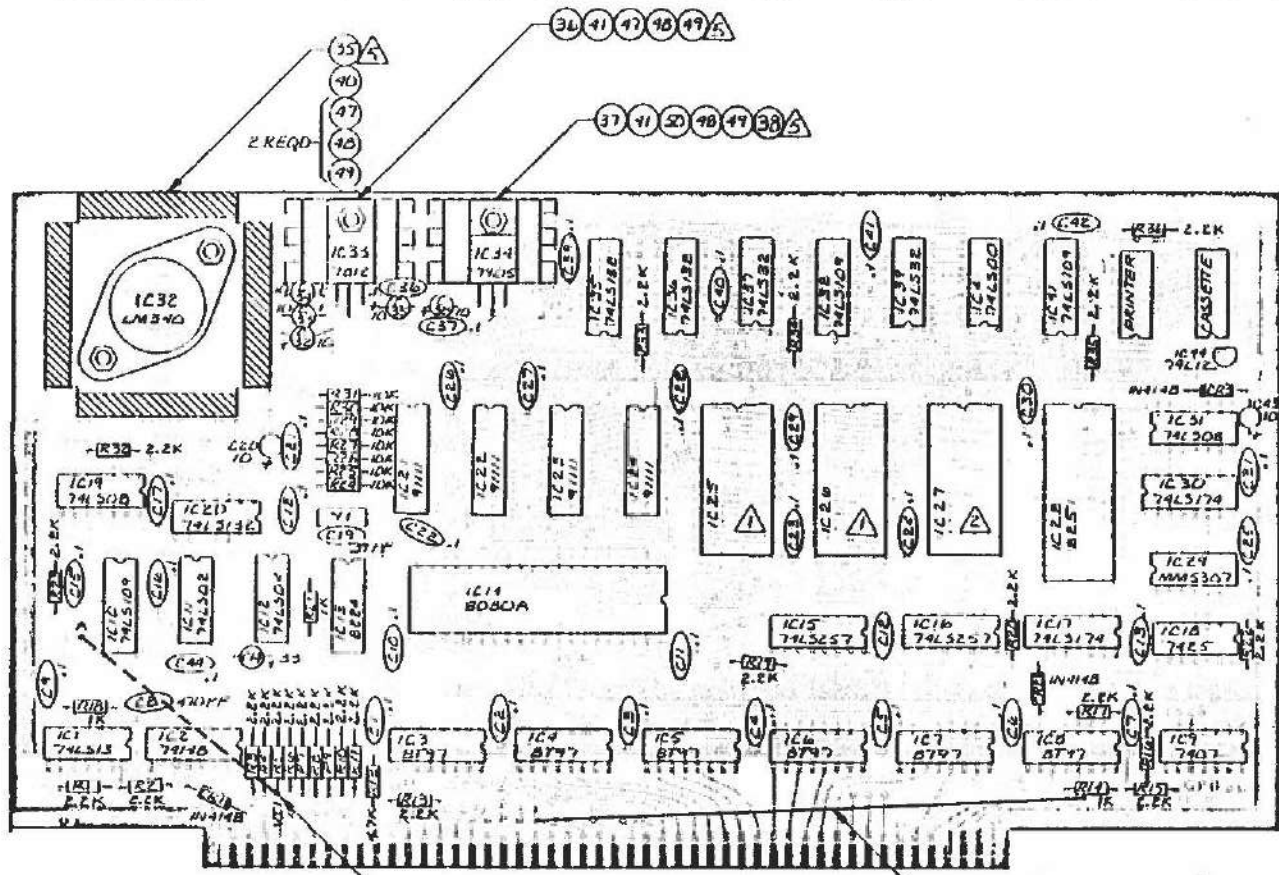

1. TO BE INSTALLED AFTER FLOTT SOLDER OPERATION
2. MODIFY PER DUAL 104426, 104433, 105252.
3. TO BE USED FOR BOARDS UP TO REV. D.34

△ IC27: A.O MONITOR P/N 035020.

△ FOR DISC SYSTEMS:  
 A. IC25 ROOT ROM 400 P/N 035025  
 B. IC26 ROOT ROM 800 P/N 035030

NOTES: UNLESS OTHERWISE SPECIFIED

JUMPER 'VI' TO 'A' FAR SIDE

JUMPER 'F' TO 'F'

© 1977 INTELLIGENT PRODUCTS CORPORATION

UNIT AND OTHERWISE SPECIFIED IN THIS DRAWING PER AND THE PARTS AND ASSEMBLY AFTER THE BOARD SHALL BE ASSEMBLED	DATE 12/77 BY J.P.A. 1377	POLY MORPHIC SYSTEMS 1355Y-CPLI BOARD
PARTIAL	UNIT NO.	SIZE D
DRAWING NUMBER 001062	SHEET OF 1	SCALE 1:1