

HARD DISK MICRO DECISION

Models MD5, MD11, MD16, & MD34

MORROW



```

*****
*
*   NOTICE!  TWO "HARD DISK RULES OF THE ROAD" THAT
*   YOU SHOULD BE AWARE OF IMMEDIATELY ARE:
*
*
*   1.  PARK THE HARD DISK BEFORE TURNING OFF
*       THE MICRO DECISION  (page 2-12)
*
*   2.  BACK UP YOUR HARD DISK FILES ONTO
*       FLOPPY DISKS REGULARLY  (page 2-10)
*
*****

```

-- (*) --

Consider this booklet your tour guide. It is written for people like yourself who have chosen one of Morrow's Hard Disk Micro Decision computer systems. It is meant to get you started with the Micro Decision, and to show you some good maintenance habits. Be aware that it **doesn't** teach you how to use your software (NewWord, Personal Pearl, etc.), since these are covered in their own manuals.

We want to get you hooked up and running right away. So, if you're a complete newcomer to Computersville, you may want to skim Chapter 6 for a few fundamentals like how to handle diskettes. Chapter 6 also lists the Micro Decision's general specifications.

Copyright (c) 1985 by Morrow Designs, Inc.

World Rights Reserved.

No part of this publication may be reproduced, transmitted, stored in a retrieval system, or translated into any language or computer language, in any form or by any means, electronic, mechanical, magnetic, optical, chemical, manual or otherwise, without prior written permission of Morrow Designs Inc.

DISCLAIMER

No representations or warranties, express or implied, are made with respect to the contents hereof, including but not limited to the implied warranty of merchantability or fitness for a particular purpose. Further, Morrow Designs Inc. reserves the right to revise this publication and to make changes from time to time in the content hereof without obligation to notify anyone of such revision.

NewWord is a product of NewStar Software, Inc.

SuperCalc is a registered trademark of Sorcim Corp.

MBASIC-80 is a product of Microsoft, Inc.

Personal Pearl is a product of PearlSoft, Inc.

Quest is a trademark of Quest, Inc.

Micro Decision, Correct-It, PILOT, and the Co-Pilot Menus are products of Morrow, Inc.

CP/M 3.0 is a product of Digital Research.

HARD DISK MICRO DECISION USER'S GUIDE

CONTENTS

This manual pertains to all hard disk
Micro Decision models, including
MD-5, MD-11, MD-16, and MD-34.

CHAPTER 1. WIRING IT UP AND FIRING IT UP

Materials Checklist	1-1
Terminals That Work Well With the MD.	1-2
Printers That Will Prove Convenient to Use.	1-3
Unpacking	1-4
Setting Things in Place	1-5
Connecting the Terminal	1-6
Connecting the Keyboard	1-7
Connecting the Printer.	1-7
Parallel Printers.	1-8
Serial Printers.	1-9
Unfortunately You're Not Quite Finished	1-9
Terminal Setup	1-9
Checkpoint A.	1-11
The Next Steps.	1-11
Fire That Baby Up	1-12
Checkpoint B.	1-13
Checkpoint C.	1-14
If You Didn't Make it to Checkpoint C.	1-16
Setting Up Serial Printers.	1-17

CHAPTER 2. USING YOUR MICRO DECISION FOR THE FIRST TIME

The Main Menu, Revisited.	2-2
A Sampling of the Software.	2-3
NewWord.	2-3
SuperCalc.	2-6
Correct-It	2-7
Personal Pearl	2-8
Quest.	2-9
The Backfield.	2-10
Microsoft BASIC.	2-12
PARK	2-12
ESC: Exit to CP/M.	2-13

CHAPTER 2 continued

The Utility Menu: Your Tool Box	2-14
Display a Directory.	2-14
View or Print a File	2-15
Copy a File or Files	2-17
Format a Diskette.	2-18
Check Space and File Size.	2-19
Execute a CP/M Command	2-20
Rename or Erase a File	2-22
Fundamental Training in CP/M	2-23
Load Quest Bookkeeper.	2-23
Installing Quest	2-24
Improvements in Bookkeeper II.	2-25
Upgrading from Bookkeeper I to II.	2-25
Whew!	2-26

CHAPTER 3. ABOUT THE PROGRAMS IN USER 0

PARK.COM.	3-3
FORMAT.COM.	3-3
KEY.COM	3-4
SETUP.COM	3-4
PILOT.COM	3-5
PROFILE.SUB	3-6
BACKUP.COM.	3-7
CPM2.COM, CPM3.COM and CPM2.RSX	3-8
FOREIGN.COM	3-9
IMS.COM	3-10
INIT.COM.	3-10
COPYSYS.COM, SYSLDR.COM, and CPM3.SYS	3-11
HDL.COM, HDBOOT.COM, and HDPIP.COM.	3-13
BNKBIOS3.MAC and BIOS.SUB	3-14
VERIFILE.COM.	3-14

CHAPTER 4. MICRO DECISION QUESTIONS AND ANSWERS

<u>General</u>	
When to Press RESET, and When Not To.	4-1
Restrictions on File Names.	4-2
Disk Drive Letters.	4-3
Booting From the Floppy (Rebuilding Hard Disk).	4-7
Changing Hardware After Installing the Software	4-11

CHAPTER 4 continued

Co-Pilot Menus

Adding Programs to the Menus	4-14
Disabling the Menus	4-14
Translating the Menus	4-15

CP/M

Learning About CP/M	4-18
Relationship Between CP/M and Other Software.	4-18
Booting Defined	4-18
Compatibility Among CP/M Computers.	4-20
Running Programs Straight From CP/M	4-21
Built-In vs. Transient Commands	4-24

NewWord and Printing

Modifying NewWord	4-25
Printing and Typing Simultaneously.	4-26
Printing What Appears Onscreen.	4-28

Non-Morrow Systems and Software

Adding Software to the Hard Disk.	4-29
Dealing with Foreign Diskettes.	4-31

CHAPTER 5. ERRORS AND OTHER NUISANCES

Operator Error Messages	5-1
Disk Error Messages	5-3
<u>Recoverable Errors</u>	
Drive Not Ready.	5-4
Write Protected.	5-4
Not Found.	5-5
Data Address CRC Error	5-5
ID Address CRC Error	5-5
Data Error	5-5
Equipment Failure.	5-5
Media Failure.	5-6
Seek Error	5-6
Unable to Remap.	5-6
Unknown Error Code	5-6
Error Message Responses	5-6
R - to Try Again	5-7
A - to Abort	5-7
I - to Ignore.	5-8
<u>Nonrecoverable Errors</u>	
Select Error	5-8
Disk Read Only	5-9
File Read Only	5-9
Summary	5-9

CHAPTER 6. ABOUT YOUR SYSTEM

The Absolute Essentials	6-1
Hardware & Software.	6-1
Types of Software.	6-2
Computer Hardware.	6-3
Disks and Disk Drives.	6-4
System Hardware Specifications.	6-4
System Software Specifications.	6-5
System Requirements	6-6
Optional Hardware	6-7
Printers	6-7
Modems	6-7
Additional Software	6-8
The Micro Decision's Disk Drives.	6-9
The Hard Disk.	6-9
How Floppies Fit Into the Picture.	6-11
Do's and Don'ts for Diskettes	6-12
Formatting Diskettes.	6-12
Write Protection.	6-13
Inserting Diskettes	6-14
Disk Drive Letters	6-15
Virtual Floppy Drives.	6-15
The Co-Pilot Menus.	6-16
About Your Keyboard	6-16
ESC Key.	6-17
CAPS LOCK Key.	6-17
SHIFT Key.	6-17
CTRL Key	6-18
BACK SPACE Key	6-18
DELETE Key	6-18
RETURN Key	6-18
NO SCROLL Key.	6-19
Numeric Keypad	6-19
Function Keys and Special Symbol Keys.	6-19
Cursor Keys.	6-20

Each Appendix has its own table of contents.

APPENDIX A. BACKFIELD USER'S GUIDE

APPENDIX B. PROGRAMMING MDT-60 / MT-70 FUNCTION KEYS (KEY.COM)

APPENDIX C. RUNNING CP/M 2.2 SOFTWARE ON THE MICRO DECISION

APPENDIX D. CONNECTING DEVICES TO THE MICRO DECISION

APPENDIX E. MOTHERBOARD JUMPER OPTIONS

APPENDIX F. GLOSSARY

CHAPTER 1

----- WIRING IT UP AND FIRING IT UP

By the end of this chapter, you will be through all the rigamarole of unpacking, connecting cables, testing the hardware, and installing the software. This should take less than an hour.

MATERIALS CHECKLIST

To make sure you have everything you're supposed to, check your pile of manuals, diskettes and hardware against this list. If anything's missing, contact your dealer.

Hardware

- o Micro Decision computer (the unit with the disk drives) with power cord & four rubber stick-on feet
- o Terminal (Display screen plus keyboard and keyboard cable)
- o Terminal serial cable (if Morrow brand, will be 4 feet long, usually colored white) to connect terminal to Micro Decision
- o Printer (optional) with its cable, ribbon, and printwheel, if it's a wheel printer

Diskettes and Manuals

- o 2 CP/M Diskettes and CP/M 3.0 five-book set
- o 1 MBASIC Diskette and Manual (may also say SmartKey on the label, but you can't use SmartKey on the hard disk systems. Use KEY.COM instead -- see Appendix B.)
- o 1 NewWord Diskette and Manual
- o 1 SuperCalc Diskette and Manual
- o 1 Correct-It Diskette and Manual

- o 2 Personal Pearl Diskettes and Manual
- o 4 Quest Bookkeeper Diskettes and Manual
- o Backfield Diskette (details in Appendix A)
- o Warranty Registration Booklet
- o PILOT Manual
- o Hard Disk Micro Decision User's Guide
- o You should have bought your own box of 10 blank 5.25 double-sided soft-sectored diskettes.

You can get by with just one diskette for the moment, so don't rush off to the dealer if you don't have ten.

The only thing that can hang you up is having a truly unusual terminal or printer. Check the lists below to find your hardware, or a model that operates exactly the same as yours. If you don't find them, ask your dealer about the "emulation capabilities" of your terminal or printer. Emulation is the built-in ability of some terminals and printers to act exactly like certain other more popular models.

In any case, you'll still be able to work through all the steps but you may be left wishing you'd bought a more popular model.

Terminals That Work Conveniently With the Micro Decision

Any Morrow model (MDT-60 or MT-70 recommended)
 ACT 5A
 ADDS Viewpoint
 DEC VT52 or VT100
 Hazeltine 1420 or 1500
 Heath H19 (same as Zenith Z19)
 IBM 3101
 Lear Siegler ADM-3A, ADM-5, ADM-22, and ADM-31
 Qume 102
 SOROC IQ-120
 Teleray
 Televideo 910, 912C/920, and 925/950
 Visual 200
 Wyse
 Any ANSI standard terminal

NOTE: You will see the list above if you answer "N" when you are asked whether you are using a Morrow MDT-60 / MT-70 terminal. The question appears soon after you start the system for the first time.

If your terminal (or one that works exactly the same as yours) isn't up there, select "None of the above". Pay special attention to the message that appears onscreen at this point. See also INIT.COM on page 3-10.

Printers That Will Prove Convenient to Use

The Micro Decision will work with practically any printer, but certain programs have their own preferences. Your wordprocessing program, NewWord, is a one of these. When you reach the point of installing NewWord, you'll see this list:

Simple	NEC Spinwriter 2000 series
Draft printer	NEC Spinwriter 3500 series
Typewriter printer	NEC Spinwriter 5500 series
Qume Sprint 11	Okidata Microline 84 (step 2)
Silver Reed EXP550	Okidata models 92/93
Diablo 1610/20/40/50	Epson MX80/100 & FX80/100
Diablo 630	C.Itoh Prowriter

Morrow's MP100/200/300 series

If you see yours in there (or one yours can emulate), great. If not, you'll have to figure out whether yours qualifies as a "Draft" or "Typewriter" printer. Read about this under Printers in the Encyclopedia section of the NewWord User's Guide. (Hint: if in doubt, pick **Draft printer**.)

With those preliminaries behind us, let's move on.

UNPACKING

You don't really need instructions for unpacking, do you? Since you're reading this, you must have exercised a little initiative already. However:

NOTE: Keep your packing materials. The Micro Decision carton was specially designed to give maximum shock protection for the hard disk during shipment.



Attach the Four Rubber Feet

Turn the Micro Decision upside down. Stick one of the four rubber feet (supplied in the Micro Decision box) onto each of the outer corners of the unit's bottom.

SETTING THINGS IN PLACE

There is only one safety restriction: Leave two or three inches clearance behind the Micro Decision for ventilation from its fan.

As a base, any sturdy desk or table top is alright. Treat the hardware as you would a fine component stereo. Here are a few hints that might help you out:

1. Consider the comfort of your arms and shoulders when deciding where to put the keyboard. Most normal desk tops are really too high for long-term typing.
2. Put the screen at a convenient level for your eyes, especially if you wear bi-focals.
3. Make sure you can reach the power switch on the rear of the Micro Decision without too much strain. (It was intentionally put in a less-than-convenient place so you'd never shut it off by accident.)
4. Don't strive for the perfect arrangement just yet. You'll still be moving things around when you're attaching the cables, which comes next.

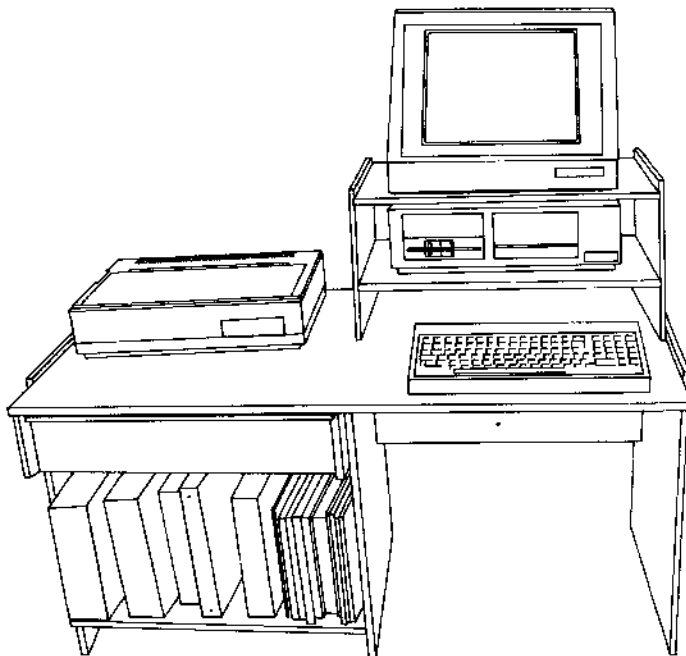

Connecting the Terminal

DON'T PLUG ANYTHING INTO POWER SOCKETS YET.

Locate the cable that came with your terminal. If you happen to have a serial-type printer, the terminal and printer cables might look almost identical. Endeavor not to confuse them. If you do, note that the terminal cable probably has only four pins in each connector, while the printer cable will have six or more.

You'll be happy to know that the plugs on the terminal cable cannot be connected upside down, and it doesn't matter which end of the cable is which. So proceed to connect one end to the **TERMINAL** socket on the Micro Decision, and the other to the socket on the terminal.

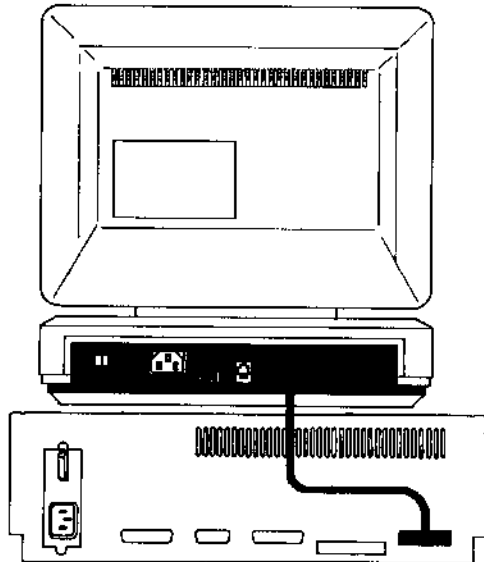

Figure 1-1: Terminal Cable Connection (MT-70 Terminal shown)

If the terminal has two possible places to connect the cable, pick the one labelled **MAIN**, **RS-232**, or **MODEM**. Avoid connectors labelled **PRINTER** or **AUX**. (No damage results, but nothing works either.)

Connecting the Keyboard

Some terminals won't require this step. But most that have detachable keyboards will have a coiled cable that plugs into the terminal somewhere. Check your terminal manual should the socket elude you.

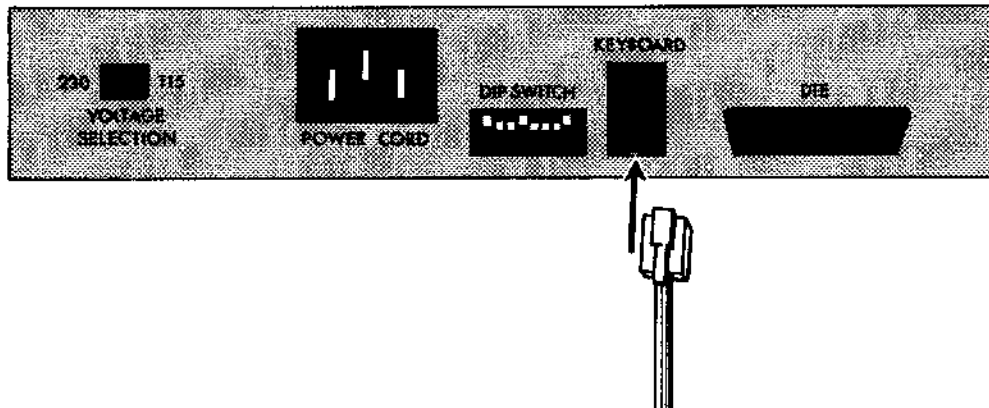

Figure 1-2: Connecting the MT-70 Keyboard

Connecting the Printer

There are two possibilities: you have a serial printer, or a parallel (also called "Centronics") printer. A few printers can play it either way.

Parallel printers usually have wide, flat cables with connectors that differ from one end to the other. Serial printers have thin round cables with connectors just like those on the terminal cable.

Parallel Printers

It should be obvious that one end of the cable matches the oblong connector on the printer. Go ahead and make this connection. You can't do it upside down. If there are little metal clips that fasten the plug to the printer, try clipping them. But if they give you too much trouble, don't worry about them.

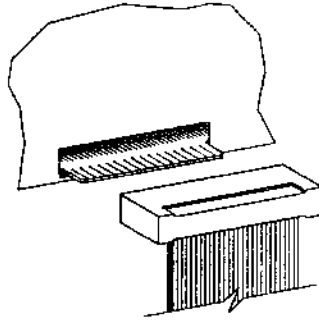

Figure 1-3: Connecting the 34-pin Plug

Now comes the only place where you could go wrong. The other end of the parallel cable attaches to the edge of the board sticking out of the Micro Decision's rear (labelled CENTRONICS PARALLEL). It is possible to connect this one upside down. If you follow the illustration above you'll be alright. The ribbon of wires should flow out of the BOTTOM of the connector.

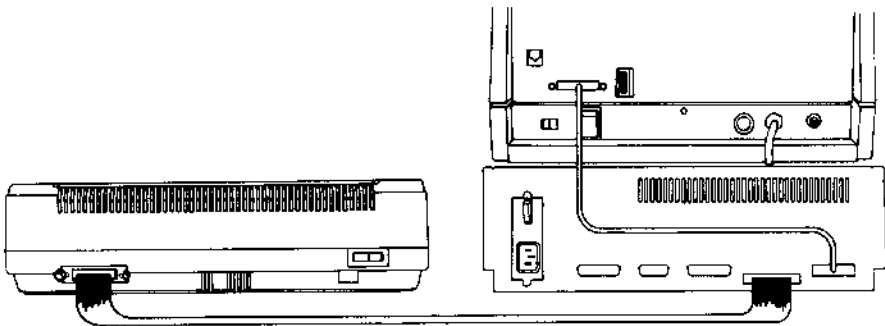

Figure 1-4: Connecting a Parallel Printer (MP-100 shown)

Serial Printers

This is about the same as connecting the terminal. One end of the printer's cable goes to the Micro Decision connector labelled PRINTER / MODEM, and the other goes to the printer. Enough said.

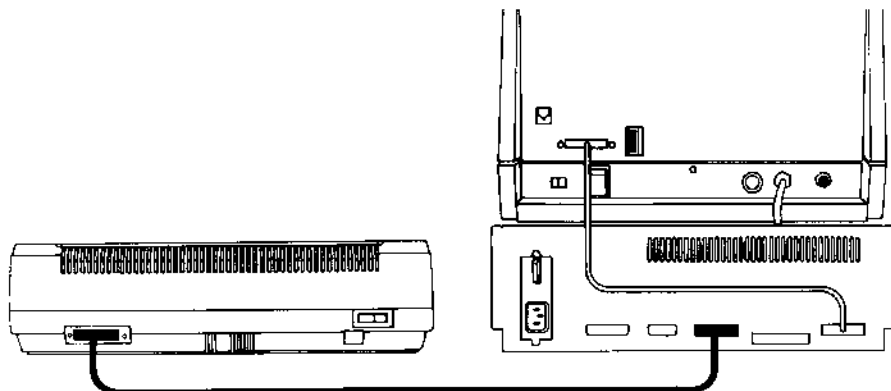

Figure 1-5: Serial Printer Connection (Mythical printer shown)

UNFORTUNATELY, YOU'RE NOT QUITE FINISHED

That was easy enough. Now things can get a little murky. The Micro Decision comes from the factory with a few assumptions built in; you have to make sure that the printer and terminal adhere to these assumptions, and if that's not possible, that you change the Micro Decision's picture of the world accordingly. We'll deal with the terminal now, and the printer a little later.

Terminal Setup

Most terminals have tiny switches on them that determine how they'll communicate with a computer. Others use "software settings" instead of switches. In either case, you need to verify that the terminal is set up right for the Micro Decision. The procedure for doing so is different for every model of terminal, so consult your terminal manual or make your dealer do it. There is a real possibility, however, that your terminal will be set up correctly even before you unpack it.

We'll use the Morrow MT-70 terminal as an example. The assumptions that the Micro Decision is making are these:

Baud rate: 9600
7 data bits
2 stop bits
Full duplex
No parity - parity bit set to "space" (0)

The figure below shows the proper switch settings for the MT-70. (These switches are clearly visible on the rear of the terminal.)

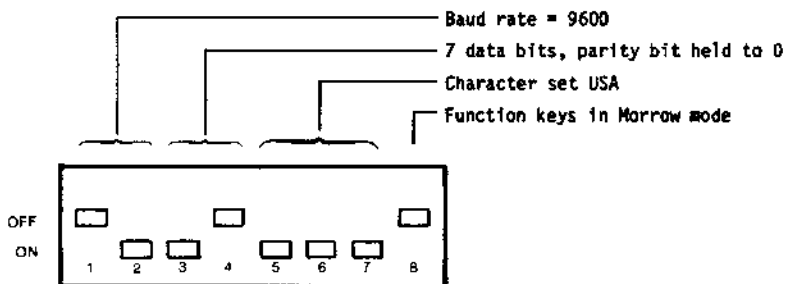

Figure 1-6: MT-70 Setup Switches, Properly Set for the Micro Decision

The few terminals that use software settings for these functions instead of switches (such as the Morrow MDT-20) will require that you plug them in and turn them on before you can check anything. Feel free to do this, but LEAVE THE MICRO DECISION UNPLUGGED.

In the extremely unlikely case that you have an ancient terminal that can't talk at 9600 baud, tell your dealer "Hey - how about running SETUP on this Micro Decision to match my terminal's baud rate?" (a five-minute operation that requires only your Micro Decision to be present, but you'll probably want to take your terminal along to make sure everything's working). He'll have to use a 9600 baud terminal to boot and run SETUP. Then your terminal can take over.

There are several other details about your terminal's operation that are under the control of additional switches. Don't worry about them now. Just focus on baud rate, full duplex, and bit patterns.

Incidentally, we're not pausing to define every term at this stage. If not understanding words like "baud rate" makes you nervous, refer to the glossary in Appendix F. But you can certainly work through these steps without knowing such details.

Checkpoint A

- o Your terminal and printer are connected to the Micro Decision.
- o You've verified that your terminal is set up for the Micro Decision.

THE NEXT STEPS

1. This next step is very important: REMOVE THE CARDBOARD PACKING MATERIAL FROM THE INSIDE OF THE FLOPPY DISK DRIVE. Leave the latch open. Never try to close it with no diskette inside, by the way.
You may want to save this cardboard for protecting the floppy drive whenever you move the Micro Decision. You should always keep the cardboard or a spare diskette in the drive while moving the unit; this keeps the drive's heads from bumping into each other.
2. Make sure the power switch on the Micro Decision's rear is turned OFF. Down is off.
3. Connect the Micro Decision power cord into its socket on the rear panel.

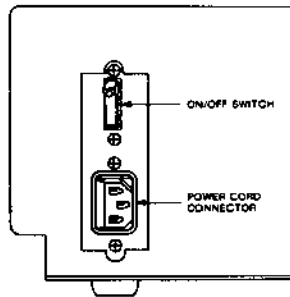

Figure 1-7: Micro Decision Power Connector and Switch

4. Plug the power cords for the Micro Decision, terminal, and printer into a wall outlet or power strip. **USE ONLY GROUNDED OUTLETS.** And don't just break off the grounding lead from the plugs. This is a computer, not a power saw.
5. If you like, go ahead and arrange the hardware into its final positions now.

FIRE THAT BABY UP

Turn the terminal on first. You may hear a beep. In a few seconds, your cursor should appear. The cursor is a small rectangle or bar of light, about the size of one character. It may blink. If you don't see anything on the screen after a reasonable pause, check the terminal's brightness or contrast control. Rotate it from one extreme to the other. If you're sure you have power and you still don't see a cursor, tell your dealer.

Assuming your cursor is there, reach around the right side of the Micro Decision and flip the power switch ON. You should hear the hard disk start to whirl. A light should be glowing on the lower right corner of the front panel.

And voilà. The computer has sprung to life.

Checkpoint B

- o The cursor was clearly visible on the terminal screen.
- o When you turned on the Micro Decision, a message immediately appeared on the screen. Among other things, it reported that it was "Testing memory:". After passing this test, the software installation process commenced automatically.

If everything's gone right so far, stop reading this and read your screen instead.

Several things could have gone wrong at this point, although they're unlikely if you've followed the instructions carefully.

First possibility: When you turned on the Micro Decision, nothing happened. No hum, no lights glowing. Check its power cord connections and the outlet.

Second: Upon turning the Micro Decision on, it hummed etc., but nothing happened on the screen. Assuming the cursor is visible, check the terminal's cable connection.

Third: You saw some kind of gibberish appear on the screen. Most likely your terminal is set to the wrong baud rate. After being sure it's 9600, turn the terminal off and back on to make the new rate take effect. Then press the RESET button on the front of the Micro Decision (the little button on the lower right with the light in it). This starts everything over.

Fourth: The Micro Decision failed the memory test, as indicated by the message "RAM (or ROM) error." We've yet to see this happen, but if you're that one in a million, report it to your dealer.

-- (*) --

Now then. If your hard disk is still in perfect condition after its trip from the factory, you'll proceed to install NewWord, SuperCalc, Personal Pearl, and Backfield for your terminal and printer. This takes thirty minutes or so, and is fully automatic. You do need to be present to answer a few questions. When that's done, you can set up your printer in a way similar to what we did with the terminal (serial printers only).

***** If you aren't using *****
***** a Morrow MDT-60 or MT-70 Terminal: *****

A question appears asking you whether you're using one of these terminals. If you respond "N", you see the list of terminals shown on page 1-2 of this booklet. Pick yours, or one that works just like yours (check "emulation" in the index of your terminal's manual). As a last resort, pick "None of the above", and pay special attention to the message that appears onscreen.

After verifying your choice, a message tells you what "level" your terminal falls into. This is further discussed on page 3-10. For now, we just want you to know that the question "Is the current level OK?" is a good example of bad software design. Of course you'll have no idea what to respond. Unless you made a mistake while picking your terminal, respond "Y".

-- (*) --

Checkpoint C

- o The Micro Decision passed its memory test; the installation procedure went along with no problems; and now the Co-Pilot Main Menu is on your screen. This menu is shown on the next page, so you can be sure you've got your bearings.

C O P I L O T M A I N M E N U

This menu is your copilot through the CP/M operating system. To perform these functions, just type the appropriate number after the prompt below, then follow the instructions given.

1	NewWord	Word Processing
2	SuperCalc	Financial Analysis
3	Correct-It	Spelling Checker / Corrector
4	Personal Pearl	Data Base Manager
5	Quest	Bookkeeper System
6	Backfield	Hard disk backup programs
7	MBASIC	Microsoft BASIC
8	PARK	Hard disk head parking utility
U	Utility menu	
ESC	Exit to CP/M	

Enter your selection: []

The Micro Decision is now ready to go to work for you. If you want to press some keys and put it through its paces, go ahead. However, be aware that if you're using a serial printer you won't be able to print anything yet.

Those of you with parallel/Centronics-type printers are finished with this whole "wire-up 'n fire-up" business. Congratulations.

If You Didn't Make It to Checkpoint C . . .

Several things might have occurred. Either the hard disk couldn't be accessed at all, or it failed the VERIFY test that's run as part of the installation, or the diskette you chose for your Backfield Working Disk had problems, or you pressed keys during the software installation when you weren't supposed to.

In any case, you have a little work to do:

NOTE: DON'T PERFORM THESE STEPS UNLESS YOU HAD INSURMOUNTABLE PROBLEMS BETWEEN CHECKPOINTS B AND C. IF YOU MADE IT TO THE CO-PILOT MAIN MENU, THIS IS NOT FOR YOU!

1. Locate the diskette that came with the Micro Decision labelled "CP/M Distribution Diskette #1". Insert it in the floppy drive and close the latch. See Chapter 6 if you don't know how to insert diskettes.
2. Without turning anything off, press the RESET button on the front of the Micro Decision (the little button on the lower right corner with the light in it).
3. When you see "Do you want to boot from the floppy disk? (Y/N)", type **Y**. Then follow the instructions that appear on the screen for reformatting the hard disk and recopying the software onto the hard disk from the other diskettes you received. When you see "Press C to continue or S to stop", always press **C**. If for some reason you must stop, just start over again at the beginning.
4. Keep following the onscreen instructions until the Co-Pilot Main Menu appears on the screen.

SETTING UP SERIAL PRINTERS

Owners of parallel-type printers should ignore this section.

Okay. Let's assume you've made it to the Co-Pilot Main Menu. The Micro Decision comes from the factory under the reasonable impression that you'll be using a parallel printer. So before you can print anything, you need to set the record straight.

This process is quite similar to setting up a terminal. However, it's a bit more interesting, as it gives you your first experience with using the CP/M operating system directly (as opposed to using it through the menu system).

Before proceeding, get your printer manual - or call your dealer - and extract this information: how to set the printer to 1200 baud, and whether it can handle XON/-XOFF (software) handshaking. In some rare cases, your printer might not work at 1200 baud; it may be stuck at 300 or 2400. If so, make a note of this.

Ready?

1. At the Co-Pilot Main Menu, press the ESC (escape) key on your keyboard. After a message or two, you'll see "A>", with the cursor to the right.
2. Type **setup** and press the RETURN key.
3. You should be looking at something like this:

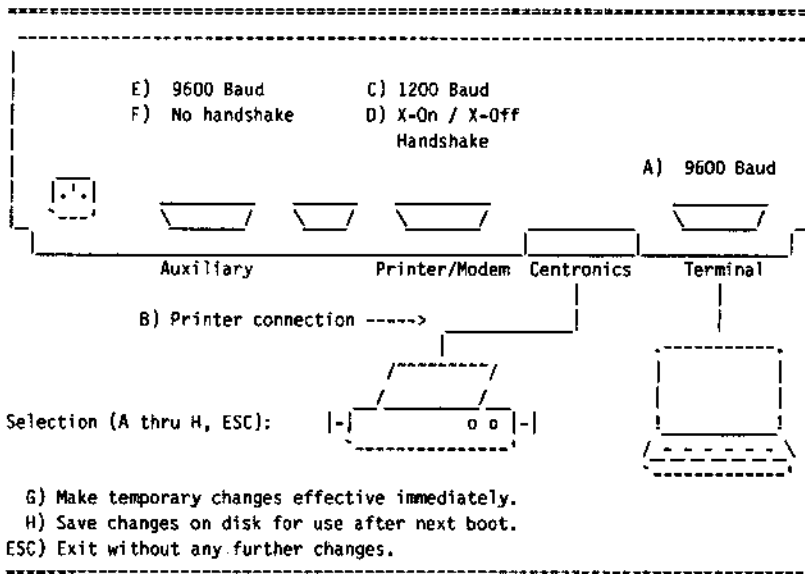

You'll be interested in the options B, C, D, G and H.

1. First type B. The Printer Connection display changes to PRINTER / MODEM, which is where you've put your serial printer cable.
2. IF your printer is stuck at some baud rate other than 1200, press C until its baud rate is shown next to "C)". If you accidentally pass the number you want, keep tapping C until it comes around again.
3. IF your printer can't use XON/XOFF handshaking, press D and watch XON/XOFF change to HARDWARE.
4. When all of the items are set up right, press G, then H, and finally ESC. You should see "A>" again.
5. Type **pilot go** and press RETURN. Now you're back at the Main Menu.

The only thing that would prevent your printer from working now (assuming it's in good shape) is a defective or improperly wired cable. If you're using HARDWARE handshaking, the cable must have a wire running from pin 20 on the Micro Decision end to the "Clear to send" pin on the printer end. See also page D-5.

Keep in mind that most printers require that they have paper and ribbon (and sometimes printwheel) installed before they'll work. They also probably have an "on-line" switch that must be turned ON.

Finally, if the printer prints but it's "garbage," you most likely have a baud rate mismatch. Run SETUP again when you figure out the right speed. If it prints fine for a while and then goes haywire, you should try running SETUP again, this time changing the handshaking to HARDWARE or XON/XOFF, whichever it currently is not.

-- (*) --

Thus ends the saga of setting up the computer. Perhaps a bit more involved than a VCR, but not much. You may now tinker around with your programs, which are introduced in the next chapter.

CHAPTER 2

USING YOUR MICRO DECISION FOR THE FIRST TIME

This chapter introduces all of the functions that are available through your Co-Pilot menus. Pay special attention to the PARK command (DON'T turn the Micro Decision off until you've read about PARK), and the need for backing up your files.

A word to the wise for those who haven't heard this about computers yet: If you unplug a computer, or turn it off, or even press the RESET button while a program is running, the computer forgets everything it was doing. Therefore you run the risk of losing data when this happens. The programs themselves, however, should suffer no damage.

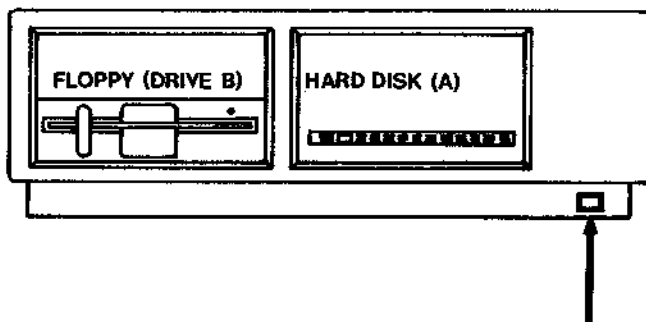

Figure 2-1: Location of the Reset Button
In general, avoid pressing it.

Contrary to this warning, if you get completely stuck or lost in the exercises that follow, go ahead and press the RESET button, but DON'T TURN THE MICRO DECISION OFF (since you won't have PARKed it). Resetting will be alright because you won't be doing anything that risks data. See page 2-12 for parking instructions.

It takes a good while to try everything in this chapter. If you want to stop in the middle, select PARK from the Co-Pilot Main Menu before turning the Micro Decision off. See page 2-12.

REMEMBER. . .

PARK!
PARK!
PARK!
PARK!
PARK!
PARK!
PARK!
PARK!

MAKE IT A HABIT.

The Main Menu, Revisited

=====

C O P I L O T M A I N M E N U

This menu is your copilot through the CP/M operating system. To perform these functions, just type the appropriate number after the prompt below, then follow the instructions given.

- | | | |
|-----|----------------|--------------------------------|
| 1 | NewWord | Word Processing |
| 2 | SuperCalc | Financial Analysis |
| 3 | Correct-It | Spelling Checker / Corrector |
| 4 | Personal Pearl | Data Base Manager |
| 5 | Quest | Bookkeeper System |
| 6 | Backfield | Hard disk backup programs |
| 7 | MBASIC | Microsoft BASIC |
| 8 | PARK | Hard disk head parking utility |
| U | Utility menu | |
| ESC | Exit to CP/M | |

Enter your selection: []

=====

As you can see, selections 1 through 7 run the software programs that came with your system. Selection 8 PARKs your disk heads so you can safely turn the Micro Decision Menu off. Typing the letter U will give you the Utility Menu, which is discussed beginning on page 2-14. The ESC key, usually located on the upper left of your keyboard, will take you out of the menu system so you can enter CP/M commands directly. Let's look at these selections more closely.

A SAMPLING OF THE SOFTWARE

This exercise has two purposes: to demonstrate how to run your software directly from the Main Menu, and to check that all software has been properly installed on your hard disk. We recommend you take this tour to get to know the lay of the land.

If you find that some of your programs are not starting up right, call your dealer. This excludes Quest, which is not yet present on your hard disk for reasons we'll get to later.

```
*****
*
* NOTE: Your software manuals have a tendency to
* assume you're using a floppy-only computer. For
* example, page 13 of Personal Pearl tells you to
* "insert your PROGRAM and DATA disk into drive B."
* NewWord has you logging onto drive B on page 5-2 of
* the "Do It Yourself."
*
* Well forget that stuff. Everything you need, data
* and programs, is all on drive A, the hard disk.
*
* You can change the logged drive and user number at
* the NewWord Opening Menu nonetheless, but there's
* no need for you to do so yet.
*
*****
```

NewWord

NewWord is your wordprocessing program. For most people, this is by far the most frequently used program. You can use it to generate any text, such as memos, books, form letters, and computer programs.

NewWord has a fairly good manual, perhaps the best among the set you received. Note, however, that you should disregard Chapter 2 of that book. It gives lengthy installation instructions that don't apply to the Micro Decision.

- o Select NewWord from the Main Menu by typing 1. The next thing you see is:

```
-----
1.
    ====
-----
2.
    ====
-----
3.
    ====
-----
```

You have three NewWord filing drawers available. They correspond to User Areas 1, 2, and 3. Files you create will go in the drawer you open now. To work with an existing file, first select the drawer which contains the file.

- 1 Open drawer 1
- 2 Open drawer 2
- 3 Open drawer 3
-
- D Display a drawer's contents
- ESC Return to Main Menu

Select 1, 2, 3, or D: []

This screen was not shown by NewWord. NewWord hasn't started yet. This is still part of Co-Pilot. Here's what it means:

Your hard disk can hold so many files, there has to be some method for grouping them together in a logical way. CP/M 3.0 does this by assigning every file a **user number**. It can range from 0 to 15. One user number is "current," or in effect, at any given time.

Whenever you create a file (say, by typing a recipe with NewWord), the file is assigned the user number that is currently in effect. Co-Pilot uses this feature by setting the current user number before starting NewWord.

Therefore any file you create will have user number 1, 2, or 3 -- that is, it goes into whichever "drawer" you pick. Later, if you want to revise or print the file, you need to pick the same drawer that you did when you created the file.

Most of the remaining user numbers (4 - 13) are assigned to the other programs. SuperCalc, Personal Pearl, and Quest each have three of their own; BASIC has one; two (#14 and #15) are reserved for you to use as you please after you learn about CP/M. User number 0 is a special case: it holds all of your programs.

- o Try pressing **D**, to look at a directory. Then pick drawer #1's directory by typing **1**.
- o You should see three file names. These are sample files used in training exercises for NewWord. They were given user number 1 as part of the NewWord installation procedure.
- o Press any key to get back to the NewWord filing cabinet. Now type **1** to "open" drawer 1.
- o Momentarily, you're presented NewWord's Opening Menu. If you would like to see whether your printer's hooked up and adjusted right, type **P**. Then type **SAMPLE1.DOC** and press the **ESC** key. (The name doesn't need to be in upper case.)
- o If your printer is set up right and is on-line, it should begin printing. If not, and you can't figure out what to do, press the **RESET** button on the front of the Micro Decision. In this case nothing bad will happen; you'll just have to start over.
- o If the printout worked, type **X** when it's finished. You'll exit from NewWord back to the Co-Pilot Main Menu.

We leave it to you and the NewWord manual to proceed from here. IGNORE CHAPTER 2 OF THAT MANUAL! It gives lengthy installation instructions for NewWord; this was handled for you already. There are some useful facts about CP/M in there, however.

Pay special attention to the need for "saving" data on disk. You can't print or rework a NewWord document without saving it. This is true of data associated with virtually any business program. Saving makes a copy of the data from its temporary storage in RAM memory to the disk, where it's safe from power interruptions or resets.

NOTE: NewWord undergoes regular enhancements. Additional information about advanced features of NewWord can be found in the Correct-It User's Guide, and if included with your system, a set of NewWord upgrade notices.

SuperCalc

This is your "electronic spreadsheet." It lets you set up small (or huge) tables of numbers and objects, among which you define mathematical relationships. Then you can change one number, and immediately see how that impacts everything else. For example, you could plan an investment strategy with certain assumptions about, say, the Dow industrial average and your anticipated tax bracket. Then you can change the Dow and see how much better municipal bonds look.

- o At the Co-Pilot Main Menu, type 2. The filing cabinet (explained on page 2-4) takes over, but this time the drawers correspond to different user numbers (4, 5, and 6). Pick any drawer.
- o Now SuperCalc is in control. Its first screen serves no particular purpose, other than making sure you really want to run SuperCalc. Press **RETURN** to keep going.
- o And zap! What you see now is the upper left corner of a blank spreadsheet that is much too large to fit on your screen all at once. You're ready to begin at page 3-1 of the SuperCalc manual.
- o But now may not be the time for an in-depth look at SuperCalc. There's much more ground to cover, so type /q for "quit" and verify with a Y. Back to Co-Pilot.

Correct-It

Correct-It finds and fixes spelling errors in files you created with NewWord. It is not totally automatic by any means, but is still quite helpful and easy to use.

- o At the Co-Pilot Main Menu, type 3. You'll see those familiar filing drawers once again. This time they are the same user numbers as for NewWord, since you'll be correcting NewWord documents. Pick the number for the same drawer as you used when you typed the file with NewWord (which you haven't done. So for the sake of practice, pick any drawer.)
- o Then you see:

```
=====
Correct-It: Morrow Designs Spelling Checker V1. 01
           Licensed from Aspen Software Co. (c) (p) 1982
```

```
Enter name of file to check:
```

- ```
=====
```
- o This is a good time to show you a little trick. Since there's no file to correct yet, you must exit by typing "control-C". This means: Hold down the key labelled CTRL on your keyboard, and while holding it down, tap the C key. Thus you use the CTRL key like a SHIFT key on a typewriter. You'll get to know the CTRL key very well as the years go by.

Don't overlook the little booklet Correct-It User's Guide. It contains all of the operating instructions for Correct-It. It also tells how to set up NewWord if you have an unusual terminal or printer. It also contains valuable tips on using NewWord's merge-print. (That section was adapted from a MorroWriter document so there are a couple of unintentional references to the "MorroWriter Encyclopedia." Sorry.)

## Personal Pearl

Personal Pearl is a "relational data base management system," which is a fancy way of saying it stores a seemingly infinite array of little facts. Then at your command, it digs out the ones you want, sifting and sorting in ways you select, finally giving you a report according to your design. For example, you could ask Pearl to print a list of all the people who owe you money, sorted in reverse alphabetical order by middle initial.

- o At the Co-Pilot Main Menu, type 4 for Pearl. Again you see the file cabinet (described on page 2-4); this time the drawers correspond to user numbers 7, 8, and 9. Pick a drawer, any drawer.
- o Another menu! You are still in the Co-Pilot system. This is a list of the various modules that make up Pearl. Select 1, for the "Welcome" program. If you can, try to remember what your screen said back at installation time about which terminal to select when running Welcome.
- o After a pause, a list of terminals appears. Pearl has finally taken over. Picking a terminal is required only with Welcome, not with the other modules (Design Forms, etc.).
- o If you've forgotten what your screen told you about your terminal, try ADM-3A or Micro Decision Level I. (Should your terminal lock up a screen or two down the road, feel free to RESET and try something else.)
- o At the "Demonstrate or Personalize" option, pick D. You already personalized Pearl during the installation. The demonstration is self-explanatory. When you've had enough, press the ESC key as many times as necessary to back up until you finally return to the Co-Pilot Main Menu.

## Quest

NOTE: Your hard disk does NOT come with Quest already loaded (i.e. present). This is because it requires a lot of disk space and not everyone will want to use it. You load it onto the hard disk from diskettes yourself with the Utility Menu option "Load Quest Bookkeeper." This option is covered starting on page 2-23.

Quest is a bookkeeping system for Accounts Receivable, Cash Disbursements, and General Ledger. It too has a built-in demo program that we'll run in this exercise.

- o At the Co-Pilot Main Menu, type 5. Here comes that filing cabinet again! This time the user numbers are 10, 11, and 12. Pick a drawer.
- o The first thing you must do is specify a date in the format MMDDYY (that is, August 4, 1984 is 080484).
- o Then type 98 and RETURN for function 98, demonstration.
- o When you're ready to quit, type \2. That's the "backslash" key, not a regular slash. Then RETURN.
- o Back at the Quest starting menu, type 99 and RETURN for exiting back to Co-Pilot.

NOTE: There is a \$37.50 support fee that Quest users must pay to Quest, Inc. before they can close out a period. Some users react with outrage at having to pay even a nominal fee for "free" software. The justification is this: Quest, Inc. will answer your phone calls and try to help you out with any problems you're having. This is very expensive for them; and that's why very few companies offer that kind of support. Hence the support fee. If you don't plan to use Quest, it costs you nothing. But if you do, it's well worth the price.

## The Backfield

Eureka! You have discovered one of the two extremely important maintenance programs for your hard disk (the other being PARK). Backfield is actually a set of programs that copy files from your hard disk onto floppies, and back again if necessary. When you run Backfield through the menus, the most commonly-used options are automatically selected for you. Other options are available if you run Backfield directly from CP/M. They are discussed in the Backfield Users Guide (Appendix A).

The value of such programs is the insurance they provide against lost data, should anything happen to your hard disk. In the old days of floppies, if a diskette was scratched or exposed to magnetism, you might lose 400K of data. With a hard disk, you stand to lose from ten to eighty times that much!

Backing up important files was crucial in floppy times, too. But it was easy to copy a floppy; it took about 5 minutes. Backing up a hard disk has traditionally been time-consuming and painfully tedious. That is what's so nice about Backfield: it's fast and convenient. So you have no excuses for not using it.

In this section we're going to make the first full backup of your hard disk. This will be the same process you should go through once every one or two weeks. There is a shorter, faster process you should use every day, which we won't cover here.

**You'll need seven blank soft-sectored diskettes.** Be sure they're certified for double-sided and double-density use.

- o At the Co-Pilot Main Menu, type 6. You'll proceed to the Backfield Options Menu.
- o Select item 1, to format your diskettes. The screen leads you through this. Go on to the next step after all seven diskettes have been formatted. (Note: if a diskette fails the verify portion of formatting, throw it away or return it to the dealer.) You'll be able to recycle these diskettes with your next full backup, so this step won't be needed each time.

- o Now select item 3 - Backup the entire hard disk.
- o The next thing you have to type is the "date or other ID code." The date will be fine. Type it in the format MM/DD/YY. (The Backfield manual lists the restrictions on ID codes.) Press RETURN.
- o The Backfield module "FULLBACK" tells you when to change diskettes and how to label them. We recommend you label them: Full Backup, (Date), V. 001. Add 1 to the volume number as you proceed through your stack of diskettes. (You may not really need all seven.)
- o When you're done, you are automatically returned to Co-Pilot.

Now that wasn't so bad. And you only have to do this once in a while. EVERY DAY, however, you should select Backfield item #4 - Backup only those files that have changed since the last daily or weekly backup. You should only need one (formatted) diskette for this; it takes much less time; and you can use the same diskette each day. DON'T use any of the diskettes that you just filled with the full backup.

NOTE: You should read the first few pages of Appendix A as you're becoming familiar with Backfield. It will clear up some of the confusion users have reported in using the program.

Store all of your backup diskettes in a very safe place. You may never need them. You may never need your Homeowner's insurance, either. But then again . . .

See Appendix A for complete details on Backfield.

## Microsoft BASIC

We're not going to use this right now. You have enough to think about without learning how to write BASIC programs too. But it's there if you're interested. MBASIC has only one user number dedicated to it (#13), so you won't see the file cabinet screen.

## PARK

You wouldn't just hop out of your car and let it roll off to wherever the laws of physics led it, would you? (Not unless you're trying to stash a body in some swamp, anyway.)

Just like you park your car when you're done with it, you need to PARK your computer.

What really goes on here is this: your disk heads are not supposed to be in actual contact with the spinning disk. That would damage the magnetic surface of the disk and clog the heads. Instead, they ride on a thin cushion of air just above the surface. That air cushion is created by the spinning of the disk, so when the disk stops, the heads fall into contact with the disk (the nefarious "head crash").

Disk manufacturers supply a special part of the disk called the "parking area." Here the heads can safely land without damage to them or the disk. You need to be sure the heads are positioned over the parking area before you interrupt power to the computer. This is what the PARK program does.

```

*
* NOTE: ALWAYS PARK YOUR HEADS BEFORE TURNING
* OFF OR UNPLUGGING THE MICRO DECISION. ALWAYS.
* AND TO BE REALLY SAFE, PARK BEFORE TURNING YOUR
* PRINTER OR TERMINAL OFF, TOO.
*

```

In fact, just for the heck of it, why don't you do it right now?

- o At the Co-Pilot Main Menu, type 8.
- o When you see "You may now turn the power off to your system," you're safe.
- o Press the RESET button - or turn the power switch off and back on, to get back to the Co-Pilot Main Menu.

### ESC: Exit to CP/M

This means: press the ESCape key, and the man behind the curtain will be revealed!

If you're already a computer whiz who knows your way around the CP/M operating system, this was probably the first key you pressed. The rest of you should follow these instructions:

- o Press the ESC key to break out of the menu system.
- o You'll see "A>". This is the CP/M prompt, that means the Micro Decision is ready and waiting for any valid CP/M command. "Valid" is the tricky part: CP/M is extremely picky about the commands you can enter and how they must be typed. Hence the Menus, to get around the frustration this can cause for beginners.
- o Try this most basic of commands. Type `dirs` and press RETURN. Keep pressing RETURN to see all the pages of files on your hard disk. Are you sufficiently impressed? And you haven't even begun to fill the disk up with your own stuff.
- o When the directory listing is done and A> returns to your screen, type `pilot go` and press RETURN. This takes you back into the menus.



**THE UTILITY MENU:**  
**YOUR TOOL BOX**

Let's take a look at the Co-Pilot Utility Menu now by typing U at the Main Menu. You should see:

=====

C O P I L O T     U T I L I T Y     M E N U

This menu allows you to perform a number of everyday utility functions. Simply type the number next to the function you desire.

- 1     Display a directory
- 2     View or Print a file
- 3     Copy a file or files
- 4     Format a diskette
- 5     Check disk space and file size
- 6     Execute a CP/M command
- 7     Rename or erase a file
- 8     Fundamental training in CP/M
- 9     Load Quest Bookkeeper
- ESC   Return to Main Menu

Enter your selection: []

=====

The Utility Menu lets you do certain household file chores without any knowledge of CP/M. Later on, when you learn enough about CP/M, you may never use this menu. But until then, it will be a good friend.

**Display a Directory**

A directory is a list of the files on a disk. This selection is the same as typing `dir [full]` at the `A>` prompt. (See pages 4-21 to 4-23 for more on "A>".)

- o Go ahead and type 1. When you're asked for a user number, answer 0 and press RETURN.

- o This is the same list of files you saw earlier when you typed "dirs" at the A> prompt. But now the format is different; there's more information. For example:

```
=====
BACKUP COM 4k 23 Sys RW
=====
```

Briefly, this means: You have a file named BACKUP.-COM that has been allocated 4k (4000) bytes of space on the hard disk. It consists of 23 records that are 128 bytes long each. (23 times 128 is substantially less than 4000, but hard disk space is allocated in 4k chunks; therefore a file 1 byte long will still show 4k in its "Bytes" column.) Its attributes are Sys for "system" and RW for "read and write."

You can find out more about DIR and "attributes" like Sys with the "Fundamental Training in CP/M" option. This is the eighth selection on the Co-Pilot Utility Menu, and we'll talk about it in a minute.

### View or Print a File

Suppose you've been working with NewWord for some time. One of your file drawers now has files in it named LETTER.A, LETTER.2, LET, 25LET, and LETR. You've had a nervous breakdown and now you simply can't remember which file is which. (One problem is your less than wonderful way of naming files.)

You could run NewWord and scan through each of these files, but there's a faster way: the CP/M **type** command. This command scrolls a text file up your screen so you can scan it. It pauses after each screenful and waits for you to press a key before showing the next screenful.

That's all well and good. What we didn't say is that "View or Print a File" on the Utility Menu doesn't use the **type** command, because of problems between PILOT and the nature of **type**. It uses a CP/M command called **pip** instead. (**pip** is also used by the "Copy a File or Files" option.)

Let's give this a try:

- o At the Co-Pilot Utility Menu, type 2. When asked for the file's name, type **practice.doc** and press RETURN.
- o For user number, type 1 and RETURN.

Now for a brief lesson in CP/M Control key codes. The file you are going to look at (one of NewWord's practice documents) is about to whiz up your screen faster than even Evelyn Wood could handle. This is a weakness of the **pip** program, as opposed to **type**, which stops after each screenful automatically.

To freeze to scrolling, use **CONTROL-S**. That is, hold down the CTRL key and tap the S. To resume the scrolling, use **CONTROL-Q**. To stop looking at the file before it is finished, type **CONTROL-C**. Got it? (Hint: If your keyboard has a "No Scroll" key, it has the same effect as both CTRL-S and CTRL-Q.)

- o When asked "screen or printer," type **S**. Keep your eyes on the screen and your fingers on the keys.

If you want to send a file to your printer as well, you'd type **P** instead of **S** above. But be aware that your printer has to be ready: power on, on-line, paper & ribbon in place, cable connected . . . all the steps we covered in the first chapter. Trying to print when the printer isn't ready could bring everything to a halt. But don't fret. Just press the Micro Decision's RESET button and start over. **DON'T** turn the Micro Decision off, since you haven't **PARKed** it!

### Copy a File or Files

There is many a use for this handy fellow. For example, Personal Pearl lets you print reports into a disk file instead of sending them out to the printer. Suppose you want to edit the report to change its format or fix typos. Or maybe you want to include it as part of a larger document. To do this, you need to copy the Pearl output file from its file drawer into one of NewWord's file drawers, so you can get to it with NewWord.

Other examples: copying new software from a floppy onto the hard disk. Backing up a file or two onto floppies from the hard disk. Rearranging the distribution of files among the 16 user numbers (which is really what the example in the first paragraph is doing).

To try this function, **format a blank diskette first** (page 2-18) and come back when that's done.

- o Insert the formatted diskette into the floppy drive and close the latch.
- o At the Co-Pilot Utility Menu, type 3.
- o For the "original's" name, type **pip.com** and RETURN. Then give 0 as its user number.
- o For the copy's name, type **B:pip.com** and RETURN. The letter B and colon say "put the copy on drive B, that is, the floppy drive." Give 0 as its user number also.
- o Co-Pilot makes sure you've typed what you meant to type and gives you a chance to change it. If the last line on the screen reads "You want to copy **pip.com** in user 0 to **B:pip.com** in user 0. Is that right?", then all is well. Type Y.
- o When the copy is finished, you can pick option 1 to look at the floppy's directory, and lo! you'll find **pip.com** on a formerly blank diskette. Good work.

Incidentally, what you've done here is copy the copy program. You've piped pip. Once you've learned your way around CP/M, pip will probably be one of your most common commands.

## Format a Diskette

New blank diskettes have to be formatted before you can store anything on them. Formatting sets up a circular grid in the magnetic surface of the floppy that serves as a sort of road map to files. The Micro Decision has a program `format.com` written by Morrow specifically for its diskettes.

Just in case you didn't know, you can recycle old diskettes by re-formatting them. BUT - **everything on the diskette will be gone after formatting!** So never reformat a diskette unless the information on it is useless or has been copied elsewhere.

You've already formatted diskettes if you followed the directions for backing up the hard disk under "Backfield." In case you didn't (shame on you), let's go through it:

- o Find a blank diskette. Surely your dealer didn't let you leave the store without buying a box.
- o Insert it in the floppy drive and close the latch.
- o At the Co-Pilot Utility Menu, type 4. Follow the instructions on the screen. Pick 1 for normal, double-sided diskettes.
- o That's all there is to formatting.

If you run `format` directly from CP/M, you'll have more questions to answer, such as drive to format ("B" for floppies) and single vs. double sided. The hard disk Micro Decision and MD-3 computers can read single or double-sided diskettes, but you obviously get twice as much storage space with double-sided diskettes. The MD-2 computer can read only single-sided diskettes; so if you want to share a file with an MD-2, you'd have picked 2 above instead of 1.

## Check Space and File Size

Even though your hard disk can hold thousands of pages worth of text, numbers, and programs, it will get full eventually. Faster than you think. So you need to keep an eye on it. It is rather upsetting to have typed twenty inspired pages, only to find that you can't save them on the disk because there's no room left.

- o At the Co-Pilot Utility Menu, type 5.
- o Since we want to check the space left on the hard disk, select 3 from the next list that appears.

Of the lines that follow, the one of interest reads:

```
A: RW Space: #####
```

The "RW" means that you can read from the disk and write to it as well. This is another attribute, like "Sys" we encountered on page 2-15. By contrast, disks can be set as "read only" as a protection against accidental changes or deletions. The "#####" should really be some number on your screen, like 7,800k. This means you still have room for almost 8 million characters ("k" signifies 1,000 bytes). So take a deep breath and relax.

What do you do when the hard disk starts getting dangerously full? And how full is dangerous? Well, when you have only 1000k (1 megabyte) left, you better start erasing unneeded files. Dormant files that should be saved would be copied onto floppies and then erased. Be aware that the fuller your hard disk becomes, the longer it takes to find and transfer information. Try to maintain a lean and mean machine.

You probably noticed that the "Check Space and File Size" option lets you keep track of how full a floppy is getting, too. You could use this to make sure a file will fit on a floppy before attempting to move it there. You'd also check the file's size with this same option. Look in the "Bytes" column of the resulting report.

### Execute a CP/M Command

This option is on the Utility Menu as a hand-holding way of letting you run CP/M commands. You may want to run a command (like `setup` or `cpm2`) that isn't available through the menus. Or you may want to take a short cut by entering a complete `pip` command, even though "copy a file or files" is there on the menu.

Selecting this option is almost like escaping from the Co-Pilot Main Menu with the ESC key (p. 2-13); the difference is that you automatically come back into the menus after running a command with this option.

Let's give it a try:

- o At the Co-Pilot Utility Menu, type 6.
- o Where it asks `COMMAND?`, type `hdhdh` and RETURN.
- o CP/M says "HDHDH?". This means, basically, "What?"

You have typed a nonexistent command. The response of `HDHDH?` is the harsh punishment inflicted on you by CP/M for wasting its time with nonsense. The point is, CP/M is really rather stupid; it isn't bothered in the least if you enter a command incorrectly; it just twiddles its thumbs and doesn't do a thing - or, worse, sends you some mysterious error message. And it will happily continue to do so all day long, with infinite forbearance, until you smash the computer.

So you see, you have nothing to be anxious about but anxiety itself.

- o Type `CONTROL-C` to continue. By now you should know that this involves holding down the `CTRL` key while tapping `C`.
- o We'll do something real this time. Pick 6 again.
- o At `COMMAND?`, type `user 1` and RETURN.
- o When you see `1A>`, type `dir` and RETURN.
- o When `1A>` shows again, type `user 0` and RETURN. We'll return to the menus in just a minute.

If you're highly analytical, you'll have learned a lot from this little exercise. First you changed the current user number from zero to 1. The "1A>" signifies this; it also signifies that drive A (the hard disk) is the current drive.

Then you displayed the directory of drive A, user 1. These are the practice documents for NewWord. Has a light bulb flashed on in your brain? User 1 is the same as NewWord's "file drawer" number 1, just as user 4 is SuperCalc's file drawer number 1.

Finally, you switched the current user number back to 0. When a CP/M prompt like A> appears with no number in it, that means zero is the current number. You'll never see "0A>".

- o We're going to run one more command that's crucial to the success of the exercise in "Rename or Erase a File" on the next page. First, make sure the diskette with **pip.com** on it is in the floppy drive. You made the diskette back on page 2-17 under "Copy a File or Files."
- o At A>, type: **set B:pip.com [rw]** and press RETURN. You should get a message confirming the operation. Be sure that "B:" is right in front of "pip.com". If you get an error message instead, check your typing and try again.
- o Press **CONTROL-C** to get back to the menus. By now you should know this means tap C while holding down the CTRL key.

The "Fundamental Training in CP/M" option on the Utility Menu introduces you to most of the common CP/M commands. You might also read the CP/M User's Guide that came with the Micro Decision for further information (just this one book - not the whole set of five).



## Rename or Erase a File

There's no real significance in the fact that these two commands are on the same option; they're both important, but we didn't want to clutter the menu with too many selection numbers.

It's obvious why you'd want to erase a file: to make room when you don't need it anymore. But why rename one? Several possibilities:

1. You gave a file an unwieldy name to begin with, like "REELYBAD.NAM". Typing it frequently becomes a chore, so you rename it to "BAD".
2. You want to edit one of NewWord's ".BAK" files. (You'll understand this when the time comes.)
3. You want to copy a file onto the hard disk, but there's already a valuable file on the disk with the same name as the one you want to copy. Unless you rename the file that's already on the disk, it will be erased when the new file is copied.

We're going to rename a file, and then erase it. With these instructions you'll need the diskette with **pip.com** on it that you made earlier under "Copy a File or Files." This is only because we don't want to mess around with the hard disk yet. You also need to have followed the final steps in the last exercise, "Execute a CP/M command."

- o Insert the diskette with **pip.com** on it into the drive and close the latch.
- o At the Co-Pilot Utility Menu, type 7.
- o Then pick 2 to Rename a File. Give **B:pip.com** as the old name of the file. Before you press RETURN, make sure that "B:" is the first part of your response. Type 0 and RETURN as its user number. Then type **newname** and RETURN as the new name (such a staggering imagination!).

- o When you've checked that everything was typed right - especially the "B:" part - type Y to continue.

You can now use Utility Option 1 to look at the floppy's directory. If "newname" is there, you know all you need to know about renaming files.

Now we'll get rid of **newname** altogether.

- o Pick 7 from the Utility Menu again.
- o This time, select 1 to Erase a File.
- o Type **B:newname** as the file to erase, with user number 0. Verify with Y.

If you look at the floppy's directory now, you won't see much. Farewell forever, Mr. Newname.

### Fundamental Training in CP/M

This is your best place to start learning about CP/M. It is an "on-line tutorial," which is a jargonistic way of describing basic information that appears on your screen.

There really isn't anything to explain about it. Go ahead and give it a shot, unless you're just entirely beat. It will always be there when you're ready.

### Load Quest Bookkeeper

Unlike the rest of your application programs, the Quest Bookkeeper is not shipped already loaded onto the hard disk. The reason behind this is that Quest takes up over 1 megabyte per copy. Since many users will not be keeping books with the Micro Decision, we leave it to those who will, to copy Quest from diskettes onto the hard disk.

The procedure is simple to an extreme. Pick option 9 (Load Quest Bookkeeper) from the Co-Pilot Utility Menu, and follow the instructions that appear on the screen. You will need to have the four Quest Distribution disks on hand.

## Installing Quest

Installing is different from loading. Installation consists of zeroing out the sample data files so you can begin entering your own real data. Some files are also processed with your company name to make sure that each copy of Quest is dedicated to a particular company.

You would normally install Quest after you've tried it out in "instructional mode" and decided it's worth the \$37.50 registration fee. After installation, you can use all of Quest's functions except period close. For this, you need a special code that Quest, Inc. sends you upon receipt of the registration fee.

To install, follow these steps:

- o Escape from the Co-Pilot menus by pressing the ESC key at the Main Menu.
- o When you see "A>", type **user 10** and press RETURN.
- o When you see "10A>", type **kins** and press RETURN. The screen will prompt for some necessary information. Please note:

The company name must exactly match the registered name as sent to Quest, Inc.  
The company address you enter will be the one used on A/R statements.  
You can expect to need the special code from Quest, Inc. 30 days after the day you run "kins".

- o Type **pilot go** to return to the menus.

Also note that if you have loaded multiple copies of Quest onto the hard disk, each copy requires it's own code and registration fee. To install additional copies, the steps are the same except the number in the "user" command will be 11 or 12. (One reason to have a second copy of Quest without keeping two sets of books is so one copy can stay in instructional mode, to train new operators. There is no fee for a copy that stays in instructional mode.)

### Improvements in Bookkeeper II

The version of Quest you received with the Micro Decision is an upgraded version of the original Bookkeeper I. So there are a couple of new features that are not covered in the Quest manual:

- o Customer statements may be printed using the A/R Reporting program.
- o The customer file now includes addresses.
- o A 13-month graph of a G/L account is available on-screen through the Company Control program.

### Upgrading from Bookkeeper I to II

This will be of interest to only a few users, namely, those who are upgrading from an MD-3 to a hard disk Micro Decision and wish to continue using the same data files with their new copy of Quest.

- o Load Quest onto the hard disk as described above.
- o Install the new Quest as described, but be especially careful to enter the company name EXACTLY as you entered it when installing Bookkeeper I on the MD-3. Do NOT return to the menus. You should have "10A>" on your screen when the installation is finished.
- o Insert your Bookkeeper I Data Diskette (THIS MUST BE THE ONE THAT CONTAINS YOUR CURRENT LIVE DATA!) into the floppy drive and type this command, followed by a RETURN:

**pip A:=B:kapv.\*[g0 v]**

Repeat the command five more times. But instead of kapv, substitute kglm, kqlt, krem, kret, and kctl.

- o When all of the appropriate files have been copied, type:

**kqub**

- o When you run your new Bookkeeper II, follow standard customer maintenance methods (using the Sales Posting and Journal program) to add addresses for your existing customers.

### Whew!

That's a lot of information to absorb in one session. But think of it: you've travelled every highway and one-lane dirt road that the Co-Pilot Menu System covers.

A word of encouragement is in order. When you begin studying the use of NewWord, Quest, and the rest, you'll inevitably become frustrated and confused for a while. There are dozens of keystrokes to learn; many unforgivingly precise procedures; and the manuals can be tough.

Take heart. That phase lasts a couple of weeks at most. Then you start getting confident, even cocky. And so you've arrived: a computer-user; a Morrowmaniac; a Citizen Of The Twenty-First Century.

And maybe the first one on your block with a hard disk, to boot.

## CHAPTER 3

### ----- ABOUT THE PROGRAMS IN USER 0

User number 0 of your hard disk holds a vast library of utilities, application programs, and other files. If you'd like to see its directory, escape to CP/M from the Co-Pilot Main Menu and type:

**dir [full]**

The files are listed in no particular order, and they're not grouped in any significant way. (Type **pilot go** to get back to the menu.)

Many of these files are standard CP/M utilities that are used mainly by programmers. They are documented in your set of CP/M manuals, and we won't discuss them in this chapter.

The second category of files are your application programs. NewWord, for example, has five files devoted to it: NWU.COM is the uninstalled main NewWord program; NW.COM is its installed version; NW.OVR has additional pieces of the program; NWMSG.S.OVR holds all of the messages that NewWord puts on your screen; and NWINSTALL.COM is the NewWord installation program. We won't be discussing these either, since these programs have their own manuals.

Beyond your CP/M and application programs, there is a handful of other special-purpose programs developed by Morrow for your convenience. This chapter focuses on those programs. They're described briefly below. After that we'll look at them in more detail.

- BACKUP.COM - Duplicates floppies by copying them into a temporary hard disk file, and writing them back out.
- BNKBIOS3.MAC - BIOS source file, for programmers only. Discussion includes linker BIOS.SUB.
- COPYSYS.COM - Copies part of the CP/M operating system onto the "system tracks" of the hard disk or a floppy. Discussion includes CPM3.SYS and SYSLDR.COM.

- CPM2.COM - Makes the Micro Decision operate in a simulated CP/M 2.2 mode, for running programs that are not compatible with the normal CP/M 3.0.
- CPM3.COM - Returns the Micro Decision to CP/M 3.0 after using CPM2.COM above.
- FOREIGN.COM - Allows you to read and write data on diskettes of certain non-Morrow formats, as well as running programs from and copying such foreign diskettes.
- FORMAT.COM - Normally formats floppy disks, but can format your hard disk too if necessary.
- HDL.COM - With associated files HDBOOT.COM and HDPIP.COM, restores the hard disk from the distribution diskettes if it fails its VERIFILE test.
- IMS.COM - Simulates keyboard input by processing whatever follows it (commands, presumably) and telling CP/M to look for input in the IMS buffer instead of the console buffer.
- INIT.COM - Finds out what kind of terminal you're using, helping to install your software easily. Not used if you have an MDT-60 or MT-70 terminal.
- KEY.COM - Loads function key definitions into memory. Used only with MDT-60/MT-70.
- PARK.COM - Moves the hard disk head to a safe place for turning off the computer.
- PILOT.COM - Interprets PILOT programs like the Co-Pilot Menu System.
- PROFILE.SUB - A sequence of routine commands that the Micro Decision executes automatically when you turn it on or reset.
- SETUP.COM - Controls the baud rates at which the Micro Decision talks to your terminal, modem, and serial printer; also sets printer/modem protocol, and selects serial or parallel.

VERIFILE.COM - Makes sure your hard disk survived shipment to its destination.

Now we'll look more closely at these utilities, in the order of their importance to the average user. When you see "CP/M prompt," this refers to the "A>" that you see when you escape from the menu system.

### PARK.COM

PARK is available on the Co-Pilot Main Menu, but you can also run it from the CP/M prompt by typing "park". This is an extremely important program for the safety of your hard disk. It moves the disk's read/write heads to the parking area of the disk, where they can't damage data by knocking against the disk or making an accidental write signal when the power is turned off.

NOTE: You should run PARK every time you turn your computer off! If you want to move the computer and it's off already, and you're not sure whether you parked the heads, turn it back on and run PARK just to be sure.

### FORMAT.COM

FORMAT appears in the menus twice, in one form or another: on the Utility Menu, and on the Backfield Options Menu. When you run it this way, both of its options are automatically specified.

NOTE: Formatting a disk erases everything on the disk. NEVER format your hard disk unless it's hopelessly damaged, and then only after you've backed up what you can onto floppies. You can recycle old diskettes by reformatting them. This is preferable to erasing them with ERA because FORMAT verifies that the magnetic material is still in good shape.

When you run FORMAT from the CP/M prompt, you have to tell it which drive has the disk to be formatted, and whether it should be formatted as single or double-sided. If you specify drive A: (the hard disk), you get a much-justified warning about the dangers of reformatting the hard disk. So it's nigh impossible to reformat the hard disk by accident.



In the normal case of formatting a floppy, the command to enter at the CP/M prompt is:

**format b d**

In other words, format the diskette in drive B as double-sided. The only time you'd format a single-sided diskette is if you wanted to use it on an MD-2 or older MD-1 model.

### KEY.COM

If you have an MDT-60 or MT-70 terminal, you can program your function keys to do just about anything you want. For example, you can program F7 to mean "save the file" under NewWord and "zap the spreadsheet" when running SuperCalc. The meanings for the function keys are kept in files with the last name ".key", like nw.key for NewWord.

The role of KEY.COM is to load the key file into memory, and then run the associated program. The Co-Pilot menus take care of this automatically if you have an MDT-60 or MT-70. So for example, to run NewWord with function keys, the command is no longer simply "nw", but is now "key nw." With this command, KEY.COM will expect to find a key file named NW.KEY.

Morrow has preprogrammed three key files: a default file, a NewWord file, and a SuperCalc file. You are free to change the key meanings as you see fit. See Appendix B for complete details on using KEY.COM.

### SETUP.COM

You won't need to run SETUP often. In fact, you may never need it, if your system matches SETUP's default values and you don't change your hardware.

SETUP determines a number of things about how the Micro Decision communicates with its peripherals. It comes from the factory with these assumptions built-in, and these optional changes:

|                                     | <u>Initial value</u>   | <u>Available options</u>            |
|-------------------------------------|------------------------|-------------------------------------|
| Terminal baud rate                  | 9600                   | 110 - 19200                         |
| Printer connection<br>(LST: device) | CENTRONICS<br>PARALLEL | PRINTER / MODEM<br>(serial)         |
| Printer/modem port<br>baud rate     | 1200                   | 110 - 19200                         |
| Printer/modem port<br>protocol      | XON/XOFF               | HARDWARE HAND-<br>SHAKING ON PIN 20 |
| Auxiliary port<br>baud rate         | 9600                   | 110 - 19200                         |
| Auxiliary port<br>protocol          | XON/XOFF               | HARDWARE                            |

Thus if your terminal can be set to 9600 baud (almost certain), and you have a parallel printer, you don't need SETUP. If you have a serial printer, you will need to run SETUP before you can print anything. Appendix D covers this in excruciating detail.

### PILOT.COM

This program is run whenever your Co-Pilot Menu system is alive. You also have to run PILOT before you can execute any of the commands you may have written in the PILOT language. PILOT.COM is the interpreter that stands between a PILOT-language program and CP/M. This may be a little confusing; some people think that the menu system is PILOT. The menu system is actually a set of programs, the main one being named MICRO.PIL. If you want to run a PILOT program that you've written (named, with inspiration, PROGRAM.PIL), your command would be:

#### PILOT PROGRAM

This tells CP/M to run PILOT.COM, and then PILOT.COM runs PROGRAM.PIL. The ".PIL" ending isn't needed in the command.

Morrow has produced a whole manual dedicated to the PILOT language, so let's move on.

## PROFILE.SUB

You run this "submit" file every time you do a cold boot, that is, every time you turn the computer's power on or press the RESET button. "PROFILE.SUB" is a very significant name. CP/M looks for a file of that name on drive A: in user 0 every time it wakes up, and if it finds one there, it goes ahead and runs whatever commands it finds in the file. If it doesn't find a file of that name, it just displays the system prompt (A>) and waits for your commands.

(Submit files are text files that can be generated with any text editor, such as NewWord. They consist of a sequence of normal CP/M commands. Thus they let you do a whole string of things with a single SUBMIT command. See the CP/M User's Guide for more on SUBMIT.)

Your Micro Decision comes from the factory with a PROFILE.SUB file containing:

```
setdef *,a:[order=(com,sub)]
pilot go
```

This SETDEF command establishes the "search path" that CP/M follows when you type a command. Suppose you type "NW" at the CP/M prompt. This line tells CP/M to look first in the current drive (symbolized by \*) and then on drive A:, if different, for a file called NW.COM or NW.SUB - and then run it.

The second line says "run the PILOT program GO.PIL." GO.PIL is a little program that in turn starts up your menu system. Thus the way to disable your menus is to erase this line from PROFILE.SUB.

Editing PROFILE.SUB is an interesting way to customize your Micro Decision's start-up behavior. For example, you could have it display a "Good Morning" message or better yet, "Don't forget to backup your files." However, unless you prefer a different search path, you should leave the SETDEF line alone.

You can use PROFILE.SUB to create a system that is dedicated to a particular application. For example, to set the Micro Decision up to run NewWord only, use these as your second and third lines:

```
nw
submit profile
```

NewWord will run automatically; when you exit from NewWord, the whole thing starts over. Use this sort of loop with caution - when we tried this out, the only way we could get out of it was to erase these lines from PROFILE.SUB with NewWord after it had restarted for the umpteenth time. (Hint: you can interrupt the processing of the file by repeatedly pressing CTRL-C while it's stepping from one operation to the next.)

### BACKUP.COM

BACKUP is listed on the Backfield menu. You use it to duplicate diskettes. The "source" diskette can be any Micro Decision diskette. The "destination" diskette must have been formatted, but need not be empty. However, anything on it will be replaced by the contents of the source diskette.

BACKUP copies the source diskette track-by-track into a temporary file BACKUP.DSK in user 0 of the hard disk. Then it dumps this back out to the destination diskette and erases the temporary file. That's how you can duplicate diskettes with only one floppy drive.

You have the option of making multiple copies before BACKUP erases BACKUP.DSK, but you need to have all the formatted destination diskettes ready at hand.

Why, you may wonder, should you want to duplicate diskettes in the first place, when the diskettes are probably backups of the hard disk? For one thing, you may want to send copies of the fantastic new program you've written to all your friends with Micro Decisions. Or more likely, if you have a particularly valuable file, like Accounts Receivable, you may wish to have two backups of it: one for the office, one in a vault.

Since BACKUP copies track-by-track rather than file-by-file, a source diskette with CP/M in its system tracks will produce a bootable copy.

### CPM2.COM, CPM3.COM, and CPM2.RSX

All Morrow hard-disk Micro Decisions (MD-5, MD-11, MD-16, and MD-34) use the CP/M 3.0 operating system, also known as CP/M Plus. This is an enhanced version of the more common CP/M version 2.2, which Morrow continues to use with its floppy-disk Micro Decisions.

While CP/M 3.0 is much nicer than 2.2 in many respects, there is a down side: Some business programs designed for CP/M 2.2 and older CP/M versions are not compatible with CP/M 3.0. If you run such software on the hard disk systems, they may not work at all. Or, they may seem to work at first, but there will be strange anomalies in their operation that indicate that something is definitely wrong.

Three such programs that have been brought to our attention are MicroPro's InfoStar and DataStar, and TCS Accounting from TCS Inc. There are likely to be others that we haven't encountered yet.

### Introducing CPM2.COM, CPM3.COM, and CPM2.RSX

- o **CPM2.COM** simulates a CP/M 2.2 environment on the hard-disk systems.
- o **CPM3.COM** returns the system to normal 3.0 operation.
- o **CPM2.RSX** is a special file that can be attached to frequently-used 2.2 programs, eliminating the need to enter either of the two commands above.

### Using CPM2.COM, CPM3.COM, and CPM2.RSX

See Appendix C.

## FOREIGN.COM

This program comes in very handy when you find some wonderful piece of CP/M software that's available in Xerox 820, Osborne, KayPro, or HP-125 (but not Morrow) format. Or if you have an IBM PC at work and you want to do some word processing on your Micro Decision at home, you may be able to edit documents on the same disk with both computers. FOREIGN is further covered on page 4-31.

FOREIGN is run only from the CP/M prompt, so the first step in using it is to escape from the Co-Pilot Main Menu. Then type:

### **foreign**

You'll be asked which drive to use as the foreign drive. You have three choices: B, C and D (A: being the hard disk). B is a good general response, unless you're doing something fancy like PIPping Morrow files from drive B: to a KayPro diskette in virtual drive C: and a Xerox diskette in virtual drive D:. If this concept of letters for more floppies than you've got sounds strange, read about virtual drives on page 6-15.

After specifying the drive, pick the letter of the format you want that drive to process. Put the foreign diskette in the drive, and treat it the same as a Micro Decision diskette.

After using the drive in its foreign mode, turn it back to good ol' Morrow by running FOREIGN again and specifying Morrow format for the same drive. (You don't really have to do this unless you need to read a Morrow floppy; the drive is returned to Morrow mode when you reset or turn off the computer.)

FOREIGN has a few limitations which will probably have changed by the time this is printed. At present, FOREIGN cannot format foreign diskettes. If your friend has an HP-125 and you want to give him a copy of one of your Morrow files (not a copyrighted program, of course), he'll have to format a diskette for you.

Also, FOREIGN has rather strict limitations regarding IBM-PC diskettes. They must be in single-sided CP/M-86 format (not PC-DOS), and you can read and write data on them, but not execute programs from them, since they would be written for a different operating system.

## IMS.COM

Most users will not ever enter this command directly. However, the Co-Pilot menus use it all the time. The function that PILOT uses is not called IMS, though, but rather CPM:, and you can learn about it in the PILOT User's Guide.

IMS stands for In-Memory Submit. Submit files are a string of CP/M commands that are executed one after the other. See PROFILE.SUB above for an example. An in-memory-submit is a submit file that stays entirely in memory instead of being read from disk a line at a time. Here's an example of an IMS command:

```
IMS user 2;nw|show A:
```

The use of vertical lines and semicolons on these command lines is covered in the PILOT User's Guide. What this command does is: (1) log into user 2; (2) run NewWord; (3) when you exit from NewWord, shows how much space is left on Drive A:. You can make very elaborate IMS commands. Some of the ones used by the Co-Pilot menus are so long they run off the right side of the screen!

You can enter IMS commands directly from the keyboard or as part of a regular SUBMIT file.

## INIT.COM

This is a very specialized program that is normally used only once in the life of your system, if at all. It presents a list of popular terminals, and asks you to select yours. Your choice determines two things: which of three general categories your terminal falls into ("Levels I, II, and III") and how the Micro Decision's BIOS will translate generic terminal codes into the ones expected by your particular terminal.

Let's start at the beginning. The primary assumption is: Installing application software is a major hassle. Morrow wants its users not to have to install their software. How, then, to go about this?

Every application program has its own list of terminals that it presents as part of its installation. Maybe yours is there, maybe it's not. However, it's very likely that the Lear Siegler ADM-3A, ADM-31, and SOROC IQ-120 will be there. These three terminals are representative of the varying levels of intelligence being built into terminals these days (although most modern terminals are of the high-intelligence flavor).

Morrow gets around making you install the software that comes with the Micro Decision by categorizing your terminal as Level I (ADM-3A), Level II (SOROC IQ-120), Level III (ADM-31), or Level IV (MDT-60/MT-70).

When you first set up your system, you're asked if you have a Morrow MDT-60 or MT-70 terminal. If not, INIT is run and you pick your terminal. The Micro Decision then installs your software for one of the four terminals listed above, automatically.

When you run your software, the Micro Decision takes care of translating any differences between the "representative" codes and your terminal's real codes. This explains why you're told that you should install any non-Morrow software for one of these three models.

(If you could not find your terminal or a look-alike on INIT's menu, then you default to a Level 0 terminal, and you may need to install some of your Morrow software after all. See page "NWINSTAL - 2" towards the rear of the Correct-It User's Guide. And for non-Morrow software, install by selecting your actual terminal - NOT the generic ones above.)

**NOTE:** The only time you would run INIT on your own is if you want to use a different model of terminal with the Micro Decision after completing the software installation that occurs when you first set up your system. After INIT, you should run MDINST.PIL (type `pilot mdinst`) to re-install the Morrow supplied software automatically for your new terminal.

### COPYSYS.COM (plus SYSLDR.COM and CPM3.SYS)

COPYSYS is a standard CP/M utility, comparable to SYSGEN in earlier versions. We mention it here because there are some details that you should be aware of.



COPYSYS copies a special "system loader" file, normally called SYSLDR.COM, from its random position on a disk to the reserved system tracks of that disk, or a different disk. You do this in order to make a disk bootable, that is, so the computer can wake up from a cold start and groggily find its system information in the special file CPM3.SYS.

The average user has no need for such a program. If your hard disk ever becomes unbootable (for example, if lightning strikes while your disk head happens to be positioned over the hard disk's system tracks), you can boot from your Backfield Working Diskette, and COPYSYS will be performed automatically as part of the full hard disk restoration. Advanced users may want to use COPYSYS after customizing certain details of CP/M.

Beyond the system tracks, there is another file called CPM3.SYS that must be present on the hard disk. It holds the rest of the operating system.

This is all clean and simple if you're "COPYSYS'ing" from one hard disk to another. But this is seldom the case. User 0 contains these files to help handle all variations: SYSLDR.COM, SYSLDRF.COM, CPM3.SYS, and CPM3F.SYS. All files mentioned so far are also on the CP/M Distribution Diskette #1 as well as the hard disk.

To make a bootable diskette, log onto the hard disk and type:

```
COPYSYS SYSLDRF.COM
...(Destination drive?) B: (Note the colon)
...(Any more?) N
PIP B:=CPM3F.SYS[R] (R flag for system files)
```

Now you can boot from this diskette, but it must be in the drive with the latch shut when you power up or reset the computer.

To restore the system tracks of the hard disk from the CP/M Distribution Diskette #1, boot from that diskette as described in the last paragraph. (Be sure to tell the automatic load program HDL.COM to STOP rather than continue.) Then type:

```
COPYSYS SYSLDR.COM (no "F" this time)
...(Destination drive?) B:
...(Any more?) N
PIP B:=CPM3.SYS[R] (again, no "F")
```

This may be worth trying as the first step in restoring an unbootable hard disk. It's possible that any damage is isolated to the system tracks of the hard disk. Then a full restore is unnecessary; only the COPY-SYS is needed.

#### HDL.COM, HDBOOT.COM, HDPIP.COM

HDL (Hard Disk Load) is a utility that copies all of your Distribution Diskettes onto the hard disk, in case it was damaged in transit. It is the same program that's used at the factory to prepare your hard disk for use. HDL is run automatically if you go through the procedure for repairing a hard disk that fails VERIFILE (see below).

What you see when HDL is running (should you ever need to run it) are directions like "Insert your NewWord Distribution Diskette and press C to continue." Not particularly complex.

You would NOT use HDL to rebuild a damaged hard disk that's had any data added to it. It's only for brand-new machines. To restore files to a damaged hard disk that's been in use, boot from your Backfield Working Diskette.

NOTE: Upon proofreading, the preceding paragraphs make it sound like your hard disk is a supremely delicate mechanism, bordering upon frail. Actually such devices are quite rugged, and seldom give any trouble. But the cost of that statistically remote failure can be devastating, if you have not made any backups. We stress the need for routine backups only because it seems to be a hard habit for some people to adopt. We hereby disavow any and all responsibility for the suffering incurred by those too lax to heed this warning.

HDBOOT and HDPIP are auxiliary programs that are only used by HDL. HDPIP copies the files from the Distribution Diskettes onto the hard disk. It differs from the normal PIP by having a special error-checking function. HDBOOT causes a fresh start after the hard disk has been reloaded. It assigns the hard disk to be drive A, while skipping the "Do you want to boot from the floppy?" prompt.

#### BNKBIOS3.MAC and BIOS.SUB

These are used by programmers to modify CP/M for a custom application. Average users please ignore. BNKBIOS3.MAC is the banked BIOS source file. Upon modification, it must be assembled by m80, not mac, which is supplied with the Micro Decision. You can then run BIOS.SUB for linking. BIOS.SUB runs NewWord to allow you to set up your disk drives. The rest is automatic. The result is a new CPM3.SYS or CPM3F.SYS.

#### VERIFILE.COM

One of the very first things your Micro Decision does (or did) when you set it up is run VERIFILE to assess the condition of the data that was prerecorded on the hard disk. The program checks to see that every allocated sector is still readable. The outcome of VERIFILE decides whether you need to run HDL.

Under normal circumstances, after this initial run you'll have no use for VERIFILE. However, suppose you use your Micro Decision for a couple of years and then move to Walla Walla. You can run VERIFILE upon your arrival and see how badly the movers mistreated your treasured computer. (You did park the heads and pack it in its original container, didn't you?)

-- (\*) --

In conclusion, if you don't get anything else out of this chapter, at least remember to PARK YOUR HEADS!

Also, when a section doesn't tell you exactly what to type for running the program directly from CP/M, that's because the program name is all you need to type. If it ends in .COM, you don't even need to type that part. For example, to run BACKUP.COM from the A> prompt, simply type "backup" and press RETURN. Once you get used to its pickyness, CP/M isn't so bad after all.



## CHAPTER 4

### MICRO DECISION QUESTIONS AND ANSWERS

#### ----- G E N E R A L -----

Sometimes you warn me NOT to press the RESET button, and other times you tell me I MUST do it. What gives?

There are times when pressing RESET (the little square button on the lower right of the Micro Decision's front panel) can mean disaster. But most of the time, it's perfectly harmless. It just makes the Micro Decision start over. If you haven't disabled the Co-Pilot Menus, pressing RESET takes you to the Main Menu.

In general, you should avoid "resetting" whenever a file is open for writing, that is, when you're making changes to a file. When you're editing a letter with NewWord, or typing data into a spreadsheet with SuperCalc, there's a file opened for writing.

On the other hand, a file can be opened for reading only. When you're printing the letter, it's opened for reading only and resetting will do no more harm than stopping the printout.

Here are a couple of rules:

- o If you've escaped to CP/M (the A> or similar prompt is onscreen), it's OK to reset. This will clear any temporary changes you might have made with the SETUP program, and sets any foreign drives you've assigned back to Morrow format.
- o If the Co-Pilot Menus are onscreen, it's OK to reset. They'll stop whatever they were doing, however.
- o If you're printing something, it's generally alright to reset. The printing stops and must be started over again.
- o If you're entering data into a file with one of your programs, you should NOT reset until you've saved the file.

Now, why would you want to reset in the first place? There are several reasons: The system has locked up and doesn't respond to any keys; you've gotten hopelessly lost in the nether depths of a program and can't find your way out; you keep getting errors of some kind and can't figure out how to get around them; or you just wanted to start a program and abort it in its early stages, for whatever reason.

-- (\*) --

### What are the restrictions on any file names I make up?

You'll be creating new files all the time, especially with NewWord, and you have to come up with names that balance the need for being descriptive against CP/M's need to keep them short.

Briefly, a file name has three parts, of which only the first is required:

- o The first name, which can be from 1 to 8 characters
- o A period
- o The last name, which can have up to three characters

If a last name is used, then the period must separate it from the first name. The last name is sometimes called the "file type" or "extension". By characters, we mean letters and numbers, and a few punctuation marks.

These are all valid file names:

|        |            |       |          |
|--------|------------|-------|----------|
| 5      | F          | 5F    | 5F.DDD   |
| LETTER | LETTER.684 | LET.M | LETTOMOM |
| D.ATA  | DA.TA      | DAT.A | DATA.    |

These are NOT acceptable:

|               |                                     |
|---------------|-------------------------------------|
| MYGREATNO.VEL | (too many characters before period) |
| MYGREATN.OVEL | (too many characters after period)  |
| 1/31/84       | (slash character not permitted)     |

File names must be distinguishable from each other. No two files on the same disk, with the same user number, can have exactly the same name. At least one character must be different. However, since your hard disk has 16 user numbers, you could conceivably have 16 files on it with exactly the same names.

You should try to make your file names as descriptive of the file's contents as possible. For example, if you type many memos, you could construct the file name from the name of the person you're writing to, and the date, as in HOWARD.313.

The characters that you can't use in file names are:

< > = , ! | \* ? & / \$ [ ] ( ) . ; : \ + -

This implies that a few special characters are okay, as in NANCY'S.FIL. Also note that certain last names have special meaning to CP/M. Most importantly, .COM and .SUB go at the end of program file names. See also pp. 2-1 - 2-3 in the CP/M Plus User's Guide.

-- (\*) --

**Would you please explain this business of disk drive letters?**

CP/M (and operating systems in general) keep track of which disk drive is which by assigning a letter to each one. In very large systems, there may be as many as 16 drives, A through P.

The Micro Decision has only two drives: "A", the hard disk, and "B", the floppy disk. Under unusual circumstances, these letter assignments can be reversed. It can also pretend to have two extra "virtual" floppy drives, "C" and "D".

CP/M allows you to have completely different files with the same name, so long as they're on different disk drives. If you tell CP/M to run a certain program file, and there are two or three of them out there on different disks, how does it know which one you mean? Because you tell it what drive it's on, in the format X:FILENAME, where "X" is the actual drive letter.

To display ADDRESS on floppy drive B, you'd enter TYPE B:ADDRESS. If you leave off the B:, you'll probably get a "File not found" error message.



Typing the disk drive letter can get a little tedious, if you're always using the same disk drive. This is frequently the case with your Micro Decision, where you're almost always dealing with the hard disk, or drive "A". So CP/M uses what's called a "logged drive". Whenever you refer to a file, unless you include a drive letter, CP/M assumes it's on the logged drive. The logged drive is sometimes called the current or default drive.

The Logged Drive = Current Drive = Default Drive

You're always "logged onto" a certain disk drive. That drive will be where CP/M looks for files unless you say otherwise by typing a drive letter with a file name.

Nearly always you will be logged onto drive A, your hard disk, since most or all of your program and data files are there. CP/M automatically logs you onto drive A when you boot the Micro Decision by turning it on or pressing the RESET button.

When you're working with CP/M directly (as opposed to through the menus), you'll see a prompt at the left side of the screen, like "A>" or maybe "15B>".

**Ah yes, the system prompt. You mean the little "A>" on my screen when I'm not using the menus. What's it all about?**

The system prompt means CP/M is ready for a command. The command could be a CP/M housekeeping chore like DIR or PIP. Or it could be the command that starts a business program, like NW for NewWord. You type the command and hit the Return key to begin its execution.

The letter and number in the prompt are telling you which drive and user number you're logged onto. "A>" means drive A, user 0; "15B>" means drive B, user 15. (If there's no number, only a letter, it means user number 0. You won't see "0A>".) Ignore user number for now -- it's sort of a subdivision of the disk drive.

The choice of what drive and user number you're logged onto is entirely under your control. You start at drive A, user 0 when you boot the Micro Decision or exit from the menus. Thus "A>" is probably familiar to you. But you can readily change that to 2A> or 11B> or 7D> with commands in the format "#X:". Type the desired user number, then drive letter, a colon, and hit the Return key.

So what does it mean to be logged onto a disk? It means that if you tell CP/M to run a program or process a data file without telling it which disk to look on, it will look on the current drive, in the current user number. If the program isn't there, you either need to tell CP/M where to look explicitly, or else log onto the correct disk and user number. (There are some exceptions to this rule that go beyond this discussion. See "SETDEF" in the CP/M User's Guide.)

#### **Why would I want to change drive letters or user numbers?**

You'd only do so if you've gotten used to running your software directly from CP/M, outside of the menus. Co-Pilot automatically handles the details of logging into the right places for you when you run programs through it.

Suppose your prompt reads "A>", and you want to run a program called "test" on drive B. Most of the time you can do either of two things: 1) run the program with the command `B:test`, or 2) log onto drive B: first with `B:` and `RETURN`. The prompt changes to "B>". Then type `test`.

You should also read "How do I run my programs directly from CP/M?" on page 4-21.

When you disable the Co-Pilot menus or temporarily escape from them, you always land in user 0 of drive A. The prompt says "A>". This is the normal place to start, since all of your Morrow-supplied software is right there.

However, maybe you want to run a program on a floppy in drive B. As above, with some programs you can type `"B:PROGRAM"` at the `A>` prompt and that will work. But other programs (NewWord for example) won't let you do that. The prompt has to show their proper drive letter before you type the command. So you'd log onto the right drive first by typing `X:` and `RETURN`, where X is the letter of the drive that holds the program.

#### **An attempt to pull all of this together:**

Let's say you want to copy a file from one floppy disk to another with the PIP command. There are three disks involved: the hard disk (drive A) which holds the PIP.COM program, one floppy (drive B) that holds the original file, and another floppy (virtual drive C) that will hold the copy.

Assuming you haven't changed user numbers away from 0 (no number is shown in the A> or B> prompt), this command is guaranteed to work:

**A:PIP C:COPYFILE=B:ORIGFILE**

"COPYFILE" and "ORIGFILE" are being used here only as sample file names.

You've specified the drive letter for every one of the three files involved. There's no room for mistakes on CP/M's part. However, you could have skipped one of the letters and colons, because one of these is sure to be the same as the currently logged drive.

So suppose you're logged onto drive A (the prompt says "A>"). You could shorten the command to:

**PIP C:COPYFILE=B:ORIGFILE**

CP/M thus assumes that drive A holds the PIP.COM program.

At the other extreme, suppose you're making a copy of a file that's on drive A already, and the copy will also go on drive A. If your prompt is A>, your command would be:

**PIP COPYFILE=ORIGFILE**

If you've logged onto a different drive, you'd either have to put "A:" in front of all three file names, or more simply, log back onto drive A first with A:.

### User Numbers

As mentioned, user numbers are subdivisions of the hard disk. We covered them a little on page 2-4. To learn more about their use, take the "Fundamental Training in CP/M" option on the Co-Pilot Utility Menu. We'd just be repeating ourselves to put that information here.

User numbers are like drive letters, in that you're always logged into one (from 0 to 15). When you refer to a file in a command, you usually need to specify its user number, or log into that user number, if it isn't the same as the current one shown in the prompt (1A>, for example).

The main thing to notice is that certain files can be put in user 0 and given the "system" attribute. Then they can be accessed from any other user number without special handling. All of your Micro Decision programs have been set this way. Therefore when you run NewWord through the menus and pick file drawer #1, you are dealing with documents in user 1, and NewWord "system" program files in user 0.

-- (\*) --

**Sometimes when I turn my Micro Decision on, or press the RESET button, I see "Do you want to boot from the floppy?" When would I say Yes, and why don't I see this every time?**

The only time you see this question when you "power up" or reset is if there is a floppy disk in the drive with the latch closed. Otherwise the Micro Decision automatically proceeds to boot from the hard disk. (As we have seen, "booting" is when the Micro Decision copies special CP/M information from a disk into memory.)

The hard disk always has this information on it, unless it is damaged. Only a couple of specially-prepared floppy disks have this information, so you can't boot from just any floppy disk.

If and when you see "Do you want to boot from the floppy?", just answer N for No. The only time you'd answer Y is if you keep getting errors after you power up (or reset) but before the Co-Pilot menus or A> prompt appears. This means there is some problem with the hard disk, or with the special boot information on the hard disk. You could then boot from one of the special floppies and continue working. See below.

#### Disk drive letters and booting from the floppy

As we saw in the section on drive letters, if a file is on a floppy, you'll be dealing with the B drive; if it's on the hard disk, it's the A drive. But these designations will be the other way around if you boot from the floppy. CP/M always calls whichever disk has the boot information the A drive. So if you boot from the floppy, it is now the A drive and the hard disk is the B drive.

### Which diskettes can you boot from?

When we say "the" floppy, we're referring to either the **CP/M Distribution Diskette #1** that came with the Micro Decision, or the **Backfield Working Diskette** you made when first setting up the system. You can prepare other floppies to be boot disks, but we doubt you ever will. It takes a special procedure to prepare a floppy for bootability. See "COPYSYS" in Chapter 3.

### When to Boot From the Floppy

Almost never. In general, you'd boot from the floppy only when you can't boot from the hard disk due to some malfunction.

### Booting From CP/M Distribution Diskette #1

The only cases when you should boot from the CP/M Distribution Diskette #1 is (1) if and when the hard disk fails its VERIFILE test, (2) if you start your system in the normal way, any you get repeated error messages when the Micro Decision attempts to boot itself from the hard disk, and (3) your hard disk is very damaged and you have not used Backfield to make backups.

#### **1. VERIFILE fails**

VERIFILE is run automatically when you first set up the computer. It determines whether the information pre-recorded onto your hard disk was damaged in shipping. If the test fails, you are told to boot from CP/M Diskette #1. A program called HDL proceeds to lead you through copying all of your Distribution Diskettes (NewWord, SuperCalc, etc.) back onto the hard disk. Note that this is appropriate for brand new systems only. HDL reformats the hard disk, erasing everything from it. So if you've used the system and added data to the hard disk, don't let HDL continue. We'll tell you how to abort HDL in the next section.

#### **2. Unbootable hard disk**

This means the Micro Decision locks up or gives error messages when you turn it on. If the error message gives you the "Abort, Retry, Ignore" option, retry three times by pressing R. From here on we're assuming that retrying didn't help.

An unbootable hard disk has been damaged. Perhaps it was jolted too hard, or there was a badly-timed power glitch, or maybe you forgot to PARK it. The damage may be confined to the boot information, or it may be far more extensive.

Here's the first thing to try, before taking the system to the repair shop:

We assume the system is already turned on. Don't turn it off yet.

1. Insert your CP/M Distribution Diskette #1 and close the latch. Press the reset button on the Micro Decision front panel.
2. When you see "Do you want to boot from the floppy?", respond Y. The next screen (provided by the HDL program) warns you that your hard disk will be reformatted if you continue. Tell this program to STOP by pressing S. The A> appears.
3. Enter this command:

**COPYSYS SYSLDR.COM B:**

When the A> prompt returns, press the RESET button and see if you can now boot from the hard disk. If not, proceed with the process of restoring your whole hard disk. For most people, this begins with booting from their Backfield Working Disk. See below.

### **3. You've been using PIP instead of Backfield to make backups**

This would indicate that you possess some degree of computer literacy. A full restore consists of booting from CP/M Distribution Disk #1, and continuing with the HDL program, which pips everything from your distribution disks back onto the hard disk. Since the hard disk is reformatted, your accumulated data and non-Morrow software will not be present at the end of HDL. We assume that all of this data is on floppies and that you will pip it back onto the hard disk yourself. Any changes you've made with SETUP will have to be repeated. Likewise, customizations of your software (like re-installing NewWord with NWINSTAL.COM) will also have to be repeated.

If more than the system area is damaged on the hard disk

The procedure above will usually get you to a point where you can boot from the hard disk, but if there is extensive damage, there is no guarantee that much else will be intact. Things are especially nasty if the directory area of the disk has been "trashed". You can gauge the problem by reading the directory; if it looks okay, try using the Micro Decision in the normal way. Log onto drive B (the hard disk, since drive A is the floppy when you boot from it), by typing "B:" and Return. Use DIR [FULL] to look at the directory. Try running NewWord with NW.

There are degrees of damage. Perhaps only one file is damaged. Let's say you try to run NewWord. As it begins, you see "Data not found error reading drive A: Abort, Retry, Ignore?" Press A to abort. This will tell you the file that had the problem in it; in this case, NW.OVR. You get your NewWord Distribution Disk, PIP the file onto the hard disk in user 0, and set it to system status with SET NW.OVR [SYS]. Problem solved.

If you can't read the hard disk's directory, or if you get frequent and persistent error messages like "sector not found" or "data not found", you'll need to reformat and restore the whole hard disk. The success of this effort depends entirely on you having made routine backups with Backfield or PIP.

Regardless of the hard disk's condition, we recommend running PARK from the floppy before shutting down the Micro Decision. Log onto the floppy with "A:" and Return, then enter "PARK" and Return.

If you've been using PIP instead of Backfield, we assume you know enough to make the restoration yourself. Start by booting from CP/M Distribution Diskette #1, and follow through the HDL program as it copies all your other master disks back to the hard disk. You'll have to recover your data files individually.

Booting From The Backfield Working Disk:  
Normal Full Hard Disk Restoration

In the more probable case that you've been using Backfield for backups instead of PIP, begin by booting from the Backfield Working Disk that you created when first setting up the system. It leads you through restoring the hard disk to its condition at the time of

the last full backup. You can then boot from the hard disk and use Co-Pilot's Backfield Options Menu for restoring any files you backed up with the incremental option "Backup only those files that have changed."

**NOTE:** The Backfield Working Disk is NOT the same as the Backfield Distribution Disk. The latter came with your system and has a Morrow label on it. The Working Disk was made by you when you first set up the system. It should have a label on it that you wrote yourself.

Both of these disks are distinct from the backup disks that contain the information from your hard disk. See pages A-1 - A-3 if you're still having trouble sorting through all the Backfield disks.

-- (\*) --

**How do I program my terminal's function keys?**

See Appendix B.

-- (\*) --

**What do I do if I buy a new printer or terminal after I've installed all of my programs?**

#### New Printers

Let's begin by listing a few possibilities:

- o You had a serial printer, now you have a parallel
- o You had a parallel printer, now you have a serial
- o You had and still have a serial printer
- o You had and still have a parallel printer

If either of the latter two is true, your life will be easier.



In any of these cases, you should run the program `nwinstal` as described under "How do I change NewWord's help level?" (page 4-25). Instead of changing the help level, though, you'll be changing the printer selection. Select "Printers" from `nwinstal`'s main menu instead of "NewWord related items."

If you don't see your new printer or a lookalike on `nwinstal`'s printer list, try Draft Printer.

Now then. For those of you who substituted serial for parallel or vice versa:

1. Escape from the menus by typing the `ESC` key at the Co-Pilot Main Menu.
2. At the `A>`, type `setup` and press `RETURN`.
3. Turn to "Setting Up Serial Printers" on page 1-17. Read the description of setup. The `B` key controls whether you have a serial or parallel printer. Set it accordingly. Also note the other details about serial printers, if this is the type you'll be using.

That's it!

### New Terminals

You should try the new terminal first without changing anything. It may work just fine. Be sure it's set up correctly, as described on page 1-9. We hope, incidentally, that you bought one of the terminals listed on page 1-2.

If you're upgrading to a fancier terminal, or if the terminal isn't working right even though it's set up correctly, do this:

1. Escape from the menu system by pressing the `ESC` key at the Co-Pilot Main Menu.
2. At the `A>`, type `init` and press `RETURN`. Select your new terminal, or one that acts just like it, from the list that appears. If your terminal or one it emulates isn't there, select "None of the above" and read what the screen says in response carefully.

3. When A> reappears, press the RESET button. See how your terminal performs. If you're still having problems, ask your dealer for help.
4. Get back out of the menus as in step 1. At A>, type `set *.com [rw]` and press RETURN. A list of files rolls up the screen. You are setting them to "read-write status" to enable the next command to work properly.
5. When the A> returns, type `pilot mdinst` and press RETURN. This is the same installation program that you used when you first set up the Micro Decision. Some parts of it won't work right, but it will keep going. The part that's of interest is NewWord installation; NewWord will automatically be reinstalled for your new terminal. Be aware that if you've further modified NewWord (like changing the Help Level -- page 4-25) you'll have to repeat those modifications.

----- C O - P I L O T   M E N U S -----

**Can I add other programs to the Co-Pilot menus?**

Yes, it can be done, but it's not recommended for the faint-hearted or the complete novice. You need to become familiar with the Pilot programming language as described in the Pilot User's Guide. Pilot is a very easy language to learn.

The Co-Pilot menus are a relatively sophisticated Pilot program. Nonetheless, they are easily deciphered once the nature of Pilot is understood. We will not attempt to give details of adding a program to the menus here, since it would take a chapter all its own. However, we will give you a few tips:

1. The module you are interested in is MICRO.PIL. It is a system file in user 0 of your hard disk.
2. Make a copy of MICRO.PIL with a different name and use it as a work file.
3. There will be two main steps: adding the program's name and selection number to the menu display, and creating a new subroutine that actually runs the program.
4. The question below about translating the menus will probably be helpful.

Good luck!

-- (\*) --

**How can I disable the Co-Pilot Menus so my Micro Decision goes right to the A> prompt when I boot?**

This involves changing a special file named PROFILE.SUB in user number 0 of your hard disk. This file consists of nothing but CP/M commands that are executed when the system wakes up. See PROFILE.SUB in Chapter 3, "About the Files in User 0."

Here's the easy way:

1. Start NewWord either through the menus or straight from CP/M.
2. At the Opening Menu, select L to change the logged drive. Change the drive to **0A** (that's zero-A).
3. Type **N** to open a non-document file. Give **PROFILE-.SUB** as the file name to edit.
4. In the file, which is very short, put your cursor on the line that reads "pilot go". Erase that line with **CTRL-Y**.
5. Save **PROFILE.SUB** with **CTRL-K-X**.
6. Press the **RESET** button. This time the menus will not appear.

You can start the menus under these circumstances any time by typing **pilot go** at the **A>** prompt. To restore them permanently, edit **PROFILE.SUB** again, and add the **pilot go** line back into it.

-- (\*) --

#### **How can I translate the Co-Pilot menus into another language? (i.e., a non-English language)**

This is a fairly simple process, but be aware that you'll be editing a program, not just sentences. If you follow the directions carefully, there should be no problems. But it is possible to throw the program out of whack by changing things you're not supposed to. Just make sure you use this method, which leaves the original program intact - you'll be working on a copy.

1. Escape from the menus by pressing the **ESC** key at the Co-Pilot Main Menu. When you see "**A>**", type **nw** and press **RETURN** to start NewWord.
2. At the Opening Menu, type **N** to open a non-document file. Give **MIC.PIL** as its name. Verify that you want to create a new file with **Y**.

3. As the very first step after opening the new file, type **CTRL-K-R** (the same as **~kr**) and give **MICRO.PIL** as the name of the file to insert.
4. Now you have a fresh copy of the menu system that you can change as you please without damaging the original **MICRO.PIL**. The lines you are looking for begin with **T:**, **TY:**, **TN:**, and **TNR:**

NOTE: DON'T CHANGE ANY LINES EXCEPT THESE "T" LINES.

If one of these **TYPE** command lines contains a variable, like **#USER** or **\$FILENAME**, DON'T translate the variable name. Work around it.

5. Save the file after working for a while with **CTRL-K-X** (**~kx**). Test it by typing at the **A>** prompt:

```
set mic.pil [sys] (press RETURN after each line)
pilot mic
```

6. If it seems to be alright, start **NewWord** again, and choose **N** to open the non-document **MIC.PIL** - not **MICRO.PIL**. Continue translating and testing. If at some point the program ceases to work right, you can try to fix it according to the **PILOT** manual. You can step back to the previous version by erasing the defective **MIC.PIL** and renaming **MIC.BAK** to **MIC.PIL**. As a last resort, you may be forced to erase **MIC.PIL** and start over at step 1.
7. When you're satisfied that the program and translations, enter these commands at **A>**:

```
ren micro.old=mic.pil
ren mic.pil=mic.pil
pilot go
```

These commands make the original file inactive, replacing it with the translated version. If for some reason you want to switch back to the original, just re-enter the **ren** (rename) commands (the bottom one **FIRST**, this time) also reversing the names on either side of the equal signs.

These steps take care of the **Main Menu** and **Utility menu**. To translate the **CP/M Tutorial**, use the same procedure, but name your new non-document **TUT.PIL** in step 2, and insert **TUTORIAL.PIL** in step 3. The bold command lines will also change accordingly.

To translate the installation program, the new non-document should be named **MDI.PIL** in step 2. The file to insert in step 3 is **MDINST.PIL**.

The very first congratulatory message that appears when you set up the Micro Decision is in a file called **STARTUP.PIL**. Name your non-document **START.PIL** and insert **STARTUP.PIL**. Be aware that if you want this program to run on a cold start (as if this were the first time the Micro Decision was used), you need to rename **START.PIL** to **INIT.PIL**.

A final note: Some of the Micro Decision's messages (like error messages) come from other sources and are not part of the menu system. You cannot translate these messages without creating a customized ROM and translating **BNKBIOS3.MAC**.

### **What's the best way to learn about CP/M?**

Since nothing beats hands-on experience, you ought to go ahead and break out of the menus with the **ESC** key and try a few things.

But first you might go through the "Fundamental Training in CP/M" option on the Co-Pilot Utility Menu. This teaches you the most basic things you should know.

Then you might try the exercises in Chapter 2 in the section on the Utility Menu. These will give you a taste for entering commands without having to make them up yourself.

Finally, dig into the CP/M Plus User's Guide. This is one of the five-volume set that came with the Micro Decision. There's no substitute for experimenting. There are a number of other books about CP/M in bookstores, with varying degrees of quality. We suggest browsing through them to find the one that's on your present level. Be sure it discusses CP/M 3.0, not just version 2.2.

-- (\*) --

### **What is the relationship between CP/M and the rest of my software?**

All business or entertainment programs have certain needs in common: They have to know how to find information on the disk, and how to send information to your terminal and printer. Unfortunately, every model of computer is different in these details. It would appear, then, that a programmer would have to produce a new version of his program for every computer on the market. Not a very happy prospect.

However, a compromise has taken shape whereby computer makers design their systems to run a certain operating system (CP/M, MS-DOS, Apple DOS), and programmers design their programs to run "under" one or more of these popular systems. The operating system can be thought of as a gasket that provides off-the-shelf compatibility between software and hardware.

A primary result of this arrangement is that now the programmers are able to leave out large chunks of their programs, trusting that the operating system will be there to handle the details. If you hear someone referring to his "BIOS" and "BDOS", these are the pieces that programmers are able to leave out. The BIOS deals with screens, printers, and modems; BDOS handles the disk drives.

### Booting

When you "boot" the Micro Decision at the start of a session, you are loading CP/M from a disk into memory. CP/M consists of the BIOS and BDOS, plus another piece called CCP, which handles executing commands if you're not using the Co-Pilot menus. Otherwise the menus take the place of CCP.

You have to boot the Micro Decision before you can do anything else with the system. Programs like NewWord won't work -- the Micro Decision can't even read them from the disk until BDOS and BIOS are in memory.

Booting is an automatic process. Usually, all you have to do is to turn the computer on. The only thing that lets you know that booting is occurring is this message on your screen:

```
=====
CP/M V3.0 Loader
Copyright (C) 1982, Digital Research

62K TPA

CP/M Plus - Ver 3.0 Rev 2.0
Copyright 1982, 1983 Digital Research, Inc.
Copyright 1983, 1984 Morrow Designs, Inc.
=====
```

Parenthetically, "62K TPA" tells you how much room is left for your programs in memory after CP/M has been loaded into memory.



If you are using the menus, other messages follow, like "Morrow Designs Pilot" and so forth. Booting is finished and other programs are underway.

### Summary

Software that you buy leaves out a lot of details because there are so many variables in the hardware you might be using. Your operating system, CP/M, fills in these gaps with its major components BIOS and BDOS. Whenever you turn the computer on or press its reset button, CP/M is automatically loaded from the hard disk into RAM. This is called booting.

-- (\*) --

**If all CP/M machines are compatible, then I should be able to buy any CP/M software and run it on my Micro Decision, right?**

Uh, well, yes, sort of. There are a couple of factors that complicate matters.

First, not all CP/M disks are created equal. Even though information is laid out in the same sequence on all CP/M disks, different computer makers pack the information more or less tightly. This gives rise to single- versus double-sided disks, and such terms as single, double, and quad density.

The result of this variation is that a popular CP/M program will probably be available in several "formats", even though they're all on 5 1/4" floppy disks. In case something you want to run is not available in Morrow format, Morrow has provided you with the **FOREIGN** program. It temporarily makes your floppy drive act as it would in one of the following CP/M machines:

|         |                 |
|---------|-----------------|
| Kaypro  | Televideo       |
| Osborne | Hewlett Packard |

You are then able to copy the program onto your hard disk in Morrow format, ready to run (you can also just run it from the floppy disk.) See pages 4-29 and 4-31.

The second variability in CP/M software has to do with the version of CP/M you're using. Most CP/M software is geared to the relatively primitive version 2.2. Your Micro Decision uses version 3.0. There are a few minor incompatibilities between the versions that occasionally cause 2.2 software to act strangely on your system.

Again, Morrow has taken care of the problem with a set of three programs: **CPM2.COM**, **CPM2.RSX**, and **CPM3.COM**. They simulate the 2.2 version of CP/M on your 3.0 machine. See Appendix C.

-- (\*) --

### How can I run my application programs directly from CP/M?

The first thing to do is either escape from the menus by pressing the **ESC** key at the Co-Pilot Main Menu, or disable the menus altogether as described on page 4-14.

When you see CP/M's "A>" prompt, you're ready for the next steps.

You must log into a certain user number with the **user** command. Then start the program. The user numbers dedicated to the particular programs at the factory are shown below. There's nothing to stop you from staying in user 0, or trying to run the program from user numbers other than those shown. But for the sake of keeping your data organized in the same way that Co-Pilot has been doing, you should stick with the numbers below.

| <u>Program</u> | <u>User Numbers</u> | <u>Typical command</u> |
|----------------|---------------------|------------------------|
| NewWord        | 1, 2, 3             | <b>user 2</b>          |
| Correct-It     | 1, 2, 3             | <b>user 1</b>          |
| SuperCalc      | 4, 5, 6             | <b>user 4</b>          |
| Personal Pearl | 7, 8, 9             | <b>user 9</b>          |
| Quest          | 10, 11, 12          | <b>user 10</b>         |
| BASIC          | 13                  | <b>user 13</b>         |
| Backfield      | 0                   | N/A                    |

Hint: There is a shortcut for entering user commands. Just the number plus a colon (e.g. "3:") is sufficient.

When you run these programs (except BASIC and Backfield) through the menus and pick a file drawer, you are doing the same thing as entering the user command. Notice the message next to the file drawers. It tells you the correlation between a certain drawer and a certain user number. Drawer 1 is the first of the three available, and so on. We mention this because you may have a file you want to work with that's present in only one of the three possible user numbers. So you have to be sure to enter the right user command before going on to the next one.

For example, if you want to edit a NewWord document that's in drawer #2, you'd enter "user 2". For a SuperCalc spreadsheet in its drawer #1, enter "user 4".

The commands for running the programs are listed below. Enter the user command (and RETURN) before typing the program command.

| <u>Program</u> | <u>Command</u> | <u>Program</u> | <u>Command</u> |
|----------------|----------------|----------------|----------------|
| NewWord        | <b>nw</b>      | Personal Pearl |                |
| SuperCalc      | <b>sc</b>      | Welcome        | <b>welcome</b> |
| Quest          | <b>kp</b>      | Design forms   | <b>pearldf</b> |
| MBASIC-80      | <b>mbasic</b>  | Design reports | <b>pearldr</b> |
| Correct-It     | <b>correct</b> | Print reports  | <b>pearlpr</b> |
| Backfield      |                | File maint.    | <b>pearlfm</b> |
| Fullback       | <b>fb</b>      | Enter data     | <b>pearled</b> |
| Quarterback    | <b>qb</b>      |                |                |
| Halfback       | <b>hb</b>      |                |                |
| Select         | <b>select</b>  |                |                |
| Restore        | <b>restore</b> |                |                |

To run the program, simply type the command and press RETURN. For example, to run Correct-It on a file in user number 2, type:

```
user 2 [RETURN]
correct [RETURN]
```

After the first command, the A> prompt changes to 2A> to let you know you've logged into user 2.

If you want to get back into the menus after running the program, type **user 0** and press RETURN, then type **pilot go** and RETURN.

### Utility Menu Equivalents

In addition to the application programs that appear on the Main Menu, you will probably want to run the CP/M commands that are available through the Co-Pilot Utility Menu. Their formats and relationships to user numbers are highly variable, so it will be up to you to experiment until you get the hang of it.

Your best sources for the details are "Fundamental Training in CP/M" on the Utility Menu, and the CP/M Plus User's Guide.

The list below shows the CP/M command equivalents of Utility Menu operations.

| <u>Operation</u>               | <u>Command(s)</u>                                                                                   |
|--------------------------------|-----------------------------------------------------------------------------------------------------|
| Display a directory            | <b>user N</b><br><b>dir [full]</b>                                                                  |
| View or print a file           | <b>view: user N</b><br><b>pip con:=filename</b><br><b>print: user N</b><br><b>pip lst:=filename</b> |
| Copy a file or files           | <b>pip X:COPY[gN]=X:ORIG[gN]</b>                                                                    |
| Format a diskette              | <b>format b d or format b s</b>                                                                     |
| Check disk space and file size | <b>disk space: show X:</b><br><b>file size: dir FILE [user=N]</b>                                   |
| Execute a CP/M command         | (whatever you type is fed to CP/M)                                                                  |
| Rename or erase a file         | <b>rename: user N</b><br><b>ren NEWNAME=OLDNAME</b><br><b>erase: user N</b><br><b>era FILE</b>      |
| Fundamental training in CP/M   | <b>pilot tutorial</b>                                                                               |
| Load Quest Bookkeeper          | <b>pilot quest</b>                                                                                  |

Hint: Whenever you execute one of these command through the Utility Menu, pay careful attention to the screen. The actual command being fed to CP/M from Co-Pilot appears briefly onscreen, next to the A> prompt.

## What is the difference between a CP/M "built-in" command and a "transient utility" command?

Aside from doing grunt work for your business programs like NewWord, CP/M offers a number of housekeeping commands, for looking at directories of disks, erasing and copying files, etc. If you're using the Co-Pilot menus, you run these commands indirectly by way of the Utility Menu.

### Built-in commands

As discussed on page 4-20, CP/M contains three main sections: BIOS, BDOS, and CCP. The CCP (console command processor) shows the A> prompt and contains enough intelligence to handle some of the housekeeping commands itself. These are the built-in commands, and they include:

|              |                                       |
|--------------|---------------------------------------|
| DIR and DIRS | shows a summary of a disk's directory |
| ERA          | erases files                          |
| REN          | renames files                         |
| TYPE         | sends a file to the screen or printer |
| USER         | changes the current user number       |

### Transient Utility Commands

Outside of CCP, CP/M has a library of disk files that do other tasks. They have their own .COM files on disk, just like NewWord and other programs. They are loaded into memory only when you need them. Thus you might see (for example) a "SHOW?" error message if you enter the SHOW command and you're not logged onto the disk drive that contains the SHOW.COM file. This never happens with the built-in commands, since they stay in memory.

These are the more common transient utility files. To enter the command at the A> prompt, just type the first part, leaving off the ".COM" ending.

|            |                                                   |
|------------|---------------------------------------------------|
| PIP.COM    | copies files (plus miscellaneous other tasks)     |
| DIR.COM    | for detailed directories (command is DIR [FULL] ) |
| SHOW.COM   | for disk space and other statistics               |
| SUBMIT.COM | for processing .SUB files                         |

There is other information and a complete list of transient utilities starting on page 4-1 of the CP/M Plus User's Guide. Some programs that might seem to be in this class (like `FORMAT.COM`) are specific to Morrow computers and are covered in Chapter 3 of this manual.

----- NEWWORD AND PRINTING -----

**How do I change NewWord's help level once and for all?  
In other words, how do I get rid of its menus?**

After you've gotten used to NewWord, all those menus at the top of its screen tend to get in the way. You can change the level while NewWord is running with **CTRL-J-H** (also depicted as **^jh**). But you have to do this every time you run NewWord.

Similarly, you might prefer "insert mode" to be off all the time, or a different set of margins. All of these details have default values that you can change with the procedure that follows. Note that we'll just cover the help level; it's up to you and the "Nuts and Bolts" section of the NewWord User's Guide to determine the specifics for other changes.

1. Escape to CP/M from the Co-Pilot Main Menu (type the **ESC** key).
2. At the **A>** prompt, type these commands carefully. Check your typing before hitting **RETURN** at the end of the line. Backspace and retype to correct mistakes.

```
set nw.com [rw]
nwinstal nw
```

3. Look at page 3-3 in NewWord Nuts & Bolts. Your screen should display the same "Main Menu" as is shown on that page. Select **D NewWord Related Items**.
4. Now you see the screen from page 4-2. This is one of the lists of things you can change by re-installing NewWord. In our example, pick **B Help Level**.

5. NewWord reports that the default level is now 3 (the highest) and asks if you'd like to change it. Type **Y**.
6. Then tell NewWord you'd like the new value to be whatever you've habitually been changing it to, probably 2.
7. NewWord confirms your selection and again asks if you want to change it. Type **N**.
8. Type **X** to return to the first menu, and **X** again to exit. Your last response is **N**, for no, you don't want to change anything.
9. When the **A>** returns, type:  

```
set nw.com [ro]
```

and press RETURN.
10. Press the RESET button on the Micro Decision. Run NewWord and check it out.

As you may have gathered, there are many many details of NewWord's operation that you can tinker with, generally at no risk. All the steps are the same as above except the menu selections you make while `nwinstall` is running. Read "Nuts & Bolts" for more information.

-- (\*) --

**Is there a way for me to type on my keyboard and have my printer print what I'm typing at the same time?**

Yes, there are a couple of ways, and one or both should work for you. But you can't be running any program like NewWord, so you're really in the same position as using a typewriter: if you make a typo, it's too late to fix it.

Whichever method you try, you should first verify that your printer is working by printing a file with NewWord.

#### METHOD 1: CONTROL-P

1. Escape from the menus by typing the **ESC** key at the Co-Pilot Main Menu.
2. When you see "A>", hold down the **CTRL** key and then tap the **P** key. Nothing obvious will happen, but your terminal may beep.
3. Now start typing. Your printer may print right along, or it may wait until you press **RETURN**. Those that wait allow you to correct a line for typos, in a crude way.

Unfortunately this technique isn't very useful for correspondence, since every time you type a line, CP/M repeats it and so does the printer. It is useful though for getting rough printouts of files: type **CTRL-P** before entering a **TYPE** command.

4. You can disable the printing by typing **CTRL-P** again or resetting the computer.

#### METHOD 2: PIP

This method is preferable for typing useful text, but there may be some things for you to get used to while typing.

1. Escape from the Co-Pilot Main Menu by pressing the **ESC** key.
2. When you see "A>", type this line and press **RETURN**:  
  
    **pip lst:=con:**
3. Type a few lines: See whether your printer is advancing the paper after printing a line. If it keeps over-printing on the same line, try this:
4. Instead of hitting **RETURN** at the end of a line, hold down the **CTRL** and tap both the **J** and **M** keys in either order. The meaning of this is: When NewWord (or other program) sends a **RETURN** to your printer, it's actually sending two separate commands. One moves the print head back to the left side of the paper (the "carriage return"). The command for this is **CTRL-M**. The other advances the paper one line (a "line feed"). This command is **CTRL-J**.



5. With many printers, you can make the paper advance to the top of the next page with CTRL-L. Check your printer manual for the other codes that will make it behave in interesting ways. For example, with dot matrix printers you can change the width of the characters.
6. To return to the menus, press the RESET button on the Micro Decision. (You may find that CTRL-C will get you out of the typing mode without having to reset. If so, you can then type **pilot go** and RETURN to get back into Co-Pilot.)

-- (\*) --

#### **How do I print things that are appearing on my screen?**

Suppose you want a printout of your hard disk's directory. This is the same CTRL-P function we discussed on the last page. In brief, hold down the CTRL key and tap P prior to entering the DIR command. The printer must be ready to print or the system will lock up.

The effect of CTRL-P is suspended when you run a program like NewWord. Cancel it by entering CTRL-P again.

If you're interested in "redirection," be aware that CP/M won't let you do it. An example of redirection is sending a directory listing into a disk file; from there you could insert it into a document you're editing with NewWord. Some other systems provide for this capability, but not CP/M.

## NON - MORROW SYSTEMS & SOFTWARE

### How do I add other software to my hard disk?

The software you want has to be CP/M 2.2 or 3.0 compatible. Then, it must be available on 5 1/4 inch diskettes in any of these formats:

Morrow Micro Decision  
KayPro  
Osborne  
Televideo  
Hewlett Packard

You'll need to know whether the diskette is single or double-sided. This should be clearly stated on its label.

If it's in Micro Decision format, skip steps 2 through 4 below.

1. Escape from the menus by pressing the **ESC** key at the Co-Pilot Main Menu.
2. When you see "A>", type **foreign** and press RETURN.
3. In response to "Disk drive to be used?", type **B**.
4. Then select the format of the diskette that holds the new software.
5. Insert the diskette in the drive and type **dir B:** and RETURN to verify you've selected the right format. If you can read the diskette's directory, proceed. If you get a "media failure" error message, you've selected the wrong format in step 4 (or it's possible, though unlikely, that the diskette is defective). In that case, return to step 2 and try again.

6. At A>, type:

```
pip A:=B:*.*
```

and press RETURN. Everything on the diskette should be copied onto the hard disk.

7. When "pip" is finished, remove the diskette and press the RESET button.
8. Check the manual that came with your software. It may require that you run an "installation program" before you can use it. If so, escape from the menus (see step 1) and type the name of the installation program. Press RETURN.
9. You're on your own now. But if the installation program gives you a list of terminals, remember what the screen said way back when you first used the Micro Decision. It's not likely that you should actually pick your own terminal from the list, but one of these four instead:

```
Morrow 60 or 70 (Level IV)
Lear Siegler ADM-31 (Level III) true for Morrow
MDT-20 and MDT-50
SOROC IQ-120 (Level II)
Lear Siegler ADM-3A (Level I)
```

If you don't remember what level your terminal is, try installing your software for the ADM-31. Then run it. If the screen looks screwy, run the installation program again, this time choosing the SOROC. If that fails, try it once more with the ADM-3A.

Be aware that you can't run added programs from the menus without extensive editing of the Co-Pilot program MICRO.PIL. So you'll either disable the menus or escape from them whenever you want to use the new program.

Should you decide to revise the menus to include other programs, may we suggest that you make a backup copy of the unchanged MICRO.PIL first. It is on the hard disk in user number 0. Use NewWord's N option (non-document) for working on the file.

-- (\*) --

**How can I create a Micro Decision diskette that is a duplicate of a diskette from a different system?**

**Or, How can I create a foreign diskette with files on it from my Micro Decision?**

These questions are very related to the one above about loading other software onto the hard disk. They both involve using the FOREIGN program.

Copying a foreign diskette onto a Micro Decision diskette

To copy another computer's diskette onto a Micro Decision diskette, it must be a CP/M 5 1/4" diskette in one of these formats:

|                 |                |         |
|-----------------|----------------|---------|
| Osborne         | IBM PC CP/M-86 | 1-sided |
| Hewlett Packard | Televideo      | KayPro  |

1. Follow steps 1 through 7 (including RESET) in the previous question for copying the foreign diskette onto the hard disk. While PIP is running, write down all the names of the files that are being copied from the foreign diskette.
2. When PIP is finished, format a Micro Decision diskette by typing **format B** and a RETURN at the A> prompt. (Be careful not to format the foreign diskette by mistake.) If the Micro Decision diskette will be used exclusively on MD-3's and the hard disk Micro Decisions, select double-sided format (D). If it needs to work with an MD-2, select S for single-sided. Note that a single-sided diskette may not hold everything that's on the foreign diskette.

3. After formatting, leave the diskette in the drive. Then at A>, type:

**pip** (press RETURN)

4. Next to the asterisk (\*), type:

**B:=filename**

where "filename" is the name of the first file from the list you wrote in step 1 above. Press RETURN. When the asterisk returns, type the next file name. Continue until all of the files have been copied.

5. After the last file's been copied to the diskette, press RETURN at the asterisk. A> reappears.
6. You could quit now, but you may want to erase the files from your hard disk if you don't plan to use them. If so, type **era** and the name of the first file on the list. (DON'T type the "B:" this time.) Continue typing **era** commands for all the files on the list.

#### Copying files from your hard disk onto foreign diskettes

You might do this to share data or programs with someone who has one of the computers listed on the previous page. The diskette you're copying onto must have been formatted already on the other computer.

Read the discussion above under "How Do I Add Other Software To My Hard Disk?". This procedure is very similar.

1. Follow steps 1 through 5 of "Adding Other Software."
2. At the A> prompt, type **pip** and press RETURN.
3. Next to the asterisk (\*), type:

**B:=filename** (press RETURN)

where "filename" is the name of the first hard-disk file you want to copy. Continue typing "B:=" and file names until all of the desired files have been copied. Then press RETURN at the asterisk.

4. Type `dir B:` and RETURN to check the floppy's directory for the copied files. Remove the diskette.
5. Press the RESET button on the Micro Decision.

One thing to keep in mind is that when you share a non-game program with someone, aside from the question of copyrights, there will almost certainly be more than one file involved. There will be at least one file ending in `.COM`, and probably another ending in `.OVL` or `.OVR`. Then there may be associated data files. So check the program's manual for a list of necessary files.

-- (\*) --



## CHAPTER 5

### ----- ERRORS AND OTHER NUISANCES

Computers rarely break down, but moving parts can wear out, and electronic parts on rare occasions fail to perform. And, although there is a great deal of excellent commercially available software, most users eventually happen upon a program with "bugs." There is also the occasional, perfectly understandable, human error.

There are two general classes of error messages: operator and disk.

```

* *
* NOTE: You should use the Co-Pilot Utility Menu *
* option "Fundamental training in CP/M" for background *
* on concepts like user numbers and system status. It *
* takes about 15 minutes to learn everything you need *
* for basic familiarity with CP/M, and it will be time *
* well spent. *
* *

```

#### Operator Error Messages

Operator error messages originate from two sources. If you're entering a CP/M command at the A> prompt, they come from CP/M. If you're already running a program like NewWord, they come from that program instead.

#### CP/M Operator Messages

The most common of this type occurs when you mistype a command. Suppose you type "SOHW B:" instead of "SHOW B:". CP/M responds:

SOHW?



Nearly always the solution involves nothing more than careful retyping. Then again, remember that CP/M is searching the current disk drive and user number for the program whose name you've typed. If your prompt says (for example) 10A> and you want to run SuperCalc, one of three things must be true:

1. The SuperCalc program files (SC.COM etc.) must be present in user 10 of drive A.
2. The SuperCalc files are in user 0 of drive A and are set to system status.

If neither is true and you type "SC" at the 10A> prompt, CP/M predictably responds,

SC?

The solution in this case is to change the current user number or drive to reflect the actual location of the SC files.

The second class of CP/M messages appears when you disobey the rules of syntax for a certain command. For example, you can copy a file from one user number to another with a command like "PIP A:[G0]=A:FILENAME[G5]". This means, copy the file FILENAME from user 5 of drive A to user 0. (Why "G" then instead of "U"? Well, they used to be called group numbers; apparently the programmers didn't hear that the nomenclature had changed.)

If you typed this command "PIP [G0]=A:FILENAME[G5]", leaving off the first A:, you'll see

INVALID FORMAT

"Invalid Format" is one of CP/M's favorites. If it isn't clear what you're doing wrong, look in the CP/M Plus User's Guide for the command that you're entering. It will give you the rules for that command in painful detail.

NOTE: A summary of CP/M's error messages can be found in Appendix A of the CP/M Plus User's Guide.

## **Business Program Operator Messages**

These are the easiest to deal with, thanks to the market demand for user-friendly software. Error messages are issued by the program when you attempt to do something it isn't equipped to handle.

Suppose you're running NewWord and you try to erase a block of text without marking its beginning and end points. NewWord responds:

```
You have not yet defined a block.
Use ^KB and ^KK.
TYPE THE ESC KEY TO CONTINUE.
```

Now you know exactly what to do. Most manuals for business programs have an appendix that summarizes its operator messages. NewWord's is Appendix E.

## **Disk Error Messages**

In contrast to operator messages, disk error messages are frequently beyond your control. You may be doing everything exactly right, while the computer or disk is experiencing problems of its own. Because of this, they are often ominous of data loss. And since they originate exclusively from CP/M, they are usually incomprehensible.

Morrow has improved the situation by customizing CP/M to behave a little more nicely when a disk error occurs. The messages are expanded beyond their descriptions in Appendix A of the CP/M Plus User's Guide. More importantly, Morrow's CP/M gives you options for retrying most operations, or continuing regardless of the error. The third option (abort) is what automatically happens in other CP/M systems that don't offer the options.

## Recoverable Disk Errors (Include the R, A, & I Options)

These disk errors may have simple solutions. For example, "Write protected" tells you a diskette you're trying to write on has a write-protect sticker. Remove the sticker (or switch disks) and press R to retry.

Other errors are not so easily handled. We'll cover them one at a time and suggest the proper means for dealing with them.

This may become a familiar sight (we hope not):

```
=====
Disk error on drive x: (...error message...)
Type R to try again, A to abort, or I to ignore:
=====
```

The "x" represents the drive letter for the disk that's having a problem. The possible error messages are covered next; then we'll see what the R, A, and I options are about.

### Drive Not Ready

The disk drive is not ready. If it refers to the hard disk, it usually means that the disk isn't rotating at the right speed. With floppies, a number of things may be happening, including no diskette in the drive, drive door open, or a problem with the drive, cable or disk controller. In some cases, the problem can be solved by simply opening and closing the drive door. If you cannot get the system to work, consult your dealer.

### Write Protected

You have attempted to write to a diskette that is write protected. That means that the write protect notch is covered. If you want to write to that disk, you must remove the write protect tab and try again.

Some diskettes do not have a notch and are therefore permanently write protected. These are generally software distribution diskettes that were protected by the manufacturer to avoid accidental erasure or damage. In most situations, the files on these diskettes can, and should, be copied to the hard disk or a backup floppy.

### Not Found

The disk controller is unable to locate information on the disk. With the hard disk, this means trouble. Type R for retry several times. If this message appears when trying to work with several different files, it's time to restore them from your backups.

With diskettes, this can be caused by trying to access a disk that is either damaged, unformatted, or formatted for a computer other than the Micro Decision. If you are sure that your diskette is properly formatted, it may have been damaged. If you suspect that this is the problem, use the "Copy a file" option on the Utility Menu to copy as much of the information as possible to a freshly formatted diskette.

### Data Address CRC Error ID Address CRC Error Data Error

Whenever information is written on a diskette, additional error control codes are also written. When the information is read back, these codes allow the disk controller to determine if the information has been read correctly. This error is usually caused by a damaged disk, or by a hardware failure in the drive or controller. Whether or not you recover from the error, try copying the contents of the file being read into a new file with PIP or the "Copy a file or files" option from the Utility Menu.

### Equipment Failure

Is that "Taps" playing in the background? Try resetting the computer; then try turning it off and back on. If you can operate the machine at all, be sure you've backed up whatever files you can. Then boot from your Backfield Working Diskette and follow through the steps for restoring the hard disk.

It's possible that even this won't work. In that case, you'll need to take the Micro Decision to your dealer for service.

#### Media Failure

This message is usually associated with floppies whose format isn't right for the Micro Decision. You may run into it when running the **foreign** program. Be sure the diskette you're trying to use is one of those allowed with foreign, and that you've selected the right option.

#### Seek Error

The disk drive was not able to find the correct track on the disk. This can be caused by a diskette which is improperly inserted in the drive, or incorrectly formatted. This can also be caused by a hardware failure in the disk drive.

#### Unable to Remap

Your hard disk does its best to locate the marginal parts of its surface and keep information from going there. This is called "bad mapping." This error message indicates a failure in this process, and is not good news by any means. If it repeats consistently after rebooting and turning the power off and back on, boot from the Backfield Working Diskette and restore your system from your Backfield backup diskettes.

#### Unknown Error Code

None of the above. Something strange has happened; retry a few times before aborting.

#### **Error Message Responses**

After displaying the error message, your Micro Decision waits for a response from you. Only an R, A, or I will be accepted. The results of using these keys are described below.

### R - to Try Again

This is always the first thing to try. Enter an R to try the disk operation again. This is obviously helpful if the error was due to an open drive door, a write protected diskette, or something else that you can easily correct. Sometimes, too, other errors can be cleared by trying again.

### A - to Abort

This is nearly always the thing to do after pressing R several times with no success. Enter an A to abort (terminate) the disk operation. This causes a system "warm boot", re-loading CP/M. Any information which was in memory is lost. The A> prompt returns.

However, when you press A, CP/M gives you the name of the file that caused the problem. This can be extremely helpful when trying to figure out what to do next. If it's one of the program or overlay files that has a copy on one of your Distribution Diskettes, you can restore it with the "Copy a File or Files" option from the Utility Menu.

When you restore such files, you may need to set the damaged hard disk file to read/write status with the CP/M command **set filename [rw]**. After copying in the new floppy file, set it to system status with **set filename [sys]**.

But suppose the problem is in a data file, such as a NewWord document. The obvious thing to do is try working with the .BAK file created by NewWord, or copy back a diskette backup version. Alternatively, try copying the offending file into a new file with a different name, with a command in the format **PIP NEWFILE=OLDFILE**. Try R several times at the failure point, and then I for ignore. (This is recommended for Data or CRC errors.) The copy will have some amount of "garbage" in it at the failure point, but this may be limited to a few easily-repaired lines. At least the error won't occur with the copy as it did with the original.

## I - to Ignore

Enter an I to ignore the error and continue as if nothing had happened. This should be used with extreme caution, especially when writing data to a disk. Using this response can lull you into a false sense of security, since disk operations appear to proceed normally, despite the possibility of a faulty disk or other problem.

The only safe way to use I is this: You have already tried R several times and it didn't help. Then you used A to abort and made a note of which file had the problem. If you had no backup for it, you tried copying the faulty file into a new file, retried at the point of failure, and finally resorted to I. Now you can look at the file (assuming it's a data file - you should certainly have backups of all program files) and locate the garbage. Take out the trash, son.

## **Non-Recoverable (Fatal) Disk Errors**

Some error messages do not give you the option of A, R, and I. There is a logic to this; the nature of these errors make retrying pointless. They automatically abort. These errors occur before the disk operation actually begins. They cause a "warm boot", which reloads CP/M and erases any information that was in memory. If you encounter one of these errors, an error message will be displayed in the form:

```
CP/M error on drive x: (...error message...)
BDOS Function = XX
```

where x is the drive where the error occurred. The BDOS function number won't interest most users. However, if you'd like to interpret it, the BDOS functions are defined in the CP/M Plus Programmer's Reference.

Possible errors are:

### Select Error

An invalid drive name was entered. Valid names are drives A: through D:.

### Disk Read Only

An attempt was made to write to a drive which CP/M has set to "read only". CP/M automatically does this whenever a diskette is changed in a drive without a "warm boot", usually meaning that you haven't entered CTRL-C at the A> or B> prompt after switching diskettes. This is done to prevent CP/M from inadvertently writing to the wrong disk. Programs can also explicitly set a drive to "read only", but this is rarely used.

### File Read Only

An attempt was made to write to a file which has been set to "read only". The SET command can be used to set a file to "read only". This is one way to protect your files from accidental erasure or modifications. All of your program files like NW.COM for NewWord are read only.

Refer to the Co-Pilot Utility Menu option "Fundamental training in CP/M" and the CP/M User's Guide for more information on the SET command.

### Summary

There are several levels at which you can approach disk errors. If you're given the A, R, & I options, try R at least three times, then A. Use I only as described above.

If you get frequent errors of this type, it's probably time to reformat your hard disk and reload all the programs and data. You can do so only if you've made regular backups.

When the machine is brand new and you have problems before you've ever used it, you should boot from the CP/M Distribution Diskette #1 by putting it in the floppy drive, closing the latch, and pressing RESET. Follow the directions onscreen for reloading the software from the rest of the distribution diskettes.

However, in the more likely case that you've added a significant amount of data to the hard disk, you should boot from the Backfield Working Diskette instead. It leads you through the procedure for restoring your hard disk from the diskettes you made yourself while running the Backfield programs.





## CHAPTER 6

### ----- ABOUT YOUR SYSTEM

We've buried this highly descriptive section back here since it gets in the way up front, when you're anxious to get things hooked up and running. If you're a complete novice, you should read through this entire chapter.

The Morrow Micro Decision is a sophisticated and economical hard-disk computer system. With an optional Morrow terminal and a printer, you have all the hardware and software you need for word processing, proofreading, bookkeeping, data base management, financial modeling, and programming in Basic.

#### THE ABSOLUTE ESSENTIALS

This section will be too elementary for many users, even if you've never had a computer before. You probably learned this material as part of your computer-shopping research. But just in case, here it is.

If it looks too simple, skip ahead to page 6-4.

#### **Hardware, Software, Wash-n-ware: Ware Does It All Lead?**

There are two essential elements to any computer system - hardware and software. If you think of your computer as a stereo system, your hardware is like the turntable, amplifier, tuner and tape deck. The software is like your music collection, whether it is on records, tapes, or even FM radio signals. Music brings out the value and power of a fine stereo system. Software brings out the value and power of your Micro Decision.

Or, for a different image that might appeal more to the computer-haters among you: Hardware is the Frankenstein monster, an assembly of pieces from various vendors, dormant on a slab. Software is the lightning-bolt that jolts the monster to life, enabling it to run rampant over the innocent villagers of planet Earth.

## **Types of Software**

There are several types of software, including operating systems, languages, programs, and data.

The operating system is the interpreter which allows the hardware to "talk to" and "listen to" the software. It is an essential element to any system. Your Micro Decision comes with the CP/M operating system, version 3.0 (also known as "CP/M Plus"). It was selected not only because it is a high-quality product, but because it supports a large number of business and personal software packages.

You need an operating system because people who write software don't want to write it specifically for one computer. That limits the market too much. But if they can write it for one operating system that's used on lots of different computers, well now, that's a different story. So CP/M acts as the interpreter between the very unique hardware of the Micro Decision and the very general nature of software like NewWord and Personal Pearl.

A language is the set of rules and terms that a programmer uses to write programs. The language, working through the operating system, tells the machine what the programmer wants it to do. There are many languages compatible with the Micro Decision, ranging from the highly complex, like Z-80 assembly language, to the simple, like PILOT or BASIC.

A program is a set of instructions written in a particular language, that makes your system do what you want it to do. If you want to use your Micro Decision as a word processor, you must use a word processing program, such as NewWord. Additional programs may be purchased, and you can write some yourself using one of the languages provided with your Micro Decision.

Data is the information being processed. If you use NewWord to type chain letters, the actual words of the chain letter are your data, worthless though they be.

As an illustration, let's trace a letter created with NewWord. The letter is data created by the NewWord program. NewWord is written in assembly language and runs under the CP/M operating system.

Files: Your data is stored on the hard or floppy disk in files. Think, for a moment, of your hard disk as a filing cabinet (a worn-out metaphor, of course, but the best nonetheless). It has 16 "drawers," or user numbers. Each user number can contain lots of different files.

A file is the unit of data you work with. It can be completely empty, or it can contain the unabridged "War and Peace." There are several types of files; NewWord actually consists of three program files, two "overlay" files, and three sample text files. Personal Pearl uses over 60 different files!

You too will create files. Every time you type a document with NewWord you create a new file. When you generate a new spreadsheet with SuperCalc that's a new file too. The Micro Decision's menus and CP/M let you name files, copy them, and erase them.

### **Computer Hardware**

The hardware on your Micro Decision consists of a cabinet, a power supply, a central processing unit, memory chips, a disk drive controller, a hard disk, a floppy disk drive, and an assortment of chips, resistors, plugs, and wires.

The "brains" behind the system is the Z80A central processing unit (CPU). This is actually only one chip, about 3/8 inches square.

Another essential element is the Random Access Memory (RAM). Your system is equipped with 128k of memory. Each "k" (short for kilobyte) consists of 1024 bytes or characters. This translates to 131,072 bytes - each byte being the equivalent of one single number or letter.

The Random Access Memory determines how much information your computer can manipulate at any one time. Information stored in RAM can be instantaneously accessed by the computer. RAM acts as a temporary storage area. Any information in RAM disappears when a new program is run, when the computer is turned off, or when the electric company decides to interrupt your power. Fortunately, you have a more permanent means to store information - the hard disk. And as a double safety measure, you will routinely copy what's on the hard disk onto backup diskettes.

## Disks and Disk Drives

Information (data and programs) is transferred between the hard disk, floppy disk, and RAM via the disk controller and disk drives. Disk drives are a little like tape recorders. They read and write magnetically encoded information on the disk. Disks are similar in substance and function to magnetic tape. The disk drive can add information to a disk (as long as there is room) or it can record new information over old, erasing the information that was there before.

-- (\*) --

## SYSTEM HARDWARE

Here's a breakdown of your system hardware: the nuts, bolts and gizmos that make your system run.

- o Z80A (8-bit) Central Processing Unit (CPU)
- o 128K bytes of internal Random Access Memory (RAM)
- o 3 RS-232C serial ports
- o 1 Centronics-type parallel printer port
- o 1 RS-422 high speed synchronous communication port
- o Disk drive controller for one or two 12 megabyte (unformatted) hard disks and one or two 5 1/4 inch floppy drives - NOT 8 inch, by the way
- o 1 hard disk with storage capacities as follows, after formatting and depending on model:
  - MD-5 5.43 megabytes (5,430,000 characters)
  - MD-11 11.0 megabytes
  - MD-16 16.44 megabytes
  - MD-34 34.48 megabytes
- o 1 double sided floppy drive, 384 kilobytes formatted

Be aware that the software that comes with the Micro Decision occupies part of the hard disk storage space.

## SYSTEM SOFTWARE

And now for the actual programs which let you go about your business. These programs (Quest excluded) have been pre-recorded on your hard disk. You have also either received individual distribution copies of each program, or will soon create backup copies yourself. **(Save these! Put them away in a safe place. If you ever have your disk serviced, you may need to copy them back onto the hard disk.)** Here's what you have:

- o CP/M version 3.0      Operating System
- o NewWord              Word processing program
- o Correct-It            Checks and corrects spelling
- o SuperCalc            Financial modeling  
                          ("electronic spreadsheet")
- o Personal  
  Pearl                  A versatile data base  
                          management package that  
                          allows design and produc-  
                          tion of forms and reports
- o Quest                 A powerful accounting and  
                          bookkeeping package
- o MBASIC-80            Microsoft BASIC programming  
                          language
- o PILOT                 Morrow's version of this  
                          popular programming  
                          language
- o BACKFIELD            Backup program for the  
                          hard disk
- o Co-Pilot Menus      Your road map through CP/M

## SYSTEM REQUIREMENTS

Your Micro Decision comes with all the basics (computer hardware and software) needed to get started, but to complete your system, you will need the following:

### Terminal

A computer terminal is required for communicating with your computer. Although the Micro Decision works with most computer terminals, the Morrow MDT-60 and MT-70 are recommended for those wishing to take full advantage of the software included with the Micro Decision.

### Diskettes

The floppy drive in the Micro Decision uses 5 1/4 inch soft-sectored double-sided floppy diskettes. For best results, use only premium quality diskettes that are certified for use as double-sided and double-density. These diskettes are available from most computer and office supply dealers. You need at least seven diskettes for your first full backup of the hard disk. We recommend that you have a box of ten diskettes on hand.

**CAUTION:** Diskettes are vulnerable to accidental erasure or damage. Before you begin using them, please read page 6-11 and 6-14 for important information on their care and handling.

## OPTIONAL HARDWARE

There are three RS-232 serial port connectors on the back panel of the Micro Decision. One is marked TERMINAL, another PRINTER/MODEM, and the other AUX. The first one must be used for your terminal. The others can be used for a printer, a modem, or any other serial device that is compatible with your system. See Appendix D and E for information on how to set up these ports.

### Printers

The Micro Decision works with most letter quality and dot matrix printers. Serial printers plug into the back panel connector (or "port") labeled PRINTER/MODEM. Parallel printers connect to the flat edge connector on the back panel labeled CENTRONICS PARALLEL. In some cases, the set up of the PRINTER/MODEM port may need to be changed (for a different baud rate, for example). This procedure is described on page 1-17.

### Modems

A modem (short for MODulator-DEModulator) connects your Micro Decision to a telephone line and allows you to exchange programs and data with other microcomputers, or with larger computers. You can also access computerized information services such as The Source and CompuServe with a modem.

The modem connects either to the PRINTER/MODEM port or the AUX port. The AUX port is recommended. You will "install" the modem software to tell it which connector you're using.

Morrow has made available its own intelligent modem (Model MM300) that comes with complete controlling software. Your dealer can provide you with information about other modems that can be used with your Micro Decision. Again, see Appendix D and E for information on connecting these devices. (Note: Connecting your Micro Decision to a modem requires special communications software that is usually supplied with the modem itself.)



## ADDITIONAL SOFTWARE

The Micro Decision was shipped with several useful and popular application programs. In addition, your Micro Decision is capable of using most of the many programs that run using CP/M. This opens the door for communications programs, games and much more. Some of the CP/M users groups distribute free software. See your dealer for information on available software.

You also need to know that there are several CP/M diskette formats. By format, we mean the pattern on a diskette that the operating system expects before it can read or write information on it. The Micro Decision uses standard 5 1/4" soft sector diskettes, but in order for it to read a program or data diskette, the diskette must use a format that the Micro Decision knows about. A format program is included on your system diskette to prepare diskettes for use with your system.

In addition to diskettes specially formatted for the Micro Decision, your system can run program diskettes, and read and write data diskettes that have been formatted for the Osborne, Televideo, Hewlett Packard, and Xerox computers. Additionally, it can read and write to CP/M-86 data diskettes formatted by an IBM Personal Computer.

Software publishers and distributors are generally able to provide CP/M programs in one of the formats available on the Micro Decision.

A final note: some CP/M software that is designed to use version 2.2 of CP/M may not work exactly right on the hard disk Micro Decision. Morrow has supplied a couple of small programs that usually solve any such problems. See Appendix C.

## THE MICRO DECISION'S DISK DRIVES

The Micro Decision has one hard disk, whose capacity depends on the model you've chosen (see page 6-4 for details). It also has one floppy disk drive, that can pretend that it is two other "virtual drives."

### The Hard Disk

The hard disk gets its name because it is not flexible like a floppy diskette. You don't remove it like a diskette. The hard disk stays put in a sealed enclosure. There are other significant differences between a hard disk and a diskette.

Unlike a floppy, the read-write "heads" inside the drive do not physically rest on the actual disk. The heads and the disk are separated by a cushion of air. Once you turn on your system, you cause the hard disk to spin at a tremendously high speed - 3600 revolutions per minute - 12 times faster than a diskette.

A hard disk outperforms a diskette for several reasons:

**More information more quickly.** Since the disk is spinning so fast, the head can read and write information more quickly.

**More storage.** You just have more sheer storage space. A double density double-sided diskette can store up to 384K or roughly 400,000 characters. An 11 megabyte hard disk, as used in the MD-11 model, is equivalent to more than two dozen diskettes housed under one roof.

**Less wear and tear.** Since the hard disk is sealed in an airtight enclosure, it's protected from the many mishaps that befall floppies. This includes coffee and soda spills, dust and smoke, fingerprints, ball point pen impressions, - all the "no-nos" that every technical manual warns you against. The hard disk also has a longer life span than a diskette - 8000 to 10,000 hours as compared to a floppy's 1600 hours.

Your hard disk is probably the reason why you bought the Micro Decision. If you've had extensive experience with a floppy-only computer (or, heaven forbid, one that uses cassette tapes), you'll be pleasantly amazed at how convenient a hard disk system is to use. Not only is it strikingly fast, but there's no swapping floppies around, logging onto this drive and that, forgetting which diskette is which. . .

No, it's all there in one place. With the MD-11, for example, it's more than eleven million letters, numbers, and other characters. This is about 5,000 standard pages worth.

But - all this information crammed onto one mechanical device is a frightening prospect to people who've lost data to malfunctioning hardware. Therefore it is essential that you develop good backup habits, and take good care of the hard disk.

#### **Hard Disk Rules Of The Road:**

1. Make a full backup of the hard disk as soon as you can, as described in Chapter 2 under "Backfield."
2. At the end of each day, make an "incremental" backup with Backfield. This backs up only the files that have changed since the previous backup. Now the absolute worst that can happen is the loss of one day's work.
3. Always PARK your disk heads before turning the Micro Decision off. This selection is also covered in Chapter 2.
4. Avoid jolting the Micro Decision. Move it smoothly and carefully. When transporting it over long distances, pack it in its original packing materials.
5. Also while moving the computer, keep a spare diskette or the original cardboard slip inside the floppy disk drive.

We don't mean to scare anyone into thinking that the Micro Decision is sitting there waiting for a chance to gobble up your data. It's doubtful you'll ever run into any serious problems. But we don't want to lull you into thinking you can just let the thing accumulate data month

after month with nary a backup. That's downright foolhardy. So follow the rules above, and all will be well, because (if we may quote every technical manual ever written) "this quality machine was designed to give you years of trouble-free service."

### How Floppies Fit Into the Picture

You also have a floppy disk drive. You ask, "What's it for?" Good question. You will be using floppies to load new programs onto the hard disk, or to store backup copies of your hard disk files.

### Why Are They So Sensitive, Anyway?

The figure below shows the external details of a floppy diskette. Unlike the hard disk, the recording surface of a floppy is exposed to the elements, i.e. your fingers, magnetized paper clips, dog teeth. . .

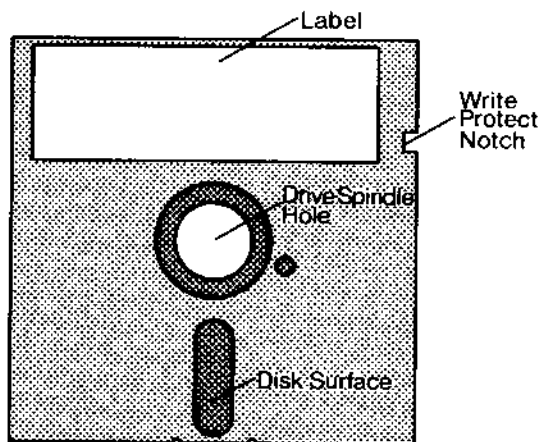

Figure 6-1. Floppy Diskette Features

### Basic do's and dont's for diskettes:

1. Always hold them by the label end. DON'T touch the exposed surface.
2. Don't try to remove them from the black sleeve that surrounds them. (Don't laugh - people have been known to do this.)
3. Don't try to force a drive door shut on a diskette. If you're meeting resistance, the diskette is probably inserted wrong.
4. Write information on a label before you stick it on the diskette. If you must write on an already-stuck label, do so with a felt tip pen, NOT a pencil or ball point.
5. Remove diskettes from the drive before turning off the Micro Decision. Store them in a clean dry place, inside their paper sleeves.

### Formatting Diskettes

We just want you to be aware at this point that you always have to format brand new blank diskettes before you can use them with the Micro Decision (or any computer). Each computer has its own special way of formatting, so unless your friend has a Micro Decision, you won't be able to format diskettes for each other.

Be aware that formatting a disk erases everything that might be on it. Thus you can recycle old disks by reformatting them. But be careful: one of the worst things you can do is to reformat a valuable disk by accident. This is why we say you only format new blank disks, not new ones with software on them.

Formatting a diskette takes about two minutes. It is a fully automatic operation that you can execute from either the Co-Pilot Utility Menu or the Backfield Options Menu.

A final word: Although you can format diskettes only in Micro Decision format, your Micro Decision can read and write on diskettes formatted on several other computers. See "FOREIGN.COM" in Chapter 3.

## Write Protection

Notice the "write protect notch" in Figure 6-1. This notch should be uncovered when you buy brand new diskettes. An uncovered notch means that you can format the diskette, copy files onto it, and rename or erase them as you wish.

Diskettes usually come with a little sheet of stickers designed specifically for covering this notch. When it's covered, you can do nothing with the diskette but read information off of it. This is write protection. You would normally write-protect very valuable backup disks to keep them from being changed or erased.

Apply a write-protect sticker by wrapping it around the notch, neatly covering it on both sides.

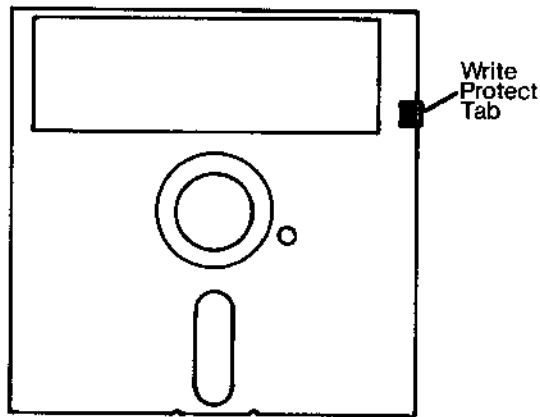
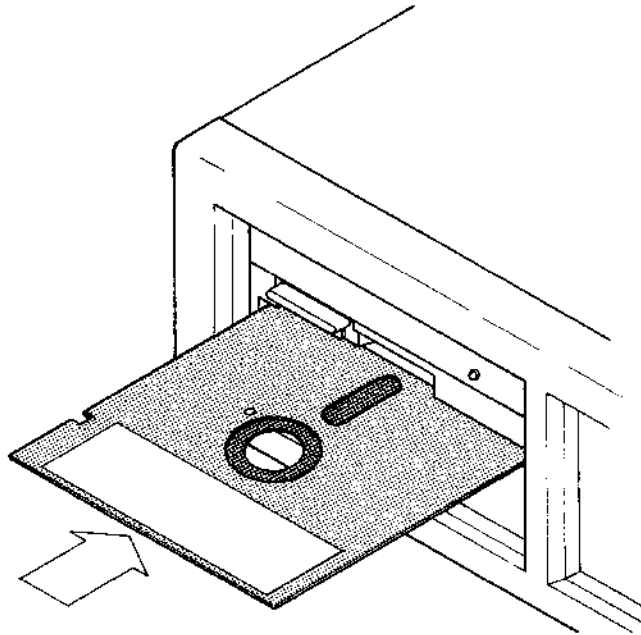

Figure 6-2. A Write-Protected Diskette

## Inserting Diskettes

1. Open the door of the disk drive. There are several types of latches, but virtually all of them have a handle that covers the slot for the diskette. You open the latch by flipping it up or to the side so that the slot is now uncovered.
2. Touching only the plastic shield and label, insert the diskette all the way into the drive with the label facing up and the notch (if any) to the left. The exposed oblong shaped area is inserted first. Think of that oblong as an arrow, pointing the direction in which the diskette is inserted.



**Figure 6-3. Inserting the Diskette**

3. Close the disk drive door by flipping the latch down again. Don't force it - if it seems stuck, open it, remove the diskette, and start over.

## Disk Drive Letters

An incidental bit of info: Disk drives have certain letters associated with them. Nearly always, the hard disk is your "A" drive and the floppy is "B". Then you have two "virtual" drives C and D, which are used when you need to pretend that you have more floppies than you actually have. Virtual drives are a carry-over from all-floppy computers. They are much less needed with a hard disk system. See also page 4-3.

The only thing that would change the A and B letters is if you should need to "boot from the floppy". This is a rare occurrence that usually means your hard disk is having problems. When you boot from the floppy, the floppy becomes drive A and the hard disk B. C and D are still virtual floppy drives. See also page 4-7.

## "Virtual" Floppy Drives

The Micro Decision can pretend that it has two more floppy drives than it actually has. You will use this feature to copy files directly from one floppy to another, or perhaps when reading and writing in foreign disk formats.

Virtual drives are extremely useful in floppy-only systems, where you may be dealing with three diskettes at a time. With a hard disk, however, there is less need for this feature. Nonetheless, here's an example of copying a file from one floppy to another without getting the hard disk involved:

- o Suppose you want to copy a program onto a Micro Decision diskette from an Osborne diskette. First, you'd escape to CP/M from the menus. Then you'd run FOREIGN and assign drive C to be Osborne format. Then you would enter a copy command like:

```
pip B:=C:osbprog.com
```

("osbprog.com" is used here as just an example.) Your screen responds:

**Your floppy drive is being reassigned as drive C.  
Exchange diskettes and press RETURN.**



So you'd put in the Osborne diskette and the Micro Decision would read osbprog.com into memory. Then the drive is reassigned back to B, or regular Micro Decision flavor. Switch diskettes again, and osbprog.com is written from memory to the Micro Decision diskette. If osbprog.com can't fit into memory all at once, you'll switch disks at least twice.

Thus you have performed an operation that normally requires two disk drives with only one. This is what virtual drives are all about.

### THE CO-PILOT MENUS

The CP/M operating system has many powerful commands. Although they can be learned with a little practice, they tend to be somewhat intimidating for the novice user. To make your Micro Decision easier to use, we have implemented the Co-Pilot Menus - a series of screens which allow you to enter commands with no knowledge of CP/M. Using the menus reduces many complex commands to a single keystroke - a feature that even experienced computer users will appreciate.

All of the commands executed through your Co-Pilot Menus can also be executed directly from CP/M. If you study the screen as you use the menus, you will see what the operating system is actually doing. It's as if you have a CP/M expert sitting next to you, pressing the keys as you watch.

Every function that is available through the menu system is discussed in Chapter 2. The equivalent CP/M commands are listed starting on page 4-21.

### ABOUT YOUR KEYBOARD

The keyboard on the Morrow MT-70 Terminal (and most other terminals) is similar in many respects to a standard typewriter keyboard. However, there are some extra keys that are used to send special instructions to the computer. How the keys work depends on the software. Nevertheless, there are some keys that are commonly used by many programs and these are described below.

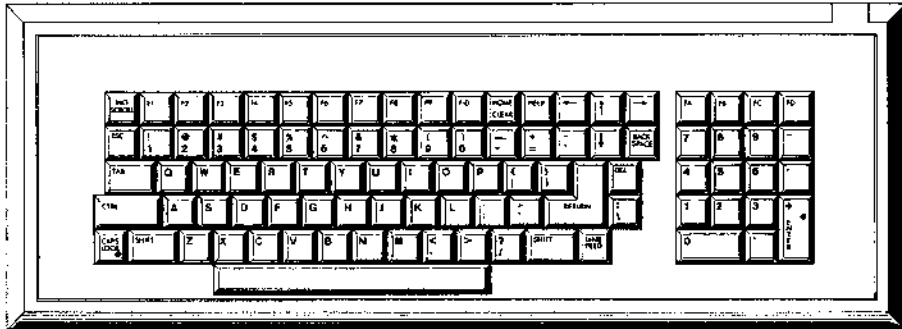

**Figure 6-4: Typical Keyboard**

#### **ESC Key**

The use of the ESC (short for ESCAPE) key depends on the application program. In NewWord, for example, you are asked to press the ESCape key after executing certain commands. ESC is also used in the Co-Pilot Menus to back up to the previous menu, or to escape out of the menus to CP/M.

#### **CAPS LOCK Key**

The CAPS LOCK key (also called ALPHA LOCK or ALL CAPS key) is like the shift lock key on a typewriter. It causes all letters typed to be in upper case. It has no effect on the number or punctuation keys, however.

Normally you press CAPS LOCK once to activate all caps, and again to de-activate them. Some keyboards deactivate CAPS LOCK when you press the SHIFT key.

#### **SHIFT Key**

The SHIFT key works like the shift key on a standard typewriter. To type an upper case letter (or a symbol above a number key), hold down the SHIFT key and type the letter or number.

## **CTRL Key**

The CTRL key (short for CONTROL) is always used in conjunction with another key to send a special command to your computer. Your keyboard has 26 letter keys (A through Z). The CTRL key can be used with these to add an additional 26 "keys" to your system. It can also be used with some of the symbols, for a total of 32 "keys".

The CTRL key is used just like the shift key. When you are asked to enter CTRL A, hold down the CTRL key and press the A key. The CTRL key is sometimes referred to by the "^" symbol. If a manual or help menu tells you to press ^A, it is asking you to press CTRL A, not the caret symbol that often appears on the 6 key.

You will find the CTRL key especially important when you begin using programs like NewWord. To delete a word, for example, the NewWord manual instructs you to type ^T. In this case, you hold down the CTRL key and, without releasing it, press T. Although this may sound cumbersome, it is very easy to get used to.

## **BACK SPACE Key**

The BACK SPACE key is used both to back over characters and to erase characters. Both these functions depend on the program you are running at the time. In NewWord, for example, pressing the BACK SPACE key will back the cursor over the characters, but will not erase them. Under CP/M, however, BACK SPACE erases characters as it backs up, just like the DELETE key.

## **DELETE Key**

The DELETE key (sometimes called the RUB OUT key) is used in CP/M and most application programs to back over and erase characters.

## **RETURN Key**

The RETURN key (sometimes called the ENTER key) is somewhat like a carriage return on a typewriter, but has additional uses. When doing word processing, for example, it is used to end a paragraph. In most cases, the RETURN key must be pressed to execute your command; in fact, many programs do not recognize commands until the RETURN key is pressed. That's why it is sometimes called the "ENTER" key - it is used to enter commands.

## **NO SCROLL**

This key has the same effect as CTRL-S and CTRL-Q. These Control key codes freeze text that is scrolling up your screen, usually after a CP/M "type" command. NO SCROLL makes it stop just like CTRL-S does. Pressing NO SCROLL a second time resumes the scrolling, like CTRL-Q.

## **Numeric Key Pad**

Many terminals have a numeric key pad which is similar to an adding machine or calculator key pad. This pad is handy when using programs that require a substantial amount of numeric entries. The keys on the numeric key pad can be used interchangeably with the number keys above the letters on the keyboard. Also, its ENTER key is exactly the same as the RETURN key.

## **Special Symbol Keys**

There are several special symbol keys on your Morrow terminal (and most other terminals) that do not appear on standard typewriters, and there are common symbols which serve double duty on a computer. These symbols are used in languages and programs for arithmetic functions. These are covered in the manuals that accompany BASIC, Super-Calc, and other languages and programs that use such symbols. Although their use can vary, this table illustrates some common symbols and their definitions:

| <u>SYMBOL</u> | <u>RESULT</u>  |
|---------------|----------------|
| <             | Less than      |
| >             | Greater than   |
| +             | Addition       |
| -             | Subtraction    |
| *             | Multiplication |
| /             | Division       |
| =             | Equals         |

## **Function Keys**

Function keys are available to be programmed to stand for a certain command, sequence of commands, or string of text. Every terminal is different where function keys are concerned. (By function keys, we mean keyboard keys usually labelled "F1", "F2", etc.) Some terminals have a few, some have a bunch, others have none at all.

And then, there are no standards for the codes that function keys send out. So trying to program them to do useful work can be a hassle.

However, when the Micro Decision is used with a Morrow MDT-60 or MT-70 terminal, the function keys are easy to program and are in fact already programmed to do things in NewWord, SuperCalc, and Quest. You can change their meanings to meet your needs by editing special "key definition files" with NewWord or some other text editor. Read about "KEY.COM" in Appendix B.

By the way, "function keys" includes more than the F1-type keys. It also includes the cursor keys, HELP, HOME, TAB, ERASE (MDT-60 only), SETUP (MDT-60) and FA through FD (MT-70 only).

If you are using a terminal other than the MDT-60 or MT-70, you'll need a piece of auxiliary software like "Smart Key" to translate the codes sent out by the terminal into actual commands or strings of text. Ask your dealer about function key software.

### **Cursor Keys**

In general, cursor keys (the ones with arrows on them) are just four more function keys. There are no guarantees that the codes they send out will really move your cursor correctly. As with the other function keys, the Micro Decision is preprogrammed to recognize the MDT-60 and MT-70 cursor keys (Appendix B). If you have another terminal, you'll probably need auxiliary software to make them work right. See "Function Keys" above.

## APPENDIX A

### BACKFIELD USER'S GUIDE

#### CONTENTS

NOTE: Not to discourage your curiosity by any means, but you probably don't need to read any of this except pages A-1 through A-3. The Co-Pilot menus provide all of the essential details onscreen when you run Backfield. For technical details on Backfield, however, this is the right place.

#### BACKFIELD CONFUSION FACTORS

|                                |     |
|--------------------------------|-----|
| The Working Diskette . . . . . | A-1 |
| Backup Diskettes . . . . .     | A-2 |
| Extremely Large Files. . . . . | A-3 |

#### INTRODUCTION

|                                                  |     |
|--------------------------------------------------|-----|
| Installing Backfield on the Micro Decision . . . | A-4 |
| General Instructions . . . . .                   | A-4 |
| What is the Backfield? . . . . .                 | A-4 |
| Why Back Up? . . . . .                           | A-6 |

#### USING BACKFIELD: A TUTORIAL

|                                                |     |
|------------------------------------------------|-----|
| Saving Everything - FULLBACK . . . . .         | A-6 |
| Daily Backup - QUARTERBACK . . . . .           | A-8 |
| Backing Up One Large File - HALFBACK . . . . . | A-9 |
| Complete Restore - RESTORE . . . . .           | A-9 |
| Restoring a Single File - SELECT . . . . .     | A-9 |

## REFERENCE GUIDE

|                                                    |      |
|----------------------------------------------------|------|
| Backup Procedure . . . . .                         | A-10 |
| FULLBACK Operation . . . . .                       | A-11 |
| Program files . . . . .                            | A-11 |
| The checksum file . . . . .                        | A-11 |
| Backup diskettes . . . . .                         | A-11 |
| Options . . . . .                                  | A-12 |
| Backup drives . . . . .                            | A-12 |
| The backup ID code . . . . .                       | A-12 |
| Parameters . . . . .                               | A-12 |
| Default parameters . . . . .                       | A-13 |
| The parameter file . . . . .                       | A-13 |
| The command line . . . . .                         | A-13 |
| Prompts . . . . .                                  | A-14 |
| Overlay files . . . . .                            | A-14 |
| User numbers . . . . .                             | A-14 |
| Restrictions and limitations . . . . .             | A-14 |
| Running FULLBACK . . . . .                         | A-14 |
| Restoring files backed up by FULLBACK . . . . .    | A-15 |
| Messages issued by FULLBACK . . . . .              | A-15 |
| QUARTERBACK Operation . . . . .                    | A-19 |
| The program files . . . . .                        | A-19 |
| The checksum file . . . . .                        | A-19 |
| The backup diskettes . . . . .                     | A-19 |
| Options . . . . .                                  | A-20 |
| Backup drives . . . . .                            | A-20 |
| Parameters . . . . .                               | A-20 |
| Overlay files . . . . .                            | A-20 |
| User numbers . . . . .                             | A-20 |
| Restrictions and limitations . . . . .             | A-20 |
| Running QUARTERBACK . . . . .                      | A-21 |
| Restoring files backed up by QUARTERBACK . . . . . | A-21 |
| Messages issued by QUARTERBACK . . . . .           | A-22 |
| HALFBACK Operation . . . . .                       | A-26 |
| The program files . . . . .                        | A-26 |
| The checksum file . . . . .                        | A-26 |
| The backup diskettes . . . . .                     | A-26 |
| Options . . . . .                                  | A-26 |
| Backup drives . . . . .                            | A-26 |
| Parameters . . . . .                               | A-26 |
| Running HALFBACK . . . . .                         | A-27 |
| Restoring a file backed up by HALFBACK . . . . .   | A-27 |
| Messages issued by HALFBACK . . . . .              | A-27 |

|                                          |      |
|------------------------------------------|------|
| RESTORE Operation . . . . .              | A-30 |
| The program files . . . . .              | A-30 |
| Parameters . . . . .                     | A-30 |
| User numbers . . . . .                   | A-30 |
| Running RESTORE . . . . .                | A-30 |
| Messages issued by RESTORE . . . . .     | A-32 |
| SELECT Operation . . . . .               | A-24 |
| The program files . . . . .              | A-34 |
| Parameters . . . . .                     | A-34 |
| Running SELECT . . . . .                 | A-34 |
| Note regarding parameter files . . . . . | A-35 |
| Messages issued by SELECT . . . . .      | A-36 |
| BACKFIELD Utilities . . . . .            | A-38 |
| BFDIR . . . . .                          | A-38 |
| BFERASE . . . . .                        | A-38 |
| CHANGE . . . . .                         | A-38 |
| COMPARE . . . . .                        | A-38 |
| CRC . . . . .                            | A-38 |
| Examples . . . . .                       | A-39 |
| Reference Summary . . . . .              | A-43 |



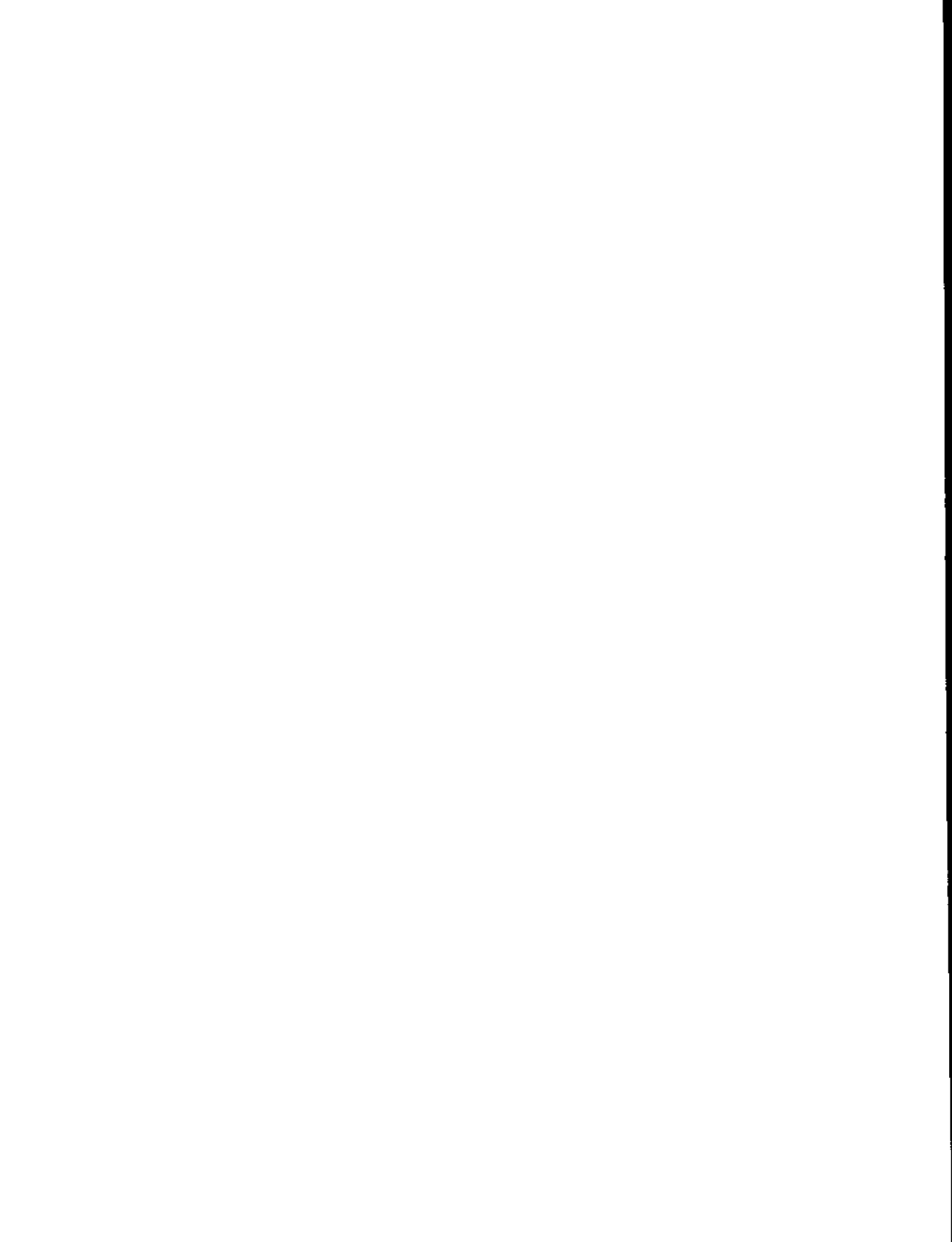

## APPENDIX A

### ----- BACKFIELD - YOUR HARD DISK BACKUP PROGRAMS

You were introduced to Backfield in Chapter 2. There you (supposedly) made your first full backup of the hard disk. Now if something were to go wrong with the hard disk, you could restore it completely by:

- o Booting from the Backfield Working Disk, which you made when first setting up the Micro Decision. It in turn leads you through...
- o Loading the data back onto the hard disk from the set of backup disks that you made with Backfield in the Chapter 2 exercise.

The Backfield Options section of the Co-Pilot Menu System makes using Backfield very easy and almost fool-proof. Therefore you probably will not need to read this appendix. However, if you have unusual needs, you'll find that Backfield offers certain options that aren't available through the menus. They are discussed here. In that case you'd run the appropriate Backfield modules directly from the A> prompt.

```

* *
* NOTE: For many users, the first three pages of this *
* section are all that we recommend as necessary read- *
* ing on Backfield. If you are not using the Co-Pilot *
* menus, then you will likely want to read this entire *
* appendix. *
* *

```

#### BACKFIELD CONFUSION FACTORS

##### 1. The Working Diskette

When you first set up your hard disk system, part of the automatic installation procedure is the creation of your "Backfield Working Diskette" from a new, blank diskette.

The purpose of this diskette is to run the programs for restoring data onto a damaged hard disk. This is necessary since the hard disk is damaged, and there's no way to access these programs on the hard disk; they must be on a floppy disk.

```
* * * * *
*
* The Backfield Working Disk is NOT a backup disk! It *
* contains only the hard-disk restoration program. It *
* does NOT contain the data from your hard disk. You *
* have to create your own backup disks as you did in *
* Chapter 2 before the Working Disk serves any purpose.*
*
* * * * *
```

Don't confuse either the Working Diskette or the Backup Diskettes with the Backfield Distribution Diskette that came with the system. This diskette is only used in case your hard disk was damaged in transit before you ever used it, in which case its contents would be re-copied onto the hard disk. Otherwise you'll never use it for anything.

## 2. Backup Diskettes

Some users have become confused about the various diskettes that are produced during full and partial backups of the hard disk. Here's the low-down:

When you make your first full backup with the FULLBACK module as in Chapter 2 (item #3 on the Backfield Options menu), you'll have a set of about 7 diskettes. These disks should have been labelled with the words "Full backup" (or equivalent), plus the date, and the individual volume number of each diskette. These disks serve no other purpose than insurance against a major disk failure. You cannot read or write on them with any program besides Backfield.

When you make your first partial or "incremental" backup with the QUARTERBACK module (item #4 on the Backfield Options menu), you must use DIFFERENT diskettes. **DON'T RE-USE THE DISKETTES MADE WITH THE FULL BACKUP.** Now you'll have a set of Full Backup diskettes, plus a few additional Partial Backup disks.

If you have a hard disk failure at this point, you would use your Backfield Working Diskette (see above) to initiate the restoration process. Then you'd use your Full Backup set to get most of your data back, and finally option #6 on the Backfield Options menu to get the rest of the data back from the Partial Backup disks. The only data that is lost is any data created after the most recent partial backup.

A final note: Any time you do a full backup (once per week or month, say) you can recycle the current set of Full Backup diskettes. You don't need to reformat them; just change the dates on the labels. (To re-use these disks for any other purpose, you would have to reformat them.)

If you've added a significant amount of data to the hard disk, you may run out of the recycled disks before you're finished backing up. Be sure that you have enough extra diskettes already formatted, to contain the backups of the additional data.

Once a full backup is completed, any Partial Backup diskettes that you have accumulated are no longer needed. Reformat them and use them for whatever you like, including future backups.

### 3. Extremely Large Files

Backfield has to handle very large files in a special way. We mean files too big to fit on one disk, that is, files larger than 384K. Usually this means a large database. If you're running Backfield through the menus, there's only one thing you need to be aware of:

Option 4 (Backup only those files that have changed) does not back up these large files. It issues a warning to this effect onscreen and proceeds to the next file. To back up such a file, you need to use option 3 (full backup) or 5 (backup an extremely large file). We recommend option 5, because it's probably unnecessary to do a full backup, and restoring a single large file from a full backup set is very tedious.

Make special note of this if you are using a database program, for example, for mailing lists. It is likely to change frequently and if it exceeds 384K in size, it will never be backed up by option 4.

## INTRODUCTION

The Backfield is a set of programs for performing routine floppy backups of your hard disk. Separate programs which control full and partial backups can be set up to best fit your business routines. In general, here is how you'll use Backfield:

- o Use the FULLBACK program periodically (once a week or so) to back up the entire hard disk.
- o Use QUARTERBACK more frequently (daily is recommended) to back up only those files that have changed since the previous FULLBACK or QUARTERBACK.
- o Use HALFBACK to efficiently back up large selected files, such as data bases.
- o Use RESTORE to copy the FULLBACK backup diskettes back onto the hard disk, in case of catastrophic disk problems.
- o Use SELECT to copy particular files from backup diskettes created with FULLBACK or HALFBACK.
- o Use PIP to copy files from backup diskettes created by QUARTERBACK.

### Installing Backfield on the Micro Decision:

This process is automatic. It consists of creating a Backfield Working Diskette that is "bootable". This lets you start your system with it in case your hard disk becomes completely disabled. Then it leads you through an automatic process that restores your hard disk from the backup diskettes (we hope) you have made.

Creating the Backfield Working Diskette takes place as part of the general software installation that occurs when you first set up your Micro Decision.

### General Instructions

All of the Backfield programs can be run through the Co-Pilot Menu System. "Backfield" appears on the Main Menu, and it leads to a second menu for more specific choices. More experienced users may run any of the Backfield programs from the A> prompt, in user number 0.

### **WHAT IS BACKFIELD?**

Backfield is a professionally designed software package for hard disk backup. It consists of a set of CP/M programs that efficiently back up a hard disk onto floppies.

Backfield is based on techniques that have been developed over the years for use on large systems. The underlying methodology is this: periodically (for example, once a week) the entire disk is backed up; at shorter intervals (for example, daily) an "incremental" back up is done, backing up only what has been changed or added since the last full backup.

Backfield consists of five programs: three backup programs and two restore programs.

1. FULLBACK backs up an entire CP/M logical drive to floppies, as quickly as the hardware and the CP/M BIOS allow. It backs up only sectors that are currently in use. It can also read a list of file types, and either backup only files having these types, or backup all files except files having these types.

For maximum efficiency, FULLBACK writes its output diskettes in its own format, a format not readable by CP/M; it also writes a "disk label" in the first sector of each backup diskette. To restore from a FULLBACK backup, a special RESTORE program is used.

FULLBACK corresponds to item 3 on the Backfield Options Menu.

2. QUARTERBACK is an "incremental" backup: it backs up only files which have been changed or added since the last FULLBACK or QUARTERBACK run. QUARTERBACK uses a special checksum file written by FULLBACK to decide which files to back up. QUARTERBACK updates the checksum file, so it is always current.

QUARTERBACK backs up file-by-file. QUARTERBACK is slower than FULLBACK, but its output diskettes are in CP/M format. Files backed up by QUARTERBACK are restored by means of PIP or another file-copy utility. PIP can be accessed with item 6 on the Backfield Options Menu.

QUARTERBACK corresponds to item 4 on the Backfield Options Menu.

3. HALFBACK is used to back up one large file, for example, a data base. It is similar to FULLBACK, optimizing memory and disk usage. HALFBACK and FULLBACK both handle a CP/M random file which may contain allocation "holes".

HALFBACK corresponds to item 5 on the Backfield Options Menu.

4. RESTORE completely restores a FULLBACK backup, destroying the current contents of the disk being restored, and replacing them with the data from a previous FULLBACK run.

RESTORE is used in extreme cases only. The Backfield Distribution Diskette is processed during installation to reformat the hard disk and initiate RESTORE. It is not accessible through the Backfield Options Menu.

5. SELECT reads backup diskettes written by FULLBACK or HALFBACK, selects a single file, and writes it in CP/M format to the target disk. It does not destroy the current contents of the target disk.

SELECT corresponds to item 5 on the Backfield Options Menu.

There are two other selections on the Options Menu: Format diskettes (FORMAT.COM) and Duplicate diskettes (BACKUP.COM).

#### WHY BACK UP?

The primary reason for backing up disk storage is to protect against the loss of valuable data through machine error or human error. No matter how reliable the equipment, no matter how careful the user, errors will occur; and when they do, the cost of recovery can far outweigh the cost of "insurance".

**DON'T WAIT FOR DISASTER TO FORCE YOU INTO THE BACKING-UP HABIT.  
START TODAY. AND KEEP IT UP EVERY DAY.**

#### USING BACKFIELD: A TUTORIAL

The purpose of the tutorial is to introduce the five programs that make up the Backfield software package. For a complete description of the use and capabilities of each program see the REFERENCE section of this appendix.

Each program in Backfield is designed for a specific purpose. The examples in the tutorial were chosen to show how Backfield was intended to be used. This section of the appendix should be studied to help understand the different parts of the Backfield software package.

The computer system used for the examples below is assumed to have one hard disk consisting of a single logical drive, A:, which has 16 user areas (0-15) currently in use. The computer also has one floppy disk drive, B:. For a full explanation of any error messages that might occur while using the tutorial, refer to the REFERENCE section of this appendix.

#### Saving everything - FULLBACK

FULLBACK is designed to save a complete image of a CP/M logical drive. You may wish to go ahead and perform FULLBACK with your new system, even though you have been supplied a set of CP/M format backup diskettes already. In any case, after entering any substantial amount of data onto your hard disk through using your spreadsheet, database, and word processing programs, you should use FULLBACK.

First, you should prepare six formatted diskettes. (Later when the hard disk is fuller you may require 10 or even 20 diskettes for FULLBACK.) Use the "Format one or more diskettes" option from the Backfield Selection Menu or type **format** at the A> prompt. Format the diskettes as double-sided.

(If you start FULLBACK by way of the menu, ignore this paragraph. The options are specified for you automatically.) There are several options that may be specified when FULLBACK is executed from the A> prompt. You have to specify which drive will receive the backup, either on the command line or in response to the prompt "Enter backup drive:". Putting the backup drive letter on the command line means typing:

**fb b:**

before pressing RETURN.

When some other options are not specified, default values are used. In the example above, FULLBACK will backup all files except those with file types: BAK, COM, REL, HEX, PRN, LST, SYM, INT, SYS, OVR, OVL, XRF, IRL and \$\$\$\$. This is done to prevent the backing-up of files that are easily regenerated or that contain useless information. (Use the +A option to backup all files, regardless of type. This is done automatically when you run when you run FULLBACK through the menus.)

Before proceeding, FULLBACK will prompt for an ID code. Any eleven characters may be used, except ":", ";" and "\$". It is a good habit to use the date as all or part of the ID code.

FULLBACK will write sequentially to the backup diskettes; it will prompt for additional diskettes as they are needed. The diskettes are not written in CP/M file format, and therefore they must not be processed with standard CP/M utilities. Each diskette is labeled with the ID code (date) specified by the user and a backup diskette sequence number, to help you keep straight which diskette is which.

The CP/M DIR command, when used on a FULLBACK backup diskette, will cause the label information to be displayed, but not the list of files on the diskette.

In addition, each backup diskette should also be externally labeled, indicating the date, the ID code, the sequence number of this diskette and the number of diskettes used for the backup (for example "1/6/84 Disk 1 of 5").

FULLBACK creates a checksum file called **BACK\$DIR.SYS** on the drive being backed up. This file should be left on that drive, as it will be used later by the incremental backup program, **QUARTERBACK**. By using the checksum file, **QUARTERBACK** can tell which files have changed since the last backup. Only those files that have changed will be backed up. FULLBACK is normally executed only when a large number of files have been changed or added to the system.

You may create a special parameter file called **BACK\$PRM.SYS** to indicate which drives to use for backup and which file types are to be backed up. See the REFERENCE section of this appendix for complete description of the options available to the FULLBACK program.



## Daily backup - QUARTERBACK

While FULLBACK is normally run only when the contents of the drive have changed extensively, QUARTERBACK is intended to be run frequently. It will back up only new files or files which have been changed since the last run of QUARTERBACK or FULLBACK. When run daily, QUARTERBACK should require only one or two diskettes and should take little time. It can be run easily at the end of the day, and it can be left to run unattended. Once or twice a month, depending on how heavily the system is used, FULLBACK may be run to backup everything, and the diskettes that were used for QUARTERBACK and for the previous FULLBACK run can be recycled.

QUARTERBACK writes files on the backup diskettes in CP/M format, therefore the resulting diskettes can be read with standard CP/M utilities, like DIR and PIP.

There are two kinds of files that QUARTERBACK does not back up: files that are too large to fit on one diskette, and files that were written in CP/M random mode and have "holes". When QUARTERBACK encounters such files, it sends a message to the screen warning you that they have not been backed up. HALFBACK should be used for these kinds of files. For details on handling files with "holes", see the REFERENCE section of this appendix. None of the software provided by Morrow creates this sort of file.

Similar to FULLBACK, QUARTERBACK has a number of options. For the simplest use of QUARTERBACK log on to drive A: and type:

**qb b:**

or pick "Backup only files that have changed" from the Backfield Menu. The default options will cause all new or changed files to be backed up except those with one of these file types: BAK, COM, REL, HEX, PRN, LST, SYM, INT, SYS, OVR, OVL, XRF, IRL, and \$\$\$\$. Floppy disk drive B: will be used for the backup diskettes. As additional backup diskettes are needed, a prompt will be displayed.

Before any files are saved, a checksum is computed for each file and compared to the checksum from the last backup, as stored in the file **BACK\$DIR.SYS**. When no files have changed, no files will be backed up. After the selected files are backed up, the checksum file, **BACK\$DIR.SYS**, is updated.

As for FULLBACK, a parameter file, **BACK\$PRM.SYS**, may be created to indicate which drives to use for backup and which file types should be backed up. For a complete description of the QUARTERBACK options, see the REFERENCE section of this appendix.

### Backing up one large file - HALFBACK

Until now, there has been no convenient way to store a large file on multiple diskettes, that is, a file that is larger than 384K. With HALFBACK it is not only possible, but fast and easy to do. Log on to the drive that contains the file to be backed up. To run HALFBACK to back up a file on drive A: named "FILE1.DAT" onto floppy drive B:, type:

**HB B: FILE1.DAT**

HALFBACK will proceed in the same manner as FULLBACK, prompting as backup diskettes are needed. Each backup diskette is labeled with the file name and a sequence number. As for FULLBACK, the CP/M DIR command may be used to display the label on each diskette, but not the file names. The diskettes are not in CP/M file format. The SELECT program described below must be used to read a diskette written by HALFBACK.

### Complete restore - RESTORE

Diskettes that are created by FULLBACK can only be read by Backfield's RESTORE and SELECT programs. RESTORE restores files saved with FULLBACK to the same drive that was backed up, or to a drive with the same logical blocking and directory parameters as the original drive. The contents of the drive being restored are replaced with the files from the backup diskettes; the contents of that drive prior to the restoration are lost.

To use RESTORE, insert the Backfield Working Disk into the drive and press the RESET button. When asked, "Do you want to boot from the floppy disk?", respond:

**Y**

The process continues automatically. You are then prompted to insert volume 1 of the set of diskettes created earlier by FULLBACK. When RESTORE verifies that the correct diskette is in place, it warns you that the hard disk's present contents will be erased, and gives you the option of aborting. You may wish to abort if you can't find all of your backup disks or if you want to run QUARTERBACK one last time before proceeding.

As diskettes are required, RESTORE will display the necessary prompts. Each diskette is labeled; RESTORE will check to make sure that diskettes are loaded in the proper order.

### Restoring a single file - SELECT

The SELECT program may be used to restore a file written by either FULLBACK or HALFBACK. SELECT may be used to write the file onto any drive desired without affecting the other files on that drive. To use SELECT to restore the file "DATABASE.DAT", log on to the hard disk (A:) and type:

**SELECT B: DATABASE.DAT**

The floppy diskette in drive B: will be searched for the file. If the file is not there, an error message will be displayed. As portions of the specified file are found on the backup diskettes, they will be written to a file of the same name on the logon drive.

## REFERENCE GUIDE

This Reference Guide contains a suggested backup procedure, directions for the operation of each of the five programs in Backfield, and a complete list of the messages issued by each of the five programs.

### Backup Procedure

For disk backup to be effective, it must be done in an organized way. If a loss of data should occur, it will be difficult to make an accurate restoration of the disk data from a heap of unmarked and undated backup diskettes. Backfield writes label records on backup diskettes, and uses these labels to prevent restoration errors; nevertheless, careful operational procedures are essential.

The following operational procedure is suggested.

First, install Backfield, as described in the first sections of this appendix.

Next, analyze the day-to-day backup needs of the system, and set up a parameter file, BACK\$PRM.SYS, if needed. This file will be used by both FULLBACK and QUARTERBACK.

At fairly long intervals, say weekly, use FULLBACK to make a full backup of the drive. Use a date code as the identification code, and label the backup diskettes carefully. Store the backup diskettes in a secure place.

At more frequent intervals, say at the end of each working day, use QUARTERBACK to make an incremental backup. Label the backup diskettes clearly with the date, the diskette sequence number, and the ID code of the preceding FULLBACK backup. Store them with the FULLBACK backup diskettes.

When a new FULLBACK backup is done, save the previous FULLBACK backup diskettes together with the subsequent QUARTERBACK backup diskettes, as one backup set. This provides an additional level of protection; should the most recent FULLBACK backup be lost, the previous FULLBACK plus QUARTERBACK diskettes can be used to restore to the point at which the lost FULLBACK was done. Backup diskettes from backups prior to the previous FULLBACK plus QUARTERBACK set can be recycled for subsequent backup use.

## FULLBACK Operation

The function of FULLBACK is to back up a CP/M logical drive to floppies. It reads the drive sector-by-sector in physical sequential order, copying all sectors that belong to files which have been selected by the file-selection option described below. Files are selected regardless of user number. FULLBACK writes a checksum file on the drive being backed up, for later use by the incremental backup program, QUARTERBACK. The backup floppies are written in a format not readable by CP/M; the special restore programs in Backfield are required to read them.

### Program files

Three program files are required to run FULLBACK. They are: FB.COM, BSETUP.OVL and BLARGE.OVL. The overlay files (those of type OVL) must be present on the hard disk. A fourth file, the parameter file BACK\$PRM.SYS, may also be present on the hard disk.

### The checksum file

When FULLBACK has completed backing up the files, it writes a checksum file, BACK\$DIR.SYS, to the drive backed up. This file contains, for each file backed up: the file name, the file type, the user number, the number of sectors in the file, and the checksum (a CRC calculation). The checksum file is an ASCII text file, and it can be typed and edited; its format must not be changed. The checksums are calculated with a CRC algorithm which produces an almost-unique 16-bit number for each file. The chances are 1 in 65536 that the algorithm will calculate the same checksum for two different files.

### Backup diskettes

The diskettes used for backup need not be blank. FULLBACK will overwrite them. The diskettes must be properly formatted, however, and if they contain information, it will be erased. If a bad sector is encountered on any diskette during a FULLBACK run, the run is aborted, and the backup must be run again from the beginning.

FULLBACK writes the backup diskettes sequentially, sector by sector, starting with the first track after the CP/M reserved system tracks. The first sector that it writes to each diskette is a "label" sector; it contains the name "FULLBACK", the disk sequence number (starting with "001"), the backup identification code, the types list, parameters of the drive backed up and parameters of the backup drives. Following the label sector, the data is written sequentially, in the order in which it occurs on the drive being backed up. This causes the backup to be much faster than the traditional file by file copy.

It is essential to understand that the backup diskettes written by FULLBACK cannot be read or written by standard CP/M utilities. If you write to a FULLBACK backup diskette with CP/M, the system will attempt to interpret backup data as a CP/M directory, and backup data will be overwritten, destroying the backup. You can, however, issue the CP/M command "DIR" on a FULLBACK backup diskette; on diskette 001 of a backup set, DIR

## FULLBACK Operation

will display the name "FULLBACK", the diskette number, and the identification code. On diskettes other than number 001, the name, number, and identification code will also be displayed, but meaningless results will occur as CP/M attempts to interpret the following backup data as a directory.

### Options

FULLBACK has several options, which are specified either on the command line or in the parameter file:

- o The \$ option causes FULLBACK to compute the checksum file without backing up any files.
- o The +A option causes all files to be backed up, regardless of file type.
- o The +B option causes only files specified in the types list to be backed up. (The "types list" is a list of CP/M file types; its specification is described below.)
- o The +O ("oh", not zero) option causes all files except those in the types list to be backed up. Files of the type "\$\$\$", which are CP/M temporary files, are never backed up. This is the default option.

### Backup drives

The backup drives are the CP/M logical drives in which the backup diskettes will be placed. A backup drive is specified by a "drive code", a letter (upper or lower case) immediately followed by a colon. The letter must refer to a CP/M logical drive that exists on the system. The backup drives must be different from the drive being backed up.

NOTE: With the Micro Decision, the floppy drive is drive B: when you boot from the hard disk (normal) and drive A: when you boot from the CP/M floppy diskette (unusual).

### The backup ID code

FULLBACK requires that a 1 to 11 character identification code be given for each backup run. This code must not contain the characters ":", "+", or "\$". FULLBACK will write the code in the label sector of each backup diskette. It is recommended that the identification code be different from any previously used backup identification codes. A suggestion is to construct the identification code from today's date and the current time, like "2/13/84-5PM".

### Parameters

For FULLBACK to run, parameters are required to indicate: (1) the backup drives, (2) the options, (3) the types list, and (4) the ID code of this backup. Parameters are specified in four ways: (1) by default, (2) in the parameter file, (3) on the command line, and (4) in response to prompts during the backup run.

Default parameters

Default parameter values are coded into FULLBACK. If a parameter is not specified in another way, the default value is used. The default \$ option is blank -- back up the files, in addition to creating the checksum file. The default file selection option is "+O" -- omit files with types in the types list. The default types list is: "BAK, COM, REL, HEX, PRN, LST, SYM, INT, SYS, OVR, OVL, XRF, IRL". There are no default backup drives.

The parameter file

The parameter file is a file named BACK\$PRM.SYS which resides on the drive being backed up. The parameter file is optional; if it exists, FULLBACK will read it and use the parameter values found in it. These values will override default parameter values.

You create the file BACK\$PRM.SYS yourself with a text editor like NewWord. The parameter file consists of one or two lines of normal text, and must be given the name "BACK\$PRM.SYS". The first line contains a list of zero or more drive codes, and zero or more options. They may be in any order. The first line of the parameter file may also be blank. The second line of the parameter file contains the types list, a list of zero to 20 type codes. Each type code consists of four characters; the fourth character is always a blank. The first three characters of a type code should specify a CP/M file type. Capital letters, digits, blanks or other characters allowed in CP/M files should be used. This line may be omitted if it is empty.

**EXAMPLE:**

Here are the contents of a sample BACK\$PRM.SYS file:

```
B: +B
DOC DTA BAK
```

This means "use drive B: to contain the backups; copy only the file types on the second line: documents, data, and backup versions."

Backfield programs do not check the parameter file for correctness of format. It is very important to insure that it is correct.

The command line

Like many CP/M programs, FULLBACK is run by typing the program name followed by a command line and a carriage return. The FULLBACK command line may be empty or it may contain any or all of the following parameters, in any order: backup drive codes, options, a backup identification code. Parameters specified in the command line take precedence over a default value of that parameter or a value given in the parameter file.

## FULLBACK Operation

### EXAMPLE:

A full command line for FULLBACK might look like:

```
FB B: +O 3/16/84
```

meaning, "Back up everything onto floppies in drive B:, copy all files except those in the default types list (COM, BAK, etc.), and label the diskettes with the date of March 16."

### Prompts

If a required parameter is missing, or if a parameter is specified incorrectly, FULLBACK will display a prompt for the correct value to be entered.

### Overlay files

FULLBACK uses the overlay files BSETUP.OVL and BLARGE.OVL.

### User numbers

FULLBACK must be run in user 0. All selected files, under all user numbers, are backed up by FULLBACK in a single pass. The user numbers are retained with the files, so the Backfield restore programs can restore a file to the correct user number. FB.COM is normally always present in user 0 of drive A: on the Micro Decision.

### Restrictions and limitations

In order to optimize backup speed, FULLBACK maintains a backup list in memory. Unusually large directories - in excess of approximately 700 files - may cause FULLBACK to fail due to memory overflow.

### Running FULLBACK

FULLBACK is run as follows:

1. The FULLBACK program files must be present on the hard disk.
2. If a parameter file is desired, it must be on the hard disk in user area 0.
3. Be sure you have enough good diskettes for the entire backup (approximately 3 diskettes per megabyte of space used on the hard disk. Use the SHOW command to find out how much space is in use.) Place the first diskette in the backup drive.
4. Log in to the drive to be backed up (A:, assuming you booted from the hard disk.) If you have logged into a different user number, change to user 0 by typing "user 0".
5. Type: FB [command line] [return]

6. Respond to any prompts that occur.
7. As each diskette is filled, remove it and insert another diskette. Label the filled diskette correctly. If you fail to replace a diskette when required, you will be prompted to do so.
8. Continue until the message "Backup complete" appears.

#### Restoring files backed up by FULLBACK

Use RESTORE to completely restore a drive from diskettes written by FULLBACK; use SELECT to restore a single file.

#### **Messages issued by FULLBACK**

##### Informational messages:

FULLBACK version [number] Copyright (C) 1982 Audio Light, Inc.  
This message is displayed when FULLBACK begins.

Enter backup drives:

If the backup drives are not given in the command line or in the parameter file, they are asked for here. Enter all the backup drive codes, a letter followed by a colon for each; then key a carriage-return. (Normally "B:" on the Micro Decision.)

Enter date or other ID code.

FULLBACK requires an ID code, which it writes in the first sector of each backup diskette. The code must be 1 to 11 characters long, and it must not contain the characters ":", "+", or "\$". If the ID code is not given in the command line, it is asked for here. Enter a valid ID code, followed by a carriage-return.

Backup drives: [drive codes]

FULLBACK will backup files to diskettes in the named drives, in alphabetical order.

Backing up these these types:

[types list]

FULLBACK will back up only files having the named types.

Omitting these types:

[types list]

FULLBACK will back up only files having types other than the named types.



## FULLBACK Messages

Reading track: [track numbers]

Track numbers are displayed as FULLBACK proceeds sequentially through the drive being backed up. This provides a graphic display of the program's progress.

Drive [drive code] full.

Backing up to drive [drive code], disk number [number].

FULLBACK has filled the diskette in the first drive named. It will continue writing on the diskette in the second drive named. (Does not apply to computers with single floppy drives.)

Check diskette and hit any key when ready.

The diskette in the drive just named has the ID code for the current backup written in its first sector. The diskette may be an earlier diskette in the backup set for the current backup.

Check the diskette and be sure you want it overwritten. When a correct diskette is in the drive, hit any key, and FULLBACK will write on the diskette.

Alternately, you may key ctrl-C (hold down the "CTRL" key and depress the "C" key) to abort the program run.

Backup complete.

Calculation complete.

One of these messages is displayed after FULLBACK has completed, just before it exits. If FULLBACK terminates without this message, it has not completed successfully.

### Fatal error messages:

Fatal error: CP/M Version 2.2/3.0 required.

FULLBACK runs only under CP/M version 2.2 or 3.0.

Fatal error: overlay file missing, [overlay file name]

The named overlay file was not found under user 0, neither on the logon drive nor on drive A:.

Fatal error: bad parameter file.

The parameter file, BACK\$PRM.SYS, is not in the correct format. Edit and correct the file BACK\$PRM.SYS.

Fatal error: no files satisfy types list.

If the "backup" option was specified, no files were found with types in the types list. If the "omit" option was specified, no files were found with types not in the types list.

Fatal error: insufficient space for scratch files.

There is insufficient space in either the directory or the data area of the drive being backed up for scratch files. Erase some files and run the program again.

Fatal error: invalid "+" switch specification.

You must specify exactly one of the file selection options, "+A", "+B" or "+O".

Fatal error: maximum size of types list is 20.

The parameter file, BACK\$PRM.SYS, contains more than 20 types, or the file is not in the correct format. Edit and correct the file BACK\$PRM.SYS.

Fatal error: bad program file.

One of the .COM or .OVL files used by Backfield is the wrong version, or has been corrupted. Repeat Backfield installation procedure and re-run the program.

Fatal error: out of memory - directory too large.

The drive being backed up has too large a directory for the current version of Backfield to handle. Erase unnecessary files from the drive and try the program again.

Fatal error: no drives [drive codes]

The drives named do not exist on the system. The backup drives list - either in the parameter file BACK\$PRM.SYS or on the command line - may be in incorrect format. Correct the backup drives list and run the program again.

Fatal error: Backup aborted by ctrl-C.

Following a "Check diskette" message, the operator keyed ctrl-C.

Fatal error: scratch file missing.

Fatal error: scratch file has data in incorrect format.

Fatal error: scratch file has incorrect data.

Fatal error: scratch file has incorrect number of records.

A scratch file (of type "\$\$\$") written during an earlier phase of the program cannot be found by the current phase, or the scratch file is incorrect. Erase all files of type "\$\$\$" and run the program again. If the error persists, check for an operational error or a hardware error.

Conversion error [number], [file (file name)]

A bad data item was encountered. If a file name is given, the datum was read from the file. In this case, the cause may be a bad disk, or a hardware fault.

Fatal write error, drive [drive code], track [track number], sector [sector number].

An unrecoverable write error has occurred in attempting to write to the drive named. Either the diskette is damaged, or there is a hardware fault. Replace the diskette and run the program again. It is important to use good backup diskettes. Standard CP/M does not allow a program to recover from write errors.

## FULLBACK Messages

### Non-fatal error messages:

Invalid backup drives: [drive codes]

Re-enter drives:

An illegal backup drive has been specified or the one specified is the same as the drive to be backed up. You must be logged on to the drive to be backed up when you run FULLBACK, and the backup drives must not include the drive to be backed up. Enter all the backup drive codes, a letter and a colon for each, followed by a carriage-return. This error message will be repeated until a correct set of backup drives has been entered.

Backup diskette is bad. Replace it and hit any key when ready.

The first directory sector on the diskette in the drive just named is bad. Replace the diskette and hit any key, and the program will correctly continue with the new diskette. It is important to use good backup diskettes.

Read error, drive [drive code], track [track number], sector [sector number].  
The sector has been backed up as all blanks.

An unrecoverable read error occurred on the named drive, the drive being backed up. A sector on the drive is faulty. FULLBACK will ignore the data and write an all-blank sector to the backup drive.

No room for file BACK\$DIR.SYS

There is insufficient space on the drive being backed up for the checksum file, BACK\$DIR.SYS. The checksum file is not written, but the backup is correct. Erase unnecessary files from the drive being backed up. Then the missing checksum file can be created by running "FB \$".

## QUARTERBACK Operation

QUARTERBACK is an "incremental" backup program; its main function is to back up files that have been changed or added since the last backup. QUARTERBACK decides whether or not to back up a file by calculating a checksum for the file, and comparing it with the checksum for that file found in the checksum file BACK\$DIR.SYS.

QUARTERBACK does its backup file-by-file, and writes its output in standard CP/M file format. Backed up files are written under the same user number as the original file.

QUARTERBACK can be used to do a full backup in CP/M format by erasing the file BACK\$DIR.SYS before running the backup. Since QUARTERBACK writes its output file-by-file, it will take much longer than FULLBACK to do the backup, but its output will be in standard CP/M format.

### The program files

Four program files are required to run QUARTERBACK. They are: QB.COM, BSETUP.OVL, BLARGE.OVL, and QBOVLY.OVL. BSETUP.OVL and BLARGE.OVL are the same files used by FULLBACK. The overlay files must reside in user 0 of drive A:, which is normal for the Micro Decision. The parameter file BACK\$PRM.SYS may also be present.

### The checksum file

QUARTERBACK uses the checksum file BACK\$DIR.SYS originally written by FULLBACK. After backing up the files it selects, it writes the new checksums in the checksum file. If no BACK\$DIR.SYS file exists on the drive being backed up, QUARTERBACK will calculate checksums for all files (subject to the file selection option described below) and create a BACK\$DIR.SYS file.

### The backup diskettes

Unlike FULLBACK, QUARTERBACK writes its backup diskettes in standard CP/M file format. It does not overwrite the backup diskettes; rather it adds files, erasing only files that have the same name as a file it is adding. It will fill a backup diskette, and then proceed to write to the next backup diskette, until all the files to be backed up are written. Like FULLBACK, QUARTERBACK will abort if it encounters a bad sector on any backup diskette.

QUARTERBACK writes no special label on the backup diskettes. Since its output is in standard CP/M format, DIR or any directory utility can be used to determine the contents of a QUARTERBACK diskette.

## QUARTERBACK Operation

### Options

QUARTERBACK has two options: the first selects files which are candidates for backing up, similar to FULLBACK's file selection option; the second causes the listing of the names of files which have changed since the last backup, without backing up the files.

- o To only list the names of files which have changed use \$ on the command line or in the parameter file. When the \$ option is used no files will be backed up.
- o The option +A causes all files to be backed up, regardless of their types.
- o The option +B causes all files with file types specified in the types list to be backed up.
- o The option +O causes all files except those specified in the types list to be backed up.

### Backup drives

The backup drives for QUARTERBACK are defined in the same way as the backup drives for FULLBACK, that is, on the command line, in a parameter file BACK\$PRM.SYS, or in response to a prompt that appears after you start the program.

### Parameters

For QUARTERBACK to run, parameters are required to indicate: (1) the backup drives, (2) the values of the options selected, and (3) the types list.

Parameters are specified in the same manner as parameters for FULLBACK, except that QUARTERBACK uses no backup identification code.

### Overlay files

QUARTERBACK uses the overlay file QBOVLY.OVL, in addition to the same overlay files used by FULLBACK.

### User numbers

QUARTERBACK must be run in user 0. All selected files, under all user numbers, are backed up. Each file is written on the backup diskettes with the same user number it has on the disk being backed up.

### Restrictions and limitations

QUARTERBACK has the same directory size limitations as FULLBACK.

QUARTERBACK could fail to detect that a file has changed, since the probability that two different files will have the same checksum is one in 65536. The chances are even less, however, that two different files with

the same name will have the same checksum.

QUARTERBACK does not back up files that exceed 384K or files that have been written in random mode.

### Running QUARTERBACK

QUARTERBACK is run as follows:

1. The QUARTERBACK program files must have been installed correctly.
2. If a parameter file is desired, it must be on the drive to be backed up (usually A:, the hard disk), under user 0.
3. Be sure you have enough good diskettes for the entire backup. A test for how many diskettes would be to run QUARTERBACK with the \$ option to obtain a list of changed files; then use DIR [FULL] to gather their sizes. Place a diskette in the floppy drive.
4. Log in to the drive to be backed up and set the user number to 0 by typing "user 0" and pressing RETURN.
5. Type: A:QB [command line] [carriage-return]
6. Respond to any prompts that occur.
7. As each diskette is filled, remove it and insert another diskette. Label the filled diskette clearly with the drive backed up and the backup identification code of the last FULLBACK backup. After the first pass through the backup drives, QUARTERBACK will prompt to change the backup diskette.
8. Continue until the message "Backup complete" appears.

### Restoring files backed up by QUARTERBACK

QUARTERBACK's backup diskettes have been written in standard CP/M format. To restore a file, set the proper user number and copy the file with PIP or another file copy utility.

**Messages issued by QUARTERBACK**

Informational messages:

QUARTERBACK version [number] Copyright (C) 1982 Audio Light, Inc.

This message is displayed when QUARTERBACK begins.

Enter backup drives:

If the backup drives are not given in the command line or in the parameter file, they are asked for here. Enter all the backup drive codes, a letter followed by a colon for each; then hit a return. ("B:" is normal for the Micro Decision.)

Backup drives: [drive codes]

QUARTERBACK will backup files to diskettes in the named drives, in alphabetical order.

Backing up these these types:

[types list]

QUARTERBACK will back up only files having the named types.

Omitting these types:

[types list]

QUARTERBACK will back up only files having types other than the named types.

Reading track: [track numbers]

Track numbers are displayed as QUARTERBACK proceeds sequentially through the drive to be backed up, searching for files which have been changed or added since the last backup. This gives a graphic display of the program's progress.

[number] files to be backed up.

QUARTERBACK announces the number of files that it will back up.

[number] files have been changed:

If QUARTERBACK was run with the "\$" switch, it will announce the number of files that have changed since the last backup, and it will list the file names.

Diskette space available: [number] sectors, [number] directory slots.

QUARTERBACK states the storage space available on the diskette in the drive just named.

Backing up files:

user [user number] [file name] [number] sectors.

...

user [user number] [file name] [number] sectors.

As QUARTERBACK backs up a file, it states the name of the file when it begins backing it up, and the number of sectors in the file when it completes backing it up.

not backed up - random file with "holes".

After the file name of a file to be backed up is listed, this message appears if the file is found to be a CP/M random file with "holes". QUARTERBACK cannot back up such a file. Use HALFBACK for the file.

not backed up - too large for one output diskette.

After the file name of a file to be backed up is listed, this message appears if the file is found to be too large to fit on one backup diskette. QUARTERBACK cannot back up such a file. Use HALFBACK for the file.

Drive [drive code] full.

Continuing backup on drive [drive code]

QUARTERBACK has filled the diskette in the first drive named. It will continue writing on the diskette in the second drive named.

Hit any key when ready.

If QUARTERBACK has already written to the drive just named for continuing the backup, it will wait until you hit any key before continuing. This gives you the opportunity to be sure that the diskette in the drive is not the same one written on earlier in this backup run.

Backup complete.

Calculation complete.

One of these messages is displayed after QUARTERBACK has completed, just before it exits. If QUARTERBACK terminates without this message, it has not completed successfully.

Fatal error messages:

Fatal error: CP/M Version 2.2/3.0 required.

QUARTERBACK runs only under CP/M version 2.2 or 3.0.

Fatal error: overlay file missing, [overlay file name]

The named overlay file was not found under user 0, neither on the logon drive nor on drive A:.

Fatal error: bad program file.

One of the .COM or .OVL files used by Backfield is the wrong version, or has been corrupted. Repeat Backfield installation procedure and re-run the program.

Fatal error: out of memory - directory too large.

The drive being backed up has too large a directory for the current version of Backfield to handle. Erase unnecessary files from the drive and try the program again.

Fatal error: bad parameter file.

The parameter file, BACK\$PRM.SYS, is not in correct format. Edit and correct the file BACK\$PRM.SYS.



## QUARTERBACK Messages

Fatal error: no files satisfy types list.

If the "backup" option was specified, no files were found with types in the types list. If the "omit" option was specified, no files were found with types not in the types list.

Fatal error: insufficient space for scratch files.

Fatal error: no directory space for scratch file.

There is insufficient space in either the directory or the data area of the drive being backed up for scratch files. Erase some files and run the program again.

Fatal error: invalid "+" switch specification.

You must specify exactly one of the file selection options: "+A", "+B" or "+O".

Fatal error: maximum size of types list is 20.

The parameter file, BACK\$PRM.SYS, contains more than 20 types, or the file is not in the correct format. Edit and correct the file BACK\$PRM.SYS.

Fatal error: no drives [drive codes]

The drives named do not exist on the system. The backup drives list - either in the parameter file BACK\$PRM.SYS or on the command line - may be in incorrect format. Correct the backup drives list and run the program again.

Fatal error: scratch file missing.

Fatal error: scratch file has data in incorrect format.

Fatal error: scratch file has incorrect data.

Fatal error: scratch file has incorrect number of records.

A scratch file (of type "\$\$\$") written during an earlier phase of the program cannot be found by the current phase, or the scratch file is incorrect. Erase all files of type "\$\$\$" and run the program again. If the error persists, check for an operational error, or a hardware error.

Fatal error: format error in file BACK\$DIR.SYS.

The checksum file BACK\$DIR.SYS, written by an earlier run of FULLBACK, HALFBACK or QUARTERBACK, contains data in an incorrect format. The file may have been edited or modified by a program since it was written.

The safest procedure is to run FULLBACK, saving all files while creating a new checksum file.

Conversion error [number], [file (file name)]

A bad data item was encountered. If a file name is given, the datum was read from the file. In this case, the cause may be a bad disk, or a hardware fault.

Fatal error: file open error: [file name]

The file was found in the directory of the disk being backed up, but now it cannot be opened. This may be due to a bad sector on the drive being read. QUARTERBACK will abort.

Correct the bad file on the disk being backed up and repeat the run of QUARTERBACK.

Fatal error: file create error: [file name]

The file cannot be created on the backup drive. This may be due to a faulty diskette in the backup drive. QUARTERBACK will abort.

Repeat the run of QUARTERBACK, using good backup diskettes.

Non-fatal error messages:

Invalid backup drives: [drive codes]

Re-enter drives:

Either an illegal backup drive code has been given, or one given is the same as the drive to be backed up. You must be logged on to the drive to be backed up when you run QUARTERBACK, and the backup drives must be other than the drive to be backed up. Enter all the backup drive codes, a letter and a colon for each; then type return. This error message will be repeated until a correct set of backup drives has been entered.

Backup diskette is bad. Replace it and hit any key when ready.

The first directory sector on the diskette in the drive just named is bad. Replace the diskette and hit any key, and the program will correctly continue with the new diskette. It is important to use good backup diskettes.

No room for file BACK\$DIR.SYS

There is insufficient space on the drive being backed up for the checksum file, BACK\$DIR.SYS. The checksum file is not written. No backup is done. Erase unnecessary files from the drive being backed up and run QUARTERBACK again.

Error: backup file incomplete.

The file just named was not completely written on the backup diskette. This may be due to a faulty backup diskette. QUARTERBACK will complete its backup run; when it is done, you may run QUARTERBACK again to backup this file. Check the backup diskette for bad sectors.

## HALFBACK Operation

The function of HALFBACK is to back up a single large file onto floppies. HALFBACK can handle a CP/M random file that has allocation "holes" as well as a sequential file. It calculates a checksum for the file and adds it to the checksum file BACK\$DIR.SYS. It writes the backup floppies in the same format that FULLBACK does, a format not readable by CP/M. The program SELECT is required to read floppies written by HALFBACK.

### The program files

Three program files are required to run HALFBACK. They are: HB.COM, BSETUP.OVL and BLARGE.OVL. BSETUP.OVL and BLARGE.OVL are the same files used by FULLBACK. The overlay files must reside on drive A: of the system. The parameter file BACK\$PRM.SYS may also be present.

### The checksum file

HALFBACK adds the checksum of the file it has backed up to the checksum file, BACK\$DIR.SYS.

### The backup diskettes

The requirements for HALFBACK's backup diskettes are the same as for FULLBACK. HALFBACK writes a label sector like FULLBACK, except that it contains the name "HALFBACK". HALFBACK writes the name of the file it is backing up in the label sector in place of FULLBACK's backup identification code.

Similar to FULLBACK, HALFBACK's backup diskettes must not be read or written by standard CP/M utilities. They need not be blank, but they must be formatted. Any data on the diskette will be overwritten.

### Options

HALFBACK has no options.

### Backup drives

The backup drives for HALFBACK are defined the same as the backup drives for FULLBACK.

### Parameters

HALFBACK requires parameters to indicate the backup drives and the name and user number of the file to be backed up. The backup drives may be specified in the parameter file or in the command line. The file name and user number may be given in the command line. If no user number is given, 0 is assumed. If a required parameter is missing, HALFBACK will prompt for it.

Running HALFBACK

HALFBACK is run as follows:

1. The HALFBACK program files must have been installed correctly.
2. If a parameter file is desired, it must be on the drive to be backed up under user 0.
3. Be sure you have enough good diskettes for the entire backup. Run SHOW on the file to check its size; you'll need one diskette per 380K of space in the file. Place a diskette in the backup drive.
4. Log in to the drive to be backed up and set the user number to 0 by typing "user 0" and pressing RETURN.
5. Type: HB [command line] [return]
6. Respond to any prompts that occur.
7. As each diskette is filled, remove it and insert another diskette. Label the filled diskette. If you do not replace a diskette when required, you will be prompted to do so.
8. Continue until the message "Backup complete" appears.

Restoring a file backed up by HALFBACK

Use SELECT to restore the single file backed up by HALFBACK.

**Messages Issued by HALFBACK**Informational messages:

HALFBACK version [number] Copyright (C) 1982 Audio Light, Inc.

This message is displayed when HALFBACK begins.

Enter backup drives:

If the backup drives are not given in the command line or in the parameter file, they are asked for here. Enter all the backup drive codes, a letter followed by a colon for each; then key a carriage-return. ("B:" is normal for the Micro Decision.)

Enter name of file to be backed up.

If the name of the file to be backed up is not given on the command line, it is asked for here. Enter a file name in CP/M format, in upper or lower case, without a drive code. If the user number of the file is not 0, enter a slash (/) followed by the user number on the same line as the file name. Example - SAMPLE.DOC /1

## HALFBACK Operation

Backup drives: [drive codes]

HALFBACK will backup files to diskettes in the named drives, in alphabetical order.

Backing up file [file name] ;[user number]

HALFBACK will back up the named file from the named user area.

Reading track: [track numbers]

Track numbers are displayed as HALFBACK proceeds sequentially through the drive being backed up. This gives a graphic display of the program's progress.

Drive [drive code] full.

Backing up to drive [drive code], disk number [number].

HALFBACK has filled the diskette in the first drive named. It will continue writing on the diskette in the second drive named.

Check diskette and hit any key when ready.

The diskette in the drive just named has the ID code for the current backup written in its first sector. The diskette may be an earlier diskette in the backup set for the current backup.

Check the diskette and be sure you want it overwritten. When a correct diskette is in the drive, hit any key, and HALFBACK will write on the diskette.

Alternately, you may key ctrl-C (hold down the "CTRL" key and depress the "C" key) to abort the program run.

Backup complete.

This message is displayed after HALFBACK has completed, just before it exits. If HALFBACK terminates without this message, it has not completed successfully.

### Fatal error messages:

Fatal error: CP/M Version 2.2/3.0 required.

HALFBACK runs only under CP/M version 2.2 or 3.0.

Fatal error: overlay file missing, [overlay file name]

The named overlay file was not found under user 0, neither on the logon drive nor on drive A:

Fatal error: bad program file.

One of the .COM or .OVL files used by Backfield is the wrong version, or has been corrupted. Repeat Backfield installation procedure and re-run the program.

Fatal error: invalid user number: [number]

The user number is not an integer in the range 0-15.

Fatal error: bad parameter file.

The parameter file, BACK\$PRM.SYS, is not in correct format. Edit and correct the file BACK\$PRM.SYS.

Fatal error: insufficient space for scratch files.

There is insufficient space in either the directory or the data area of the drive being backed up for scratch files. Erase some files and run the program again.

Fatal error: no drives [drive codes]

The drives named do not exist on the system. The backup drives list - either in the parameter file BACK\$PRM.SYS or on the command line - may be in incorrect format. Correct the backup drives list and run the program again.

Backup aborted by ctrl-C.

Following a "Check diskette" message, the operator keyed ctrl-C.

Fatal error: scratch file missing.

Fatal error: scratch file has data in incorrect format.

Fatal error: scratch file has incorrect data.

Fatal error: scratch file has incorrect number of records.

A scratch file (of type "\$\$\$") written during an earlier phase of the program cannot be found by the current phase, or the scratch file is incorrect. Erase all files of type "\$\$\$" and re-run the program from the beginning. If the error persists, check for an operational error, or a hardware error.

Conversion error [number], [file (file name)]

A bad data item was encountered. If a file name is given, the datum was read from the file. In this case, the cause may be a bad disk, or a hardware fault.

Fatal write error, drive [drive code], track [track number], sector [sector number].

An unrecoverable write error has occurred in attempting to write to the drive named. Either the diskette is damaged, or there is a hardware fault. Replace the diskette and run the program again. It is important to use good backup diskettes. Standard CP/M does not allow a program to recover from write errors.

#### Non-fatal error messages:

Invalid backup drives: [drive codes]

Re-enter drives:

An illegal drive has been specified or, one of the backup drives is the same as the drive to be backed up. You must be logged on to the drive to be backed up when you run HALFBACK, and the backup drives must not include the drive to be backed up. Enter all the backup drive codes, a letter and a colon for each; then type return. This error message will be repeated until a correct set of backup drives has been entered.

## HALFBACK Operation

Backup diskette is bad. Replace it and hit any key when ready.

The first directory sector on the diskette in the drive just named is bad. Replace the diskette and hit any key, and the program will correctly continue with the new diskette. It is important to use good backup diskettes.

Read error, drive [drive code], track [track number], sector [sector number]. The sector has been backed up as all blanks.

An unrecoverable read error occurred on the named drive, the drive being backed up. A sector on the drive is faulty. HALFBACK will ignore the data and write an all-blank sector to the backup drive.

No room for file BACK\$DIR.SYS

There is insufficient space on the drive being backed up for the checksum file, BACK\$DIR.SYS. The checksum file is not written, but the backup is correct. Erase unnecessary files from the drive being backed up. Then the missing checksum file can be created by running "FB \$"

## RESTORE Operation

The function of the RESTORE program is to completely restore a drive from a backup done by FULLBACK. The current contents of the drive being restored are destroyed, and replaced with the files from the FULLBACK backup diskettes. It may be necessary to follow RESTORE by using PIP (or the Utility Menu equivalent "Copy a file or files") to restore additional files from QUARTERBACK backup diskettes.

### The program files

RESTORE requires only one file, RESTORE.COM.

### Parameters

The only parameters to RESTORE are backup drive codes, which may be placed in the command line, or may be given in response to a prompt. As for all programs in Backfield, a drive code is a letter (upper or lower case) immediately followed by a colon. "B:" is normal for the Micro Decision.

### User numbers

RESTORE always runs in user 0. Files are restored to the user numbers from which they were backed up.

### Running RESTORE

There are two situations where you may need to run RESTORE: The first is when your software all seems to run just fine, but your data base or text files have been corrupted. The second is when your software won't run, or you can't even boot from the hard disk.

Either situation requires starting over from scratch by reformatting your hard disk, thus erasing all programs and data from it. Then you'll use your FULLBACK and QUARTERBACK diskettes to restore your data and program files. This process is initiated by booting from the Backfield Working Disk that you made when first setting up your system.

It is worthwhile to try to avoid reformatting the hard disk. Therefore you may wish to boot from the CP/M Distribution diskette and use PIP to restore programs that don't work right. Then use SELECT or PIP if necessary to get your data back. Don't go through the boot-from-the-Backfield-Working-Disk process, as reformatting and RESTORE are automatically run.

The steps below assume you created your Backfield Working Diskette as part of setting up your system.

1. Insert the Backfield Working Diskette into the floppy drive and press the RESET button.
2. When asked whether you want to boot from the floppy drive, respond Y.
3. RESTORE will guide you through inserting the diskettes created previously by FULLBACK. Continue until you see the message "Restore complete."

Be aware that if you've lost or damaged your Backfield Working Diskette, or if you failed to prepare it when setting up the system, you can still run RESTORE, provided the program RESTORE.COM is present on the hard disk and the hard disk is addressable. These conditions will be met if you've reformatted the hard disk and reloaded all of the software. In this case, log onto drive A: and type RESTORE (RETURN). Name B: as the backup drive.

You now have a system that is restored to its condition as of the last FULLBACK. To recover files backed up by QUARTERBACK, use option 7 on the Backfield Options Menu, or use PIP or to get the same result. Option 7 pips every file in every user number from the QUARTERBACK diskettes onto the hard disk.



**Messages Issued by RESTORE**

Informational messages

THE BACKFIELD RESTORE version [version number]. Copyright (C) 1982, Audio Light, Inc.

This message is displayed when RESTORE begins.

Enter backup drives:

If the backup drives are not given in the command line, they are asked for here. Enter all the backup drive codes, each a letter followed by a colon. ("B:" is normal for Micro Decisions.)

Restoring drive [drive code] from backup with ID code [backup ID code].

Backup drives: [drive codes]

CAUTION!!! present contents of drive [drive code] will be destroyed.

Ready? (Y/N)

The purpose of this message is to prevent a catastrophic operational error. Be sure that the restoration RESTORE is about to do is correct, then type "Y" (upper or lower case).

If you key anything other than "Y", RESTORE will abort.

Writing track: [track numbers]

Track numbers are displayed as RESTORE proceeds sequentially through the drive being restored. This is done to show the progress of the program.

Drive [drive code] finished.

Continuing restore from drive [drive code]

RESTORE has completed reading the backup diskette in the first drive named. It will continue reading the diskette in the second drive named. No operator action is necessary.

Done restoring.

This message is displayed after RESTORE has completed, just before it exits. If RESTORE terminates without this message, it has not completed successfully.

Fatal error messages:

Fatal error: wrong restore program. Use "RESTOREL". [or: Use "RESTORES".]  
The wrong restore program was run. First, be sure you are logged on to the drive you wish to restore. If so, use the other RESTORE program. (Note: Morrow is shipping only RESTOREL.COM, renamed RESTORE.COM. This message should never appear.)

Fatal error: backup drive same as source drive.

A drive specified in the command line is the same as the current logon drive. You must be logged on to the drive you wish to restore when you run the RESTORE program. The backup drives must be other than the drive being restored.

Fatal error: drive to be restored has incorrect block size.

Fatal error: drive to be restored has incorrect capacity.

Fatal error: drive to be restored has incorrect directory size.

These three errors may occur when the drive to be restored is not identical to the drive that was backed up. You may be logged in to the wrong drive or, you may be using the wrong backup diskettes.

The following parameters must be the same for the drive to be restored from a FULLBACK backup, and the drive that was backed up: allocation block size, extent mask, number of directory blocks; also the maximum block number for both drives must be either less than 256 or greater than 255.

Fatal error: first backup diskette has inconsistent parameters.

The data on the backup diskette has been damaged. It may have been written on by another program. Check it by displaying its directory with the CP/M DIR command; if anything other than "FULLBACK 001 {back-up ID code}" appears, the diskette has been overwritten.

Fatal error: RESTORE aborted by ctrl-C.

Following a "Wrong backup diskette" message, the operator keyed ctrl-C.

Fatal read error, drive [drive code], track [track number], sector [sector number].

An unrecoverable read error has occurred in attempting to read the backup diskette in the drive named. Either the diskette is damaged, or there is a hardware fault. RESTORE cannot recover from this type of error.

Fatal write error, drive [drive code], track [track number], sector [sector number].

An unrecoverable write error has occurred in attempting to write to the drive named. Either the disk is damaged, or there is a hardware fault. RESTORE cannot recover from this type of error.

#### Non-fatal error messages:

Wrong backup diskette in drive [drive code] [program name] [diskette number] [backup ID code]

Install correct diskette and hit any key.

The diskette in the drive named is not the backup diskette required. It may be the wrong diskette from the backup set (the set is out of order); it may be a diskette from a different backup set; it may not be a FULLBACK backup diskette.

Replace the diskette with the correct one and hit any key. The error message will be repeated until the correct diskette is in place.

## RESTORE Messages

Alternately, you may key ctrl-C (hold down the "CTRL" key and depress the "C" key) to abort the program run.

### SELECT operation

The function of the SELECT program is to restore a single file from a backup done by FULLBACK or HALFBACK. The current contents of the drive being restored are not changed, except that any file with the same name and user number as the one being restored is deleted and replaced with the restored one.

#### The program files

SELECT requires only one file, SELECT.COM.

#### Parameters

The parameters to SELECT are the backup drive codes and the user number and name of the file to be restored. The parameters may be placed in the command line, or they may be given in response to prompts. As for all programs in Backfield, a drive code is a letter (upper or lower case) immediately followed by a colon. The user number of the file being restored is specified by placing the number immediately following a slash (/) in the command line or in the response to a prompt. If no user number is given, user 0 will be assumed.

#### Running SELECT

1. Log in to the drive to be restored (normally A:), and set the user number to 0 by typing "user 0" and pressing RETURN.
2. Place the FULLBACK or HALFBACK backup diskettes in the backup drives, in order -- diskette 001 must be in the first backup drive, 002 in the second, and so forth. (The Micro Decision has only one backup drive.)
3. Type: x:SELECT [drive codes][file name]/[user number]  
where "x" stands for the letter of the drive on which the restore program resides. The restore program need not be on the drive being backed up. If the user number is 0, the slash and the user number may be omitted.  
Under normal circumstances, the drive letter and colon are not needed.
4. The backup disks will be searched for sectors belonging to the file, in order. As each diskette is finished, a message "drive finished" will be displayed; remove the diskette and insert the next diskette in the backup set. If you do not remove a finished diskette in time, the program will prompt you to do so.
5. Continue until the message "Restore complete" occurs.

Note regarding parameter files

Be aware of this information if you are using a parameter file to exclude certain file types from a full backup. For example, you may choose to speed up the Fullback process by skipping over all .COM and .OVL files, which can be pip'ed back onto the hard disk from non-Fullback diskettes if necessary.

**If you run RESTORE from these "partial full backup" disks, all of the .COM and .OVL files presently on the hard disk will be wiped out! The parameter file technique assumes that all files excluded from the full backup are backed up somewhere else, and that you'll restore them yourself with PIP after running RESTORE.**

Remember that .COM and .OVL file types were used only as examples here. Any extension can be used in the parameter file BACK\$PRM.SYS.

Let's assume that you have been doing streamlined full backups using a parameter file, and now you find that some of your data has been trashed. Further assume that you have no backup copies of some or all of the excluded files. If you run RESTORE now, all you'll have when you're finished is the contents of the Fullback Diskettes. In our example, no .COM or .OVL files would be present on the hard disk. Egad!

The solution is to use SELECT instead of RESTORE to recover the trashed data. If the hard disk is totally inaccessible, the procedure is further complicated; we'll cover that possibility later.

Using SELECT

Those of you who have used SELECT know that it's quite slow. You have to search through all the Fullback diskettes to find the file being restored. Nonetheless, this is what you must do. Each and every file to be restored from the Fullback set must be selected individually. For example, you'll run SELECT three times to restore three files. THERE IS NO ALTERNATIVE, SINCE ONLY SELECT AND RESTORE CAN READ FULLBACK DISKETTES.

Lesson: Don't Use Parameter Files for Partial Full Backups!

If you want quick and convenient backups of a limited number of files, use PIP to copy hard disk files onto floppies. If the file is larger than 384K (that is, if it's too big for one diskette), use HALFBACK to back it up, and SELECT to copy it back.

**Messages Issued by SELECT**

Informational messages

THE BACKFIELD SELECTIVE RESTORE v [version number]. Copyright (C) 1982, Audio Light, Inc.

This message is displayed once only when SELECT is run.

Enter backup drives:

If the backup drives are not given in the command line, they are asked for here. Enter all the backup drive codes, each a letter followed by a colon.

Enter name of file to restore, "/", user number:

If the name of the file to be restored is not given on the command line, it is asked for here. Enter a file name in CP/M format, in upper or lower case, without a drive code. If the user number is other than 0 then enter, on the same line as the file name, a slash (/) followed by the user number. Example - "datafile/4" to replace file "datafile" into user area 4.

Restoring file [file name] ;[user number] onto drive [drive code] from backup with ID code [backup ID code].

Backup drives: [drive codes]

This message confirms the action SELECT is about to take.

Drive [drive code] finished.

Continuing restore from drive [drive code]

SELECT has completed reading the backup diskette in the first drive named. It will continue reading the diskette in the second drive named. No operator action is necessary.

Done restoring.

This message is displayed after SELECT has completed, just before it exits. If SELECT terminates without this message, it has not completed successfully.

Fatal error messages:

Fatal error: wrong select program. Use "SELECTL". (or: Use "SELECTS".)

The wrong select program was run. First, be sure you are logged on to the drive you wish to write the restored file to. If so, use the other SELECT program. (NOTE: Morrow ships only the SELECTL program, renamed SELECT.COM. This message should never appear.)

Fatal error: backup drive same as source drive. [drive code]

A drive specified in the command line is the same as the current logon drive. You must be logged on to the drive you wish to write the restored file to when you run the SELECT program. The backup drives must be other than the drive being restored to.

Fatal error: first backup diskette has inconsistent parameters.

The data on the backup diskette has been damaged. The diskette may have been written on by another program. Check it by displaying its directory with the CP/M DIR command; if anything other than "FULLBACK (or HALFBACK) 001 [backup ID code]" appears, the diskette has been overwritten.

Fatal error: file not found under user [user number].

The file specified in the command line or in response to the prompt "Enter name of file to restore" is not on the backup diskettes under the stated user number. The file name or the user number may have been entered incorrectly.

Fatal error: restore aborted by ctrl-C.

Following a "Wrong backup diskette" message, the operator keyed ctrl-C.

Fatal error: no room to restore file [file name].

There is insufficient space in either the directory or the data area of the drive being restored to. Erase some files from the drive and re-run SELECT. SELECT creates a temporary file while restoring the file you've selected. Thus, for example, to restore a file that is 200K in size, you need at least 400K of space available on the hard disk.

Fatal read error, drive [drive code], track [track number], sector [sector number].

An unrecoverable read error has occurred in attempting to read the backup diskette in the drive named. Either the diskette is damaged, or there is a hardware fault. SELECT cannot recover from this type of error.

Fatal write error, code [number], record [number]

An unrecoverable write error has occurred in writing to the drive being restored. The disk may have a bad sector, or there may be a hardware fault. The code number is the CP/M random write error code. The record number is the number of the random record that was being written when the error occurred. SELECT cannot recover from this error.

#### Non-fatal error messages:

Wrong backup diskette in drive [drive code] [program name] [diskette number] [backup ID code]

Install correct diskette and hit any key.

The diskette in the drive named is not the backup diskette required. It may be the wrong diskette from the backup set (the set is out of order); it may be a diskette from a different backup set; it may not be a FULLBACK or HALFBACK backup diskette.

Replace the diskette with the correct one and hit any key. The error message will be repeated until the correct diskette is in place. Alternately, you may key ctrl-C (hold down the "CTRL" key and depress the "C" key) to abort the program run.

## Backfield Utilities

The following utility programs are included with Backfield.

### BFDIR

BFDIR displays the contents of a fullback diskette set. The directory is kept on volume 001 of the set; only this disk is needed. The floppy drive letter may be placed on the command line.

### BFERASE

BFERASE is supplied to allow erasing of a diskette that was used as a FULLBACK or HALFBACK backup diskette. Since these diskettes are written in a non-CP/M format, they cannot be erased successfully with CP/M's ERA.

To use BFERASE, type:

```
BFERASE [drive code]
```

You may omit the drive code; in that case, the logon drive is assumed. Before BFERASE erases the diskette, it will prompt for confirmation that the diskette in the specified drive is to be erased.

### CHANGE

CHANGE displays the prompt:

```
Change diskettes and hit any key when ready.
```

and waits for a key to be typed; then it exits.

It is used in a SUBMIT file, to create a pause while the operator changes diskettes. See Example 4 in the "Examples" section of the appendix for the use of CHANGE.

### COMPARE

COMPARE does a binary compare of two files, and reports whether or not they are identical. To use COMPARE, type:

```
COMPARE [first file name] [second file name]
```

### CRC

CRC calculates a checksum of a file, using a CRC algorithm. It is used to determine whether or not a file has been corrupted, or whether or not two files are identical. To use CRC type:

```
CRC [file name]
```

**EXAMPLES**

**EXAMPLE 1:** Using the default parameters to back up a program development system.

The system has drive A:, an entire 11-megabyte winchester disk, and drive B:, a double-sided mini-floppy drive with 380 kilobyte capacity.

The hard disk contains many compilers, assemblers, linkers, editors, and other utilities, files of type COM and OVL; files of type BAK which are produced by the editors; SYM, PRN, LST files produced by the compilers and linkers; SUB files for use by SUBMIT; DAT files containing test data; and MAC, REL and COM files which are parts of the system under development.

About once a week the programmer backs up the entire disk with FULLBACK, so that if he has to restore he will not have to search the original diskettes for the compilers and other development programs. Since the hard disk is about half full, 13 diskettes are allowed for a FULLBACK backup. No parameter file is used. A typical backup command is:

```
FB +A B: 062384
```

where "062384" is the date. The "+A" option indicates that all files will be backed up regardless of their types. The backup takes about 20 minutes.

Each day, at the end of the day, QUARTERBACK is run. Usually, only the source files, of type MAC, need to be backed up; however, when new test data has been generated, DAT files, this data must be backed up also. A parameter file could be used to specify MAC and DAT files; however, the default types list eliminates the unwanted files from backup, so the parameter file is not used. The daily backup command is:

```
QB B:
```

The daily backup never requires more than one diskette. Often the programmer uses a partially filled diskette for the daily QUARTERBACK backup. The daily backup takes about 2 minutes.

**EXAMPLE 2:** Backing up a large data base containing many files.

The data base is stored on an 11-megabyte winchester disk. It consists of three types of files: a few large data files of type DAT which are written in random mode; many very small index files of type IDX; a number of report files of type LST, generated from the data base; a few large program files of types COM and OVL.

The data and index files are very volatile, and it is desired to back them up daily. The report files need not be backed up. Copies of the program files exist on diskettes, and it is not necessary to back them up.



## Examples

The winchester disk is drive A:, and there are two double-sided double-density 5-inch floppy drives, B: and C:, with a capacity of 380 kilobytes each.

It is decided to back up only the data and index files daily, and to keep available the previous five days' backups. Five diskettes are enough for one backup; therefore 25 diskettes, plus a few extras, are prepared.

A parameter file is created under NewWord or other text editor, with the following contents:

```
+B B: C:
DAT IDX
```

At the beginning of each working day, before any users are allowed access to the system, the backup is done with the command:

```
FB
```

and the oldest five backup diskettes are reused.

By doing the daily backup with FULLBACK, it is done very quickly, taking only about 10 minutes. A file-by-file backup procedure would take much time because of the large number of short index files. Moreover, a file-by-file backup program, unless specially written, would probably not backup the random-mode data files correctly.

### EXAMPLE 3: Archiving a large data file.

An automatic data-acquisition system has collected a very large data file -- more than three megabytes -- onto a winchester disk. It is desired to archive this file for later analysis. The winchester disk is drive A:; the floppy drive is B:. The file name is SEP81.DAT, and it is written under user 12.

This is a job for HALFBACK. The command is simply:

```
HB B:SEP81.DAT/12
```

Alternately, the operator may type

```
HB
```

and allow the program to prompt for the parameters. HALFBACK will first prompt:

```
Enter backup drives:
```

The operator responds:

```
B:
```

The program then prompts:

Enter name of file to be backed up.

The operator types:

SEP81.DAT/12

EXAMPLE 4: Backing up a set of large files with HALFBACK and a SUBMIT file

Six accounting files, named JAN81.JRN through JUN81.JRN, are to be backed up. Each is about 500 kilobytes in size, and each will fit on two diskettes. All are stored on drive A: on a winchester disk. The backup floppy drive is C:.

This job is best done using the CP/M SUBMIT facility, HALFBACK, and the utility CHANGE.

The following SUBMIT file, named "JRN.SUB", is prepared on drive A:

```

HB JAN81.JRN C:
CHANGE
HB FEB81.JRN C:
CHANGE
HB MAR81.JRN C:
CHANGE
HB APR81.JRN C:
CHANGE
HB MAY81.JRN C:
CHANGE
HB JUN81.JRN C:

```

The backup is done by logging in to drive A:, preparing 12 diskettes, and typing:

```
SUBMIT JRN
```

The program CHANGE will cause the system to pause between files, and request that the diskettes in the backup drives be changed.

EXAMPLE 5: Full restore.

This procedure assumes you do not have a proper Backfield Working Disk. Further, it is based on example 1, where many file types are excluded from the full backup. As a result, those file types will not be present on the hard disk after the restoration. Presumably they are present elsewhere or are unimportant.

## Examples

The winchester disk in the system of Example 1 has been corrupted. After reformatting the winchester, the programmer proceeds to restore the files. The last FULLBACK was done three days ago; there are nine FULLBACK diskettes and two QUARTERBACK diskettes. The restoration proceeds as follows:

The program RESTORE.COM is copied to the winchester disk (Drive A:) from a copy of the original distribution diskette.

The first FULLBACK backup diskette is put in drive B:.

This command is typed:

```
A:RESTORE B:
```

The program displays:

```
Restoring drive A: from backup with ID code "062384".
Backup drives: B:
CAUTION!!! present contents of drive A: will be destroyed.
Ready? (Y/N)
```

The programmer types:

```
Y
```

and the restoration begins. As backup diskettes are needed, prompts are displayed. The restoration continues until all 9 FULLBACK backup diskettes are read.

The programmer then inserts the earliest of the two QUARTERBACK backup diskettes in drive A:.. He then types:

```
PIP B:=A:*.*
```

He repeats this command after switching to the second QUARTERBACK diskette. When pip is finished, the winchester disk is now completely restored, up to the last run of QUARTERBACK.

### EXAMPLE 6: Selective restoration of one file.

A user of the system in Example 4 needs the file FEB81.DAT, which exists only on the diskette backup.

The operator locates the two diskettes labelled "HALFBACK backup of FEB81.DAT" and inserts the first in drive C:., and the second in drive D:.. He logs into drive A: and types:

```
SELECT
```

The program prompts:

```
Enter backup drives:
```

The operator types:

c:d:

The program prompts:

Enter name of file to restore, "/", user number:

The operator types:

feb81.dat

SELECT then searches the two backup diskettes and writes the file FEB81.DAT to drive A:, replacing a file of that name, if one exists.

### Reference Summary

**FULLBACK** - Back up all files. Backup diskettes not written in CP/M file format. May be used to backup large files and random files.

USAGE:

FB [drive codes] [options] [backup ID]

**QUARTERBACK** - Back up only files that have changed since last backup. Backup disk written in CP/M file format. Cannot be used to backup a large file.

USAGE:

QB [drive codes] [options]

**HALFBACK** - Back up one large file to multiple diskettes. Backup diskettes are not written in CP/M file format.

USAGE:

HB [drive codes] [filename]

**RESTORE** - Read diskettes written by FULLBACK. The contents of the drive are replaced by the backup files.

USAGE:

RESTORE [drive codes]

**SELECT** - Read diskettes written by HALFBACK and FULLBACK. Restores a single file to the desired disk. Does not affect the other files on the target disk.

USAGE:

SELECT [drive codes] [filename] ;[user no.]

## Summary

PARAMETER FILE - Used to indicate backup drives, program options and file types to be backed up.

### FORMAT:

[drive codes] [options] - line 1 of file  
[list of file types] - line 2 of file

### OPTIONS -

Used by FULLBACK and QUARTERBACK:  
\$ - compute checksum file only (FULLBACK only)  
\$ - list files that have changed (QUARTERBACK only)  
+A - backup all file types except .\$\$\$  
+B - backup only file types in types list  
+O - backup all files except those in types list

## APPENDIX B

### PROGRAMMING MDT-60 / MT-70 FUNCTION KEYS (KEY.COM)

#### CONTENTS

|                                                     |      |
|-----------------------------------------------------|------|
| Preliminary Notes . . . . .                         | B-1  |
| General Information . . . . .                       | B-1  |
| What KEY.COM Does . . . . .                         | B-2  |
| Key Definition Files (XXX.KEY) . . . . .            | B-2  |
| Using KEY.COM and .KEY Files . . . . .              | B-3  |
| What the Keys Do, as Programmed By Morrow . . . . . | B-4  |
| Under CP/M (The Default Values) . . . . .           | B-4  |
| NewWord . . . . .                                   | B-5  |
| SuperCalc . . . . .                                 | B-7  |
| Quest . . . . .                                     | B-8  |
| Customizing the Key Definition Files . . . . .      | B-9  |
| Changing an Existing File . . . . .                 | B-10 |
| Creating a New File . . . . .                       | B-11 |
| Technical Details . . . . .                         | B-12 |
| Definition Files, Keynames . . . . .                | B-12 |
| Definition Lines, Special Characters . . . . .      | B-13 |
| Comments and Special Definitions . . . . .          | B-13 |
| Chaining to Other Programs . . . . .                | B-14 |
| Start Option, Terminal Initialization . . . . .     | B-15 |
| Numeric Keypad as Function Keys . . . . .           | B-16 |
| Fast vs. Slow Mode . . . . .                        | B-17 |

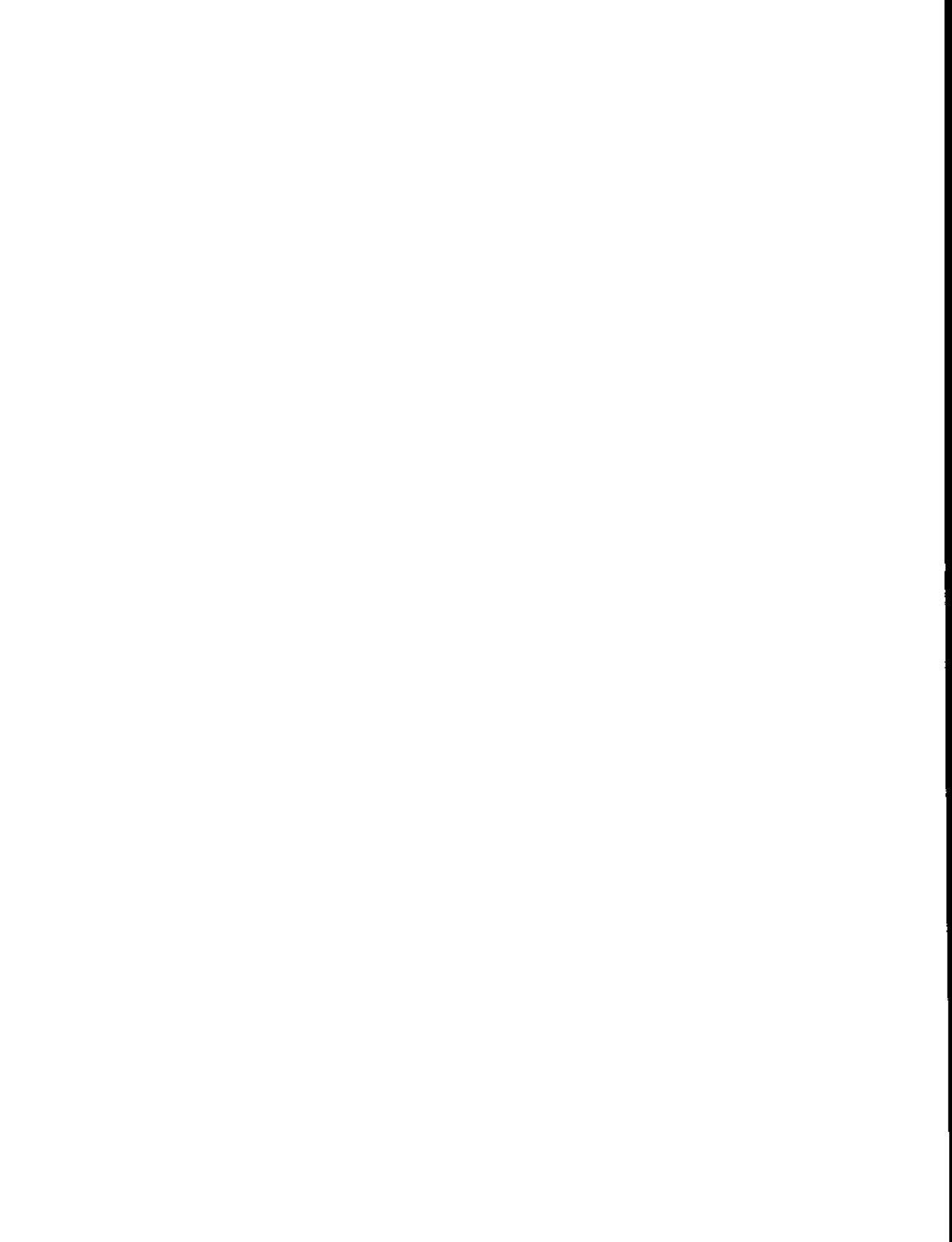

## APPENDIX B

---

### PROGRAMMING MDT-60 / MT-70 FUNCTION KEYS (KEY.COM)

#### Preliminary Notes

1. This section assumes you're using a Morrow MDT-60 or MT-70 terminal with the Micro Decision. Other terminals are so unpredictable where function keys are concerned that you'll need more general-purpose function key software to program them. Such software is widely available but is not supplied by Morrow.
2. Switch 8 in the bank of either terminal's setup switches must be turned OFF. This is the normal setup.
3. All references below to the MT-70 apply as well to the MDT-60, except as noted.

#### General Information

Function keys are those labelled F1 through FD, along with the arrow keys and a few others (HELP, HOME, ERASE, and SETUP) \*. They are there for users to program to stand for a command, sequence of commands, or frequently-typed piece of text.

The terminal always sends out the same code when you press a function key. The translation of the code into a command or text takes place through special software that sits between CP/M and your business program. KEY.COM is one example of this intermediate software. It was designed solely for Morrow computers and terminals.

- \* The MDT-60 has no F10 key, but an equivalent ERASE key instead. The FA-FD keys are used only on the MT-70. There is no SETUP key on the MT-70.



## **What KEY.COM Does**

KEY.COM is a program that, by itself, does almost nothing. It is always used in conjunction with other special files that end in ".KEY".

Each business program (NewWord, SuperCalc, etc.) will have a .KEY file associated with it that contains the meanings for all keys you want to use. NewWord's key file is named "NW.KEY", for example. These are referred to in general as "key definition files".

KEY.COM loads the key definitions into memory and handles the translations of the actual keycodes into commands or text.

## **Key Definition Files (XXXX.KEY)**

For any program that you want to use with function keys, you will create a file unique to that program, with a name ending in .KEY. You can use NewWord or another text editor to create and change the file.

Morrow has taken the liberty of creating NewWord's and SuperCalc's key definition files for you (NW.KEY and SC.KEY, which are present in user 0 of your hard disk). If you don't like the definitions that Morrow has selected, use NewWord to change them. This is covered on page B-9.

The key definition files have a very particular format that establishes what the function key will mean when pressed by itself, when pressed with the SHIFT key, and when pressed with the CTRL key. In other words, each key can have three meanings.

You don't have to define three meanings for each key, and you don't even have to define every key. You can also just leave the definition files alone and use the keys as programmed by Morrow.

## Using KEY.COM and .KEY Files

Your Co-Pilot menus are able to tell whether you're using an MDT-60/MT-70, and decide whether to use key files accordingly.

To run a program outside of the Co-Pilot menu system, you'd normally type a command like "nw" for NewWord. Now, to include the function keys for NewWord, the command becomes:

**key nw**

### What happens when you enter "key nw"?

First, CP/M reads KEY.COM from the current disk drive (where it must be present), then it reads NW.KEY from the same disk. Presumably you want it to proceed with running NewWord. For KEY.COM to continue with NewWord, NW.KEY must contain a special "chaining line" which will be described later. This line is included in the version of NW.KEY as shipped from Morrow.

Without the chaining line, the key definitions are loaded into memory and the A> prompt returns. No program would be run automatically, but you'll notice that your function keys now stand for the NewWord commands.

The meanings for keys stay in memory until you reset the Micro Decision (or turn it off), or until you use another "key" command to load a different set of definitions.

## What The Keys Do, As Programmed By Morrow

### **Under CP/M (The Default Values)**

These meanings are contained in DEFAULT.KEY. They are automatically loaded when you boot CP/M, and stay in effect until you enter another KEY command.

As shipped, the only function keys that have useful meanings when you're not running a program are HELP, HOME, and the arrow keys.

- o The HELP key sends out the text string "help". This has the effect of running CP/M 3.0's online help program. See the CP/M Plus User's Guide for more on the HELP command.
- o The HOME key sends out ^X, which tells CP/M to cancel any part of a command typed so far, and redisplay the system prompt.
- o The arrow keys have line-editing meanings, for correcting CP/M command lines that you're typing:

LEFT ARROW - Unshifted or with CTRL is same as DELETE or ^H. Moves cursor to left, deleting characters as it goes. Shifted, same as ^A: move cursor left without deleting.

UP ARROW - Unshifted is same as ^B: move cursor from one end of the command line to the other. Shifted or with CTRL: repeat last command (^W).

DOWN ARROW - No effect unshifted, shifted, or with CTRL.

RIGHT ARROW - Unshifted same as Space Bar, i.e., insert space. Shifted same as ^F: move cursor one character to right. With CTRL, same as ^G: delete character under cursor without moving the cursor.

**NOTE:** DEFAULT.KEY is a special case. These meanings are built into the hard disk version of CP/M. Therefore they get into memory without you having to enter "key default".

You would enter "key default" only to return the keys to their default definitions after running another program with a different key file. You can get the same effect by resetting the Micro Decision.

You can change these defaults and also give meanings to the other function keys by editing the file named DEFAULT.KEY. See "Customizing the Key Definition Files" on page B-9.

Since most key files have a "chaining line" that says which program to run after the key definitions are loaded, this file would not have such a line. The chaining of key definitions to their programs is covered later.

### **NewWord**

The table below lists the default values for the function keys when running NewWord. The CTRL (^) codes in parentheses are the equivalent NewWord commands. The Auxiliary keys are pressed before the function key and held down while the function key is pressed.

| <u>Key</u>  | <u>Auxiliary Key</u> | <u>Meaning</u>                                |
|-------------|----------------------|-----------------------------------------------|
| UP ARROW    |                      | Move cursor up one line (^E)                  |
| UP ARROW    | SHIFT                | Scroll text up one line (^Z)                  |
| UP ARROW    | CTRL                 | Scroll text up a screenful (^R)               |
| DOWN ARROW  |                      | Move cursor down one line (^X)                |
| DOWN ARROW  | SHIFT                | Scroll text down one line (^W)                |
| DOWN ARROW  | CTRL                 | Scroll text down a screenful (^C)             |
| LEFT ARROW  |                      | Move cursor one space left (^S)               |
| LEFT ARROW  | SHIFT                | Move cursor one word left (^A)                |
| LEFT ARROW  | CTRL                 | Cursor to left end of line (^QS)              |
| RIGHT ARROW |                      | Move cursor one space right (^D)              |
| RIGHT ARROW | SHIFT                | Move cursor one word right (^F)               |
| RIGHT ARROW | CTRL                 | Cursor to right end of line (^QD)             |
| F1          |                      | Undo or unerase (^U); same with SHIFT or CTRL |
| F2          |                      | Save and resume edit (^KS)                    |
| F2          | SHIFT                | Save and end edit (^KD)                       |
| F2          | CTRL                 | Save and exit from NewWord (^KX)              |
| F3          |                      | Align a paragraph (^B)                        |
| F3          | SHIFT                | Align entire document (^QR + ^QB)             |
| F3          | CTRL                 | Toggle right justify on/off (^OJ)             |
| F4          |                      | Mark block beginning (^KB)                    |
| F4          | SHIFT                | Move block (^KV)                              |
| F4          | CTRL                 | Write block on disk (^KW)                     |

### NewWord Keys, continued

|           |       |                                     |
|-----------|-------|-------------------------------------|
| F5        |       | Mark block end (^KK)                |
| F5        | SHIFT | Copy block (^KC)                    |
| F5        | CTRL  | Insert block from disk (^KR)        |
| F6        |       | Paragraph indent (^OG)              |
| F6        | SHIFT | Set left margin (^OL)               |
| F6        | CTRL  | Set right margin (^OR)              |
| F7        |       | Find a character or string (^QF)    |
| F7        | SHIFT | Find and replace (^QA)              |
| F7        | CTRL  | Find/replace again (^L)             |
| F8        |       | Delete character to left (DEL)      |
| F8        | SHIFT | Delete word under cursor (^A + ^T)  |
| F8        | CTRL  | Delete line left of cursor (^Q DEL) |
| F9        |       | Delete character under cursor (^G)  |
| F9        | SHIFT | Delete word from cursor (^T)        |
| F9        | CTRL  | Delete line right of cursor (^QV)   |
| F10/ERASE |       | Delete entire line (^Y)             |
| F10/ERASE | SHIFT | Delete block (^KY)                  |
| F10/ERASE | CTRL  | Delete a file while editing (^KJ)   |
| TAB       | SHIFT | Set tab stop (^OI)                  |
| TAB       | CTRL  | Clear tab stop (^ON)                |
| HELP      |       | Start help messages (^J)            |
| HELP      | SHIFT | Set help level to 3 (^JJ3)          |
| HELP      | CTRL  | Set help level to 1 (^JJ1)          |
| HOME      |       | Move to beginning of file (^QR)     |
| HOME      | SHIFT | Move to end of file (^QC)           |
| HOME      | CTRL  | Hide block markers (^KH)            |

Refer to "Customizing the Key Definition Files" (p. B-9) for instructions on changing these keys.

## SuperCalc

This list shows the default meanings of the keys as defined by Morrow for SuperCalc in "sc.key". Where SHIFT or CTRL is not listed for a function key, you can assume that the key acts the same whether you use it alone or with the SHIFT/CTRL keys.

| <u>Key</u>  | <u>Auxiliary Key</u> | <u>Meaning</u>                             |
|-------------|----------------------|--------------------------------------------|
| UP ARROW    |                      | Move active cell up one row (^E)           |
| DOWN ARROW  |                      | Move active cell down one row (^X)         |
| LEFT ARROW  |                      | Move active cell one column left (^S)      |
| RIGHT ARROW |                      | Move active cell one column right (^D)     |
| F1          |                      | Load existing spreadsheet from disk (/L)   |
| F2          |                      | Save spreadsheet on disk (/S)              |
| F3          |                      | Quit, with option to back out (/Q)         |
| F3          | SHIFT                | Same as unshifted F3 (/Q)                  |
| F3          | CTRL                 | Quit without option (/Q Y)                 |
| F4          |                      | Move row or column range of cells (/M)     |
| F4          | SHIFT                | Copy row or column range of cells (/C)     |
| F4          | CTRL                 | Replicate row or column range (/R)         |
| F5          |                      | Edit contents of cell (/E)                 |
| F5          | SHIFT                | Insert empty row or column (/I)            |
| F5          | CTRL                 | Not used                                   |
| F6          |                      | Specify display format (/F)                |
| F6          | SHIFT                | Set global options (/G)                    |
| F6          | CTRL                 | Not used                                   |
| F7          |                      | Lock column and/or row on display (/T)     |
| F7          | SHIFT                | Split display window (/W)                  |
| F7          | CTRL                 | Not used                                   |
| F8          |                      | Output spreadsheet in display format (/OD) |
| F8          | SHIFT                | Output spreadsheet contents only (/OC)     |
| F8          | CTRL                 | Not used                                   |
| F9          |                      | Protect cell contents/display format (/P)  |
| F9          | SHIFT                | Unprotect (/U)                             |
| F9          | CTRL                 | Not used                                   |
| F10/ERASE   |                      | Cancel operation or entry (^Z)             |
| F10/ERASE   | SHIFT                | Erase row, column, or file (/D)            |
| F10/ERASE   | CTRL                 | Clear range contents & reset format (/B)   |
| HELP        |                      | Start help messages (?)                    |
| HOME        |                      | Go to upper left corner of sheet (=A1)     |
| HOME        | SHIFT                | Same as unshifted HOME (=A1)               |
| HOME        | CTRL                 | Zap spreadsheet with backout option (/Z)   |

Refer to "Customizing the Key Definition Files" (p.B-9) for instructions on changing these keys.

## Quest

Quest has built-in meanings that it assigns to the function keys. The meanings can vary according to where you are in the program. Quest expects the keys to have their default "CP/M" values (the ones present after booting, but before another set of definitions is loaded with a key command).

Therefore if NewWord's key meanings are still in memory when you begin Quest, strange things will happen.

There is a special file called "default.key" whose sole purpose is to reload the default values for the keys. Enter the command **key default** to clear out other key definitions from memory. (The Co-Pilot menus do this automatically.)

## Personal Pearl, Correct-It, and BASIC

The usefulness of function keys within these programs is dubious. Morrow has not established any special values for them, so the function keys will operate unpredictably. If you want to set up key definitions for these programs, create a file called, for example, BASIC.KEY according to the instructions that follow. Then when you go to run BASIC (from CP/M), instead of typing "basic", type "key basic".

## Customizing the Key Definition Files

There are a few rules that you have to abide by when creating or changing key definition files like nw.key and sc.key. The best way to understand this is to look at an example. Here is a partial printout of nw.key, with rules added:

```
;FUNCTION KEY DEFINITIONS FOR NEWWORD WITH MDT-60/MT-70
;
*NW.COM NW.COM is the file to "chain to".
UP ^E
^UP ^Z Comments can be added anywhere in the
^UP ^R file; they must have a semicolon as
DOWN ^X the first character.
^DOWN ^W
^DOWN ^C The arrow keys are represented by the
LEFT ^S words UP, DOWN, RIGHT, and LEFT.
^LEFT ^A
^LEFT ^QS The SHIFT key is represented by a
RIGHT ^D tilde (~). The CTRL key appears as
^RIGHT ^F a caret (^). Thus "^RIGHT" means the
^RIGHT ^QD function that occurs when you hold
F1 ^U down the SHIFT key and press the right
^F1 ^U arrow key.
^F1 ^U
F2 ^KS The regular function keys are listed as
^F2 ^KD F1 through FD (F9 on MDT-60). F10 on
^F2 ^KX the MT-70 is the same as ERASE on the
^TAB ^OI MDT-60. The file can contain either name.
^TAB ^ON

 Blank lines don't matter.

HELP ^J
^HELP ^JJ3_RTN Other valid function key names are
HOME ^QR TAB, HELP, HOME, and SETUP.
```

Now for rules regarding what you can make the key do:

- o A function key can be programmed to mean any command, sequence of commands, or piece of text. For example, you can program a key to stand for a four-line letterhead.
- o The string represented by any key must be less than 128 characters.



- o The entire key file must be less than (around) 1K byte. Unfortunately, the Micro Decision measures files in 4K increments so the only simple way to tell that a file's too big is if you get an error message telling you so when you try to use it.
- o There are many details and options that we'll describe after a general discussion of modifying a .KEY file.

### Changing an existing file:

We'll use `nw.key` as our example; the other existing key files are `sc.key` for SuperCalc and `default.key` for CP/M and Quest.

1. Escape from the Co-Pilot Menus by pressing the ESC key at the Main Menu.
2. When you see "A>", type `nw` and press RETURN. This starts NewWord. At NewWord's Opening Menu, type `N` to open a non-document file. Give `nw.key` as the name of the file to edit.
3. Remembering the rules mentioned above, make changes as you please. Here's an example:

Suppose you want to make the shifted F6 key stand for your company's name and address. Now every time you type a letter, you just hit SHIFT and F6 and the information appears.

- o Locate the line beginning with `~F6`. Put your cursor on its current definition (`^OL`). Erase this with `^T`. Now type the new definition, something like:

```
~F6 Lister Auto Sales _RTN1203 Buncombe Street _RTNGreer, S.C. 29611 _RTN
```

- o Don't hit RETURN to represent a return; type `_RTN`. Hit RETURN only after you finish typing the whole definition. We'll get to the details of "special definitions" like `_RTN` in a moment.

Another example: Say you want to add a line for an unshifted FA key (MT-70 only) that simulates a `^N` under WordStar, that is, it inserts a blank line above the line where your cursor is positioned.

- o Go to the end of nw.key with ^QC.
  - o Add the key symbol first. Type FA.
  - o Then type the meaning for FA. Press TAB. Now type ^E^QD RTN. Don't use the CTRL key to get the caret onscreen; simply type the caret (shifted 6).
  - o Hit RETURN after typing the meaning of the command. Save nw.key with ^KX.
4. When you see "A>" again, type set nw.key [sys] and press RETURN. Always enter this command after editing nw.key or any other key file (of course, the file name will differ).
  5. Type pilot go to get back into the menus, if desired.

#### Creating a new file:

Let's say you just bought a program called REALITY with a main command file named reality.com. You've loaded it onto the hard disk in user 0. Now you want to establish a key file for it.

1. Escape from the Co-Pilot Menus by pressing the ESC key at the Main Menu. When you see "A>", type nw and press RETURN to start NewWord.
2. At NewWord's Opening Menu, type N to open a non-document file. Give reality.key as the name of the file to edit. Answer Y to create a new one.
3. Start typing key names and their meanings according to the rules in the previous sections, and the rules in "Special Characters" and "Comments and Special Definitions" below.
4. Somewhere in the file you should include the name of the file to chain to. If you don't name a file to chain to, the key definitions are loaded into memory and the CP/M prompt (A>) returns. If you do give a chained file name in reality.key, that file will be executed automatically after the key definitions are put in memory. See "Chaining to Other Programs" below.

5. Be sure you press RETURN after typing the last line of the file. Then save the file with ^KX.
6. When you see "A>" again, type **set reality.key [sys]** and press RETURN. You should use this command (with the appropriate file name) whenever you edit a key definition file.
7. To run REALITY now with function keys, type **key reality** and press RETURN. Or type **pilot go** and RETURN to get back into the menus.

### And Now For All The Details...

#### **.KEY Files**

Any .KEY file can have from 0 to an undetermined number of definition lines. A zero-line file has the same effect as entering "key" with no .KEY file name (below). Additional lines may be included: comments and special definitions. See below.

The maximum file size for any .KEY file on a hard disk Micro Decision is 1,000 bytes.

#### **Key Names in .KEY Files**

The available key names are shown below. They must be spelt as shown; however, you can use upper or lower case letters.

|    |    |    |     |      |       |      |       |
|----|----|----|-----|------|-------|------|-------|
| F1 | F4 | F7 | F10 | FC   | HOME  | TAB  | LEFT  |
| F2 | F5 | F8 | FA  | FD   | ERASE | UP   | RIGHT |
| F3 | F6 | F9 | FB  | HELP | SETUP | DOWN |       |

ERASE and SETUP are unique to the MDT-60. FA-FD are unique to the MT-70.

The shifted version of a key is typed as ^KEYNAME. CTRL versions are typed as ^KEYNAME.

## Definition Lines

A definition line in a .KEY file consists of the key's name separated from its definition by one or more spaces or tabs. The definition must be all on one line, with 240 or fewer characters. Definitions consist of normal characters with a few reserved special characters.

## Special Characters

Within a key's definition, there are four characters that have special meaning to KEY.COM:

- The underscore signals the beginning of a special definition, like `_RTN`. See below.
- ^ The caret within definitions (just as in key names) to signify a CTRL-key command, like `^G` to erase a character with NewWord. Just about all of the definitions in `NW.KEY` are of this type. Use the caret key (shifted 6) for typing the symbol.
- ; The semicolon signals the beginning of a comment. Usually comments go on lines by themselves; you can end a definition and begin a comment on the same line by using a semicolon.
- \ The backslash says "Take the next character literally." Suppose you wanted a key definition containing a caret, underscore, or semicolon, like "`^PS means _underscore_;`". To program a key to print that exact string, the definition would be: `\^PS means \_underscore_\;` The backslash prevents KEY.COM from treating these characters as anything special.

## Comments and Special Definitions

Comments can be included anywhere in a .KEY file. Any text between a semicolon (;) and the end of a line is regarded as a comment. You can have a line that is nothing but a comment by beginning the line with a semicolon. You can include comments in key definition lines by using a semicolon after the definition and before the comment.

"Special definitions" is something of a catch-all for various details that don't fit in elsewhere. They are listed below.

**\_RTN** This string represents a carriage return within a definition. Since the whole definition must be on one line, a 3-line address would look something like

```
Name_RTNAddress_RTNCity/State
```

If you use this definition in a file, the cursor will be at the end of the State after you press the key. You could put another **\_RTN** after City/State, in which case your cursor would end up on the line below the city and state. You could actually put several **\_RTN**'s after the address to create a number of blank lines automatically.

**\_DEL, \_TAB, and \_ESC** These three strings stand for the ASCII DEL, TAB, and ESC characters (7F, 09, and 1B Hex respectively). NW.KEY uses **\_DEL** as part of one definition (**^Q\_DEL**). Whenever you want a definition to include a tab keystroke, use **\_TAB**. Use **\_ESC** to send your terminal an initialization string. See "Terminal Initialization" below.

### Chaining to Other Programs

"Chaining" means that KEY.COM automatically runs some other program after it loads your key definitions into memory. The requirements are very simple: Somewhere in the .KEY file is a line consisting of the word CHAIN and the main .COM file name for the program you want to chain to. (Your Morrow-supplied .KEY files use an asterisk (\*) instead of the word CHAIN on chaining lines. Either method works, but CHAIN is preferred for consistency's sake.)

In NW.KEY, the line is **CHAIN NW.COM** or\* **NW.COM**. In SC.KEY, it's **CHAIN SC.COM**. "CHAIN" and the .COM file name must be separated by at least one space or tab. DEFAULT.KEY has no such line because it isn't supposed to chain to anything.

If your program allows "arguments" on the command line (like text file names with NewWord), they can be included in the chaining line as well. This is not nearly as useful, however, as the "Start" line below.

A final note on chaining from the key file to a command file. There might be times when you don't want to chain. For example, you may have a single key file for a set of several related programs. In this case, you'd leave out the chain line (the one starting with CHAIN or \*) from the key file.

Let's say your key file is named "account.key", and it defines keys for the various modules making up an accounting package. To use the keys, type "key account." This loads the key definitions into memory and returns you to the A> prompt without chaining to any particular program. Now type the program name, such as "ledger". When you exit from ledger, the keys are still in memory. So you could then move along to "payables" without re-loading account.key.

### The START Option

You can fool a chained program into thinking that you're issuing it certain preliminary commands by using a "Start" line in the .KEY file. The contents of the line are fed to the program just as if you were typing the commands on your keyboard.

For example, you could start NewWord, set the Help level, and open a document automatically with the lines:

```
CHAIN NW.COM
START ^J^J2_RTND
```

This sets the help level to 2 (^J^J, 2, and RETURN), then "types" a D to open a document. Your first keystrokes would be the name of the document.

The START line can also be anywhere in the file; it need not be adjacent to the chaining line.

### Terminal Initialization (The TERM Line)

Another feature of KEY.COM is its optional ability to send your terminal control codes and escape sequences. This is done with another special line that begins with the word "TERM". Typical uses for this would be to select a different cursor type, turn keyclick on or off, and to enable the function key mode of the numeric keypad (see "For Function Key Hogs Only" below).

To take advantage of the TERM line, you must be advanced enough to understand control codes and escape sequences. They are listed in the terminal's user guide.

For example, this line does all of the things mentioned above:

```
TERM _ESC"3_ESCJO_ESC[
```

\_ESC"3 turns the cursor into a slow-blinking underline. \_ESCJO turns the keyclick off. \_ESC[ turns the numeric keypad into an additional set of 14 function keys.

#### For Function Key Hogs Only

Something we've conveniently failed to mention until now is that the MDT-60 and MT-70 can be set to use the numeric keypad (the one that looks like an adding machine) as an additional block of function keys.

If you assign 3 meanings to each of the regular function keys, you have a total of 63 definitions. With full use of the numeric keypad, the total is raised to 105.

To convert the numeric keypad to function key mode, you must use a TERM line (above) that contains at least "\_ESC(", or otherwise send this escape sequence to the terminal.

The key names you can use in a .KEY file for the numeric pad are:

|   |   |   |   |       |
|---|---|---|---|-------|
| 1 | 4 | 7 | 0 | ,     |
| 2 | 5 | 8 | . | ENTER |
| 3 | 6 | 9 | - |       |

These can also be used with SHIFT or CTRL, as in ^ENTER or ^0.

## "Fast" versus "Slow" Mode

The only details remaining are the special lines "SWITCH\_FST" and "SWITCH\_SLW". (The Morrow key files may include "#\_FST" -- the pound sign is equivalent to the word SWITCH.)

NOTE: Investigate this section only if you're having curious problems with .KEY files you've created. See the list of four circumstances below. Otherwise you can ignore these details.

Fast and Slow modes are confusion factors rather than convenience features. They were needed because CP/M has two ways of checking whether a character has been typed: WITH a check for "console status", and WITHOUT the status check.

There are four basic combinations of circumstances:

1. The program checks console status, and the .KEY file is in slow mode. This can have two results. Either only one character of your definition appears when you press the function key, with the rest of the characters appearing one at a time as you press further keys (any keys will do); or, your definition will tick onto the screen at a very slow pace. The latter occurs when the program uses a timeout loop. In general, these situations are ripe for switching to Fast mode.
2. The program checks console status, and the .KEY file is in fast mode. Usually this works just fine. The definition appears almost instantaneously when you press the function key. HOWEVER. . . There are occasional situations where characters are lost into thin air. Specifically, if the program is doing something and the only thing it cares about from the terminal are control codes like ^S (to tell it to pause), it throws away anything other than these control codes.

For example, if you have a key that is a combination of CP/M commands (like "pip B:=\*.\*\_RTNshow B:\_RTN"), the pip command will work but all or part of the show command gets gobbled up by CP/M. Solution: Use slow mode here.



3/4. The program doesn't check console status. With these programs, it doesn't matter whether you're in Slow or Fast mode. The characters will appear instantaneously when you press the function key. None of the anomalies noted above occurs.

#### Using Fast and Slow Modes

Now that you have enough information to decide which mode is more appropriate for your program, here's how to implement it. Be aware that if slow mode is right for the program, you don't need a command for it in the .KEY file. Slow mode is used by default.

If the whole .KEY file is to be in fast mode, include this line at some place in the file, starting in column one and on a line by itself:

```
SWITCH _FST For a fast .KEY file
```

In rare cases, you may want to switch back and forth between fast and slow modes within a given .KEY file. You may, for example, have one file that uses half of the keys for NewWord and half for CP/M commands. In this case, put the file into Fast mode with the SWITCH \_FST line. On the CP/M command definitions, switch to slow mode and back again thus:

```
_SLWpip B:=*.*_RTNshow B:_RTN_FST
```

Notice the word SWITCH is not used when the fast/slow flags are used within a key definition.

#### A couple of quick technical notes:

KEY.COM automatically returns the system to slow mode after a warm boot.

The \_RTN flag generates only a carriage return (^M), without a line feed (^J). In some programs you may find that a multi-line definition keeps writing over itself on the same line. Or a script of prompt responses doesn't work because the program expects two characters as a line ending. In these cases, use \_RTN^J instead of simply \_RTN.

### Entering "key" with no .KEY file name

With the current release of KEY.COM, this reports the KEY.COM version number and clears out all definitions that may be in memory. This includes the default (CP/M line editing) definitions that are built into the BIOS. Those definitions are automatically in memory any time you boot the Micro Decision, or any time you enter "key default".

### Last Comment

This was mentioned already, but you may have skimmed over it: The definitions for keys, once loaded into memory, stay in memory until you load in a different key file or do a cold boot (turn the system off or press RESET). A warm boot (^C) does not clear the keys or return them to their CP/M line editing values.

To return the keys to their default values without resetting, type **key default** at the "A>" prompt.



**APPENDIX C**

-----  
**RUNNING CP/M 2.2 SOFTWARE ON THE HARD DISK SYSTEMS**

**CONTENTS**

Introducing CPM2.COM, CPM3.COM, and CPM2.RSX . C-1  
Using CPM2.COM and CPM3.COM. . . . . C-1  
Using CPM2.RSX . . . . . C-2  
When a Program Won't Work With CPM2.RSX. . . . C-3



## APPENDIX C

---

### RUNNING CP/M 2.2 SOFTWARE ON THE HARD DISK SYSTEMS

As mentioned on page 3-8, there are some CP/M 2.2 programs that don't work well with CP/M version 3.0. This is a small minority of the available software. Morrow has provided three special files that, as far as we know, fix any such problems. This appendix contains the details for using these files.

#### Introducing CPM2.COM, CPM3.COM, and CPM2.RSX

- o **CPM2.COM** simulates a CP/M 2.2 environment on the hard-disk systems.
- o **CPM3.COM** returns the system to normal 3.0 operation.
- o **CPM2.RSX** is a special file that can be attached to frequently-used 2.2 programs, eliminating the need to enter either of the two commands above.

#### Using CPM2.COM and CPM3.COM

These two programs are intended to be used when you want to test a business program in the simulated CP/M 2.2 environment, or if you use the business program only once in a while. After you've verified that the program responds well to CPM2.COM, you can use CPM2.RSX to make the process automatic.

To muddy the waters, be aware that some CP/M 2.2 programs work when you run the CPM2.COM program, but not when you merge them with CPM2.RSX. More on this below.

This procedure assumes that you've already copied (PIP'ed) the business program onto your hard disk. If you intend to run it from a floppy disk instead, add **B:** to the startup command for the program in step 3 below.

1. Escape from the Co-Pilot menus with the ESC key if you haven't done so already.
2. At the "A>" prompt, type **CPM2** and press the RETURN key. Your system is now ready to run business programs written for CP/M 2.2.

3. As an example, to run DataStar now, type **DATASTAR** and hit RETURN.
4. After exiting from DataStar (or other 2.2 program), at the "A>" prompt, type **CPM3** and RETURN.

```

***** NOTE! NOTE! NOTE! NOTE! NOTE! *****
*
* The ONLY thing you should do while in CPM2 mode is *
* to run business programs like DataStar. You should *
* NOT try to run CP/M utilities like DIR, PIP, and *
* FORMAT. Nor should you run your normal CP/M 3.0 *
* software (NewWord, SuperCalc, Backfield, etc.) *
*
* After running a CP/M 2.2 business program, return to *
* CPM3 mode with the CPM3 command (step 4 above). You *
* get the same result by hitting the RESET button, or *
* by using CPM2.RSX instead of CPM2.COM and CPM3.COM. *
*

```

### Using CPM2.RSX

This is usually preferable to using CPM2.COM and CPM3.COM. The file CPM2.RSX is attached to your business program's .COM file, with the result that CP/M 2.2 simulation occurs automatically when you run the business program. The system is automatically returned to CP/M 3.0 mode when you exit from the business program.

As mentioned above, there are a few situations where you've bought a program; it won't work with CP/M 3.0; you run CPM2.COM and then run the program and everything works great; now you try to merge it with CPM2.RSX and you get a whole new set of problems. When that happens, you're stuck with having to run CPM2.COM, then the program, and then CPM3.COM. Sorry. In a moment we'll give you a shortcut for dealing with these exceptions.

This procedure assumes that your business program has already been copied (PIP'ed) onto your hard disk. If you intend to run it from a floppy instead, add B: to the filename in step 2 below.

We'll be using DataStar as an example. Its main file is called DATASTAR.COM. Your file name will vary, but it's always the startup command for the program, with ".COM" added.

1. Escape from the Co-Pilot Menus with the ESC key if you haven't done so already.
2. At the "A>" prompt, type **GENCOM DATASTAR CPM2** and hit RETURN. The GENCOM program (which came with your Micro Decision) knows that you want to attach CPM2.RSX to DATASTAR.COM.

That's it! From now on, when you run DataStar, it's as if you had entered the CPM2 command, and entered the CPM3 command afterward, but it's all automatic. Therefore you can disregard the warnings in the box on the previous page when you use the GENCOM command as described above.

One last thing to be aware of (in very rare cases): After running GENCOM on the program, it won't work on a regular CP/M 2.2 system anymore; that is, you could not take a copy of DataStar after the GENCOM and run it on a floppy-disk Micro Decision. You'd have to un-GENCOM it first with the command **GENCOM DATASTAR**.

#### When a Program Won't Work With CPM2.RSX...

The first thing you must do is get rid of the RSX attachment by un-GENCOM'ing the program. For DataStar, you'd enter **GENCOM DATASTAR**. Now DataStar is back like it was before the first GENCOM command.

Now you can create a SUBMIT file to handle the three commands for you. We'll still use DataStar as our example, so remember that your command in the middle of step 2 will be different.

1. At the A> prompt, type **NW** and hit RETURN to start NewWord. Open a new NON-DOCUMENT (type **N**); name the file something like "DS.SUB". The only important part is the .SUB ending, and the first name should be different from the .COM file's first name (that is, we don't want to use "DATASTAR.SUB").



2. Put these three lines into DS.SUB:

```
CPM2
DATASTAR
CPM3
```

3. Save the file and exit with **^KX**.

To run DataStar now, simply type **DS** and hit RETURN. First CPM2.COM is loaded; then DATASTAR.COM runs. When you exit from DataStar, CPM3.COM returns the system to its normal CP/M 3.0 state. The only thing that can go wrong in this method is if you've changed the "setdef" line in the file PROFILE.SUB. If the computer goes "DS?" when you try to run DataStar as described above, just try again with the command **SUBMIT DS**.

### Post Script

If you encounter any business programs that are supposed to work under CP/M 2.2, and you still have problems even after following all of the preceding instructions, please send the name of the program, the nature of your problem and what makes it occur, and if at all possible a copy of the program, to:

Morrow, Inc.  
Dealer Support Department  
600 McCormick  
San Leandro, CA 94577

APPENDIX D

-----  
CONNECTING DEVICES TO THE MICRO DECISION

CONTENTS

|                                                   |      |
|---------------------------------------------------|------|
| Types of Transmission . . . . .                   | D-2  |
| The Serial (RS-232) Connectors . . . . .          | D-3  |
| The Centronics Connector . . . . .                | D-4  |
| The Auxiliary Connector. . . . .                  | D-4  |
| The RS-422 Connector . . . . .                    | D-5  |
| Crash Course in Baud Rates and Protocol . . . . . | D-5  |
| The SETUP Program . . . . .                       | D-6  |
| Using Two Printers. . . . .                       | D-9  |
| Regarding NewWord and Two Printers . . . . .      | D-10 |
| Modems. . . . .                                   | D-10 |
| CP/M Device Definitions . . . . .                 | D-12 |
| I/O Ports . . . . .                               | D-12 |
| RS-422 Pin Connections. . . . .                   | D-13 |
| The Expansion Connector . . . . .                 | D-13 |

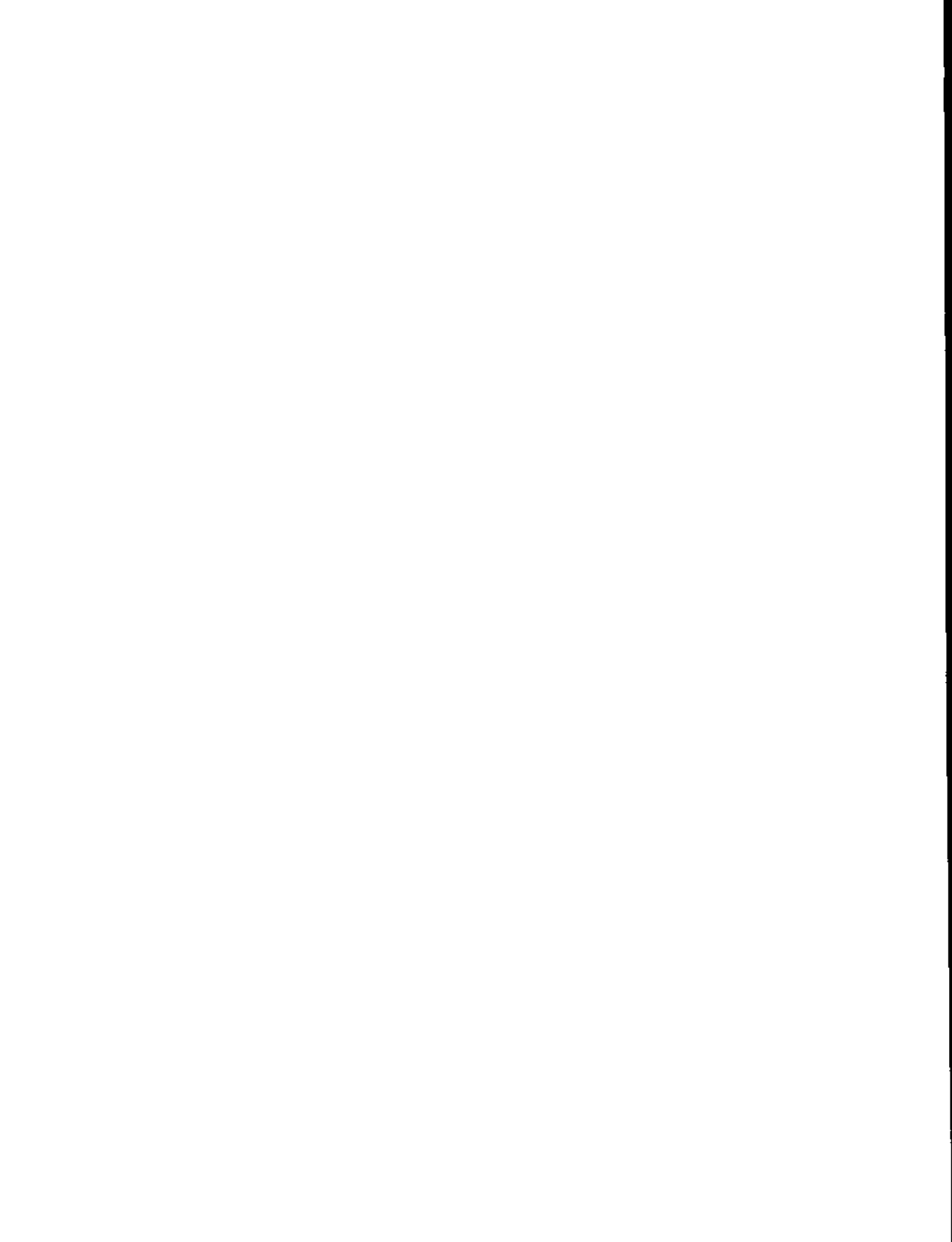

## APPENDIX D

### CONNECTING DEVICES TO THE MICRO DECISION

Figure D-1 shows the connectors on the rear of the Micro Decision. Each connector is designed to have a certain type of device attached to it. This appendix tells you what connects where, and details the options that are available to make the Micro Decision compatible with a healthy variety of devices.

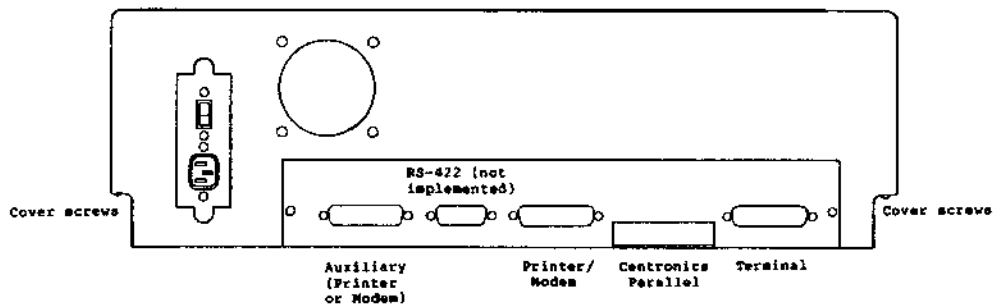

Figure D-1. Micro Decision peripheral connectors

The topics that will be discussed herein are:

- o Serial versus Parallel transmission
- o RS-232 standard connections
- o Centronics-style printer connections
- o Baud rates and communication protocols
- o Using two printers
- o The SETUP program, which controls baud rates, protocols, and printer selection
- o Technical information for configuring non-Morrow modems
- o Technical data on the serial ports and CP/M device definitions

## Types of Transmission

There is a direct relationship between the two classes of data transmission (serial and parallel) and the two different styles of printer connectors on the Micro Decision.

The "lazy D" sockets with 25 little holes in them are known as **serial ports**. The flat plate with the gold stripes on it is a **parallel port**, designed to connect to a parallel printer that conforms to the standards established de facto by the Centronics Corporation. So it is often called a centronics port.

Now then. If you don't know the difference between serial and parallel transmission of data, you may find the rest of this section enlightening. The information presented is not essential to making the proper connections, though.

**Serial transmission** means that a letter or number is sent, say, from your terminal to the Micro Decision in a burst of eleven bits, one after the other. The bits are represented by a voltage going up and down on one of the wires that connects the Micro Decision to its serial peripherals.

The first bit is the "start bit", which alerts whoever is receiving to get ready for the next ten bits. The eight bits after the start bit form a code that represents a letter, number, or special character. The last two bits are "stop bits" that say that the character is finished. (There are variations on this theme, but they go beyond our discussion since they don't apply to the Micro Decision.)

The Micro Decision normally talks to its terminal at 9600 baud, which translates to 9600 bits per second. At 11 bits per character, this boils down to a transmission rate of about 870 characters per second. This speed can be changed to meet the needs of certain terminals, as will be covered when we get to the **SETUP** program.

Terminals and modems always converse with the Micro Decision over serial links; printers, however, may employ serial or parallel schemes.

Parallel transmission takes place when a whole character is sent to and from the computer as a unit, instead of one bit at a time. Of course, you need at least eight wires to carry the individual bits that make up a character, so you'll find that parallel cables are generally more bulky than serial cables. This also explains why the connectors themselves have to be different.

A printer may come with a serial interface, a parallel interface, or both. Printers that are strictly parallel may be cheaper than their serial counterparts because fewer components are involved in processing parallel signals.

Serial transmission does have some definite advantages, however, such as the relative simplicity of the cables. Another is the greater distances that serial communication can reliably cover. But the biggest difference is the fact that the RS-232 serial interface was designed to accommodate two-way communication while the centronics parallel interface is limited to one-way. Hence the latter's employment for printers only.

### **The Serial (RS-232) Connectors**

RS-232 is a standard adopted by the Electronic Industries Association that defines, among other things, which of the pins in the 25-pin serial connector carries what signal. These signals are identified in Appendix E.

When you face the rear of the Micro Decision, the rightmost serial connector is where you attach your terminal. The next connector (labelled PRINTER/MODEM) is available for serial printers, modems, plotters, or networking to other computers. This connector comes configured from the factory for use with printers. There are jumpers inside the Micro Decision that enable it to work with other devices, which we will get to momentarily.

### The Centronics Connector

The 34-pin edge connector is a unidirectional parallel port designed for use with centronics style printers. You will need an adapter cable that connects the edge connector to the standard 36-pin centronics port on the printer. This cable is available from Morrow or at Radio Shack.

Unlike with the serial connectors, it is possible to connect the adapter cable to the edge connector upside down. While no harm results, no good does either. You can be sure that it's right when the ribbon of wires is flowing **downward** out of its connector (see Figure D-2).

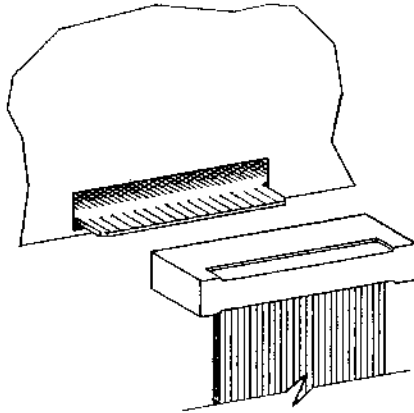

Figure D-2. Connecting the 34-pin plug

### The AUXILIARY Connector

This is an additional RS-232 port that is currently not used by any of the standard Micro Decision software. Programmers can make use of it, but they have to write their own drivers for it. The Morrow MM300 Modem software "ReachOut" and "MicroEZLnk" use this port for the modem, in case you have another serial device attached to the PRINTER/MODEM port.

The pamphlet "Micro Decision Questions and Answers" contains technical data on the AUX port. This pamphlet is available through Morrow Dealer Support.

## The RS-422 Connector

This connector has the same input/output address as the AUX port next to it. It is designed for high speed synchronous communication with other machines, particularly mainframe computers. Morrow's BIOS contains no drivers for this port at present. See also "JP3" on page E-12.

## Crash Course in Baud Rates and Protocol

**Baud Rate** is the speed at which data flows across a serial communications link. **Protocol**, also known as "handshaking", is the system by which the computer and peripheral let each other know if they're ready for data or whether they're too busy at the moment.

There are two basic types of protocol, **hardware handshaking** and **XON/XOFF** (software handshaking). XON/XOFF applies only to serial printers. Parallel printers always use hardware handshaking.

The only judgment you have to make in this regard is whether your serial printer is capable of using XON/XOFF handshaking. This should be clear from the dealer or from the printer's documentation. If it does have this capability, great. If not, this is no problem, but you must make sure that your printer cable has a wire in it connecting pin 20 at the Micro Decision end to the Busy/-Ready pin at the printer end.

The pin number at the printer end varies among brands of printers, so you'll have to check its manual. Typically it is either pin 4, 11, 19, or 20. If a cable is not available off the shelf to meet your needs, you can make one from parts available at Radio Shack or have your dealer make one.

Keep in mind that if you have a parallel printer, it automatically employs hardware handshaking. And if you have a serial printer that can use XON/XOFF handshaking, none of this cable business applies.

The main thing you need to know about the details of baud rate and protocol is that they must be set up symmetrically in the computer and its peripherals. Which brings us handily to the **SETUP** program.



## The SETUP Program

This is a CP/M program that modifies the operating system to reflect these factors:

- A) **The baud rate for your terminal** - If you have a terminal that operates at something other than 9600 baud, or if you are connecting a modem to this port (unusual), you can select 110, 300, 600, 1200, 2400, 4800, or 19200 baud, and later return to 9600.
- B) **Printer Selection** - More will be said about this below, but for now this means you have a fairly convenient way of sending output from an application program to the serial printer one time and to the parallel printer the next.
- C) **The Printer/Modem port (usually equals serial printer) baud rate** - This comes preset at 1200, but you can change it to any of the values listed in "A)" above. If you attach a modem here, the modem's software will probably override whatever settings you select.
- D) **Printer/Modem handshaking** - This is where you specify hardware or XON/XOFF handshaking. The Micro Decision assumes you are using XON/XOFF handshaking unless you use SETUP to tell it otherwise.
- E) **Auxiliary port baud rate** - Most users won't need this, but if you're sending something from a program to CP/M's AUX: device, this is where to set it up. (You usually send program output to the LST: device, which is either the Printer/Modem or Parallel port, depending on how you set "A" above.)
- F) **Auxiliary port handshaking** - See items D and E.

You have the option of making these changes take effect immediately, in which case they stay in effect only until you reboot. The alternative is to make the changes permanent on the CP/M disk so that they are in effect from your next boot until you run SETUP again.

## Using SETUP

To get SETUP running:

1. Escape from the menu system by pressing the **ESC** key at the Co-Pilot Main Menu.
2. At the "A>" prompt, type **setup** and press **RETURN**. The screen in Figure D-3 follows.

### To make changes via SETUP:

Study the screen and locate the change(s) you want to make. Pressing the letter key associated with a function will "toggle" the value of that function. For example, if you press **A** repeatedly, the displayed terminal baud rate switches from 9600 to 110 to 300 and so on, continuing the cycle each time you press the key.

Each of the functions A-F operates in this way, with its own options as noted previously. After you have made all of the changes necessary, press **G** to put the changes into memory (the immediate and temporary route), press **H** to write the changes into the appropriate hard disk file (CPM3.SYS - the deferred but permanent route), and then press **ESCAPE** to return to the A> prompt.

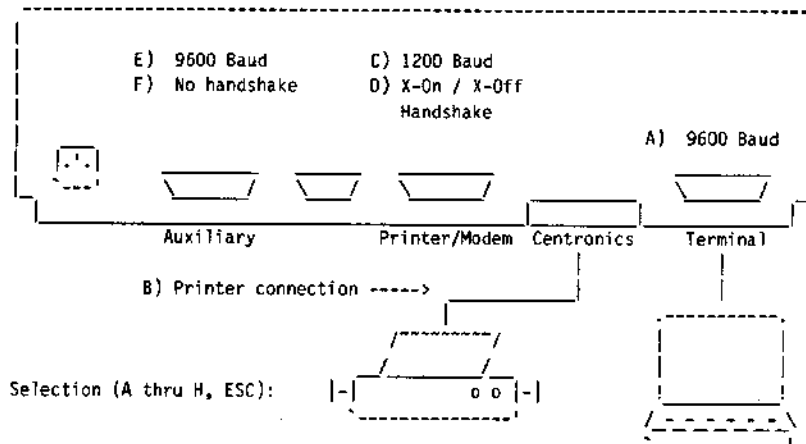

- G) Make temporary changes effective immediately.
- H) Save changes on disk for use after next boot.
- ESC) Exit without any further changes.

**Figure D-3. The SETUP menu**

Example: You got a new serial printer that uses XON/XOFF handshaking and runs at 9600 baud. This is your first run of SETUP, that is, it is still set to its default settings.

1. Verify that the setup switches in the printer are configured for XON/XOFF and 9600 baud. It is likely that the printer has switch options for lower baud rates and other forms of handshaking, but these settings will give optimum results.
2. Get into SETUP as described above.
3. Press **B** to toggle the printer connector from CENTRONICS to PRINTER/MODEM.
4. Press **C** repeatedly to toggle it from 1200 to 9600 baud. If you accidentally go past 9600, keep typing **C**; it will be back.
5. Press **H** to make the changes permanent on the hard disk. "Permanent" is relative, of course, because you could rerun SETUP five minutes later and change it again.
6. Press the RESET button to put the changes into effect.

Special Notes:

If you have a terminal that simply can't operate at 9600 baud (very unlikely), you will have to get your dealer to run SETUP for you with his terminal and your Micro Decision. This will configure the system for a lower baud rate.

When you do this, don't be surprised when "garbage" appears on your screen each time you turn the computer on or press the reset button. This is a garbled version of the message that normally tells what revision level your ROM has. It is sent out at 9600 baud regardless of your SETUP, so your terminal misinterprets it. After you finish booting however, the new baud rate takes over and everything proceeds normally from there.

This implies that you'll never be able to boot from your floppy, because your response of "Y" that tells the Micro Decision to do so must be sent from your terminal at 9600 baud. But since you'd seldom boot from the floppy anyway, this will be an inconvenience only if your hard disk becomes unbootable through malfunction or abuse. Then you'd have to borrow a terminal that works at 9600.

### Using Two Printers

It is conceivable that you may have both a serial and a parallel printer, with one doing high speed matrix output and the other handling slower letter-quality jobs.

Perhaps you want to send the output of a word processing program to the matrix printer, for example, until you reach the final version. Then you want to print it on the daisy-wheel.

If both of your printers are serial (or parallel) and both operate with the same baud rate and protocol, all you would have to do to switch printers is to unplug one and plug the other one in. Even when these unlikely conditions exist, this technique is still tedious and hard on your cable.

In the more probable case of two printers that are not so compatible, and without the benefits of the SETUP program, you would have to get involved in resetting switches inside the computer and possibly having to swap cables.

SETUP function B (Printer select) allows you to switch from serial to parallel printer and back effortlessly. Those of you familiar with CP/M should note that this function establishes the setting of the "LST:" device, while the printer not selected automatically becomes the "PUN:" device.

SETUP function C (Printer baud rate) is useful not only if you have a single serial printer that won't work at 1200 baud, but also if you have two serial printers operating at different baud rates. Then you can switch plugs, run SETUP, and toggle the baud rate (and protocol, if necessary). Note that you would probably want to make changes temporary (the G option) instead of permanent under these circumstances.

## Regarding NewWord and Two Printers

This may run a little outside the scope of this discussion, but here we go. Suppose you are using two printers as described above: one for quick drafts, one for final letter-quality. When you print a document with NewWord or other word processing program, it needs to know what brand and model you're using. (Remember when you first set up the Micro Decision and you selected from a list of printers? Your response was fed to NewWord for this reason.) The model of printer is independent of whether you've run SETUP to choose serial or parallel.

If you selected "Draft" printer way-back-when, both printers will probably work with NewWord. But neither will work at its best. For example, justified text will have uneven spacing between words.

If you selected a particular model, it will probably work very well with that printer, but then it may do crazy things with the second printer. The solution is: When printing with the second printer, in addition to running SETUP (if needed), choose the right "driver" for that printer by pressing Return at the print option questions (e.g. "Number of copies?"). When you get to the last one ("Printer?"), type the abbreviation for the second printer, or just type "draft," if the second printer is the fast, low quality one. If your system included a xeroxed "NewWord Upgrade Notes", it will further discuss this topic.

## Modems

Unless you are using the Morrow Modem MM300, you will have to take the cover off the Micro Decision and rearrange a few jumpers as described in Appendix E. The Morrow modem was specially designed to use the factory settings for the Printer/Modem or Auxiliary port jumpers, that is, the settings that are normally used for printers instead of modems.

Most modems are compatible off-the-shelf with a certain set of software, and vice versa. The MM300, for example, comes with two programs: ReachOut, which is a general-purpose terminal emulator and file transfer package (the type most frequently used with modems), and Micro-ezLNK, which is specially designed to connect with Western Union's EasyLink electronic mail service.

If you buy another modem, for example the Hayes SmartModem, you will also buy software that is matched to that modem. Before you can use the software, you'll have to "install" it by providing it certain information. (You must also install the MM300 programs, but since they are specially matched to the Micro Decision, you don't have to worry about technical details.)

With modems other than the MM300, the details you need are as follows:

#### Port Addresses

Terminal data port = 060H  
Terminal status port = 061H  
Printer/modem data port = 062H  
Printer/modem status port = 063H  
Auxiliary data port = 070H  
Auxiliary status port = 071H

#### Input/Output Controllers

The terminal and printer/modem ports are controlled by a Zilog Z-80 DART (dual UART). The auxiliary port is controlled by a Zilog SIO (serial I/O) chip.

#### Status Bits

The bits that represent Character Ready and Transmit Ready in the controller's STATUS register are:

CHAR RDY = bit 0      TRANSMIT RDY = bit 2

### CP/M Device Definitions

For the technically inclined, the Micro Decision has its logical devices implemented as follows:

CONIN/CONOUT: TERMINAL port  
LSTIN: PRINTER/MODEM (supports XON/XOFF)  
LSTOUT: PRINTER/MODEM or CENTRONICS, depending  
on SETUP  
RDR: PRINTER/MODEM (input)  
PUN: PRINTER (output, supports XON/XOFF)  
or CENTRONICS, depending on SETUP  
AUXIN/AUXOUT: AUXILIARY port

### I/O Ports

The Micro Decision uses all 256 I/O ports. The address lines are decoded to provide nine blocks of ports:

| <u>Range</u> | <u>Name</u>  | <u>Function</u>    |
|--------------|--------------|--------------------|
| 00 - FF      | IO00         | Expansion bank 0   |
| 10 - 1F      | IO10         | Expansion bank 1   |
| 20 - 2F      | IO20         | Expansion bank 2   |
| 30 - 3F      | IO30         | Expansion bank 3   |
| 40 - 4F      | LPORTS-WRITE |                    |
| 50 - 5F      | TIMER        | 8253 counter timer |
| 60 - 6F      | DART         | Dual UART          |
| 70 - 7F      | LPORTS-READ  |                    |

## RS-422 Pin Connections

The RS-422 connector leading from the Modem port is a high speed synchronous serial port. It allows you to send and receive information from a mainframe computer. These are how the pin connections are set:

### RS-422 Pin Connections

1. Transmitted data +
2. Transmitted data -
3. Transmit clock +
4. Transmit clock -
5. Received data +
6. Received data -
7. Receiver clock +
8. Receiver clock -
9. Ground
10. Ground
11. Ground
12. Ground
13. Ground
14. Ground
15. Ground

Received data is sent to the SIO from either the RS-232 or RS-422 AUX connector based on a jumper setting. JP3 is behind the SIO chip, near the AUX connectors. It is set at the factory for the RS-232. Output from the SIO goes in parallel to both connectors.

## The Expansion Connector

While you had the cover off of the Micro Decision, you may have noticed J5, a 40-pin connector near the disk drive connectors. (Some units simply have holes in the circuit board at this location.) This is intended for future use as a connector to circuit boards that provide enhancement functions, such as networks, coprocessors, real-time clocks, and graphics adapters. It is an unbuffered Z80 bus. Designers beware that there are some address decoding conflicts involved in using this bus. Contact Morrow Dealer Support for technical details.





**APPENDIX E**

**MOTHERBOARD JUMPER OPTIONS**

**CONTENTS**

|                                                  |      |
|--------------------------------------------------|------|
| Serial Connector Jumper Options. . . . .         | E-2  |
| Accessing the Jumpers. . . . .                   | E-4  |
| JPA/JPB Factory Settings . . . . .               | E-4  |
| JPA and JPB Settings for Modems. . . . .         | E-6  |
| Factory Settings for JPC . . . . .               | E-8  |
| JPC Settings for Modems. . . . .                 | E-11 |
| JP3 (AUX Port RxD Connector Selection) . . . . . | E-12 |
| JP5 (ROM Message Baud Rate). . . . .             | E-12 |
| The Diagnostics Jumper . . . . .                 | E-13 |



## APPENDIX E

### MOTHERBOARD JUMPER OPTIONS

The Hard Disk Micro Decision motherboard has a number of jumper headers and blocks that determine various aspects of its operation. For most users, none of these are of any concern. For a few users, namely those using external modems other than the Morrow MM300, a certain subset may need to be reconfigured. The same results can be accomplished by wiring the modem cable a certain way.

In any case, if you are not technically inclined, we strongly recommend letting your dealer or a hacker friend reconfigure jumpers for you.

The jumpers we'll discuss, and the details they determine, are:

|            |                                        |
|------------|----------------------------------------|
| JPA        | TERMINAL connector pinouts             |
| JPB        | PRINTER/MODEM connector pinouts        |
| JPC        | AUXILIARY connector pinouts            |
| JP3        | Data-in select between RS-232 & RS-422 |
|            | AUX connectors                         |
| JP5        | ROM boot message at 9600 / 19.2K baud  |
| Unnumbered | Diagnostics mode on boot yes / no      |

JP1 determines how much of memory is shared by both banks, and must be left IN for proper operation of CP/M as configured by Morrow. JP2 is actually bridged by a circuit board trace. If the trace is cut, JP2 determines whether pins 7-9 of JPC are low (normal) or high.

**NOTE:** The following operations involve removing the cover of the Micro Decision and thus should be performed by qualified technical personnel only.

### Serial Connector Jumper Options

Most peripheral options can be handled with the SETUP program. If you want to use a non-Morrow modem on either of your serial ports, however, it may be necessary to reconfigure the pinouts of that port with jumpers contained on the Micro Decision circuit board.

As mentioned previously, the serial connectors on the Micro Decision conform to RS-232 standards. Figure E-1 shows the layout of the connector and Table E-1 identifies the signal associated with each of the pins.

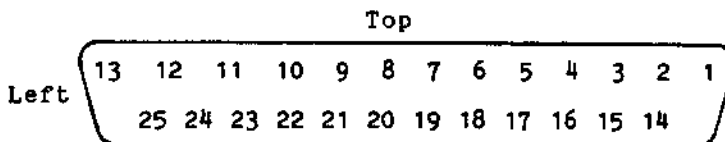

**Figure E-1. Serial Port Pin Arrangement - Rear View**

| Pin # | Signal                    |
|-------|---------------------------|
| 1     | Frame Ground              |
| 2     | Receive Data Input        |
| 3     | Transmit Data Output      |
| 4     | Request To Send Input     |
| 5     | Clear To Send Output      |
| 6     | Data Set Ready Output     |
| 7     | Signal Ground             |
| 8     | Carrier Detect Output     |
| 9 *   | +12V Output               |
| 10 *  | -12V Output               |
| 11 *  | Alternate Handshake Line  |
| 14 *  | +5V Output                |
| 17 *  | Receiver Clock Output     |
| 20    | Data Terminal Ready Input |
| 24 *  | Transmitter Clock Input   |

\* These signals are available on the printer/modem and auxiliary connectors only.

#### **Table E-1. RS-232 Signal Descriptions**

On the circuit board in front of each serial connector is a set of jumper headers labeled JPA, JPB and JPC.

JPA has 8 pairs of jumpers for defining the terminal port; JPB has 9 pairs that define the printer/modem port. JPC has 15 pairs that define the auxiliary port.

Slip-on connectors are used to make the RS-232C pin assignments. By changing the positions of some connectors, the ports can be configured for use with modems. (For those familiar with telecommunications jargon, the jumpers select whether the serial connector is set up to talk to DCE or to DTE equipment.)

## ACCESSING THE JUMPERS

Before you begin, PARK THE HARD DISK, TURN OFF THE MICRO DECISION POWER SWITCH and UNPLUG THE POWER CORD.

Remove the four screws securing the cover to the chassis. Carefully slide the cover towards the front (it is not necessary to remove it completely). Each jumper block is located in front of the related serial port.

### JPA/JPB Factory Settings

You would configure the terminal port for a modem if you wanted to call up the Micro Decision from a remote terminal or computer and use it as if you were connected locally.

The signal present on each jumper pin in JPA and JPB is shown in table E-2 along with the factory setting for the feeding of the signals to the RS-232C connectors. This signal configuration is accomplished through circuit board wiring and the factory jumper settings, as shown in Figure E-2.

| <u>JPA/B Pin#</u> | <u>Signal</u>   | <u>RS-232C Pin#</u> |
|-------------------|-----------------|---------------------|
| (1A)              | RxD to DART     | 2                   |
| (2A)              | RD to device    | 3                   |
| (3A)              | DSR to device   | 6                   |
| (4A)              | DSR/ to DART    | 4                   |
| (5A)              | DTR from device | 20, 5               |
| (6A)              | DTR/ from DART  | 20, 5               |
| (7A)              | +12V            | 8                   |
| (8A)              | +12V            | 8                   |
| (9A) *            | +12V            | 8, 11               |
| (9B) *            | DET from device | 8, 11               |
| (8B)              | CTS/ to DART    | 8                   |
| (7B)              | CD from device  | 8                   |
| (6B)              | CTS to device   | 20, 5               |
| (5B)              | CTS/ to DART    | 20, 5               |
| (4B)              | RTS from device | 4                   |
| (3B)              | RTS/ from DART  | 6                   |
| (2B)              | TxD from DART   | 3                   |
| (1B)              | TD from device  | 2                   |

\* JPB only

**Table E-2: JPA/B Pinouts (Terminal Setup - DTE)**

|      |      |   |   |      |                 |
|------|------|---|---|------|-----------------|
| TD   | (1B) | ○ | ○ | (1A) | RD/             |
| TD/  | (2B) | ○ | ○ | (2A) | RD              |
| RTS/ | (3B) | ○ | ○ | (3A) | DSR             |
| RTS  | (4B) | ○ | ○ | (4A) | DSR/            |
| CTS/ | (5B) | ○ | ○ | (5A) | DTR             |
| CTS  | (6B) | ○ | ○ | (6A) | DTR/            |
| CD   | (7B) | ○ | ○ | (7A) | +12V            |
| CTS/ | (8B) | ○ | ○ | (8A) | +12V            |
| DET  | (9B) | ○ | ○ | (9A) | +12V (JPB ONLY) |

**Figure E-2. Factory Jumper Settings for JPA/B**

When setting up JPA or JPB for use with a modem, the jumper modifications depend on whether your modem cable has pin 2 at one end tied to pin 3 at the other, and vice versa. This crisscrossing is frequently, but not always, found in modem cables. If you're not sure which type you have, use an ohmmeter or continuity tester to find out.



### JPA and JPB Settings for Modems

For cables that crisscross pins 2 and 3, arrange the jumpers as shown below.

|      |      |           |      |      |          |
|------|------|-----------|------|------|----------|
| TD   | (1B) | ○ ○       | (1A) | RD/  |          |
| TD/  | (2B) | ○ ○       | (2A) | RD   |          |
| RTS/ | (3B) | ○   ○     | (3A) | DSR  |          |
| RTS  | (4B) | ○   ○     | (4A) | DSR/ |          |
| CTS/ | (5B) | ○   ○     | (5A) | DTR  |          |
| CTS  | (6B) | ○   ○     | (6A) | DTR/ |          |
| CD   | (7B) | : ○   ○ : | (7A) | +12V |          |
| CTS/ | (8B) | : ○   ○ : | (8A) | +12V |          |
| DET  | (9B) | ○ ○       | (9A) | +12V | JPB ONLY |

For cables that connect pin 2 to pin 2 and pin 3 to pin 3, set your jumpers as shown in the next diagram.

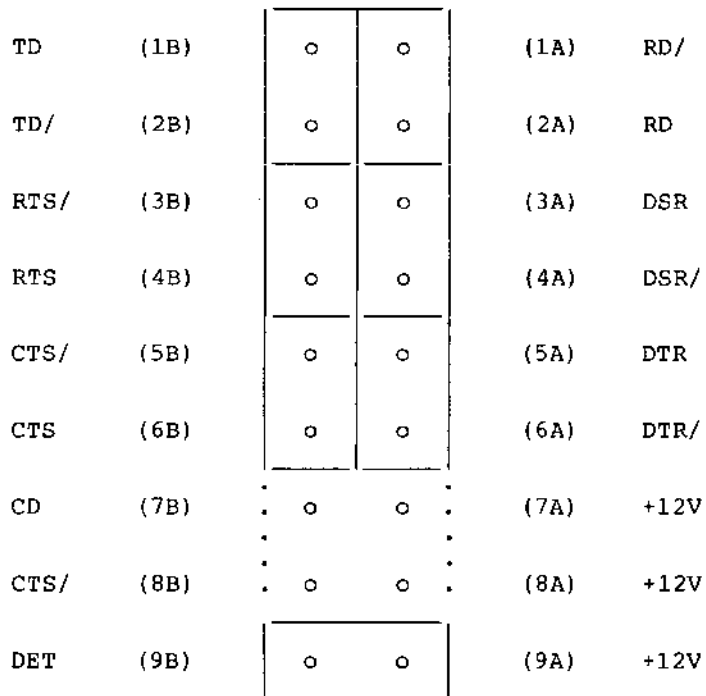

### Factory Settings for JPC

The Auxiliary port would be configured for a modem if you want to use the Micro Decision as a terminal contacting remote computers or data bases.

NOTE: The Auxiliary port comes from the factory configured as DTE; with most modems you have to change jumper settings on JPC as well as installing the software for this port. However, with Morrow's MM300 modem and ReachOut software, neither operation is required.

The signal present on each jumper pin in JPC is shown in table E-3, along with the factory setting for the feeding of the signals to the RS-232C connector. The signal configuration is accomplished through circuit board wiring and the factory jumper settings, as shown in Figure E-3.

| <u>JPC Pin#</u> | <u>Signal</u>             | <u>RS-232C Pin#</u> |
|-----------------|---------------------------|---------------------|
| (1A)            | RxD to ZSIO               | 2                   |
| (2A)            | RD to device              | 3                   |
| (3A)            | DSR to device             | 6                   |
| (4A)            | CD to ZSIO                | 4                   |
| (5A)            | DTR from device           | 20                  |
| (6A)            | DTR/ from ZSIO            | 5                   |
| (7A)            | TTL false (<-3V)          | 8,11                |
| (8A)            | TTL false                 | 8,11                |
| (9A)            | TTL false                 | 8,11                |
| (10A)           | Receiver clock to device  | 17                  |
| (11A)           | RS-232 Receiver input     | N/C                 |
| (12A)           | TTL output of RS-232 rcvr | N/C                 |
| (13A)           | Transmit clock to RS 422  | N/C                 |
| (14A)           | Transmit clock to ZSIO    | N/C                 |
| (15A)           | Transmit clock to ZSIO    | N/C                 |
| (15B)           | Receiver clock to ZSIO    | N/C                 |
| (14B)           | RS 422 receiver clock     | N/C                 |
| (13B)           | Baud clock output         | N/C                 |
| (12B)           | Rcvr clock input to ZSIO  | N/C                 |
| (11B)           | TC (external clock)       | 24                  |
| (10B)           | RS-232 level clock out    | N/C                 |
| (9B)            | DET (alternate handshake) | 8,11                |
| (8B)            | CTS/ to ZSIO              | 20                  |
| (7B)            | CD from device            | 8,11                |
| (6B)            | CTS to device             | 5                   |
| (5B)            | CTS/ to ZSIO              | 20                  |
| (4B)            | RTS from device           | 4                   |
| (3B)            | RTS/ from ZSIO            | 6                   |
| (2B)            | TxD from ZSIO             | 3                   |
| (1B)            | TD from device            | 2                   |

**Table E-3: JPC Pinouts (Modem Setup - DCE)**

|       |       |   |   |       |      |
|-------|-------|---|---|-------|------|
| TD    | (1B)  | ○ | ○ | (1A)  | RD/  |
| TD/   | (2B)  | ○ | ○ | (2A)  | RD   |
| RTS/  | (3B)  | ○ | ○ | (3A)  | DSR  |
| RTS   | (4B)  | ○ | ○ | (4A)  | DSR/ |
| CTS/  | (5B)  | ○ | ○ | (5A)  | DTR  |
| CTS   | (6B)  | ○ | ○ | (6A)  | DTR/ |
| CD    | (7B)  | ○ | ○ | (7A)  | <-3V |
| CTS/  | (8B)  | ○ | ○ | (8A)  | <-3V |
| DET   | (9B)  | ○ | ○ | (9A)  | <-3V |
|       | (10B) | ○ | ○ | (10A) |      |
|       | (11B) | ○ | ○ | (11A) |      |
| RxCB  | (12B) | ○ | ○ | (12A) |      |
| U2CLK | (13B) | ○ | ○ | (13A) |      |
|       | (14B) | ○ | ○ | (14A) |      |
|       | (15B) | ○ | ○ | (15A) |      |

Figure E-3. Factory jumper settings for JPC

### JPC Settings for Modems

Keep in mind that you don't need to reset the jumpers if you're using a Morrow Modem with its supplied software.

The jumper settings for JPC depend upon the type of modem cable you have. For cables that crisscross pins 2 and 3, arrange the jumpers as shown in the next figure.

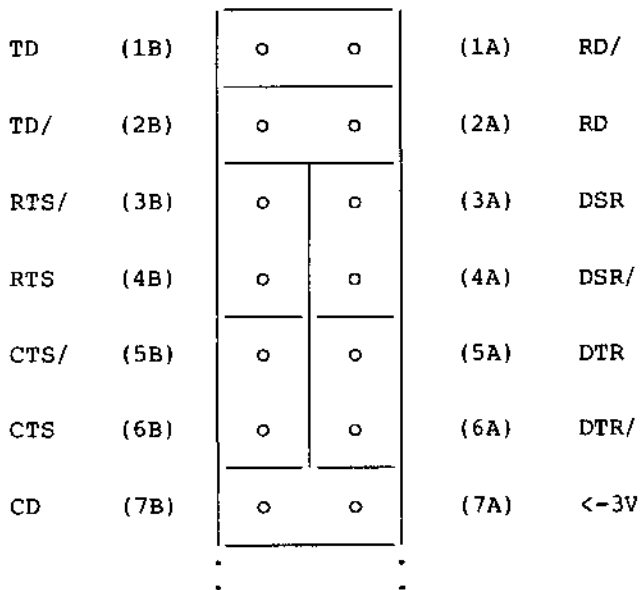

(The rest are the same as factory.)

When using a modem cable that connects pin 2 to pin 2 and 3 to 3, the jumper setup is the same as above except for positions (1A), (2A), (2B), and (1B). See the difference below.

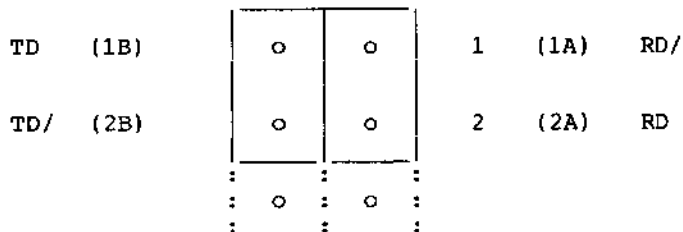

### JP3

JP3 is a 3-pin header located between the Z80 SIO chip and the RS-232 AUX connector. It determines whether inbound data to RxD of the SIO comes from pins 5 and 6 of the RS-422 Aux connector, or pin 2 of the RS-232 Aux connector.

Z80 SIO

o o o  
  \  
  /

Factory setting: Received data to SIO from RS-232

AUX  
Connectors

### JP5

JP5 is a two-pin header between U53 and U54, toward the center of the board. If it is unjumpered, any pre-boot ROM messages are sent to the console at 9600 baud. These include "Testing memory", the ROM version number message, the ROM diagnostics, and "Do you want to boot from the floppy?"

This baud rate is in effect until CPM3.SYS is loaded during the boot process. Then the baud rate contained there, as configured by the SETUP program, takes over.

With JP5 jumpered, these messages are transmitted at 19,200 baud.

The default post-boot console baud rate in CPM3.SYS and CPM3F.SYS is 9600. If this has not been changed by SETUP, jumpering JP5 changes the default to 19,200. If it has been changed with SETUP, the baud rate changes during boot to whatever value was selected with SETUP.

In short, if you want your terminal to run at 19,200 baud, you can run SETUP only, in which case the ROM messages are garbage and you can't respond to "Do you want to boot from the floppy?" if needed. Or you can install a jumper on JP5. Then it won't really matter whether you run SETUP to change the terminal baud rate to 19.2K .

Note to novices: You also have to set the terminal's baud rate switches for 19,200. This can have a noticeable positive impact on some NewWord operations in particular.

### **The Diagnostics Jumper**

This is a two-pin header that has no JP number. It is located next to U22 towards the center of the motherboard.

When jumpered, the Micro Decision displays a diagnostics menu immediately on power-up or a reset. The available options include barber-pole output patterns to the serial and parallel ports. There is also a loop test on the printer/modem port. Finally is an infinite loop memory test that is identical to the normal power-up memory test. The diagnostic operations are fully described in the Hard Disk Micro Decision Service Manual.

Secondly, with the jumper in place, any CP/M disk error messages are accompanied by a more-specific error code, as a diagnostic tool. The error codes are listed and defined in the Hard Disk Micro Decision Service Manual.

This jumper is meant to be in place only while the Micro Decision is being serviced.





## APPENDIX F

### GLOSSARY

**ABORT** - To stop an operation in the middle. Often accomplished with CTRL-C. Also associated with disk error options ("A to abort").

**ALLOCATE** - Assignment of space or function for a specific task. Usually applied to memory or disk space.

**APPLICATION PROGRAM** - Usually a commercially available program that tells the computer how to do a specific job, such as word processing or payroll accounting. Sometimes called "business program" in this manual.

**BACKUP COPY** - A copy of files (programs or data) kept as a spare in case the original file is destroyed. Made with Backfield or PIP.COM.

**BAUD RATE** - Rate of character (byte) transmission speeds over serial communication lines, for devices such as printers, terminals and modems. One character per second = 10 baud.

**BDOS** - The part of CP/M that controls the disk drives (Basic Disk Operating System). Stays in memory whenever CP/M has been booted.

**BIOS** - The part of CP/M that deals with I/O devices like the terminal and printer (Basic Input / Output System). Stays in memory whenever CP/M has been booted.

**BIT** - A contraction of "binary digit;" the basic unit of information used by the computer. Eight bits equals one byte (see BYTE).

**BOOT** - Short for "bootstrap," refers to process whereby the Micro Decision loads CP/M from a "boot disk" (usually the hard disk) into memory. Occurs when you turn the computer on or press its RESET button.

**BUILT-IN COMMANDS** - See also CCP. These are the commands (e.g. DIR) that can be entered at the system prompt without a relevant .COM file being present on the current disk.

**BYTE** - The representation of a single character. A sequence of eight bits treated as a single unit; also the smallest addressable unit within the system.

**CAPACITY** - Amount of data that can be stored on a magnetic storage device (diskette, for example); usually described in terms of k bytes, where one k = 1024 bytes.

**CCP** - Console Command Processor, the part of CP/M that displays the system prompt (A>) and interprets commands. CCP contains the "built-in" CP/M commands. Unlike BIOS and BDOS, CCP comes and goes in memory. It disappears while a program or "transient" utility is run.

**CENTRONICS** - Another term for Parallel, as in serial vs. parallel printers. Borrowed from a brand name of a popular model of parallel printer. See Parallel.

**CHARACTER** - Synonymous with byte. One character is made up of 8 bits. Usually means a letter or number in a data file, but can also refer to non-letters in program files.

**CHIPS** - Also called "IC's" (integrated circuits), small (about 3/8 inch square) pieces of silicon that contain computer logic and circuitry for processing, memory and input/output functions. Chips are connected together on a printed circuit board to form the microcomputer.

**COM FILES** - Those ending in ".COM", for Command file. This file type indicates a program that CP/M can run if you type its first name at the system prompt. For example, the main NewWord program file is NW.COM. To run it, enter NW at the system prompt.

**COMMAND** - Instruction entered by the user at the terminal keyboard to direct the actions of the computer. Contrast with Program.

**COMPATIBILITY** - The ability of one computer to accept and process data by another computer without modifying the data or the media upon which it is being transferred.

**CONFIGURATION** - A group of devices (such as terminals, printers, disk drives, etc.) connected to a computer that has been programmed to operate them as a single system. Controlled primarily by the SETUP program, plus INIT, and various software installation programs like NWINSTAL.COM.

**CONTROL CODES** - Special characters sent by a program to your terminal to get it to behave a certain way (e.g. ring terminal bell). Not discussed at all in this manual. See your terminal manual.

**CONTROL KEYS** - Sequence of keystrokes entered at the keyboard to initiate a particular function within a program. Usually involves holding down the CTRL key while tapping some letter key.

**CPU** - Central Processing Unit. The "brains" of the computer where instructions and data are interpreted and executed.

**CURRENT DISK** - The disk whose letter appears in the system prompt. CP/M will search this disk for any program name that's been entered at the system prompt. Also called "Default disk" and "Logged disk".

**CURSOR** - Indicates position on the terminal screen; may be a small rectangle or underline. May blink. Can be modified by the technically inclined.

**CURSOR KEYS** - See Function Keys.

**DATA** - The facts, numbers, letters, symbols, etc. processed or produced by the computer. A memo is data to the NewWord program.

**DEFAULT DISK** - See Current Disk.

**DISK STORAGE** - Storing of data on magnetic disk. Data is arranged on concentric tracks much like a phonograph record.

**EMULATION** - The ability of certain devices to behave exactly like similar devices of different brands. Usually associated with terminals and printers. Emulation details often depend on switch settings in the device. This capability is needed because different brands and models often recognize different control codes and escape sequences. See also Installation.

**ENTER** - As in "enter this command", means typing the command, and then "entering" it with the RETURN key. Usually a computer waits for the RETURN character before attempting to execute the command.

**ERASE** - Complete removal of data from a disk or other data storage device.

**ERRORS** - Messages interrupting the normal flow of processing. May be due to mistyped commands, or may be due to hardware problems.

**ESCAPE SEQUENCES** - Similar to control codes, these are sent from a program to the terminal, for functions like cursor movement and reverse video. See your terminal manual.

**EXECUTE** - The act of carrying out a command.

**FILE** - A single named collection of data, such as a manuscript or a list of addresses, that can be recalled by the computer. Disk directories show file names. Individual NewWord documents are distinct files. Running the NewWord program involves several program files.

**FIRMWARE** - Specific software instructions permanently placed into the computer's ROM memory chips.

**FLOPPY DISKETTE** - Small, flexible disks that store magnetically encoded data used on the microcomputer.

**FOREIGN DISKETTES** - Diskettes that are in formats other than Micro Decision format. Morrow provides a program called FOREIGN that allows the MD to read or write in some of these other formats.

**FORMAT** - Layout of information on a disk that the operating system expects before it can read and write information to and from the disk. With CP/M, different brands of computers can each have their own distinct disk formats.

**FULL DUPLEX** - A type of serial transmission whereby both devices have a wire for transmitting. When in duplex mode, a character typed on your keyboard goes to the computer and is bounced back to your screen.

**FUNCTION KEYS** - On the terminal's keyboard, those labelled F1, F2 etc. Also includes keys with arrows, and perhaps others. Very unpredictable in the codes they generate, usually a piece of intermediate software like KEY.COM is needed to translate them into anything useful.

**HANDSHAKE** - Sometimes called protocol, the method by which computers and devices let each other know when they're too busy to communicate with each other. Hardware handshaking involves changes of voltage on a handshake wire in the serial cable, software or "XON/XOFF" handshaking uses no such wire, instead, special start-stop characters are sent across the regular transmission wires.

**HARD DISK** - Hermetically sealed rigid disk that is functionally comparable to a floppy disk, but it stores much more and can access the information much faster. The disk itself is not removable.

**HARDWARE** - Contrasts to software; the physical computer equipment and components, such as the magnetic, electronic and mechanical devices.

**HARDWARE HANDSHAKING** - See Handshake.

**INPUT** - Data entered into the computer to be processed, usually from the keyboard.

**INSTALLATION PROGRAMS** - Accompany most business programs, these tailor the program to your hardware and working style. See NWINSTALL in the NewWord User's Guide. The Co-Pilot menus handle these for you with Morrow software. Among other things, installation decides what control codes and escape sequences are correct to use with your peripherals.

**I/O** - Input/Output; refers to acceptance and transfer of data to and from a computer.

**I/O DEVICES** - Devices used to communicate with the computer and transfer data to and from it. See Serial and Parallel.

**INSTRUCTION** - Statement in a computer program specifying a particular function or task to be performed.

**INTERFACE** - The connection between two devices, specifically which wire carries what signal, and how strong the signal should be.

**JUMPER** - Vertical pins on the Micro Decision circuit board that can be bridged or not by "shunt blocks". Jumpers provide technical options in various operations of the MD, primarily the configuration of the serial ports.

**K** - Taken from Greek word "kilo" meaning 1000; equivalent to 1024, or 2 raised to the 10th power (see BYTE).

**LANGUAGE** - A means of conveying information to the computer that is governed by a set of defined rules and conventions. PILOT and MBASIC are languages. All programs are written in one or another language. For the MD, most are written in Z80 assembly language.

**LOGGED DISK** - See Current Disk.

**LOGGING ONTO A DISK** - Enter a command at the system prompt to change the current disk drive. Command takes the form "X:", where X is the actual drive letter.

**MASS STORAGE** - Storage devices that hold large amounts of information, usually disk drives; cassettes and streaming tape are also examples.

**MICRO DECISION** - The computer unit that contains the CPU circuit board, hard disk, floppy disk drive, and power supply.

**MODEM** - Contraction of MODulator-DEModulator; communication device that transmits information between computers via telephone lines. Connect to computer similar to serial printer.

**OPERATING SYSTEM** - An operating system has many important functions in a computer system. It is a collection of instructions and software programs that link the user to the computer, allowing him to work efficiently with it. It also controls the operation of the system, taking care of command and program execution, displaying error messages at the appropriate times, directing data to the proper places, etc. The Micro Decision operates with the CP/M operating system. See also BDOS, BIOS, CCP, Built-in Programs, and Transient Programs.

**PARALLEL** - As in "parallel transmission" and "parallel printer", transmission of data eight bits at a time across eight wires. Contrast with Serial.

**PERIPHERALS** - Devices aside from the computer, used for input and output. Printers, terminals, and modems are peripherals; even disk drives are, in a stricter sense.

**PORT** - Logical and physical devices through which the Micro Decision communicates. Example of logical port is LST:, usually meaning printer. Programs like NewWord talk to LST:. CP/M's BIOS translates this into a "port address", or the address code for an I/O controller chip in the computer. The chip is hard-wired to one of the connectors on the rear of the Micro Decision. Thus the connectors can be regarded as physical ports, giving rise to expressions like "terminal port" and "parallel port".

**PRINTER** - An output device that produces a "printout" or "hard copy" of computer data. Output is measured in the quality of print weighed against number of characters per second. Letter quality printers win the quality contest, dot matrix printers are faster, and laser printers are much faster than both and equal to letter quality.

**PROFILE.SUB** - A special submit file that, if present on the boot disk in user 0, is automatically executed after booting. As shipped, Morrow's PROFILE.SUB sets up the command search path (see SETDEF) and runs the Co-Pilot Menu System. PROFILE.SUB can be changed with NewWord or can be eliminated entirely.

**PROTOCOL** - See Handshake.

**RAM** - Random Access Memory; high speed memory locations inside the Micro Decision. MD has 128,000 bytes of RAM. RAM holds programs like NewWord and its data only while they are running. Information in RAM disappears when you reset the Micro Decision or turn it off.

**RESET** - Process by which the Micro Decision abandons what it was doing and reloads CP/M. See Booting. Occurs whenever you turn the unit on or press the RESET button on its front panel.

**ROM** - Read-Only Memory, has certain essential computer instructions permanently "burned" into the ROM chip. MD has 8,000 bytes of ROM. ROM information stays intact even with power turned off.

**RS-232** - A specification established by the Electronic Industries Association governing the interface requirements between serial devices (terminals, modems, and printers), and computers.



**SERIAL** - As in "serial printer", this means transmission of data takes place across a single wire, one bit at a time. See Baud Rate. Contrast with Parallel.

**SETDEF** - A command that tells CP/M where to look for .COM or .SUB files, if they are not on the current drive. A SETDEF command is automatically fed to CP/M when you boot. See PROFILE.SUB.

**SOFTWARE** - The programs that govern the operation of the computer and make the hardware run. Operating system (CP/M) and application programs like NewWord are both software.

**SOFTWARE HANDSHAKE** - See Handshake.

**SUBMIT FILES** - Those ending in ".SUB", these contain regular CP/M instructions like FORMAT, which are executed automatically in sequence. SUBMIT.COM handles this processing. To run SAMPLE.SUB, enter SUBMIT SAMPLE at the system prompt. (With the standard SETDEF line in Morrow's PROFILE.SUB, you don't even need to enter SUBMIT as part of the command.)

**SYSTEM PROMPT** - Also called "A-prompt" or "B-prompt", reflecting letter in the prompt. Takes the form onscreen of "A>". Signals that CP/M is ready for a command or program. Letter and number in prompt show current disk drive and user number (e.g. 12B>).

**TERMINAL** - A typewriter-like keyboard and display screen connected to the computer for input/output of data.

**TRANSIENT PROGRAMS** - Any program that is not built into CCP, that is, it has its own .COM file on a disk. Thus NewWord is a transient program. Usually the term is limited to CP/M housekeeping programs like SUBMIT.

**USER NUMBERS** - Logical (not physical) subdivision of a disk. Each disk has 16 user numbers, 0-15. Originally intended for a computer that is shared by several people, are more useful to organize many files for a single user.

**WARM BOOT** - Occurs when exiting from .COM programs like NewWord or FORMAT, when CCP is loaded back into memory and the system prompt reappears onscreen. Contrast to cold boot (power up or reset), where all of CP/M is reloaded.

**XON/XOFF HANDSHAKE** - See Handshake.

A to Abort, see Abort Option  
 A> prompt, 2-13, 2-21, 4-4  
     see also System prompt  
 Abort option (disk errors), 5-4, 5-7  
 Aborting programs with CTRL-C, 2-7  
 Adding new software, 4-29  
 Application programs, 3-1  
     running from CP/M, 4-21  
 Arithmetic functions, 6-19  
 Arrow keys, see Cursor keys  
 Attributes, 2-15  
     system, 4-7  
 Automatic startup commands  
     (PROFILE.SUB), 3-7  
 AUX: device, D-6, D-12  
 AUXILIARY connector, D-4  
     factory jumper settings, E-8, E-10  
     jumper options, E-1  
     modem jumper settings, E-11  
     received data jumper (JP3), E-12  
     setup, 3-5  
     signal descriptions, E-9  
     see also Connectors and Serial

Back panel connections, 6-7  
 BACK SPACE key, 6-18  
 Backfield  
     Backfield Options Menu, 2-10  
     confusion factors, A-1  
     detailed discussion, A-1  
     first full backup, 2-10  
     module descriptions, A-5  
     reference guide, A-10  
     reference summary, A-43  
     technical examples, A-39  
     tutorial, A-6  
     utility programs, A-38  
     vs. PIP, 4-9  
     Working Diskette, 3-13, 4-8, 4-10, A-1  
 BACKUP program (for diskettes), 3-1, 3-7  
 Backup programs, hard disk, see Backfield  
 BACKUP.DSK file, 3-7  
 Badmapping, 5-6  
 BAK (NewWord backup) files, 2-22  
 BASIC, running from CP/M, 4-21  
     see also MBASIC  
 Baud rate, 1-10, D-2  
     explained, D-5  
     ROM messages, E-12  
     serial printer, 1-18  
     SETUP options, 3-5  
 BDOS, 4-19  
 BIOS, 4-19  
 BIOS source, 3-1, 3-14  
 BIOS.SUB file, 3-14

Bits, in communication, D-2  
 BNKBIOS3.MAC file, 3-1, 3-14  
 Bookkeeping program, see Quest  
 Booting from the floppy, 1-16, 3-12, 4-7  
 Booting  
     automatic commands, 3-6  
     general discussion, 4-19  
 Bugs, 5-1  
 Built-in commands, 4-24  
 Business programs, 3-1  
 Bytes, 6-3

Cable  
     keyboard, 1-7  
     parallel printer, 1-7, D-5  
     serial printer, 1-7, D-5  
     terminal, 1-6  
 Calculator keypad, 6-19  
 CAPS LOCK key, 6-17  
 CCP, 4-19, 4-24  
 Central Processing Unit, 6-3  
 CENTRONICS PARALLEL connector, D-i - D-4  
     see also Connectors and Parallel  
     setup, 3-5  
 Chaining in key definition files, B-14  
 Characters, see Bytes  
 Check Space and File Size  
     (Utility Menu), 2-19, 4-23  
 Co-Pilot Backfield Options Menu, 2-10  
 Co-Pilot menus, 6-16  
     disabling, 3-7, 4-14  
     Main Menu, 1-15, 2-2, 6-17  
     modifying, 4-14  
     not the same as PILOT, 3-5  
     restoring, 4-15  
     returning to from CP/M, 1-18, 2-13  
     translating, 4-15  
 Co-Pilot Utility Menu, 2-14  
     CP/M equivalents, 4-23  
 Command syntax, 5-2  
 Command  
     executing, 6-17  
     entering from CP/M, 3-15, 4-15, 4-21  
     running from Utility Menu, 2-20  
     transient vs. built-in, 4-24  
 Communication, serial vs. parallel, D-2  
 Compatibility with foreign formats, 6-8  
 Compatibility among CP/M software, 4-20  
 CON: device, D-12  
 Connectors  
     and SETUP program, D-6  
     AUXILIARY, 6-7  
     CENTRONICS PARALLEL, 1-8, 3-5  
     keyboard, 1-7  
     locations, D-1

## Connectors, continued

- parallel printers, 1-7
- PRINTER / MODEM, 1-9, 1-18, 3-5, 6-7
- RS-422, D-5
- serial printers, 1-7
- SETUP options, 3-5
- terminal, 1-6, 6-7
- see also Serial, TERMINAL, CENTRONICS, AUXILIARY, and PRINTER/MODEM

Control key commands, 6-18

Control Program for Microcomputers, see CP/M

CONTROL-C command, 2-17, 2-16, 2-20  
after running CP/M command, 2-21

CONTROL-J command, 4-27

CONTROL-L command, 4-28

CONTROL-M command, 4-27

CONTROL-P command, 4-27, 4-28

CONTROL-Q command, 2-16, 6-19

CONTROL-S command, 2-16, 6-19

Copy a file or files (Utility Menu), 2-17, 4-23

Copying diskettes, 3-7, 4-31  
see also BACKUP

Copying files, see PIP

COPYSYS program, 3-1, 3-11, 4-9

Correct-It

- running from CP/M, 4-21
- running through Co-Pilot, 2-7
- trial run, 2-7
- User's Guide, 2-6, 2-7

CP/M commands,

- running from Utility Menu, 2-20

CP/M Distribution Disks, 1-16, 3-13, 4-8

CP/M prompt (A>), 2-21, 4-4  
see also System prompt

CP/M search path, 3-6

CP/M utilities, 3-1

CP/M

- 2.2 vs. 3.0, 4-21
- commands for Utility Menu, 4-23
- CP/M "Plus", 3-8
- device definitions, D-12
- disk drive letters, 4-3
- escaping to, 2-13
- general discussion, 4-18
- learning about, 4-18
- modifying, 3-14
- port addresses, D-12
- returning to menus, 2-13
- running application programs from, 4-21
- simulating version 2.2, 3-8
- software available for, 6-8
- software compatibility, 4-20

## CP/M, continued

- transient vs. built-in commands, 4-24
- tutorial, 2-23
- version 3.0 vs. 2.2, 3-8, C-1

CPM2 program, 3-2, 3-8, 4-21, C-1

CPM2.RSX file, 3-8, C-1

CPM3 program, 3-2, 3-8, 4-21, C-1

CPM3.SYS file, 3-11, 3-12

CPM3F.SYS file, 3-12

CPU, Z80A, 6-3

CTRL (control) key, 2-7, 2-16, 6-18

- See also CONTROL commands

Current disk drive, 2-21, 4-4

Current user number, 2-21, 4-4

Cursor, 1-12

Cursor keys, 6-20

- in DEFAULT.KEY, B-4

- in NW.KEY, B-5

- in SC.KEY, B-7

Data base program, see Personal Pearl

Data Not Found error message, 5-5

Data

- exchanging, 6-7

- explained, 6-2

- saving, 2-6

DataStar anomalies, 3-8

Default disk drives, 4-4

DEFAULT.KEY key definition file, B-4

DEL (delete) key, 6-18

Destination diskette (BACKUP), 3-7

Device definitions, D-12

Diagnostics jumper, E-13

DIR command, 2-20, 3-1, 4-23, 4-24

Directories of disks, 2-5, 2-13, 3-1

- displaying from Utility Menu, 2-14

- interpreting, 2-15

DIRS command, 2-13

Disabling the menus, 4-14

Disk drives, 6-4

- booting from floppy, 4-7

- cardboard inserts, 1-11

- default, 4-4

- detailed discussion, 6-9

- door, 6-14

- latch, 6-14

- letters, 4-3, 5-9, 6-15

- logged drive, 4-4

- logging onto, 4-5

- not ready, 5-4

- possible problems, 5-4

- protecting floppy, 1-11

- "virtual", 6-15

- see also Hard disk, Diskettes, Floppy

## Diskettes

- Backfield, A-1
- backup, A-2
- bootable, 3-11, 4-8
- care of, 6-6
- checking available space, 2-19
- compatible formats, 4-29, 4-31, 6-8
- copying, see also BACKUP
- CP/M format differences, 4-20
- do's and dont's, 6-12
- duplicating, 4-31
- duplicating (BACKUP), 3-7
- formatting, 2-18, 3-3, 6-12
- formatting for Backfield, 2-11
- formatting for MD-2, 2-18
- improperly formatted, 5-5
- in foreign formats, 3-9
- included with system, 1-1
- inserting, 6-14
- labelling, 6-12
- Micro Decision format, 6-8
- physical features, 6-11
- purpose, 6-11
- single vs double sided, 3-4
- source and destination, 3-7
- storing, 6-12
- type needed, 2-10
- type to buy, 6-6
- virtual drives, 6-15
- write protecting, 6-13
- see also Hard disk

Display a directory (Utility Menu), 4-23

Display, pause and resume, 2-16, 6-19

Distribution Disks,  
recopying to hard disk, 1-16

Drive Not Ready error message, 5-4

## Emulation

- printer, 1-3
- terminal, 1-2

ENTER key, 6-18

Equipment Failure error message, 5-5

ERA (erase) command, 4-23, 4-32

ERASE key, 6-20

Erasing characters, 6-18

Erasing files through Utility Menu, 2-22

Error control codes, 5-5

Error messages, 5-1

- Data Address CRC, 5-5
- Data error, 5-5
- Data Not Found, 5-5
- disk operations, 5-3
- Disk Read Only, 5-9
- Drive Not Ready, 5-4
- Equipment Failure, 5-5

## Error messages, continued

- File Read Only, 5-9
- ID Address CRC, 5-5
- Invalid Format, 5-2
- Media Failure, 5-6
- possible responses, 5-6
- Sector Not Found, 5-5
- Seek Error, 5-6
- Select, 5-8
- translating, 4-17
- Unable to Remap, 5-6
- Unknown Error Code, 5-6
- Write Protected, 5-4

Error recovery, 5-7

## Errors

- CP/M commands, 2-20
- nonrecoverable, 5-8
- RAM and ROM, 1-13
- software, 5-1
- summary, 5-9

ESC (escape) key, 2-13, 6-17

Execute a CP/M Command (Utility Menu),  
2-20, 4-23

Executing commands, 6-17

Expansion connector (internal), D-13

Extensions, 4-2

F1 key, see Function keys

Feet for Micro Decision, 1-4

File attributes, 2-15

- see Attributes

File cabinet screen, 2-4

File names, 2-15, 2-22

- disk drive letters, 4-3
- examples, 4-2
- rules, 4-2

File type, 4-2

## Files

- copying with Utility Menu, 2-17
- copying, see also PIP
- directory list, 2-5
- erasing through Utility Menu, 2-22
- explained, 6-3
- extremely large (Backfield), A-3
- open for read/write, 4-1
- printing with Utility Menu, 2-15
- read only (see also SET), 5-9
- renaming from Utility Menu, 2-22
- system attribute, 4-7

Floppies (see also Diskette), 6-4

- booting from, 4-7

FOREIGN program, 3-2, 3-9, 4-20,  
4-29, 4-31

Format a Diskette (Utility Menu),  
2-18, 4-23

FORMAT program, 2-18, 3-2,  
3-3, 4-23, 4-31  
running from CP/M, 3-3

Formats  
compatible, 6-8  
Micro Decision, 6-8

Formatting diskettes, 6-12  
single vs double sided, 3-4  
See also Diskettes and FORMAT

Full restore of hard disk, 4-10

FULLBACK program, 2-11  
messages, A-15  
operational details, A-11  
tutorial, A-6

Function keys  
default definitions, B-4  
general discussion, 6-19  
in NW.KEY, B-5  
in SC.KEY, B-7  
programming (KEY.COM), 3-4, B-1  
reprogramming, B-9  
see also Key definition files

Fundamental Training in CP/M  
(Utility Menu), 2-15, 2-21, 2-23,  
4-18, 4-23, 5-1

GENCOM program, C-3

Glossary, F-1

Halfback  
messages, A-27  
operational details, A-26  
tutorial, A-9

Handshaking  
and SETUP program, D-6  
explained, D-5  
hardware vs. software, D-5  
see Protocol

Hard disk  
adding new software, 4-29  
backup programs, 2-10  
backups See Backfield  
badmapping, 5-6  
booting problems, 4-8  
care and feeding, 6-10  
checking available space, 2-19  
checking condition of, 3-14  
damage in transit, 1-16, 3-13  
damaged, 4-9  
features, 6-9  
formatting, 3-3  
heads, 2-12  
loader program (HDL), 3-13  
parking, 2-2, 2-12, 3-3

Hard disk, continued  
protecting, 2-2  
protecting while moving, 3-3  
restoring, 4-10  
storage capacity, 6-4

Hardware Failure error message, 5-5

Hardware handshaking, D-5

Hardware  
adding new, 4-11  
defined, 6-1  
explained, 6-3  
general information, 6-3  
general specifications, 6-4  
I/O controllers, D-11  
optional, 6-7  
required, 1-1

HDBOOT program, 3-14

HDL (hard disk loader) program,  
3-2, 3-13, 4-9

HDPIP program, 3-14

HELP key, 6-20  
in DEFAULT.KEY, B-4

Help level in NewWord, changing, 4-25

Hewlett Packard format, 3-9, 4-29, 4-31

HOME key, 6-20  
in DEFAULT.KEY, B-4

I to Ignore, see Ignore option

IBM-PC CP/M-86 format, 3-9, 4-31

Ignore option (disk errors), 5-4, 5-8

IMS (in-memory submit) program,  
3-2, 3-10

InfoStar anomalies, 3-8

INIT program, 3-2, 3-10, 4-12

Installation programs, 3-10

Installing the software, 1-14

Invalid Format error message, 5-2

Jumper options, E-1

Kaypro format, 3-9, 4-29, 4-31

Key definition files (.KEY), B-2  
available key names, B-12  
chaining to programs, B-14  
comments in, B-13  
creating new, B-11  
fast vs. slow mode, B-17  
modifying, B-9  
restrictions, B-9  
sample layout, B-9  
special characters, B-13  
special definitions, B-13  
technical notes, B-18

KEY.COM (function key) program, 3-2  
 detailed discussion, B-1  
 version number, B-19  
 see also Function keys

Keyboard  
 arrow keys, 6-20  
 connecting, 1-7  
 cursor keys, 6-20  
 general description, 6-16  
 layout, 6-17  
 numeric keypad, 6-19  
 special symbol keys, 6-19

Keys  
 ALPHA LOCK, 6-17  
 BACK SPACE, 6-18  
 CAPS LOCK, 6-17  
 CTRL, 6-18  
 DELETE, 6-18  
 ENTER, 6-18  
 ESC, 6-17  
 RETURN, 6-18  
 RUB OUT, 6-18  
 SHIFT, 6-17  
 SHIFT LOCK, 6-17

Kilobytes, 6-3

Language, explained, 6-2

Letters, disk drive, 4-3, 6-15

Levels of terminals, 3-10, 4-12, 4-30

Load Quest Bookkeeper (Utility Menu),  
 2-23, 4-23

Logged disk drive, 4-4  
 changing, 4-5  
 meaning, 4-5

Logging onto disks, 2-3, 4-5

LST: device, D-6, D-12

M80 assembler, 3-14

MAC assembler, 3-14

Main Menu, see Co-Pilot

Manuals  
 Correct-It User's Guide, 2-6  
 CP/M User's Guide, 2-21  
 included with system, 1-1  
 NewWord User's Guide, 4-25  
 software, 2-3  
 SuperCalc User's Guide, 2-6

Materials checklist, 1-1

MBASIC, running through Co-Pilot, 2-12

MDINST.PIL file, 4-13, 4-17

MDT-60 terminal  
 function key program, B-1  
 see also MT-70

Media Failure error message, 5-6

Memory test, 1-13

Menus, see Co-Pilot

MICRO.PIL file, 4-15

Modem  
 general discussion, D-10  
 port addresses, D-11  
 RS-232 interface for, 6-7  
 software for, 6-7

MT-70 terminal  
 function key program, B-1  
 function keys, 3-4  
 setting up, 1-10  
 see also Appendix B

Naming files, 4-2  
 See File names

NewWord  
 .BAK (backup) files, 2-22  
 customizing, 4-25  
 exiting from, 2-5  
 function key definitions, B-5  
 installing with NWINSTAL, 4-12, 4-25  
 manual, 2-4  
 merge print information, 2-7  
 Opening Menu, 2-5  
 printer compatibility, 1-3  
 running from CP/M, 4-21  
 running through Co-Pilot, 2-3  
 sample documents, 2-5  
 sample key definition file, B-9  
 saving data, 2-6  
 trial run, 2-3  
 with two printers, D-10

No Scroll key, 2-16, 6-19

Numeric entries, 6-19

Numeric keypad, 6-19  
 as function keys, B-16

NW.KEY key definition file, B-5  
 sample layout, B-9

NWINSTAL program, 4-12, 4-25

ON-LINE switch, 1-19

Operating system  
 defined, 6-2  
 see also CP/M

Osborne format, 3-9, 4-29, 4-31

Packing materials, 1-4

Parallel port, D-1  
 setup, 3-5  
 See also CENTRONICS

Parallel printers, D-4  
 connecting, 1-7, D-4

Parallel transmission, D-2

Parity, 1-10

- PARK program, 2-2, 3-2
  - running from CP/M, 3-3
  - running from floppy, 4-10
  - running through Co-Pilot, 2-12
- Parking area, 2-12
- Path for file searches (SETDEF), 3-6
- Periods in file names, 4-2
- Personal Pearl
  - exiting from, 2-8
  - running from CP/M, 4-21
  - running through Co-Pilot, 2-8
  - trial run, 2-8
- Physical arrangement, 1-5
- PILOT program, 3-2, 3-5
- PIP program, 2-15, 2-17, 3-12, 4-6, 4-23, 4-27, 4-30, 4-32
  - for backups, 4-9
- Port addresses, D-11, D-12
- Ports, see Connectors
- Power cords, 1-12
- Power requirements, 1-12
- Power switch, 1-12
- Printer cables, D-5
- Printer connections, 6-7
- PRINTER/MODEM connector, D-1
  - factory jumper settings, E-4
  - jumper options, E-1
  - modem jumper settings, E-6
  - setup, 3-5
  - see also Connectors
- Printers
  - adding new, 4-11
  - communication specifications, 1-17
  - compatible with NewWord, 1-3
  - connecting, 1-7
  - connecting parallel, D-4
  - dot matrix, 6-7
  - letter quality, 6-7
  - serial, 1-15
  - serial setup, 1-17
  - serial vs parallel, 4-11
  - serial vs. parallel, 1-7
  - using two, D-9
- Printing and typing simultaneously, 4-26
- Printing what's onscreen, 4-28
- Printing, aborting, 4-1
- PROFILE.SUB file, 3-2, 3-6, 4-14
- Programming languages, 6-2
- Programs
  - application, 6-2, 6-8
  - communication, 6-8
  - CP/M 2.2 vs. 3.0, C-1
  - explained, 6-2
  - running from .KEY files, B-14
- Programs, continued
  - running from CP/M, 3-15, 4-5, 4-21
  - see also Software
- Protocol
  - serial printer, 1-18
  - SETUP options, 3-5
  - see also Handshaking
- PUN: device, D-12
- Quarterback
  - messages, A-22
  - operational details, A-19
  - tutorial, A-8
- Quest
  - adding to hard disk, 2-23
  - enhancements, 2-25
  - exiting from, 2-9
  - function key definitions, B-8
  - installing, 2-24
  - multiple copies, 2-24
  - registration fee, 2-9, 2-24
  - running from CP/M, 4-21
  - running through Co-Pilot, 2-9
  - trial run, 2-9
- Questions and answers, 4-1
- R to Retry, see Retry Option
- RAM, 6-3
- RAM Error message, 1-13
- Random Access Memory, see RAM
- RDR: device, D-12
- Read Only error message, 5-9
- REN (rename) command, 4-16, 4-23
- Rename or Erase a File (Utility Menu), 2-22, 4-23
- Renaming files, reasons for, 2-22
- RESET button, 1-16, 2-1
  - printer lockup, 2-5
  - when and when not to use, 4-1
- Restore (Backfield module)
  - messages, A-32
  - operational details, A-30
  - tutorial, A-9
- Retry option (disk errors), 5-4, 5-7
- RETURN key, 6-18
- ROM Error message, 1-13
- ROM messages
  - baud rate, E-12
- RS-232, see Serial
- RS-422 Connector, D-5
  - pinouts, D-13
  - received data jumper (JP3), E-12
- Rubber feet, 1-4
- RW (read/write) attribute, 2-15, 2-19

SC.KEY key definition file, B-7  
 Scrolling, pause and resume, 2-16  
 Search path, 3-6, 4-5  
 Sector Not Found error message, 5-5  
 Seek Error message, 5-6  
 Select (Backfield module)  
   messages, A-36  
   operational details, A-34  
   precautions, A-35  
   tutorial, A-9  
 Select Error message, 5-8  
 Serial connectors, D-3  
   jumper options, E-2, E-3  
   pin arrangements, E-2  
   setup, 3-5  
   signal descriptions, E-3  
   see also TERMINAL, PRINTER/MODEM,  
   and AUX  
 Serial printers, 1-15  
   connecting, 1-7  
   possible problems, 1-19  
   setting up, 1-17  
 Serial transmission, D-2  
 SET command, 2-15, 2-21, 4-16, 4-25, 5-9  
 SETDEF command, 3-6  
 SETUP key, 6-20  
 SETUP program, 1-10, 1-17, 3-2,  
   3-4, 4-12, D-2  
   details, D-6  
   general use, D-7  
 SHIFT key, 6-17  
 SHOW program, 4-23, 4-24  
 Software handshaking, D-5  
 Software installation, 1-14  
 Software  
   additional, 4-29  
   compatibility, 4-20  
   defined, 6-1  
   general specifications, 6-5  
   installing non-Morrow, 4-30  
   optional, 6-8  
   reloading onto hard disk, 1-16  
   required, 1-1  
   types, 6-2  
   see also Programs  
 Source diskette (BACKUP), 3-7  
 Spelling checker, see Correct-It  
 Spreadsheet, see SuperCalc  
 STARTUP.PIL file, 4-17  
 Status bits, D-11  
 SUBMIT program, 3-6, 4-24  
 Submit files, 3-6, 3-10  
 SuperCalc  
   exiting from, 2-6  
   function key definitions, B-7  
   running from CP/M, 4-21  
   running through Co-Pilot, 2-6  
   trial run, 2-6  
   User's Guide, 2-6  
 Switch,  
   printer On-Line, 1-19  
   Reset, 2-1  
   terminal setup, 1-9  
 Syntax, 5-2  
 SYS attribute, 2-15  
 SYSGEN program, 3-11  
 SYSLDR.COM file, 3-11, 3-12  
 SYSLDR3.COM file, 3-12  
 System files, 4-7  
 System tracks, 3-12  
 TCS Accounting anomalies, 3-8  
 Telephone line, 6-7  
 Televideo format, 3-9, 4-29, 4-31  
 TERMINAL connector, D-1  
   factory jumper settings, E-4  
   jumper options, E-1  
   modem jumper settings, E-6  
   see also Connectors  
 Terminal  
   adding new, 4-12  
   and SETUP program, D-6  
   can't use 9600 baud, D-8  
   communication specifications, 1-10  
   compatible with Micro Decision, 1-2  
   connecting, 1-6  
   emulation, 1-2  
   function keys, 6-20  
   general requirements, 6-6  
   initializing from .KEY file, B-15  
   keyboard, 6-16  
   levels, 1-14, 3-10, 4-12, 4-30  
   levels, 1-14  
   programming function keys, B-1  
   recommended, 6-6  
   setting up, 1-9  
   software installation, 1-14  
   See also TERMINAL and Connectors  
 Testing Memory message, 1-13  
 TPA, 4-19  
 Transient commands, 4-24  
 Troubleshooting  
   on initial setup, 1-13  
   serial printer, 1-19  
   software installation, 1-16



Turnkey systems, 3-7  
TUTORIAL.PIL file, 4-17  
TYPE command, 2-15  
Typing and printing simultaneously, 4-26  
Unable to Remap error message, 5-6  
Unknown Error Code message, 5-6  
Unpacking, 1-4  
USER command, 2-20, 4-21, 4-24  
User numbers, 4-6, 6-3  
    and file names, 4-2  
    changing current, 2-20, 4-5  
    examining directories, 2-5  
    for application programs, 4-21  
    in CP/M prompt, 4-4  
    programs in user 0, 3-1  
    reason for, 2-4  
Utility Menu, See Co-Pilot  
VERIFILE program, 3-3, 3-13, 3-14, 4-8  
View or Print a File (Utility Menu),  
    2-15, 4-23  
Virtual disk drives, 3-9, 4-3, 6-15  
Write protect notch, 5-5  
Write Protected error message, 5-4  
Write protection, 6-13  
XON/XOFF handshaking, 1-18, D-5  
Z80A CPU, 6-3