

Micro Decision User's Guide

by Dr. Lawrence J. Magid, Ph.D.

Copyright© 1982 by Morrow Designs

All rights reserved.

No part of this publication may be reproduced, transmitted, stored in a retrieval system, or translated into any language or computer language, in any form or by any means, electronic, mechanical, magnetic, optical, chemical, manual or otherwise, without prior written permission of Morrow Designs, Inc.

DISCLAIMER

No representations or warranties, express or implied, are made with respect to the contents hereof, including, but not limited to, the implied warranty of merchantability or fitness for a particular purpose. Further, Morrow Designs, Inc., reserves the right to revise this publication and to make changes from time to time in the content hereof without obligation to notify any person of such revision.

WordStar™ is a product of MicroPro Corporation.

LogiCalc™ is a product of Software Products, Int'l.

BASIC-80™ is a BASIC programming language developed by Microsoft, Inc.

BaZic™ is a NorthStar compatible BASIC language developed by Micro Mike's, Inc.

CP/M 2.2™ and 86™ are operating systems developed by Digital Research, Inc.

Correct-It, Pilot and Micro Menus are products of Morrow Designs.

All references to these products should be so noted.

Foreword

This manual is designed to get you started in your use of the Micro Decision computer. Although it will familiarize you with the supplied software, it is not a substitute for the manuals that accompany the software and the operating system.

We urge you to read the manual completely, performing the simple operations it outlines. Before long, you and your new Micro Decision, (to use a little computer jargon) will be "up and running."

This preliminary version of the manual is subject to revisions. As you use it, please take a few minutes to note the sections that are confusing or particularly helpful. If you send us your comments, we'll return the favor by sending you a free, revised manual.

MICRO DECISION
USER'S GUIDE

Preliminary Edition

Table Of Contents

CHAPTER	PAGE
INTRODUCTION	
Foreword.....	iv
1. INTRODUCTION.....	1
2. ABOUT YOUR SYSTEM.....	7
INSTALLATION	
3. SETTING UP YOUR SYSTEM.....	17
4. TURNING ON YOUR SYSTEM - THE FIRST TIME.....	21
OPERATION	
5. CREATING WORKING SYSTEM DISKETTES	23
6. GETTING STARTED FOREVER AFTER.....	27
7. USING DISKETTES FROM OTHER SYSTEMS.....	33
SPECIAL FEATURES	
8. THE MICRO DECISION VIRTUAL DRIVE.....	35
9. THE AUTO PROGRAM.....	37
10. ERROR MESSAGES.....	41
Conclusion.....	46
APPENDICES	
A. SYSTEM SPECIFICATIONS.....	47
B. TROUBLESHOOTING CHART.....	51
C. THE CP/M COMMANDS.....	53
D. CONNECTING DEVICES TO THE MICRO DECISION.....	57
E. GLOSSARY.....	66
F. RECOMMENDED READING.....	70
INDEX	

List of Figures

1-1: Morrow Designs Terminal and Dual Drive Micro Decision..	1
2-1: Floppy Diskette Features.....	10
2-2: Inserting the Diskette.....	11
2-3: Write Protecting the Diskette.....	12
2-4: Morrow Design Terminal Keyboard.....	13
2-5: Morrow Designs Terminal - Function Keys.....	14
2-6: Morrow Designs Terminal - Numeric Keypad.....	16
2-7: Morrow Designs Terminal - Special Symbol Keys.....	16
3-1: Typical System Set-Up.....	17
3-2: Micro Decision Rear Panel.....	18
3-3: Micro Decision System - Front Panel Orientation.....	19
6-1: THE MICRO DECISION MICRO-MENU Main Menu	27
6-2: CREATE A WORKING OR SYSTEM DISKETTE Menu Option.....	30
D-1: Accessing the Switches and Jumpers.....	59
D-2: Micro Decision Switch and Jumper Locations.....	59
D-3: SW1 - Factory Set Terminal Baud Rate.....	60
D-4: SW2 - Factory Set Printer Baud Rate.....	61

List Of Tables

2-1: Special Keyboard Symbols.....	16
D-1: RS-232 Serial Port Pin Arrangement - Rear View.....	62
D-2: RS-232 Signal Descriptions.....	62
D-3: Micro Decision Serial Port	63
D-4: J1 - Terminal Configuration.....	64
D-5: J2 - Printer Configuration.....	64
D-6: J2 - Modem Configuration.....	64

INTRODUCTION

CHAPTER	SECTION	PAGE
1.	INTRODUCTION.....	1
1.1.	System Hardware.....	2
1.2.	System Software.....	2
1.3.	System Requirements.....	2
	1.3.1. Terminal.....	2
	1.3.2. Diskettes.....	3
1.4.	Optional Hardware Equipment.....	3
	1.4.1. Printer.....	3
	1.4.2. Modem.....	3
	1.4.3. Additional Disk Drives.....	4
1.5.	Optional Software.....	4
1.6.	The Micro-Menus.....	5
2.	ABOUT YOUR SYSTEM.....	7
2.1.	Types of Software.....	7
2.2.	Computer Hardware.....	8
2.3.	Diskettes and Disk Drives.....	9
	2.3.1. Allocation of Disk Space.....	9
	2.3.2. Care of Diskettes.....	10
	2.3.3. Rules for Handling Diskettes.....	10
	2.3.4. Inserting Diskettes.....	11
	2.3.5. Write Protecting Diskettes.....	12
	2.3.6. Backing-Up Your Diskettes.....	12
2.4.	The Terminal Keyboard.....	13
	2.4.1. ESC.....	13
	2.4.2. CAP LOCK.....	13
	2.4.3. SHIFT.....	13
	2.4.4. CTRL.....	14
	2.4.5. BACK SPACE.....	14
	2.4.6. DELETE.....	15
	2.4.7. RETURN.....	15
	2.4.8. NUMERIC KEYPAD.....	15
	2.4.9. SPECIAL SYMBOLS.....	16

CHAPTER 1 INTRODUCTION

The Morrow Designs Micro Decision is an economical computer system, as advanced and sophisticated as those costing several times the price. With the optional Morrow Designs Terminal, and a printer, you have all the hardware and software you need for word processing, proof reading, financial modeling, and programming.

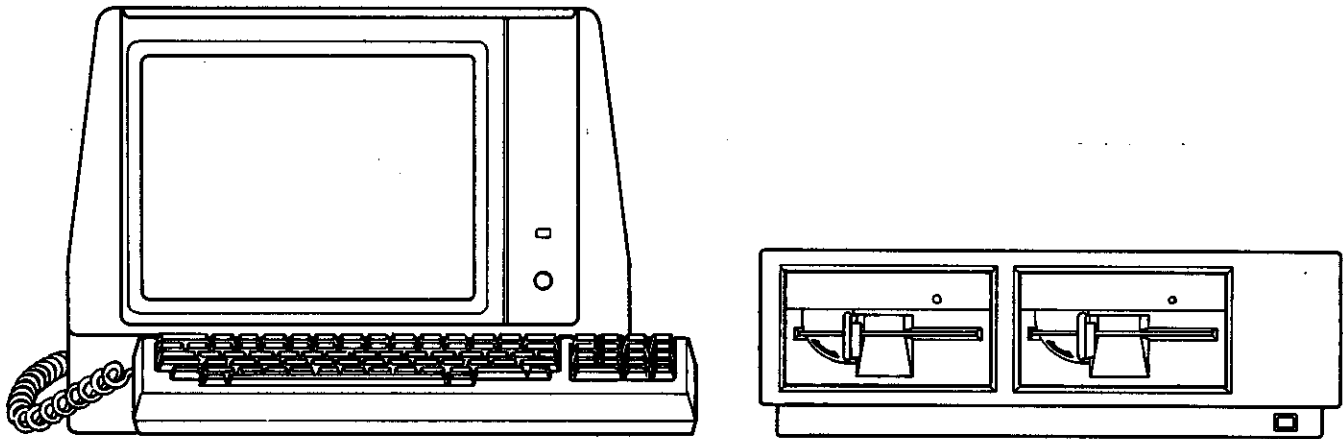

Fig. 1-1: Morrow Designs Terminal and Dual Drive Micro Decision Computer

Because your system comes with the CP/M operating system (Control Program for Microcomputers), you are able to choose from the world's largest library of professionally written business application programs. Your Micro Decision includes the BASIC™, BaZic™ and Morrow Designs' Pilot™ programming languages, Morrow Design's exclusive Micro Menus and many specialized programs for such tasks as diskette copying, program editing, and other "utility functions."

1.1. System Hardware

- 64K bytes of internal Random Access Memory (RAM)
- Z80A (8-bit) Central Processing Unit (CPU)
- 2 RS-232 serial ports (one for your terminal and the other for a printer or modem)
- Floppy disk drive controller for up to 4 drives
- 1 or 2 disk drives

1.2. System Software

- WordStar™ Word Processing System
- Correct-It™ Checks and corrects spelling
- LogiCalc™ Financial modeling and Forecasting program
- CP/M 2.2™ Operating System
- BASIC-80™ Microsoft® BASIC programming language
- BaZic™ NorthStar® compatible BASIC language
- Pilot™ Morrow Designs' programming language designed for learning
- Micro Menus Your road map through CP/M.

1.3. System Requirements

Your Micro Decision comes with all the basics (computer hardware and software) needed to get started, but to complete your system, you will need the following:

1.3.1. Terminal

A computer terminal is required for communicating with your computer. Although the Micro Decision works with most computer terminals, the Morrow Designs Terminal is recommended for those wishing to take full advantage of the software included with the Micro Decision.

1.3.2. Diskettes

The Micro Decision uses single sided, 5 1/4 inch soft sector floppy diskettes, available from most computer and office supply dealers. You need at least seven diskettes to get started. We recommend that you have a box of ten diskettes on hand.

CAUTION: Diskettes are vulnerable to accidental erasure or damage. Before handling diskettes, please refer to Chapter 2 for important information on their care and handling.

1.4. Optional Hardware Equipment

The Micro Decision comes with two RS-232 serial ports. Both are accessed from the back panel of your system unit. One is marked "TERMINAL" and the other "PRINTER/MODEM." These are industry standard interfaces which support a wide variety of printers, modems and other serial communications devices. One RS-232 port **must** be used for your terminal. The other can be used for a printer, a modem, or any other serial device that is compatible with your system. See Appendix D for information on setting up these ports.

1.4.1. Printer

The Micro Decision works with most letter quality and dot matrix printers that can be connected to a serial interface. The printer plugs into the the back panel RS-232 port labelled "PRINTER/MODEM." In some cases the printer serial port may need to be reconfigured. This procedure is described in Appendix D.

1.4.2. Modem

A modem (short for MODulator-DEModulator) connects your Micro Decision to a telephone line, and allows you to exchange programs and data with other microcomputers or with larger computers. You can also access computerized information services such as The Source and CompuServe with a modem.

The modem connects to the RS-232 interface on the back of the system unit labelled "PRINTER/MODEM." Your dealer can provide you with information about modems that can be used with your Micro Decision. Again, see Appendix D for information on connecting these devices. (Note: Connecting your Micro Decision to a modem requires special communication software not supplied with your system.)

1.4.3. Additional Disk Drives

Your Micro Decision comes from the factory with one or two disk drives. Because the CP/M system supplied with the Micro Decision is specially enhanced with a Virtual Drive feature, (see Chapter 8), single drive users have some of the conveniences previously available only to those with two or more drives. All of the software supplied with the Micro Decision work on a single drive system.

Although the Virtual Drive feature makes a single drive system functional, there are good reasons to consider additional drives. Single drive systems can access a maximum of 200K (200,000 characters) of programs and data at any one time. Users with dual drive systems have twice the "on-line" storage space, and are not required to "swap" diskettes when copying files, programs or entire diskettes. See Chapter 2 for a full discussion of disk drives and allocation of diskette space.

Your Micro Decision can accommodate up to four disk drives. Single drive systems can be upgraded by adding another internal drive. Dual drive systems can be upgraded by adding one or two external drives. A four drive system supplies 800k of storage. Contact Morrow Designs or an authorized dealer for information about additional internal or external disk drives.

1.5. Optional Software

The Micro Decision was shipped with several useful and popular application programs. In addition, your Micro Decision is capable of using more than 2,000 additional programs that run using CP/M™. This opens the door for communications programs, data base management systems, games and much more. Some of the CP/M™ users groups distribute free software. See your dealer for information on available software.

You also need to know that there are several CP/M™ diskette formats. By format, we mean the structure of a diskette that the operating system expects before it can read or write information on it.

The Micro Decision uses standard 5 1/4" soft sector diskettes, but for the Micro Decision to read a program or data diskette, the diskette must have a compatible format. In addition to diskettes specially formatted for the Micro Decision, your system can run program diskettes, and read and write data diskettes that have been formatted for the Osborne I® and the Xerox 820® computers.

Additionally, it can read and write to CP/M-86™ data diskettes formatted by an IBM Personal Computer®. Software publishers and distributors are generally able to provide CP/M™ programs in the format required by the customer. If your dealer or any software publishers are not able to help you, have them contact our customer service department.

1.6. The Micro Menus

The CP/M™ operating system has many powerful commands. Although they can be learned with a little practice, they tend to be somewhat intimidating for the novice user. To make your Micro Decision easier to use, we have implemented the Micro Menus - a series of "menus" which allow you to enter CP/M™ and program commands. Using the menus reduces many complex commands to a single keystroke - a feature that even experienced computer users will appreciate.

All of the commands executed from your Micro Menus can also be executed directly from CP/M™. If you study the screen as you use the menus, you will see what the operating system is actually doing. It is as if you have a CP/M™ expert standing over your shoulder pressing the keys as you watch.

CHAPTER 2 ABOUT YOUR SYSTEM

There are two essential elements to any computer system - hardware and software. If you think of your computer as a stereo system, your hardware is like the turntable, amplifier, radio and tape deck. The software is like your music collection, whether it is on records, tapes, or even FM radio signals. Music brings out the value and power of a fine stereo system. Software brings out the value and power of your Micro Decision.

2.1. Types of Software

There are several types of software including operating systems, languages, programs, and data.

The operating system is the interpreter which allows the hardware to "talk to" and "listen to" the software. It is an essential element to any system. Your Micro Decision comes with the CP/M™ operating system. It was selected not only because it is powerful and versatile, but because it supports a large number of business and personal software packages.

A language is the set of rules and terms that a programmer uses to write application programs. The language, working through the operating system, tells the machine what the programmer wants it to do. There are many languages compatible with the Micro Decision computer, ranging from the highly complex, like machine language to the simple, like Pilot™. Languages can be stored on diskettes and loaded into the computer just like other software.

A program is a set of instructions that makes your system do what you want it to do. If you want to use your Micro Decision as a word processor, you must use word processing software such as WordStar™. Additional programs may be purchased, and you can write some yourself using one of the languages provided with your Micro Decision.

Data is the information being processed. If you use WordStar™ to create your great novel, the actual words of the novel are your data.

As an illustration, let's trace a letter created with WordStar™. The letter is data that was created by the WordStar™ program. WordStar™ is written in assembly language and runs under the CP/M™ operating system.

Files: Your data is stored on the diskette in files. Think, for a moment, of a diskette as drawers in a filing cabinet. It can contain lots of different

files. You can place any information in the drawers of the cabinet, but only certain information goes into each file. Your letter to Ms. Smith, for example, would be in the drawer used for correspondence. If you were using WordStar™ to create that letter, you could file it on a special diskette for correspondence with a file on that diskette called "SMITH." Your letter to Mr. Jones could be on the same diskette, but it would be in a different file, perhaps called "JONES."

You might have another drawer for your financial records, just as you might have a diskette for the files you create with LogiCalc™. Your "income tax" information might be in one file and your accounts payable records in another.

Programs are also stored in files, though they differ from data files. The operating system can tell the difference between a program file and a data file. Program files are executed (run) and data files are read, written to, or otherwise manipulated by programs.

2.2. Computer Hardware

The hardware on your Micro Decision consists of a cabinet, a power supply, a central processing unit, memory chips, a disk drive controller, one or two disk drives, and an assortment of chips, resistors, plugs, and wires.

The "brains" behind the system is the Z80A central processing unit (CPU). That sounds (and is) impressive, but it's actually only one chip, about 3/8 inches square.

Another essential element is the Random Access Memory (RAM). Your system is equipped with 64k of memory. Each "k" (short for kilobyte) consists of 1024 bytes or characters. This translates to 65,536 bytes - each byte being the equivalent of one single number or letter.

The Random Access Memory determines how much information your computer can manipulate at any one time. Information stored in RAM can be instantaneously accessed by the computer. RAM acts as a temporary

storage area, but any information in RAM disappears when a new program is run, when the computer is turned off, or when the electric company decides to interrupt your power. Fortunately, you have another more permanent means to store information - diskettes. These are also known as floppy diskettes, disks, discs or, affectionately, "floppies." We call them "diskettes."

2.3. Diskettes and Disk Drives

Information (data and programs) is transferred between the floppy diskettes and the RAM (Random Access Memory) via the disk controller and disk drives. Disk drives are a little like tape recorders - they read and write magnetically encoded information on the diskettes. The diskette itself is the plastic substance which is sealed in a protective black cardboard shield. Diskettes are similar in substance and function to magnetic tape. The disk drive can add information to a diskette (so long as there is room) or it can record new information over old, erasing the information that was there before.

2.3.1. Allocation of Disk Space

The floppy diskettes that work with your Micro Decision can store up to 200k or 204,800 bytes (characters) of information. About 14k on each diskette is reserved for the CP/M™ operating system, leaving about 186k for programs or data. Therefore, the amount of data that can be accessed by the computer at any one time is 186k times the number of drives. Users with two drives are able to access up to 372k of programs and data without swapping diskettes.

Unlike most CP/M™ systems, the Micro Decision's Virtual Drive feature makes it possible for single drive users to have their programs and data on separate diskettes. This means it is possible to create and access larger data files with a single drive Micro Decision system than is possible with other single drive systems. Whenever another diskette is needed, the enhanced operating system tells the user to change diskettes. Chapter 8 explains this feature in more detail.

2.3.2. Care of Diskettes

Diskettes are very important to your system. Information written on a diskette is "permanent" until you erase it or write over it - just like magnetic tape. Unfortunately, there are other ways to remove information from diskettes, like placing them near magnets, exposing them to extreme heat or touching their magnetic surfaces with your fingers.

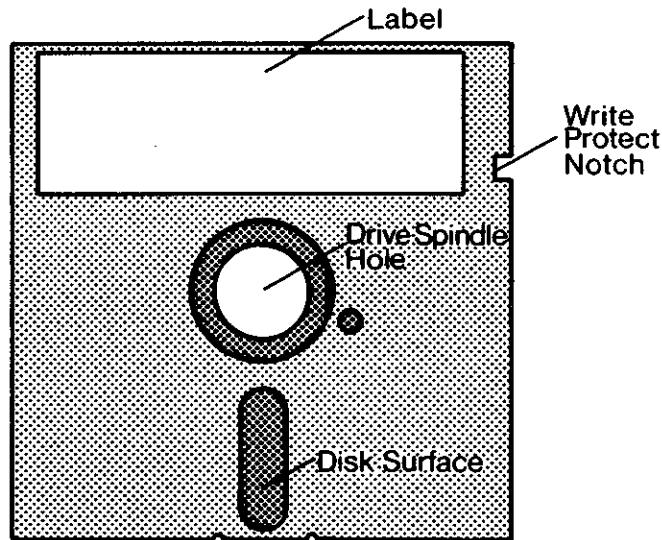

Fig. 2-1: Floppy Diskette Features

2.3.3. Rules for Handling Diskettes

1. Never touch the plastic recording surfaces of the diskette. Handle them only by the protective cardboard shield.
2. Always store diskettes in the envelopes provided.
3. Never write on an affixed diskette label in pencil or ball point pen. If you must write on a label after it is affixed, do so lightly with a felt tip pen.
4. Keep diskettes away from extreme heat, humidity, dust, or magnetic fields. Telephones, stereo speakers and color T.V. sets can create magnetic fields.
5. Do not lay heavy objects on diskettes. Keep from bending if stored vertically.

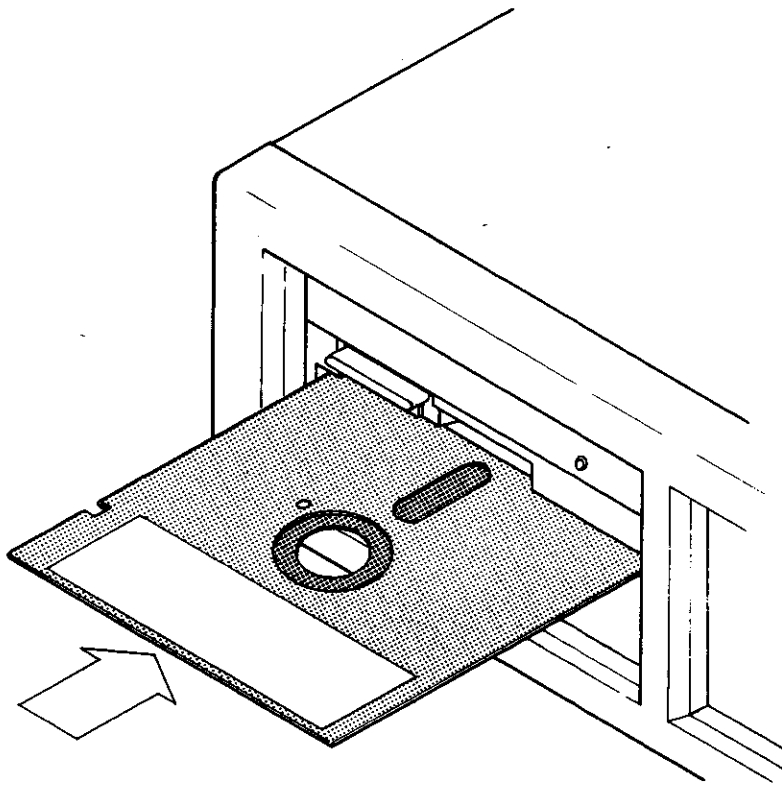

Fig. 2-2: Inserting the Diskette

2.3.4. Inserting Diskettes

The drive on the left side of the Micro Decision is called drive A. If you have two drives, the one on the right is referred to as drive B. If you have external drives, they are referred to as drives C, and D.

Drive A is the start up drive. The diskette with your programs are placed in drive A. Drive B is usually used for data diskettes. The following is the proper procedure for inserting diskettes:

1. Open door of the disk drive. This is done by turning the latch on the front of the drive up and towards the left.
2. Touching only the cardboard shield, insert the diskette all the way into the drive with the label facing up and the notch (if any) to the left. The exposed oblong shaped area is inserted first. Think of that oblong as an arrow, pointing the direction in which the diskette is inserted.
3. Close the disk drive door.

2.3.5. Write Protecting Diskettes

Most diskettes have a write protect notch, on their right side. With the notch exposed it is possible to write to, or erase the information on the diskette.

Covering that notch with a write protect tab (a label, or piece of tape) prevents you from accidentally erasing material on a diskette. It is a good idea to write protect your back up copies of the diskettes that contain valuable data or programs. Write protect tabs are usually included with the diskettes you purchase.

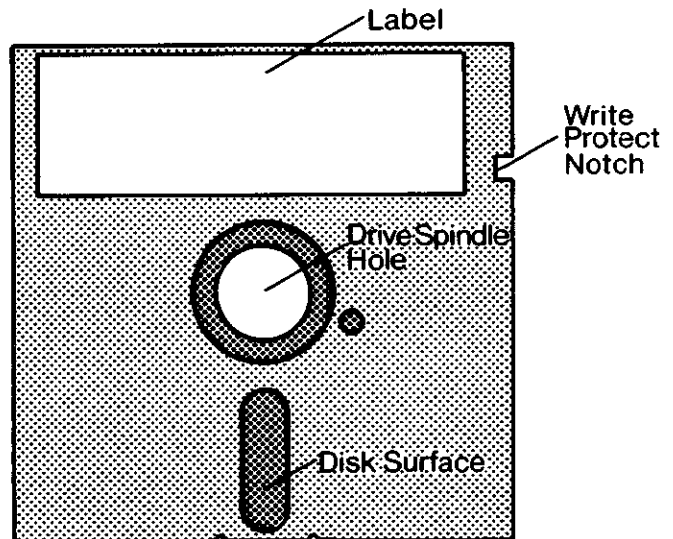

Fig. 2-3: Write Protecting the Diskette

Some program distribution diskettes do not have a write protect notch. They were shipped without the notch to discourage users from accidentally erasing or damaging them. In most cases, these programs can (and should) be copied to another diskette which is not write protected.

2.3.6. Backing-Up Your Diskettes

Even if you follow our suggestions, there is still a chance that a diskette can be accidentally damaged or lost. Therefore, it is very important that you "back-up" (duplicate) the diskettes that contain your important programs and data. Backing up a diskette is easy and cheap insurance against a potential catastrophe. Back-up procedures are discussed in Chapter 6.

2.4. The Terminal Keyboard

The keyboard on the Morrow Designs Terminal (and most other terminals) is similar in many respects to a standard typewriter keyboard. However, there are additional keys that are used to send special instructions to the computer. How the keys work depends on the software. Nevertheless, there are some keys that are commonly used by many programs and these are described below.



Fig. 2-4: Morrow Design Terminal Keyboard

2.4.1. ESC

The use of the ESC (short for ESCAPE) key depends on the application program. In WordStar™, for example, you are asked to "Press ESC" after executing certain commands or if the software detects certain errors. ESC is used in the Micro Decision Micro Menu programs to return to (or "escape to") the Main Menu.

2.4.2. CAP LOCK

The CAP LOCK is like the shift lock key on a typewriter. It causes all letters typed to be in upper case. It has no affect on the number keys.

2.4.3. SHIFT

The SHIFT key works like the shift key on a standard typewriter. To type an upper case letter (or a symbol above the a number key), hold down the SHIFT key and type the letter.

2.4.4. CTRL

The CTRL key (short for CONTROL) is always used in conjunction with another key to send a special command to your computer. Your keyboard has 26 letter keys (A through Z). The CTRL key can be used with these to add an additional 26 "keys" to your system. It can also be used with the numbers and some of the symbols. The CTRL key is used just like the shift key. When you are asked to enter CTRL A, you hold down the CTRL key and press the A key. The CTRL key is sometimes referred to by the ^ symbol. If a manual or help menu tells you to press ^A, it is the same as CTRL A.

You will find the CTRL key especially important when you begin using WordStar™. To delete a word, for example, the WordStar™ manual instructs you to type ^T. In this case, you hold down the CTRL key and, without releasing it, press T. Although this may sound cumbersome, it is very easy to get used to.

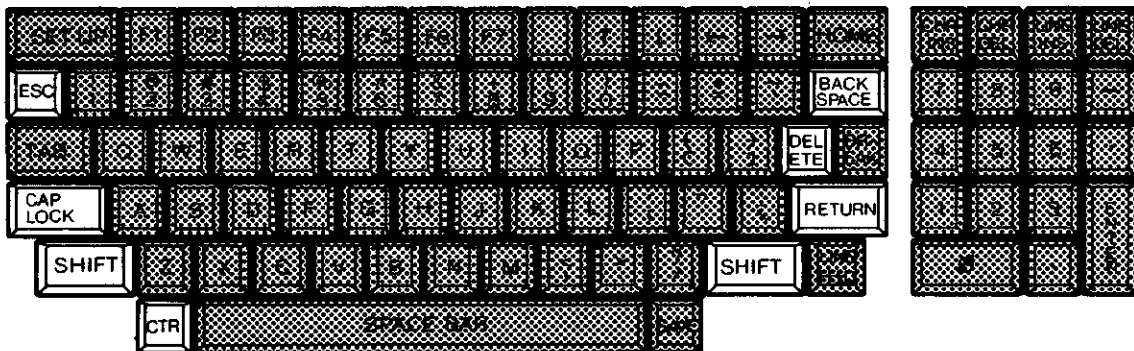

Fig. 2-5: Morrow Designs Terminal - Function Keys

2.4.5. BACK SPACE

The BACK SPACE key and the DELETE key work in very much the same way, in that they both erase characters. Both these function depend on the program you are running at the time, however. In WordStar™, for example, pressing the BACK SPACE key will back the cursor over the characters, but will not erase them. Under CP/M™, however, BACK SPACE is the recommended key to use to erase characters.

INSTALLATION

CHAPTER	SECTION	PAGE
3.	SETTING UP YOUR SYSTEM.....	17
	3.1. Unpacking the System.....	17
	3.2. Where to Place Your New System.....	17
	3.3. Cables and Plugs.....	18
	3.4. System Unit Power Switch.....	19
	3.5. System Unit RESET Button.....	19
	3.6. Terminal Power Switch.....	20
	3.7. Terminal Brightness Control.....	20
4.	TURNING ON YOUR SYSTEM - THE FIRST TIME.....	21
	4.1. Diagnostic Test.....	21
	4.2. Instructions For Turning on the Micro Decision.....	21

2.4.6. DELETE

The DELETE key is used in most application programs to back over and erase characters, but if entered under CP/M™, will "echo out" or retype the characters entered before erasing them. DELETE is also used at times to stop program execution. If all this seems confusing now, note that most programs include descriptions of how these keys are used, and it won't be long before you are familiar with them.

2.4.7. RETURN

The RETURN key (called the ENTER key on some terminals) is somewhat like a carriage return on a typewriter, but has additional uses. When doing word processing, for example, it is used to end a paragraph. In most cases, the RETURN key must be pressed to execute your command. Many programs do not recognize commands until the RETURN key is pressed. That's why it is sometimes called the "ENTER" key. It is used to enter commands.

2.4.8. NUMERIC KEYPAD

The Morrow Designs terminal has a numeric keypad which is similar to an adding machine or calculator keypad. This pad is handy when using programs that require a substantial amount of numeric entries. The keys on the numeric keypad can be used interchangeably with the number keys above the letters on the keyboard.

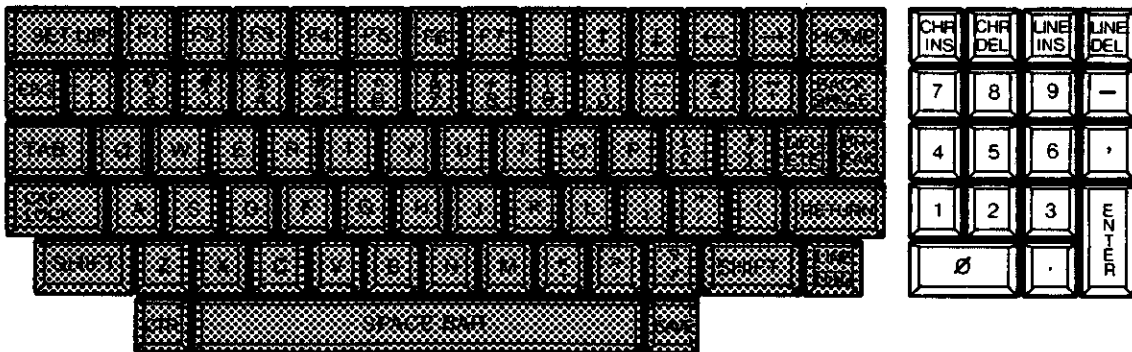

Fig. 2-6: Morrow Designs Terminal - Numeric Keyboard

2.4.9. SPECIAL SYMBOLS

There are several special symbols on your Morrow Designs terminal (and most other terminals) that do not appear on standard typewriters, and there are common symbols which serve double duty on a computer. These symbols are used in languages and programs for arithmetic functions. These are covered in the manuals that accompany BASIC™, LogiCalc™ and other languages and programs that use such symbols. Although their use can vary, here are some common symbols and their definitions.

Table 2-1: Special Keyboard Symbols

SYMBOL	RESULT
<	Less than
>	Greater than
+	Addition
-	Subtraction
*	Multiplication
/	Division
=	Equals

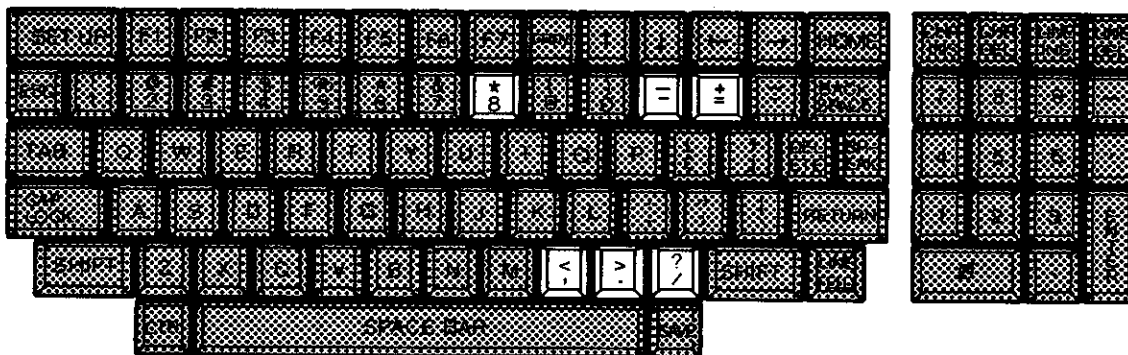

Fig. 2-7: Morrow Designs Terminal - Special Symbol Keys

CHAPTER 3 SETTING UP YOUR SYSTEM

The instructions in this section will help you set up your new computer.

3.1. Unpacking the System

Follow the unpacking instructions in the box and check the system carefully for damage. If there is any damage, report it to your dealer immediately.

3.2. Where to Place Your New System

Your Micro Decision can be placed on any desk or table, but there are some considerations that will make your use of the computer more comfortable and help you avoid potential eye and back strain.

Most desk and table tops are about 31 inches from the floor. This is usually too high, placing unnecessary strain on your arms and back. Although the "ideal" keyboard height depends on the person, the chair, and other considerations, a rule of thumb is to place the keyboard so that the "home" row of keys (the row with ASDF) is about 28 inches from the floor. It is also wise to place the display screen in a position that avoids reflected glare and to avoid sitting with your back to a window or a strong light.

The keyboard on the Morrow Designs Terminal detaches from the display screen, allowing you to place it in any comfortable position.

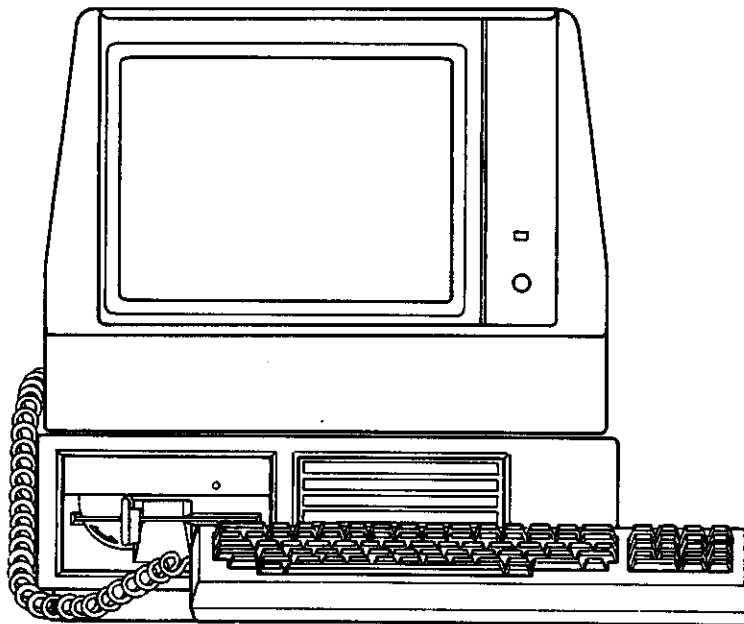

Fig. 3-1: Typical System Set-Up

3.3. Cables and Plugs

The following cabling instructions apply to the Morrow Designs and most other terminals. For more information, see the manual that accompanies your terminal.

Be sure that the power to both the terminal and Micro Decision computer is off. Looking at the Micro Decision system unit from the rear, notice the connectors. The plug furthest to the right is the RS-232 port designated for your terminal. The plug immediately to its left is another RS-232 serial port that allows you to plug in a printer, modem, or other serial device. The plug furthest to the left is used only if you are connecting external disk drives.

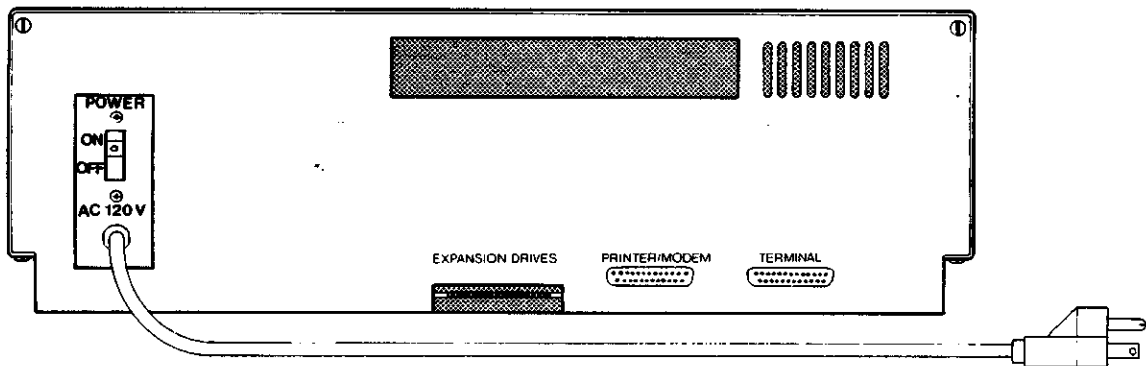

Fig. 3-2: Micro Decision Rear Panel

The Micro Decision and the terminal are connected via a cable with identical RS-232 plugs at each end. Plug one end of the cable into the Micro Decision system terminal connector and the other end into the terminal. Many terminals, including Morrow Designs', have two connectors. On the Morrow Designs terminal, use the connector on the left labelled RS-232C. Other terminals may be labelled MODEM, EIA, or RS-232. It doesn't matter which end of the cable goes into which unit, but there is only one way you can insert the plugs. If you encounter resistance, the plug is probably upside down.

CAUTION: Plug both the terminal and Micro Decision power cords into a grounded wall outlet. The use of a 2 hole outlet and an ungrounded "cheater plug" is not recommended.

3.4. System Unit Power Switch

The power switch, located on the rear panel, must be on when the system is in use.

CAUTION: If the switch is turned off while a program is running (or if power is otherwise interrupted), any data in the computer's memory is erased.

The power switch does not affect data that has already been transferred to a diskette.

3.5. System Unit RESET Button

The illuminated RESET button, located at the lower right corner of the front panel, is used to "boot" or start up your system. It is also used to re-load the operating system. See the next chapter for a brief and simple explanation about "booting" your system.

CAUTION: Pressing RESET while a program is running terminates the program and erases any data in memory.

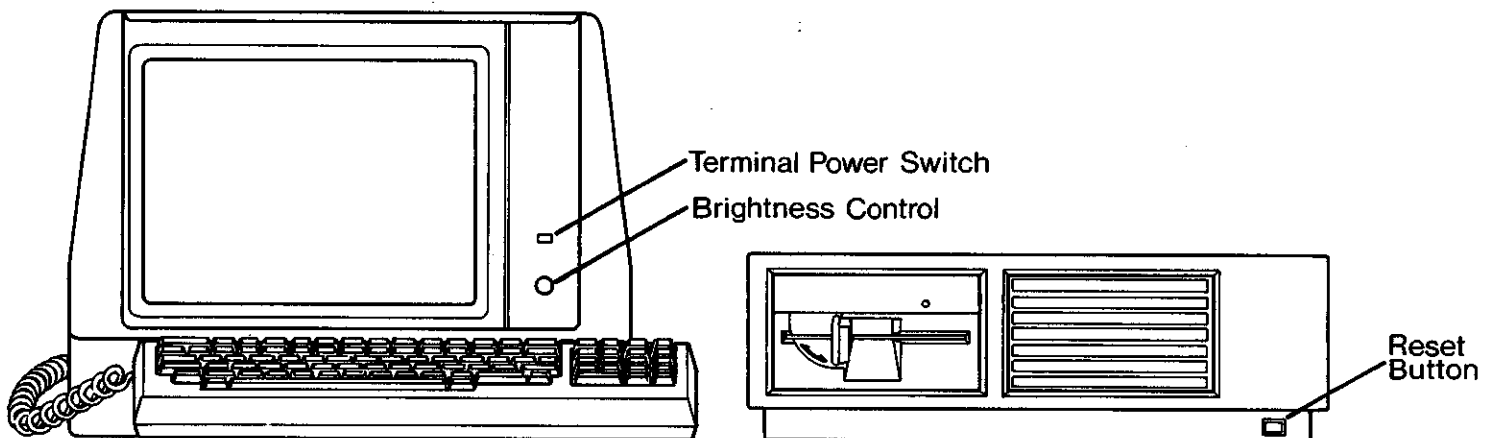

Fig. 3-3: Micro Decision System - Front Panel Orientation

Although not likely with any of the software provided by Morrow Designs, it is possible to encounter a program that "locks up", "crashes" or otherwise fails to perform. In these cases, you need to terminate the program. Generally, programs have a prescribed method for termination, but if that fails you can always resort to pressing the RESET button. Pressing this button terminates the program and removes the program and any data from the computer's memory. It does not affect data that has already been transferred to a diskette.

3.6. Terminal Power Switch

Your terminal has a separate power switch. The power switch on the Morrow Designs Terminal is the small black button located on the front, above the round brightness nob.

3.7. Terminal Brightness Control

The Morrow Designs Terminal has a brightness nob on the front panel. To increase brightness, turn the nob clockwise.

BEFORE YOU TURN THE PAGE:

1. Make sure the terminal and computer are plugged into grounded outlets.
2. Make sure the RS-232 cable is plugged into the "TERMINAL" plug on the system unit and the appropriate plug on the terminal.

You are now ready to turn on your system.

CHAPTER 4 TURNING ON YOUR SYSTEM - THE FIRST TIME

This chapter describes how to turn on and test your computer.

4.1. Diagnostic Test

The Micro Decision performs a diagnostic test each time the power is turned on. It is performed with or without a diskette in the drives.

4.2. Instructions For Turning on the Micro Decision

1. Turn on the terminal and wait until it warms up. The Morrow Designs Terminal is ready when a beep is heard, and a green rectangle appears in the upper left corner of the screen. If nothing appears on the screen after a few seconds, try turning the brightness knob clockwise.
2. Turn on the Micro Decision. Your terminal should immediately beep and display a message. If it does not beep, turn off both the Micro Decision and the terminal and check that your cables are properly connected. If everything is properly connected, the following message appears on your screen after a few seconds:

```
MORROW DESIGNS MICRO DECISION Rev 1.n  
Testing Memory — Please Stand By
```

NOTE: That flashing rectangle in the upper left corner of your screen is called the cursor. It marks the spot where whatever character you type appears on the screen. If you press a number, letter, or symbol key, the cursor moves to the right and the character you press takes its place.

About 15 seconds later, the following should appear after the first message:

```
MORROW DESIGNS MICRO DECISION Rev 1.n  
Testing Memory -- Please Stand By: Memory O.K.  
  
INSERT SYSTEM DISKETTE IN DRIVE A AND PRESS [RETURN]
```

If there are any other messages, refer to Appendix B.

You are now ready to make a working copy of your CP/M™ System Diskette.

OPERATION

CHAPTER	SECTION	PAGE
5.	CREATING WORKING SYSTEM DISKETTES	23
5.1.	Instructions For Creating SYSTEM DISKETTES	23
5.2.	Configuring the SYSTEM DISKETTE for Your Terminal...	24
6.	GETTING STARTED FOREVER AFTER.....	27
6.1.	"Booting" the Micro Decision	27
6.2.	The Micro Decision Menu.....	28
6.2.1.	CREATE A WORKING OR SYSTEM DISKETTE.....	28
6.2.2.	RUN A PROGRAM.....	28
6.2.3.	DISPLAY A DISKETTE DIRECTORY (DIR).....	28
6.2.4.	VIEW OR PRINT A FILE (TYPE, PIP).....	28
6.2.5.	COPY A FILE (PIP).....	28
6.2.6.	FORMAT A DISKETTE (FORMAT).....	29
6.2.7.	MAKE A BACKUP DISKETTE (FORMAT, BACKUP).....	29
6.2.8.	CHECK DISKETTE AND FILE SIZE (STAT).....	29
6.2.9.	OTHER OPTIONS (REN, ERA, STAT).....	29
6.2.10.	EXECUTE A CP/M COMMAND.....	29
6.2.11.	EXIT TO CP/M (ESC).....	30
6.2.12.	Re-entering the Menu Program.....	30
6.3.	Creating a Working or System Diskette.....	30
6.3.1.	Creating a Wordstar System Diskette.....	30
6.3.2.	Creating Other Working Program Diskettes.....	31
7.	USING DISKETTES FROM OTHER SYSTEMS.....	33
7.1.	Compatible Systems.....	33
7.2.	Copying To or From a Foreign Diskette.....	33
7.3.	Teaching Your Drive to Emulate a Foreign Drive.....	34

CHAPTER 5 CREATING WORKING SYSTEM DISKETTES

The software that comes with your Micro Decision is supplied on special distribution diskettes. These diskettes cannot be used to run programs. The information on them must be copied on to working diskettes before any programs can be run. This is to protect you against damaging your distribution diskettes and losing the valuable programs. Once the information has been copied, the distribution diskettes can be put in a safe place, to be used only if you need additional copies of the application programs.

The Micro Decision Distribution Diskettes contain the CP/M™ operating system, the Micro Menu, the application programs included with your system and many other useful programs.

Distribution Diskette #1 was designed to copy its programs onto what we call the "SYSTEM DISKETTE." It does this automatically if you follow these simple steps.

Note to Single Drive Users:

Because of our Virtual Drive feature (see Chapter 8), the system knows how many drives you have, and when it sees a reference to drive B, or any non-existent drive, it knows it should really go to drive A. When the system instructs you to insert a diskette in drive B, you can insert it in drive A (your only drive) and the enhanced operating system knows what to do. Copying diskettes with a single drive system requires you to occasionally remove a diskette and replace it with another diskette. This is called "swapping" diskettes. Typically, users with single drive systems swap diskettes about four times for every file copied.

5.1. Instructions For Creating SYSTEM DISKETTES

1. Check to see that your computer and terminal are on.
2. Place Micro Decision Distribution Diskette #1 in drive A. Start the system by pressing the RESET button.
3. Almost immediately, disk drive A starts to whir and the red indicator light turns from dim to bright. Don't be alarmed by what may seem to be strange sounds coming from the disk drive. Your disk drive is now reading some of the information on the diskette in drive A and transferring that information into your computer.

4. Follow the instructions on your screen: The Micro Decision automatically formats and creates a working SYSTEM DISKETTE on the blank diskette in drive B:

```
Software Distribution Diskette #1
For copying only

Place a blank diskette in Drive B: (A for single drive
systems) and press RETURN.
```

The Micro Decision tells you when the copy is complete. At that time, remove your newly created diskette, label it as SYSTEM DISKETTE, and place your Micro Decision Distribution Diskette #1 in a safe place. You may never need to use the distribution diskette again, but it is important to have it as a back-up.

The diskette you just created is your working SYSTEM DISKETTE. It contains several useful programs including one that you'll use to copy your other diskettes. When we refer to the SYSTEM DISKETTE, we are referring to the diskette you just created.

You are now ready to configure your newly created SYSTEM DISKETTE for your terminal.

5.2. Configuring the SYSTEM DISKETTE for Your Terminal

The Micro Decision was designed to work with several computer terminals, including the Morrow Design Terminal. Terminals have different means of displaying characters. As a result, it is necessary to configure your newly created SYSTEM DISKETTE for your particular terminal. This is done only once and takes just a few seconds.

1. Place the newly created SYSTEM DISKETTE in Drive A and "boot" the system by pressing RESET. This causes disk drive A to whirl and loads information from the SYSTEM DISKETTE into the computer.
2. A Terminal Selection menu appears on the screen. Select your terminal by pressing the appropriate number. If your terminal is not listed, ask your dealer which option most closely resembles your terminal (you may have a terminal which "emulates" one that is on the list).

3. The disk drive whirs for a few seconds while your SYSTEM DISKETTE is configured for your terminal.

Any diskettes that are formatted from the newly configured SYSTEM DISKETTE (or any copies of the SYSTEM DISKETTE) automatically have the correct terminal configuration on them. As a result, you will not have to configure this or any other diskette again unless you change terminals.

You now have a fully configured working SYSTEM DISKETTE. From now on, each time you load your SYSTEM DISKETTE, you go right to the Micro-Menu, unless you later configure the diskette so that it doesn't take you into the menu (see Chapter 9 regarding the AUTO command).

Notes

CHAPTER 6 GETTING STARTED FOREVER AFTER

The instructions in the previous sections described how to set up your Micro Decision and get it started. This section describes the operation of your computer once you are all set up and ready to go.

6.1. "Booting" the Micro Decision

If your computer and terminal are on, turn them off so you can practice loading ("booting") the system from a power off "cold start."

1. Turn on your terminal.
2. Turn on your Micro Decision computer. The system will run its Diagnostic test.
3. Place the SYSTEM DISKETTE in drive A. Boot the system by pressing the RETURN key.
4. After a few seconds, the Micro Menu appears on your screen.

THE MICRO DECISION MICRO MENU

This menu is your road map through the CP/M operating system. To perform these functions, just enter the appropriate number after the **OPTION** prompt below, then follow the instructions given.

```
0   CREATE A WORKING OR SYSTEM DISKETTE
1   RUN A PROGRAM
2   DISPLAY A DISKETTE DIRECTORY (DIR)
3   VIEW OR PRINT A FILE (TYPE, PIP)
4   COPY A FILE (PIP)
5   FORMAT A DISKETTE (FORMAT)
6   MAKE A BACKUP DISKETTE (FORMAT, BACKUP)
7   CHECK DISKETTE AND FILE SIZE (STAT)
8   OTHER OPTIONS (REN, ERA, STAT)
9   EXECUTE A CP/M COMMAND
ESC  EXIT TO CP/M
```

OPTION:

Fig. 6-1: THE MICRO DECISION MICRO MENU - Main Menu

From now on, this menu appears automatically whenever you load your SYSTEM DISKETTE.

6.2. The Micro Decision Menus

The Main Menu lists options that are most commonly used under CP/M™. Most computers require you to learn the CP/M™ commands to perform these functions. However, the Micro Menus supplied with the Micro Decision perform the functions for you, just as you would type them from the keyboard. Notice the words in parenthesis to the right of most of the options. These are standard CP/M™ commands. You can learn about them by reading the CP/M™ manual included with your system, or you can sit back and watch the menus perform the commands for you. Here is a discussion on each of the menu options. See the CP/M™ manual if you wish to learn more about how these functions work.

6.2.1. CREATE A WORKING OR SYSTEM DISKETTE

We made this one first because we want to encourage you to do this right away. This option helps you make working copies of the programs included with your system.

6.2.2. RUN A PROGRAM

This option runs a program. The menus lead you directly to the program you wish to run. You are returned to the menu at the end of the program.

6.2.3. DISPLAY A DISKETTE DIRECTORY (DIR)

This option performs the CP/M™ directory command "DIR." It gives you a list of all files on a diskette in whichever drive you specify.

6.2.4. VIEW OR PRINT A FILE (TYPE, PIP)

This option is recommended when you want to take a quick look at the contents of a data file. The contents of the file move continuously up your screen. This is known as "scrolling." You can pause the scrolling by pressing CTRL S (press any other key to resume scrolling). To cancel scrolling, press CTRL C.

6.2.5. COPY A FILE (PIP)

This option performs the CP/M™ "PIP" (Peripheral Interchange Program) command. PIP has many functions. The one invoked by this menu option copies a file from one diskette to another. It can be used to copy program or data files or the contents of an entire diskette to another diskette. Just follow the instructions on the screen.

6.2.6. FORMAT A DISKETTE (FORMAT)

Before you can write anything on a diskette, the diskette must be formatted by the CP/M™ operating system. This process writes special codes to the diskette that CP/M™ needs to read or write to the diskette.

If you wish to create a diskette for data (WordStar™ or LogiCalc™ files, for example), it must be formatted before you can write to it. This is done from this menu choice.

CAUTION: When you FORMAT a diskette, you erase any information that is on that diskette

6.2.7. MAKE A BACKUP DISKETTE (FORMAT, BACKUP)

This option invokes two CP/M™ programs. It formats (FORMAT) a destination diskette and copies the entire source diskette to the destination diskette (BACKUP).

This procedure should be used to make back-up copies of your important data and program diskettes.

6.2.8. CHECK DISKETTE AND FILE SIZE (STAT)

This options performs the CP/M™ "STAT" command. STAT can check the size of each of your files, and the remaining available diskette space. You should perform this command when you are about to enter WordStar™ or any other program that creates diskette files. STAT has additional features which are described in the CP/M™ manual and appear in the OTHER OPTIONS menu choice.

6.2.9. OTHER OPTIONS (REN, ERA, STAT)

This takes you to another menu which lists all the other options that can be executed through the menus.

6.2.10. EXECUTE A CP/M COMMAND

This menu choice is helpful for learning the CP/M™ commands. It asks you to type in the CP/M™ command you wish to execute, and if entered correctly, executes it for you, then returns you to the main menu. Its a "foolproof" way to learn CP/M™.

6.2.11. EXIT TO CP/M (ESC)

You can leave the menu program at any time by pressing ESC. This takes you directly into CP/M™.

6.2.12. Re-entering the Menu Program

To re-enter the menu program type

PILOT CPMENU

after the CP/M™ prompt (A>) and press RETURN.

6.3. Creating a Working or System Diskette

This menu allows you to make working copies of all of your application programs, guiding you through the procedure one step at a time. The Micro Menus copy programs from your distribution diskettes to your working diskettes. They do this by automatically implementing the CP/M™ PIP commands.

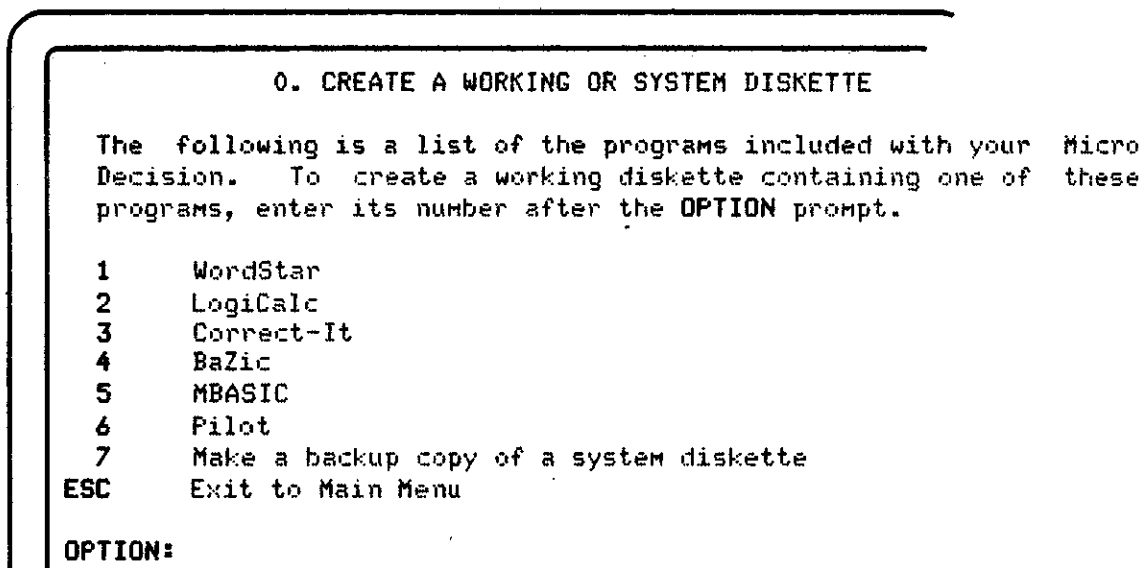

Fig. 6-2: CREATE A WORKING OR SYSTEM DISKETTE Menu Option

Note to Single Drive Users: See single drive instructions in Chapter 5 and Virtual Drive discussion in Chapter 8.

6.3.1. Creating a Wordstar System Diskette

Begin by making a working WordStar™ diskette by following the instructions on the screen. The WordStar™ program is included on one of your distribution diskettes.

Any time you are asked to INSERT a diskette, you must, of course, first remove any diskette that is currently in that drive. The SYSTEM DISKETTE does not necessarily have to be in the disk drive once the copy program starts.

Once you have copied the WordStar™ program, you are asked to re-insert the SYSTEM DISKETTE and are returned to the Working Program Creation Menu.

6.3.2. Creating Other Working Program Diskettes

The procedure described for WordStar™ applies to all your programs. Just press the key that corresponds to the program and insert the appropriate distribution diskette when asked to do so. Go through the menu, one program at a time, until you have made working application diskettes for all the programs on the menu. You should also make a back up copy of your SYSTEM DISKETTE.

NOTE: After you have made your working diskettes from your distribution diskettes, place the distribution diskettes in a safe place. You probably won't need them again, but it's important to have them as back-ups.

When you are finished making working copies of all your programs, exit to the Main Menu by pressing ESC.

Notes

CHAPTER 7 USING DISKETTES FROM OTHER SYSTEMS

As we explained in a previous chapter, programs that run under the CP/M™ operating system do not necessarily come on diskettes that can be read by all CP/M™ systems. That is because different CP/M™ systems use different methods for formatting diskettes. There are some standards among systems using 8" diskettes, but no standards for the increasingly popular 5 1/4" diskettes.

7.1. Compatible Systems

To help overcome the lack of standards, the Micro Decision is equipped to emulate the diskette formats used by the Osborne I® (single density), Xerox 820® (5 1/4" single sided), and the IBM Personal Computer® (CP/M-86™, single sided). We refer to these compatible diskettes from other computers as "foreign diskettes."

You can read and write data files and run most programs written for the Xerox 820® and the Osborne I®. Because the Osborne I® uses a non-standard screen format (52 columns instead of 80), some Osborne programs are incompatible.

The Micro Decision can read and write CP/M-86™ data files created by an IBM PC, but it can't run CP/M-86® software. Because the IBM PC uses a 16-bit microprocessor, it is incompatible with the Micro Decisions' Z80A central processing unit. The Micro Decision cannot read or write to IBM's PC-DOS diskettes.

There are two ways that you can use foreign diskettes. You can re-define one or more of your diskette drives to emulate the foreign format, or you can copy the information on the foreign diskette to a diskette formatted for the Micro Decision. Once the files have been copied to a diskette formatted by the Micro Decision you can forget they were once "foreign" and treat them like all your other Micro Decision files.

7.2. Copying To or From a Foreign Diskette

Use the 4. COPY A FILE menu choice provided on your SYSTEM DISKETTE to copy the files from a foreign diskette to a Micro Decision diskette. When you select the option called "COPY USING A FOREIGN DISKETTE" you are taken to another menu that allows you to copy FROM or TO a foreign diskette. The FROM option allows you to copy data or programs from a foreign diskette format, and the TO option allows you to transfer your files to a diskette format different from the Micro Decision.

7.3. Teaching Your Drive to Emulate a Foreign Drive

You can temporarily re-define any of your disk drives (including your Virtual Drive) to become a "foreign" drive. This is done using the emulation programs (OSB.COM, XER.COM or IBM.COM) that are on your SYSTEM DISKETTE. The procedure is simple, but your SYSTEM DISKETTE (or another diskette containing these programs) must be in drive A.

To emulate an Osborne® drive, type OSB followed by the drive name. To define drive B: to read Osborne I® diskettes, for example, enter

OSB B:

after the CP/M prompt and press RETURN.

To emulate a Xerox 820® system, type XER followed by the drive name

XER A:

To emulate an IBM CP/M-86™ drive, type IBM followed by the drive name (i.e. IBM C:)

If you select a non-existent drive, the system invokes the Virtual Drive and temporarily re-defines drive A to be that drive. While drive A is the Virtual Drive, it emulates the foreign system. When drive A is acting as the physical drive, it functions normally (see extended discussion on Virtual Drives in Chapter 8).

It is not possible to format diskettes on the Micro Decision for an Osborne, Xerox or IBM computer. These programs only allow you to read or write diskettes already formatted for these systems.

To return your drives for use with diskettes formatted for the Micro Decision, reboot the system by pressing the RESET button.

CHAPTER 8 THE MICRO DECISION VIRTUAL DRIVE

No matter how many disk drives you have, there are times when it is handy to have one more. With the Micro Decision's Virtual Drive feature, you "virtually" have that extra drive. That's because the system is able to re-assign drive A to double as another drive while still serving as drive A.

8.1. Example of the Virtual Drive Feature

Here's a simple example of how the Virtual Drive system works. We're going to check the available space on the diskette in drive E. Of course, drive E doesn't really exist. Or does it?

1. Insert your SYSTEM DISKETTE into drive A. This diskette contains STAT.COM, the CP/M command used to check available diskette space.
2. Type Stat E:
3. The system displays:

Your left hand drive is being reassigned as drive E.
Exchange diskettes and press RETURN

Insert the appropriate diskette in physical drive A (now re-assigned as drive E). When you swap the diskettes, STAT tells you available diskette space, just as if drive E were a physical drive.

8.2. Example Using WordStar

Although the Virtual Drive feature is especially handy for single drive systems, it can be helpful no matter how many disk drives you have.

Let's say you are running WordStar on a two drive system and find that you have run out of diskette space when you try to save a file that you are editing. Since WordStar doesn't permit you to swap diskettes while editing, you'd be out of luck with most CP/M systems. But with the Virtual Drive you can write that file to a non-existent drive, swap the diskette that is currently in drive A, and save the day. Here's how it's done:

1. Get into a WordStar file and enter some text. Pretend there is no room to store the text on the diskette(s) in your disk drive(s).
2. Go to the beginning of the file by entering the WordStar ^QR command. Insert a block begin marker (^KB).

3. Go to the end of the file (^QC) and insert a block end marker (^KK).
4. Type WordStar's command* to write the block to another file (^KW). When WordStar asks you "NAME OF FILE TO WRITE MARKED TEXT ON?" type C:TEMP. .

Since you don't really have a C drive, the Virtual Drive feature temporarily re-assigns drive A to be drive C. As soon as the system sees a reference to a drive that doesn't exist, it informs you with:

Your left hand drive is being reassigned as drive C.
Exchange diskettes and press RETURN.

Now WordStar continues to operate as if you had a three drive system. Of course, you don't really have three drives, so you'll have to swap diskettes in drive A a few times while drive A is temporarily re-assigned as drive C, then back as drive A. When drive A is re-assigned as drive C, insert the diskette that would be in drive C (if you had a drive C). When drive A is re-assigned as drive A, re-insert the WordStar program diskette that normally goes in drive A.

* These WordStar commands are described in the WordStar manual, included with your system.

SPECIAL FEATURES

CHAPTER	SECTION	PAGE
8.	THE MICRO DECISION VIRTUAL DRIVE.....	35
	8.1. Example of the Virtual Drive Feature.....	35
	8.2. Example Using WordStar.....	35
9.	THE AUTO PROGRAM.....	37
	9.1. Creating an AUTO Diskette.....	37
	9.2. Automatically Running a Program.....	38
	9.3. Changing or Cancelling the AUTO Command.....	38
10.	ERROR MESSAGES.....	41
	10.1. Backing Up - An Ounce of Prevention.....	41
	10.2. Error Message Categories.....	41
	10.3. Booting Errors.....	42
	10.3.1. Boot Error.....	42
	10.3.2. No System.....	42
	10.4. Recoverable Errors.....	42
	10.4.1. Drive Not Ready.....	42
	10.4.2. Write Protected.....	42
	10.4.3. Not Found.....	43
	10.4.4. Data Error.....	43
	10.4.5. Lost Data.....	43
	10.5. Non-Recoverable Errors.....	43
	10.5.1. Select Error.....	44
	10.5.2. Diskette Read Only.....	44
	10.5.3. File Read Only.....	44
	10.6. When an Error Message Is Displayed.....	44
	10.6.1. R	44
	10.6.2. A.....	45
	10.6.3. I.....	45

CHAPTER 9 THE AUTO PROGRAM

You probably noticed that some of the diskettes provided with the Micro Decision automatically execute programs when they are booted. This was done by using the AUTO.COM program that is supplied with your Micro Decision. This chapter shows how you can create, change, or cancel the programs or commands that are automatically executed.

It is possible for you to configure any of your diskettes so that they automatically execute a built-in command or program (programs with a .COM at the end of their name) each time they are booted. This is known as creating a "turnkey" system. Such a system is ready to run at the "turn of a key" (or by just inserting a diskette into the drive slot.)

You can create your own "turnkey" diskettes by using the AUTO.COM program. This program can be used to configure a diskette that already has programs on it, or it can be used with a newly formatted, but otherwise blank, diskette.

You need a diskette with the AUTO.COM program on it in order to configure a diskette, but AUTO.COM does not have to be transferred to the diskette being configured.

9.1. Creating an AUTO Diskette

Let's say you want to create a diskette which gives you a directory listing every time it is booted. Normally to get a directory of the diskette in the active drive, you would type DIR (RETURN) from the keyboard. By making DIR your AUTO command, it is done for you automatically when you boot-up.

1. Insert the diskette that contains the file AUTO.COM in drive A, type:

AUTO DIR A: (DO NOT PRESS RETURN)

2. Remove that diskette and replace it with the diskette that you wish to configure to automatically execute DIR.
3. Press RETURN.

That's all there is to it. Each time you boot that diskette you are automatically be treated to a directory of its files.

NOTE: When using AUTO with built-in commands, it is necessary to specify both the drive and the command.

You could also have the system automatically display a simple message each time the diskette is inserted into the drive. Here's how:

1. Use WordStar™ to create a file called "MESSAGE."
2. Insert the diskette containing AUTO.COM and type
AUTO TYPE A: MESSAGE (DO NOT press RETURN).
3. Remove that diskette, replace it with the diskette that contains the file called "MESSAGE", and press RETURN.

Now, when someone boots that diskette, the MESSAGE file is automatically displayed on the screen.

9.2. Automatically Running a Program

You can also configure a diskette to automatically run a program. Unlike the CP/M™ built-in commands, it is not necessary to specify a drive when using AUTO to run these programs.

EXAMPLE:

To determine available diskette space, you have to run the program "STAT.COM." Normally you do this by typing STAT (RETURN) from the keyboard (STAT.COM must be on your diskette). Here's how to create a diskette that automatically runs STAT.COM when booted.

1. Insert the diskette that contains the file AUTO.COM in drive A and type:

AUTO STAT (DO NOT PRESS RETURN)
2. Remove that diskette and replace it with the diskette that you wish to configure to automatically execute STAT.
3. Press RETURN.

9.3. Changing or Cancelling the AUTO Command

It is possible to change or cancel an AUTO command.

To change an AUTO command: Go through the same process used to create the AUTO command, using the new command instead of the old one.

1. Insert the diskette that contains the file AUTO.COM in drive A and type:

AUTO NEW COMMAND (DO NOT PRESS RETURN)

2. Remove that diskette and replace it with the diskette that you wish to re-configure.
3. Press RETURN.

To cancel an AUTO command: Go through the same steps, but do not enter a new command.

1. Insert the diskette with AUTO.COM in drive A.
2. Type AUTO (DO NOT PRESS RETURN)
3. Remove that diskette and replace it with the diskette containing the AUTO command that you wish to cancel.
4. Press RETURN.

Notes

CHAPTER 10 ERROR MESSAGES

We all make mistakes. Computer hardware, in fact, rarely breaks down. But moving parts can wear out and electronic parts can, on rare occasions, fail to perform. Although there is a great deal of excellent commercially available software, most users eventually happen upon a program with "bugs." Most errors, however, can be traced to humans. The solution isn't to place blame, but to quickly identify the source of an error and get it resolved.

The unmodified version of CP/M™ issues special messages when it encounters software, hardware or operator errors. However, the messages tend to be difficult to understand and the errors difficult to rectify. Some errors can cause programs to fail and data to be lost.

The operating systems supplied with your Micro Decision has an enhanced version of CP/M™ with a special error detection feature that informs you of an error in plain English and, in many cases, "traps" the error so that you can correct it before it causes any serious problems.

10.1. Backing Up - An Ounce of Prevention

There are no guarantees against errors, but there is a way to reduce the possibility of a catastrophic consequence by always backing up copies of your important program and data diskettes. Then, if something goes wrong, you at least have a copy of your work to fall back on.

10.2. Error Message Categories

We have divided the errors into three categories:

The first group of errors can occur while you are booting (loading the CP/M™ operating system into the computer). There is no need to recover from these errors since they occur prior to running a program or entering data. If such an error occurs, correct the problem and re-boot.

The second group are potentially recoverable errors that can occur while the system is running. If such an error occurs, you might be able to recover your program or data.

The third group cannot be recovered from. If you encounter these errors, you must re-boot the system.

10.3. Booting Errors

Since these errors only occur while you are loading, or "booting" your system, there is no need for a recovery procedure. If an error occurs, rectify the problem and re-boot. A description of these errors follows:

10.3.1. Boot Error

This error could be caused by a faulty SYSTEM DISKETTE, trying to load the system from a drive other than A:, inserting the system diskette into the drive incorrectly, or leaving the drive door open.

10.3.2. No System

The diskette you booted did not have the CP/M™ operating system on it. The CP/M™ operating system must be on the diskette in drive A:.

If you encounter such an error, you must correct the problem and re-boot. Your options are to:

1. Copy the operating system to the non-system diskette (use the Micro Menus or see the CP/M™ manual for information about SYSGEN).
2. Copy the information from that diskette to one which already has the CP/M™ system (use the Micro Menus or see the CP/M™ manual for information about PIP).

10.4. Recoverable Errors

These errors can occur when you are trying to read or write to a diskette. If you encounter one of these errors, rectify the problem and follow the procedures described in section 10.6. Error messages displayed are described below:

10.4.1. Drive Not Ready

The disk drive is not ready. This can be caused by a number of things including no diskette in the drive, drive door open, or a problem with the drive, cable or disk controller. Rectify the problem and try again. If you cannot get the system to work, consult your dealer or service department.

10.4.2. Write Protected

You have attempted to write to a diskette that is write protected. That means that the write protect notch is covered. If you want to write to that disk, you must

remove the write protect tab and try again.

Some diskettes do not have a notch and are therefore permanently write protected. These are generally software distribution diskettes that were protected by the manufacturer to avoid accidental erasure or damage. In most situations, the files on these diskettes can, and should, be copied to one of your own diskettes.

10.4.3. Not Found

The disk controller is unable to locate information on the diskette. This can be caused by trying to access a diskette that is either damaged, unformatted, or formatted for a computer other than the Micro Decision. If you are sure that your diskette is properly formatted, it may have been damaged. Sometimes it is possible to read or write to a damaged diskette by making several attempts. If you suspect that the diskette has been damaged, try to copy the information to a freshly formatted diskette.

10.4.4. Data Error

Whenever information is written on a diskette, additional error control codes are also written. When the information is read back, these codes allow the disk controller to determine if the information has been read correctly. This error is usually caused by a damaged or incorrectly formatted diskette or by a hardware failure in the drive or controller. Whether or not you recover from the error, try copying the contents of this diskette to a new, freshly formatted diskette.

10.4.5. Lost Data

Data is transferred to and from the diskette at a precise rate. Your Micro Decision must be synchronized to this rate. This error can occur if your Micro Decision is not synchronized correctly, or by a problem with the diskette. Sometimes you can recover from this error by trying again. It is possible that the diskette is slightly damaged. Try copying the contents of this diskette to a freshly formatted diskette.

10.5. Non-Recoverable Errors

If any of these errors occur, the system is generally re-booted automatically, but it may be necessary to abort the disk operation by entering an A after the prompt, which also re-boots the system. (Also see Section 10.6.) These type of errors are described on the next page.

10.5.1. Select Error

An invalid drive was selected (only drives A: through E: are valid drive addresses).

10.5.2. Diskette Read Only

You attempted to write to a diskette that is configured as "read only."

The STAT command can be used to configure diskettes or files as "read only." This is one way to protect you from accidentally erasing or writing to a diskette. It is possible to reconfigure the diskette using STAT. This is different than a "File read only" error message (see below).

10.5.3. File Read Only

You attempted to write to a file configured as "read only." This is similar to the above message but it applies to a particular file rather than the entire diskette.

10.6. When an Error Message Is Displayed

After displaying the error message, the enhanced CP/M™ operating system waits for a response from you (unless the system is automatically re-booted). All responses except entering an R, A, I at the keyboard are ignored. These keys produce the following results:

10.6.1. R

Tries action again. This is obviously helpful if the error was due to an open drive door or something else that you have corrected. It sometimes solves the problem with "Not found" or "Lost data" errors. Sometimes, too, the disk drive can read the data if you try again.

EXAMPLE:

Disk error on drive B: Drive not ready.
Type R to try again, A to abort, or I to ignore:

Correct the problem (close the door, insert diskette, etc.), then enter

R (Do not press RETURN)

APPENDICES

CHAPTER	SECTION	PAGE
A.	SYSTEM SPECIFICATIONS.....	47
B.	TROUBLESHOOTING CHART.....	51
C.	THE CP/M COMMANDS.....	53
C.1.	CP/M Built-In Commands.....	53
C.1.1.	CTRL C.....	53
C.1.2.	TYPE.....	53
C.1.3.	CTRL S.....	54
C.1.4.	CTRL P.....	54
C.1.5.	DIR.....	54
C.1.6.	REN.....	54
C.1.7.	ERA.....	55
D.	CONNECTING DEVICES TO THE MICRO DECISION.....	57
D.1.	Serial Communication.....	57
D.2.	Hardware Settings for the Micro Decision.....	58
D.3.	Accessing the Switches and Jumpers.....	58
D.4.	Micro Decision Baud Rate Settings.....	60
D.4.1.	Terminal Baud Rates.....	60
D.4.2.	Printer or Modem Baud Rates.....	61
D.5.	Configuring the RS-232 Serial Ports.....	62
D.5.1.	Jumpers J1 and J2.....	62
D.5.2.	J2 - Modem Configuration.....	64
D.5.3.	About the Serial Ports.....	65
D.5.4.	CP/M Device Definitions.....	65
E.	GLOSSARY.....	66
F.	RECOMMENDED READING.....	70
	INDEX	

10.6.2. A

Abort disk operation. This causes a system "warm boot," re-loading your CP/M™ system.

EXAMPLE:

Disk error on drive B: Not found.

Type R to try again, A to abort, or I to ignore:

enter

A (Do not press RETURN)

10.6.3. I

Ignore the error message. This should be used with extreme caution, especially when writing data to a diskette. Using this command can lull you into a false sense of security since disk operations appear to proceed as normal despite the possibility of a faulty diskette.

Conclusion

We wish we could end this manual with some self-congratulatory message such as "You now know all there is to learn about the Micro Decision." That would be like learning to drive a boat and claiming you know everything about the seven seas and the lands they connect. The Micro Decision, like a boat, is only a vessel. Where it takes you and how you use it depends more on the bounds of your curiosity and imagination than on the limits of the hardware and supplied software. Learning to use a computer is a never ending process. Just when you feel you have mastered something, another challenge awaits you.

This little manual was written to get you started. It was not designed to be inclusive. Fortunately, others have continued where we left off. There are a number of books, magazines, users groups, retailers and others dedicated to helping you learn more about computers. We have included references to some guides about CP/M™ and computers in general, but this too is limited.

For further assistance, and a native guide for your journey through the land of computers, we strongly recommend your local Morrow Designs' dealer.

A. SYSTEM SPECIFICATIONS

MICRO DECISION

ENCLOSURE:

Dimensions: 16.9" wide x 11.3" long x 5.3" high
(43 cm wide x 29 cm long x 13.5 cm high)

Net Weight: 18 lbs. (8.1 kgs.)

Composition: RFI (Radio Frequency Inhibiting) metal

POWER:

External: 115 VAC (+/- 10%), 50/60 Hz (domestic)
230 VAC (+/- 10%), 50/60 Hz (export)

Internal: +5VDC +/-5% 1.90 Amps
+12VDC +/-5% 1.20 Amps
-12VDC +/-5% 0.03 Amps

TEMPERATURES:

Operating: 50° F to 104° F
(10° C to 40° C)

Non-operating: -40° F to 125° F
(-40° C to 52° C)

PROCESSOR:

CPU: Z80A, operating speed: 4MHz

MEMORY:

RAM: 64K bytes
EPROM: 2K bytes

DISK DRIVES:

Internal: 1 or 2 5 1/4" floppy diskette drives standard

External: 2 additional 5 1/4 inch drives may be connected.

Diskettes: Standard 5 1/4" soft-sectored,
1024 bytes/sector, 5 soft sectors/track,
40 tracks/side, 1 side/diskette

Capacity: 200K bytes per diskette (formatted)

INPUT/OUTPUT:

Serial I/O: 2 RS-232C serial ports
Baud Rate: Asynchronous: 75 - 19.2 Kilobaud

MORROW DESIGN TERMINAL

DESCRIPTION:

Dimensions: Monitor: 12.2" high x 14.6" deep x 16.5" wide
(31 cm high x 42 cm deep x 37 cm wide)
Keyboard: 2.75" high x 7.5" deep x 16.5" wide
(7 cm high x 19 cm deep x 42 cm wide)
Weight: Monitor: 21.2 lbs. (9 kgs.)
Keyboard: 3 lbs. (1.5 kgs.)

POWER:

Domestic: 115V/60Hz
Export: 230V/50Hz (optional)

Video Display Screen:

Description: TTY compatible, microprocessor-based video display screen.
Presentation: 12 inch monitor with P31 non-glare green phosphor
24 lines x 80 characters per line
Dual intensity, reverse video, underline and blinking attributes
Characters: 128 character ASCII code set - 96 displayable characters and 32 non-displayable control characters
Format: 7x11 dot matrix within 9x12 field
Signals: Bell tone; audible key-click
Cursor: Block or underline, steady or blinking - keyboard selected and controlled.
Modes: Normal and monitor - user selectable

KEYBOARD:

Layout: Standard typewriter-style keyboard attached to terminal by 6 foot coil cord

Keys: 92 keys including separate 14-character adding machine style keypad with ENTER key, 8 cursor control keys, 4 editing keys and 7 programmable function keys

TERMINAL COMMUNICATION:

Transmission: Serial asynchronous (character-by-character)

Speed: 75-19,200 baud rate - keyboard selectable

Protocol: 7 or 8 data bits - keyboard selectable
1 or 2 stop bits - keyboard selectable
Even, odd or no parity - keyboard selectable

Mode: Full or half duplex - keyboard selectable

Interface: 1 EIA RS-232C (20mA current loop) for terminal connection

1 auxiliary EIA RS-232C serial output interface with independent baud rate selection for terminal, printer or MODEM connection

OTHER FEATURES:

Repeat Rate: Auto repeat at 15cps - all keys

Graphics: Auxiliary graphic character set

Line Feed: Auto LF/CR - keyboard selectable

Diagnostics: Built-in self-test function

B. TROUBLESHOOTING CHART

The following table has been designed to aid you in the event your Micro Decision does not operate correctly:

PROBLEM	PROBABLE CAUSE	REMEDY
SYSTEM MEMORY TEST FAILS:		Contact your dealer.
RESET INDICATOR LIGHT NOT LIT:	Power cord not plugged in.	Plug in cord.
	Wall outlet not live.	Check outlet and circuit breaker.
	Indicator light burned out.	Contact dealer
	Internal connection loose.	Contact dealer.
DISK DRIVE INDICATOR LIGHT DOES NOT BLINK	System was not reset.	Press RESET.
	Indicator light burned out.	Contact dealer.
	Internal connection loose.	Contact dealer.
DRIVE TRIES TO LOAD, SEEK, BUT TERMINAL SCREEN IS BLANK:	Floppy diskette inserted incorrectly.	Insert SYSTEM DISKETTE with label facing up and away from slot.
	Incorrect diskette inserted.	Insert SYSTEM DISKETTE.
	Cables and plugs incorrectly connected.	Refer to Section 3.3.
	Terminal is off.	Turn it on.

PROBLEM	PROBABLE CAUSE	REMEDY
SYSTEM LOADS WITH GARBLED MESSAGE:	Terminal not con- figured correctly.	Refer to Sec- tion 5.2.
	Baud rate or word setting incorrect.	Refer to Appen- dix D.
	SYSTEM DISKETTE is ruined.	Make or use another SYSTEM DISKETTE.

C. THE CP/M COMMANDS

The Micro Menu program can perform many CP/M™ commands for you, but it's also a good idea to understand something about the CP/M™ commands. As you progress in using and learning about your Micro Decision, you may find situations where it is better not to use the Micro Menu. The menus and the Pilot™ language needed to run them take up diskette space that can be used for other files.

This discussion is not a substitute for the CP/M™ manual. This chapter is deliberately more simple and machine specific than the discussion in the CP/M® 2.2 Manual included with your system. You are encouraged to read this manual as well as some of those listed in Appendix F.

C.1. CP/M Built-In Commands

The following commands are built into the CP/M™ operating system. Executing them does not require the presence of any particular program or file.

C.1.1. CTRL C

Generally used to abort a command or perform a "warm boot" of the system. If you press CTRL C while your computer is under the control of the CP/M™ operating system, CP/M™ interrupts what it is doing and re-loads the operating system. If you press CTRL C while running most BASIC™ programs, the program stops and you are returned to BASIC™, with the program remaining in memory. (CTRL C does not return you to CP/M™, however. That is done from BASIC™ by typing SYSTEM).

C.1.2. TYPE

Displays the contents of a file. Enter TYPE followed by file name, press RETURN and the contents are scrolled on your screen. If you precede a TYPE command with a CTRL P, the contents of the file is also routed to the printer.

Example of TYPE:

Your WordStar™ application diskette has a file called "EXAMPLE.TXT." WordStar™, of course, has its own system for displaying (and printing) files. But if you wanted to display that file from the CP/M™ operating system, you would enter:

```
TYPE EXAMPLE.TXT (RETURN)
```

C.1.3. CTRL S

Used by the operating system to pause while you are scrolling text (using the TYPE command) or are listing a program. Press CTRL S to pause, and any other key to resume scrolling.

C.1.4. CTRL P

Routes information to the printer as well as the screen. After you press CTRL P, anything that appears on the screen is also sent to the printer. This remains in affect until you press CTRL P again or perform a "warm boot" by pressing CTRL C.

C.1.5. DIR

Displays a list of all files on your diskette. Type DIR followed by a carriage return. For a printed copy of your directory, proceed DIR with a CTRL P.

Examples of DIR:

To get a catalog (list) of all files on the currently logged drive:

DIR (RETURN)

To get a catalog of all files on Drive B, if drive A is the currently logged drive:

DIR B: (RETURN)

C.1.6. REN

Allows user to RENAME a file on the diskette. It is assumed that the file to be renamed is on the currently logged drive.

Example of REN:

To change the name of a file, enter the new name desired followed by the current name in the following way

REN NEWNAME = OLDNAME

The new file name goes to the left of the equal sign and the old one goes to the right of it.

C.1.7. ERA

Allows you to erase files on your diskette. This is a non-reversible command.

CAUTION: Once erased, files cannot be restored unless they are backed-up on another diskette.

Examples of ERA:

To erase a file called "FILE1" on the currently logged drive:

ERA FILE1

To erase a file on drive B: if drive A: is the currently logged drive:

ERA B: FILE1

D. CONNECTING DEVICES TO THE MICRO DECISION

Terminals, printers and modems are plugged into the rear panel of the Micro Decision with cables that have a 25-pin connector attached at each end. One end goes into the back panel of the terminal or printer, the other to the back panel of the computer. These connections allow data to be sent to and received from the computer. This action is also referred to as input/output (I/O). Terminals, printers, modems and similar equipment are referred to as I/O devices.

D.1. Serial Communication

Although the actual connection of I/O devices to a computer is fairly straightforward, getting the devices to communicate with each other isn't always so easy since these devices often "talk" at different speeds and sometimes even in a different language. Fortunately, the engineers who developed these devices have also developed ways to get all the components of a computer system to communicate with each other.

The two 25-pin plugs at the rear of the Micro Decision are referred to as RS-232C serial ports. The specification for these ports was developed by the Electronic Industries Association (EIA) and has become a standard means of connecting, or interfacing, devices such as terminals and modems to a computer. By making certain adjustments, you can set up what is called a communication protocol that will control the speed and flow of data transmission to and from the computer.

There are several ways that data may be transferred in a computer. Since the Micro Decision is set up with serial ports, the way that it handles data transfers is called serial communication, meaning that data is sent out one bit at a time. In the microcomputer world, one character is made up of 8 bits. Data is transmitted sequentially, one bit at a time until 8 bits are grouped together, forming one byte or character. Each group is preceded by a start bit and ended with two stop bits. The start bit tells the receiving unit that a character is being sent; the stop bits tell it that the transmission is finished, that the character has been sent.

The speed at which data is transmitted between a printer or terminal and the computer is called the baud rate. One baud equals one bit per second. For example, most terminals now run at 9600 baud, or at 9600 bits per second (about 960 characters per second).

**NOTE: PROCEDURES DESCRIBED IN THIS SECTION SHOULD BE
DONE BY QUALIFIED TECHNICAL PERSONNEL**

Switches and jumpers on your computers' printed circuit board are adjusted to change the communication protocol for the devices you are connecting to it.

Normally, this won't be necessary since your computer is shipped from the factory set to go for most terminals and printers that are on the market today. If you have an old terminal, an odd brand printer or wish to use a modem, however, these hardware settings may have to be changed.

D.2. Hardware Settings for the Micro Decision

The hardware in the Micro Decision is factory set for the following:

Protocol: 1 start bit, 8 data bits, 2 stop bits, no parity

Terminal: 9600 baud rate, no handshaking

Printer: 1200 baud rate, standard CTS handshaking

If you connect the Morrow Design (or compatible) terminal and most any serial printer currently on the market to the Micro Decision, you will be in business. If you want to connect an I/O device that is not compatible with these settings, you must get inside the Micro Decision and change some hardware settings.

D.3. Accessing the Switches and Jumpers

Before you begin, **TURN OFF POWER TO YOUR SYSTEM and UNPLUG THE POWER CORD.** Six screws must be removed before taking off the cover: The screws in both the upper right and left corner of the back panel, two underneath the front and two underneath the rear cover that connect the cover to the chassis. If you are changing jumper settings for the printer port, it will also be necessary to undo the four screws on the back panel that hold the cord pan in place. Changing the printer's baud rate does not require removal of the cord pan.

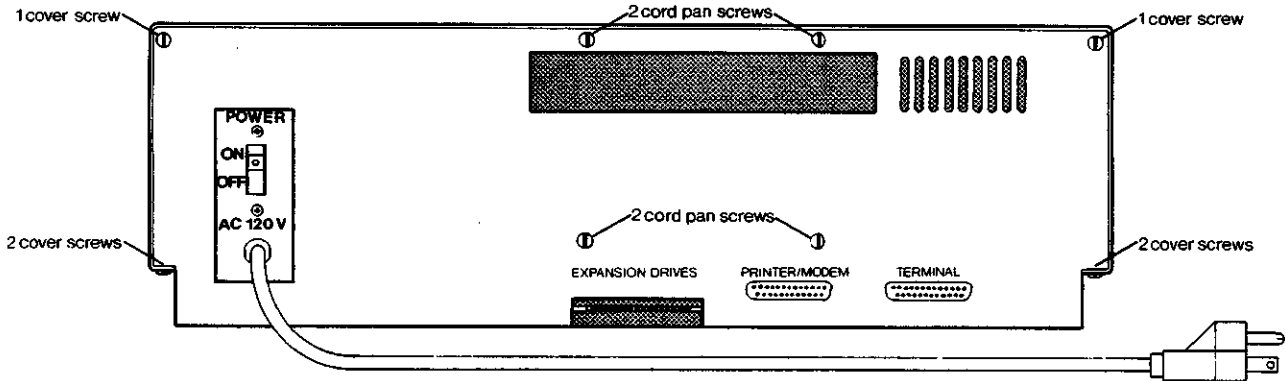

Fig. D-1: Accessing the Switches and Jumpers

Carefully slide the cover off towards the front. The jumpers and switches we are concerned with here are located in the top left corner of the board, if you are looking from the front of the machine. They may also be located by finding board locations A through D along the left side of the board. The following figure illustrates this area.

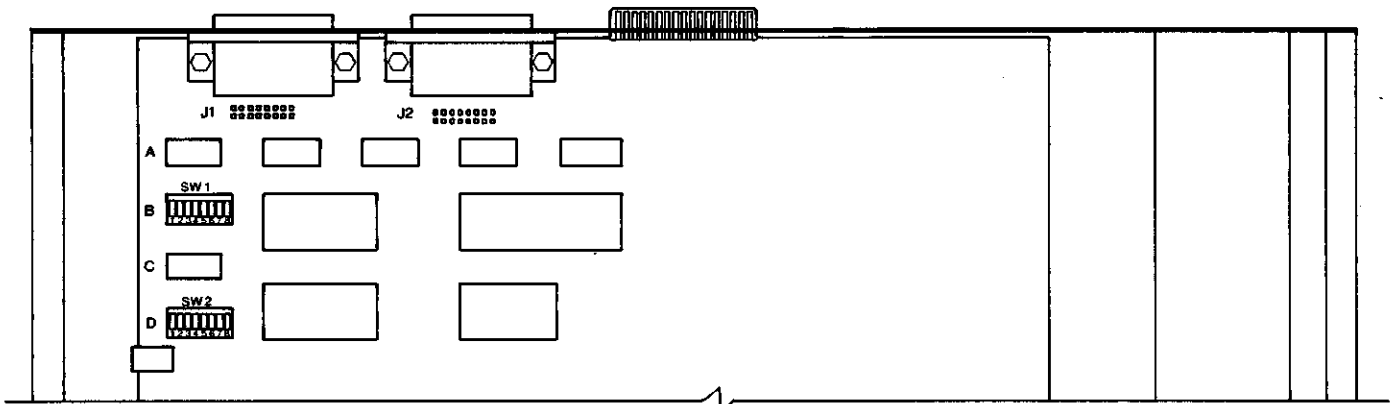

Fig. D-2: Micro Decision Switch and Jumper Locations

D.4. Micro Decision Baud Rate Settings

The baud rates are set with switches SW1 and SW2 (at board locations B1 and D1). All paddles on these switches are OFF except for the paddle that corresponds to the baud rate you wish to select.

D.4.1. Terminal Baud Rates

Switch SW 1 controls the baud rate for a terminal connected to the Micro Decision (the right 25-pin plug as viewed from the back) and is factory set for 9600 baud, as shown in the figure below:

Fig. D-3: SW1 - Factory Set Terminal Baud Rate

ON		
1	0==	19200
2	==0	9600
3	0==	4800
4	0==	2400
5	0==	1200
6	0==	600
7	0==	300
8	0==	150

To change this setting, (to accommodate a terminal that runs at 19,200 baud, for example), turn paddle 2 to the OFF position, then turn the paddle that corresponds to the desired baud rate to the ON position:

SW 1		
ON		
1	==0	19200
2	0==	9600
3	0==	4800
4	0==	2400
5	0==	1200
6	0==	600
7	0==	300
8	0==	150

D.4.2. Printer or Modem Baud Rates

Switch SW 2 controls the baud rate for a printer or modem plugged into the left 25-pin serial port (rear view) on the Micro Decision back panel and is factory set for 1200 baud, as shown in the following figure:

Fig. D-4: SW2 - Factory Set Printer Baud Rate

ON

1	0==	19200
2	0==	9600
3	0==	4800
4	0==	2400
5	==0	1200
6	0==	600
7	0==	300
8	0==	150

Most printers, and even some modems, run at this baud rate. Check the manual for the terminal or modem you are connecting. If it is necessary to change this switch, turn the paddle to the OFF position, then turn the paddle that corresponds to the baud rate you desire ON.

To change SW2 for a 300 baud rate, for example, turn paddle 5 OFF, then turn paddle 7 to the ON position:

SW 2

ON

1	0==	19200
2	0==	9600
3	0==	4800
4	0==	2400
5	0==	1200
6	0==	600
7	==0	300
8	0==	150

If you experience any difficulty running your devices after changing the settings, consult the manual, or the dealer that sold you the equipment, to be certain you changed the switch to the proper setting.

D.5. Configuring the RS-232 Serial Ports

The connectors on the two serial plugs adhere to the EIA standards for RS-232 communication signals. There are 25 connectors, however, not all of them are used. The tables below describe the pin number arrangement and signals of these connectors:

Table D-1: RS-232 Serial Port Pin Arrangement - Rear View

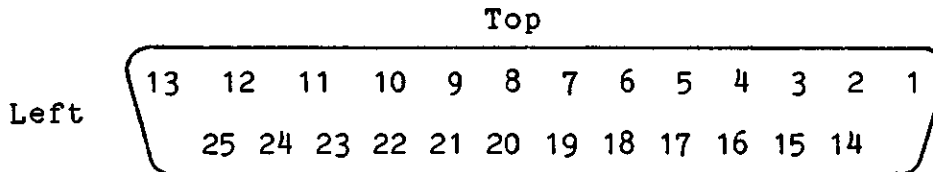

Table D-2: RS-232 Signal Descriptions

Pin #	Signal
1	Frame ground
2	Receive Data Input
3	Transmit Data Output
4	Request To Send Input
5	Clear To Send Output
6	Data Set Ready Input
7	Signal ground
8	Carrier Detect Output
20	Data Terminal Ready Input

D.5.1. Jumpers J1 and J2

At the front of each 25-pin serial port is a set of 8 pairs of jumper headers labeled J1 and J2 (internal view; refer to Figure D-2). These jumpers configure the RS-232 serial ports for connection of a terminal and printer or modem. Seven slip-on connectors are used to make the pin assignments. These jumper settings have a direct bearing on the function of the RS-232 serial ports. By switching two settings, the ports can be configured as a DTE or DCE (terminal or modem) devices.

Each set of jumpers corresponds to one of the signals on the serial port. This relationship is depicted in the following table:

**Table D-3: Micro Decision Serial Port
Terminal and Printer Configuration Blocks**

Pin #		(Connected to RS-232 Pin #)
1	TxD from terminal	2
2	TxD from UART	
3	RTS from terminal	4
4	RTS to UART	
5	CTS to terminal	5
6	CTS to UART	
7	CD output	
8	(not	
9	connected)	
10	CD input	8
11	DTR from terminal	20
12	DTR\ from UART	
13	DSR to terminal	6
14	DSR\ to UART	
15	RxD to terminal	3
16	RxD to UART	

Since jumper block 8 and 9 is not used, its slide-on connector may be used at other blocks to change the configuration. These jumper block may also be wire-wrapped if additional connectors are required.

CAUTION: Soldering to the jumper pins voids the system warranty.

The standard (factory set) jumper settings for J1 and J2 are depicted in the tables on the next page:

Table D-4: J1 - Terminal Configuration

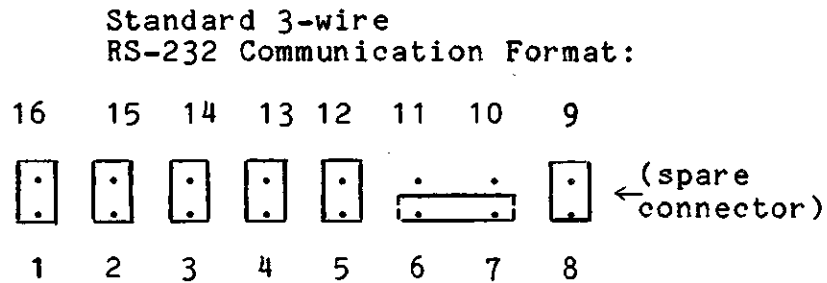
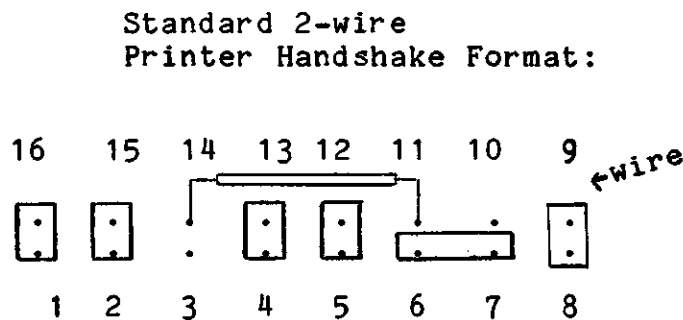

Table D-5: J2 - Printer Configuration



D.5.2. J2 - MODEM Configuration

MODEMs may be connected to the Micro Decision in one of two ways. One way requires a cable with pins 2 and 3 switched on one end. These cables are usually available at computer stores that sell MODEMs. The alternative to this, however, is to change the connectors on J2 to the following:

Table D-6: J2 - MODEM Configuration

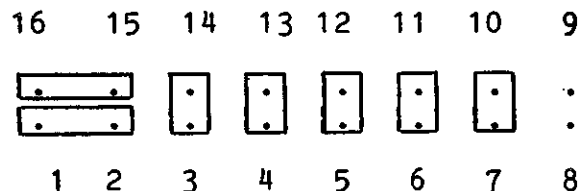

If you experience any difficulty running an I/O device on your Micro Decision, consult your manual, or the dealer that sold you the equipment.

D.5.3. About the Serial Ports

Both serial ports on the Micro Decision use the Intel 8251A UART (Universal Asynchronous Receiver/Transmitter) chip. For information on how to program the UART, refer to an Intel or NEC data book.

The UARTs are I/O mapped and may be accessed at the following locations:

OFCH	Terminal UART DATA port
OFDH	Terminal UART COMMAND/STATUS port
OFEH	Printer UART DATA port
OFFH	Printer COMMAND/STATUS port

D.5.4. CP/M Device Definitions

The Micro Decision has all four logical devices implemented as follows:

CON:	Morrow Designs Terminal
LST:	Printer/MODEM port (supports XON/XOFF handshaking)
RDR:	Printer/MODEM port (input)
PUN:	Printer/MODEM port (output)

E. GLOSSARY

ALLOCATE - Assignment of space or function for a specific task.

APPLICATION PROGRAM - Usually a commercially available program that tells the computer how to do a specific job, such as word processing or payroll accounting.

BACK-UP COPY - A copy of files (programs or data) kept as a spare in case the original file is destroyed.

BAUD RATE - Rate of character transmission speeds over asynchronous communication devices such as printers, terminals and MODEMS. Named for Emil Baudot, a pioneer in printing telegraphy.

BIT - A contraction of "binary digit;" the basic unit of information used by the computer. Eight bits equals one byte (see BYTE).

BOOT - Short for "bootstrap." A bootstrap program contains instructions that allow the computer to be placed in a desired state by means of its own actions. Microcomputers are readied for use by a bootstrap program (see COLD START).

BYTE - The representation of a single character. A sequence of eight bits treated as a single unit; also the smallest addressable unit within the system.

CAPACITY - Amount of data that can be stored on a magnetic storage device (diskette, for example); usually described in terms of k bytes, where one k = 1024 bytes.

CHARACTER - Synonymous with byte. One character is made up of 8 bits.

CHIPS - Small (about 3/8 inch square) pieces of silicon that contain computer logic and circuitry for processing, memory and input/output functions. Chips are soldered together on a printed circuit board to form the microcomputer.

COLD START - Procedure to start up a computer that is currently off or has undergone a serious failure. The Micro Decision uses a bootstrap program to bring itself up (see BOOT).

COMMAND - Instruction entered by the user at the terminal keyboard to direct the actions of the computer.

COMPATIBILITY - The ability of one computer to accept and process data by another computer without modifying the data or the media upon which it is being transferred.

COMPUTER PROGRAM - A set of instructions written for a computer that enable it to achieve a desired result.

CONFIGURATION - A group of devices (such as terminals, printers, disk drives, etc.) connected to a computer that has been programmed to operate them as a single system.

CONTROL KEYS - Key or a sequence of keys entered at the keyboard to initiate a particular function within a program.

CPU - Central Processing Unit. The "brains" of the computer where instructions and data are interpreted and executed.

CURSOR - Indicates position on the terminal screen; may be a small rectangle, line or triangle.

DATA - The facts, numbers, letters, symbols, etc. processed or produced by the computer.

DISKETTE STORAGE - Storing of data on magnetic disk. Data is arranged on concentric tracks much like a phonograph record.

ERASE - Complete removal (obliteration) of data from a diskette or other data storage device.

EXECUTE - The process of entering a command that the computer can successfully perform or carry out.

FILE - A single named collection of data, such as a manuscript or a list of addresses, that can be recalled by the computer.

FIRMWARE - Specific software instructions permanently placed into the computer's internal memory chips.

FLOPPY DISKETTE - Small, flexible disks that store magnetically encoded data used on the microcomputer.

FORMAT - Structure of a diskette that the operating system expects before it writes files or programs onto the diskette.

HARDWARE - Contrasts to software; the physical computer equipment and components, such as the magnetic, electronic and mechanical devices.

INPUT - Data entered into the computer to be processed from the keyboard, or the transfer of data from external storage to internal storage devices.

I/O - Input/Output; refers to acceptance and transfer of data to and from a computer.

I/O DEVICES - Devices used to communicate with the computer and transfer data to and from it.

INSTRUCTION - Statement in a computer program specifying a particular function or task to be performed.

k - Taken from Greek word "kilo" meaning 1000; equivalent to 1024, or 2 raised to the 10th power (see BYTE).

LANGUAGE - A means of conveying information to the computer that is governed by a set of defined rules and conventions.

MASS STORAGE - On-line secondary data storage devices, such as floppy disk subsystems, that are readily accessible by the CPU.

MODEM - Contraction of MODulator-DEMulator; communication device that transmits information between computers via telephone lines.

OPERATING SYSTEM - An operating system has many important functions in a computer system. It is a collection of instructions and software programs that link the user to the computer, allowing him to work efficiently with it. It also controls the operation of the system, taking care of command and program execution, displaying error messages at the appropriate times, directing data to the proper places, etc. The Micro Decision operates with the CP/M™ operating system.

PRINTER - An output device that produces a "printout" or "hard copy" of computer data. Output is measured in the amount of words printed per second, with dot matrix printers being faster than letter quality printers.

RAM - Random Access Memory; high speed memory locations within the computer circuitry itself.

RS-232 - A specification established by the Electronic Industries Association governing the interface requirements between MODEMs and terminals or computers.

SOFTWARE - The programs that govern the operation of the computer and make the hardware run.

TERMINAL - A typewriter-like keyboard and CRT (cathode ray tube) display screen connected to the computer for input/output of data.

USER - Person who uses a computer.

WARM START - Re-starting or resetting a computer after a temporary failure or interrupt of normal activity; temporary failure has not disturbed back-up storage.

F. RECOMMENDED READING

An Introduction to Microcomputers, Vols 0-3, Osborne/McGraw-Hill, 1980

CP/M™ Primer, by Stephen M. Murtha and Mitchell Waite, Howard W. Sams & Co., Inc., 1980.

Using CP/M™ - A Self-Teaching Guide, by Judi N. Fernandez and Ruth Ashley, John Wiley & Sons, Inc., 1980.

The CP/M™ Handbook with MP/M, by Rodnay Zaks, Sybex, 1980.

Mastering CP/M™, by Alan R. Miller, Sybex, 1982.

Wordstar Made Easy, by Walter A. Ettl, Osborne/McGraw-Hill, 1981.

Introduction to Wordstar, by Arthur Naiman, Sybex, 1982.

Introduction to Word Processing, by Hal Glatzer, Sybex, 1981.

DON'T (Or How to Care For Your Computer), by Rodnay Zaks, Sybex, 1981.

Your First Computer, A Guide to Business and Personal Computing, by Rodnay Zaks, Sybex, 1981.

BASIC for Business, by Douglas Hergert, Sybex, 1982.

INDEX

A

ASCII character set, 48
AUTO,
 cancelling, 38
 command, 25
 examples of, 38
 execution of commands with, 37
AUTO.COM, 37, 38
Aborting commands, 53
Accessing data, 4, 9, 43
Additional Disk Drives, 4
 external, 4
 internal, 4
Allocate, 65
Allocation of disk space, 4, 9, 29
Application programs, 1, 4, 7, 15, 23, 65
 diskette containing, 53
 working copies of, 30
Arithmetic functions, 16
Automatically running
 programs (see AUTO), 37

B

BACK SPACE, 14
BASIC™, 1, 2, 16
 exiting from, 53
BOOT ERROR, 42
BaZic™, 1, 2
Back panel connections, 3
Back-up copies, 12, 28, 31, 41, 55, 65
Backing-up diskettes, 12
Baud rate,
 Micro Decision, 48, 52, 58
 changing the, 58
 defined, 65
 described, 57
 modem, 61
 switches on the Micro Decision, 60, 61
 terminal, 49
Binary digit, 65
Bits, 2, 57, 65
 8-bit, 2
 16-bit, 33
 data, 58
 defined, 65
 parity, 49, 58
 per second (see Baud rate), 57
 start, 49, 57, 58
 stop, 49, 57, 58

B. Cont.

Boot, 65
Booting errors, 42
Booting the system, 19, 24, 27, 37, 41, 42, 65
Bootstrap, 65
Brightness control
 Morrow Designs Terminal, 20
Bugs, 41
Bytes, 2, 8, 9, 47, 65

C

CAP LOCK, 13
CHECK DISKETTE AND FILE SIZE, 29
COM programs
 AUTO, 37, 38
 DIR, 37, 54
 ERA, 55
 PIP, 42
 REN, 54
 STAT, 38, 44
 SYSGEN, 42
 TYPE, 53
COPY A FILE (PIP), 28
CP/M™,
 2.2, 2, 53
 86, 5, 33
 Control Program for Microcomputers, 1
 DIR command, 28, 37, 54
 ERA command, 55
 FORMAT command, 29
 PIP command, 28, 30
 REN command, 54
 STAT command, 29, 35, 44
 SYSGEN command, 29
 TYPE command, 28, 53, 54
 built-in commands, 37, 53
 commands, 5, 27, 28, 53
 enhanced operating system, 4, 41, 44
 manual, 42
 operating system, 1, 2, 7, 9, 33, 42, 53
 prompt, 30
 software, 4
 systems, 35
 unmodified version, 41
CPU, 47, 66
 280A, 2, 8, 33, 47
 operating speed, 47
CREATE A WORKING OR SYSTEM DISKETTE, 28
CTRL, 14
CTRL C, 28, 53, 54
CTRL P, 54
CTRL S, 28, 54

C, Cont.

Cables, 18, 51
 RS-232, 18
 connecting, 18
Capacity, 65
Care of diskettes, 10
Central Processing
Unit (see CPU), 8
Changing logged drive, 54, 55
Characters (see also
Bytes), 8, 9, 57, 65
Cheater plug, 18
Checking available diskette
space (also see STAT), 35
Chips, 65
Circuit board, 65
Cold start, 27, 65
Commands, 5, 13, 14, 15, 25, 27,
28, 29, 30, 35, 38, 44, 54, 55
 AUTO, 37, 38, 39
 CP/M™, 53
 CP/M™ built-in, 37, 53, 55
 WordStar™, 36
 aborting, 53
 defined, 65
 execution of, 66
 non-reversible, 55
 to correct error messages, 45
Communication format
 standard RS-232 3-wire, 64
Communication mode
 terminal, 49
Communication programs, 4
Communications protocol, 58
Compatibility, 65
 IBM PC®, 5, 33
 NorthStar®, 2
 Osborne I®, 4, 33
 Xerox 820®, 4, 33
Computer program, 65
Communication devices
 (see also I/O device), 65
Configuration, 66
Control keys, 66
Copying files, 28
Correct-It, 2
Creating working program
diskettes, 30, 31
Creating an AUTO diskette, 37
Cursor, 21, 48, 66
Customer service, 5

D

- DATA ERROR, 43
- DCE devices (see also Modem), 62
- DELETE, 15
- DIR, 54
- DISKETTE READ ONLY, 44
- DISPLAY A DISKETTE DIRECTORY (DIR), 28
- DRIVE NOT READY, 42
- DTE devices (see also Terminal), 62
- Data, 7, 29
- Data base management systems, 4
- Data, (see also Information) 9, 66
 - diskettes, 4
 - files, 33
 - storage, 7, 8
 - transfers, 9, 19, 23, 33, 43, 65
 - transmissions, 57
- Diagnostic test
 - built-in system, 21, 22, 27, 51
 - built-in terminal, 49
- Discs (also see Diskette), 8
- Disk drive controller, 2
- Disk drive, 4, 23, 25
 - A, 11, 22, 23, 24, 27, 34, 35, 36, 38, 42, 54
 - B, 11, 24, 54
 - C, 11, 36
 - D, 11
 - E, 35
 - cable, 42
 - door, 10, 42, 44
 - emulating foreign formats, 33
 - external, 18
 - latch, 10
 - logged, 54
 - non-existent, 34
 - not ready, 42
 - operations, 45
 - physical, 34
 - redefinini<, 34
 - specifications, 47
 - valid addresses, 44
- Diskette
 - AUTO, 37
 - Micro Decision format, 3, 4
 - SYSTEM, 23, 27
 - accessing data on, 43
 - back-up copies, 12, 24, 31, 41
 - cardboard shield, 10
 - compatible formats, 4, 5, 33
 - configuring, 44
 - data, 9, 11, 12, 29
 - data transfer to, 19
 - description of, 9, 10

D, Cont.

Diskette (cont.),
distribution, 12, 23, 30, 31, 43
erasing data from, 29, 44
faulty, 42, 43, 45, 52
file space on, 29, 35
floppy, 8
foreign, 33
formatted storage capacity, 47
formatting, 24, 29, 33, 37
handling, 3, 10
improperly formatted, 43
inserting, 11, 51
label, 10
non-system, 42
program, 9, 11, 12, 29
re-configuring, 39
reading data from, 42, 43
rules for handling, 10
soft sector format, 4
specifications, 47
swapping, 35, 36
transferring data to, 33, 43
where to buy, 3
with CP/M™ system, 42
with terminal configured, 25
working system, 22, 28, 30, 31
write protected, 12
writing data to, 42, 43
Disks (see also Diskette), 8
Display screen (see also Terminal), 17
Displaying files
with CP/M™, 53
with WordStar™, 53
Distribution diskettes, 23
Dual drive systems, 4

E

EIA, 18
Electronic Industries Association, 57
RS-232 connection standard, 49, 62
ENTER key, 13
EPROM, 47
ERA, 55
ESC, 13
ESC key, 30, 31
EXECUTE A CP/M COMMAND, 29
EXIT TO CP/M (ESC), 30
Emulating foreign diskette format, 33, 34
Emulating
IBM CP/M-86™ system, 34
Osborne I system, 34
Xerox 820 system, 34
Enhanced operating system. (see also CP/M™), 9

E, Cont.

Erasing
 characters, 14
 data, 3, 9, 29
 diskettes, 12, 44
 memory, 19
Error control codes, 43
Error messages, 22
Errors
 BOOT ERROR, 42
 DATA ERROR, 43
 DISKETTE READ ONLY, 44
 DRIVE NOT READY, 42
 FILE READ ONLY, 44
 LOST DATA, 43
 NO SYSTEM, 42
 NOT FOUND, 43
 SELECT ERROR, 44
 WRITE PROTECTED, 43
 booting, 41, 42
 categories of CP/M™, 41
 detecting, 41
 messages, 41
 non-recoverable, 41, 43
 recoverable, 41, 42
 recovery from, 43
 software (see also Bugs), 41
 trapping, 41
Exchanging programs, 3
Executing commands, 13
External disk drives, 4, 18

F

FILE READ ONLY, 44
FORMAT A DISKETTE (FORMAT), 29
File, 7
 data, 8
 program, 8
 saving, 35
Financial modeling, 1
Floppies (see also Diskette), 8
Foreign diskettes, 33
Format
 Micro Decision diskette, 3, 4, 33
 a diskette, 24, 29, 33, 37
 communications, 64
 compatible diskette, 4, 5, 33
 diskette storage capacity, 47
 foreign diskette, 33
 printer handshake, 64
 terminal screen, 33, 48
Front panel
 buttons, 19
Full duplex mode, 49

P, Cont.

Printer and modem baud rates, 61
Printer
 baud rate, 58
 dot matrix, 3
 letter quality, 3
 plugs, 3
 serial, 58
 standard 2-wire handshake format, 64
Printing files
 with CP/M™, 53, 54
 with WordStar™, 53
Program, 7, 8, 9, 29
Program diskettes, 4
Program
 "bugs", 41
 diskettes, 33
 execution of, 8, 15
 explained, 7
 termination of, 19
Programmable function keys
 Morrow Design Terminal, 49
Programming
 languages, 1, 16
 with computer, 1

R
RAM, 2, 9, 47
 Random Access Memory, 8
 diagnostic, 22
REN, 54
RESET button, 19, 23, 51
RETURN key, 15, 22, 24, 27, 30, 37, 38
RFI (Radio Frequency Inhibiting) metal, 47
ROM
 diagnostic, 22
RS-232 interface, 49
RS-232 serial ports, 2, 3, 18
 Micro Decision, 48, 57, 62
RS-232 signal descriptions, 62
RUN A PROGRAM, 28
Re-assigning a drive (see also
Virtual Drive), 36
Re-defining the drive, 33, 34
Re-entering the menu program, 30
Re-loading system (also see Warm boot), 45
Rear panel
 connections, 57
 switches, 19
Reconfiguring a diskette, 44
Rules for handling diskettes, 10

S

SELECT ERROR, 44
SHIFT, 13
SPECIAL SYMBOLS, 16
STAT.COM, 38, 44
SYSGEN.COM, 42
SYSTEM DISKETTE, 25, 27, 31, 34, 35, 42,
51, 52
 back-up copy, 28
 configuring for terminal, 24
 creating, 24
 instructions for creating, 23
Saving a file, 35
Screen format, 33
Scrolling,
 described, 28
 text, 53, 54
Serial I/O, 48
Serial communication, 57
Serial device (see also I/O device), 3
Serial interface, 3
Single drive systems, 4
Software, 1, 2, 7, 23, 41
Special programs, 1
Start bit, 57, 58
Stop bit, 57, 58
Storage capacity, 65
Swapping diskettes, 4, 9, 35, 36
System failures, 19

T

TYPE, 53
Telephone line, 3
Temporary data storage (see also RAM), 8
Terminal Baud Rates, 60
Terminal, 1, 2, 16, 23, 27
 Morrow Designs, 1, 21
 Selection Menu, 24
 baud rate, 58
 connection of, 57
 serial interfaces for, 3
 specifications for Morrow Design, 48
Transferring data, 43
Trapping errors, 41
Turnkey system, 37
Types of software, 7

U

User, 41
Users groups, 46

G
Games, 4

H
Half duplex mode, 49
Handling diskettes, 3
Handshaking, 58
 CTS, 58
Hardware, 1, 2, 3, 7, 8, 41

I
I/O, 57
I/O device, 57, 58, 64, 66
IBM.COM, 34
Indicator light, 51
Information services
 CompuServe, 3
 The Source, 3
Information
 magnetically encoded, 9
 transfer of (see also Data), 9
Inserting diskettes, 11
Internal disk drive, 4

J
J2 - Modem configuration, 64
Jumpers J1 and J2, 62
Jumpers
 Micro Decision internal, 62

K
K bytes, 8, 65
Keyboard, 13, 17, 38, 66
 specifications, 49
Keys
 BACK SPACE, 14
 CAP LOCK, 13
 CTRL, 14
 DELETE, 15
 ESC, 13
 RETURN, 15
 SHIFT, 13
Kilobyte, 8

L

LOST DATA, 43
Languages, 7
 assembly, 7
 compatible, 7
Loading the system (see also Warm boot), 42, 52, 53
Logged drive, 42, 54, 55
LogiCalc™, 2, 8, 16, 29

M

MAKE A BACKUP DISKETTE
 (FORMAT, SYSGEN, PIP), 29
Magnetic fields, 10
Magnetically encoded information, 9
Menus, 13, 31
Micro Menus, 1, 2, 5, 23, 25, 27, 30, 42, 53
 Main Menu, 27, 28, 31
Microprocessor
 16-bit, 33
 8-bit, 2
Modem, 3, 18, 57
 configuring system for, 64

N

NO SYSTEM, 42
NOT FOUND, 43
NUMERIC KEYPAD, 15
Non-reversible command, 55
Numeric entries, 15

O

OSB.COM, 34
OTHER OPTIONS (REN, ERA, STAT), 29
On-line storage, 4
Operating system, 7

P

PIP.COM, 42
Permanent data storage
 (see also Diskette), 8
Physical drive, 35
Pilot, 1, 2, 7, 53
Plugs, 18, 51
Power cord
 Micro Decision, 58
Power switch
 Micro Decision, 19
 Morrow Designs Terminal, 20
Printer, 1, 3, 18, 57

V

VIEW OR PRINT A FILE (TYPE, PIP), 28
Valid drive selection, 44
Virtual Drive feature, 4, 9, 30, 34, 35
 example using WordStar™, 36
 examples, 35

W

WRITE PROTECTED, 42
Warm boot, 45, 53, 54
Word processing, 1, 7, 65
WordStar™, 2, 7, 8, 14, 29, 38
 commands, 35
 working diskette, 30
Working copies of programs, 30
Write protecting diskettes, 12
Write protect, 42
 notch, 12, 43
 tab, 12

X

XER.COM, 34

Z

Z80A CPU, 2