

88-ACR
DOCUMENTATION



MTS

a subsidiary of **Pertec Computer Corporation**

88-ACR
AUDIO CASSETTE INTERFACE
DOCUMENTATION

© MITS, Inc. 1975

Second Printing, February, 1977

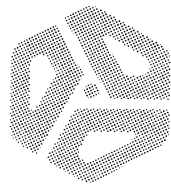

mits

a subsidiary of **Pertec Computer Corporation**
2450 Alamo S.E. / Albuquerque, New Mexico 87106

88-ACR ASSEMBLY

The 88-ACR consists of two separate PC boards mated to each other to form a single unit. One of these is the ACR Modem Board and the other is the 88-SIO B, Serial TTL level I/O Board. The Modem board is used to key the signals into the correct audio tones and back, while the SIO B board is used to interface with the computer itself.

The first step in constructing the 88-ACR is assembling the SIO B Board. The following section is the standard SIO B Board documentation.

THEORY of OPERATION

88-SIO SERIAL INTERFACE BOARD OPERATION

The serial interface board provides communication between the ALTAIR and any serial Input/Output devices. The board has two device code addresses which are hardware selectable by jumpers for any even numbered address from 0 to 376 (octal). The BAUD rate is also selectable, via jumpers, from 0 through 25,000 BAUD. This board also provides both hardware and software interrupt capability.

Device Select Logic

When the CPU executes an "OUT" or an "IN" instruction, it places the device address (provided with the instruction) on both the 8 lower order address bus lines and the 8 higher order address bus lines.

The 8 lower order address bus lines are fed to the select logic on the board, IC's H & J. If the address on the bus is equal to the address selected on the board, IC I pin 8 will go low, thus enabling IC J pins 3 & 6.

Depending on the state of A0 (the least significant address bit), either the control channel or the data channel will be enabled. If A0 is at a logic low level, IC J pin 4 will go high, thus enabling the control channel. If A0 is at a logic high level, IC J pin 1 will go high, thus enabling the data channel.

Of the two device addresses on the board, the control channel is always an even number and the data channel is always an odd number.

Control Channel

The control channel has two purposes: it is used to enable/disable the hardware interrupt capability for the Input or Output device, and to test the status of the Input/Output device.

After an "IN" instruction is executed with the control channel address, "SINP" goes high and IC J pin 4 is high thus causing IC G pin 3 to go low. This causes IC E pin 13 and IC D pin 8 to go low, thus enabling the Data In lines. (Note that IC D pin 12 is always high except during the initial power on clear, POC.) SWE (Status Word Enable) is always enabled except when inputting data (see Data Channel explanation). This results in the status being inputted to the Data In lines and into the CPU accumulator.

The eight data bits are defined in the chart on the following page.

Bit Definition

| DATA BIT | LOGIC LOW LEVEL | LOGIC HIGH LEVEL |
|----------|---|--|
| 7 | Output device Ready (X-mitter buffer empty) Also causes a hardware interrupt to occur if interrupt enabled* | Not Ready |
| 6 | NOT USED | NOT USED |
| 5 | NOT USED | |
| 4 | | Data Overflow (a new word of data has been recieved before the previous word was inputed to the accumulator) |
| 3 | | Framming Error (data word has no valid stop bit) |
| 2 | | Parity Error (recieved parity does not agree with selected parity) |
| 1 | NOT USED | |
| 0 | Input device Ready Data is available for computer to input * | NOT READY |

When an "OUT" instruction is executed with the control channel address, data bits 0 & 1 are gated through IC's E & A to the Input/Output interrupt flip-flops, IC B.

The chart below describes the result of setting these two bits.

| <u>D0</u> | <u>D1</u> | <u>OUTPUT INTERRUPT</u> | <u>INPUT INTERRUPT</u> |
|-----------|-----------|-------------------------|------------------------|
| low | low | disabled | disabled |
| low | high | enabled | disabled |
| high | low | disabled | enabled |
| high | high | enabled | enabled |

As an example: to enable the input device and disable the output device interrupts, load the accumulator with the following:

(X = don't care)

| <u>D7</u> | <u>D6</u> | <u>D5</u> | <u>D4</u> | <u>D3</u> | <u>D2</u> | <u>D1</u> | <u>D0</u> |
|-----------|-----------|-----------|-----------|-----------|-----------|-----------|-----------|
| X | X | X | X | X | X | 0 | 1 |

then execute an "OUT" instruction with the control channel address.

Data Channel

The data channel transfers the data between the device and the CPU.

An "OUT" instruction, accompanied by the data channel address (odd numbered address), will pull "SOUT" and IC J pin 1 high, causing IC G pin 11 to go low. As soon as the CPU has put the data from the accumulator onto the data out bus, PWR goes low pulling IC S pin 4 low to strobe TDS (Transmit Data Strobe) at pin 23 of IC M. This causes the parallel data on the bus to be loaded and then transmitted serially. Pin 4 of IC S also resets the output ready flip-flop (IC F-b) to clear the busy signal to the device.

An "IN" instruction with the data channel address will pull "SINP" and pin 1 of IC J high causing pin 8 of IC G to go low, thus enabling RDE (Recieved Data Enable) at pin 4 of IC M and the Data In lines (IC D pin 8). This also disables SWE at IC E pin 10. This puts the recieved data on the bus and the CPU strobcs it into the accumulator during DBIN (Data Bus In). Pin 8 of IC G also resets the input ready flip-flop (IC F-a) and the UART Data Available flip-flop, RDAV at pin 18 of IC M.

UART

The Universal Asynchronous Reciever-Transmitter (UART) provides the paralled to serial and serial to parallel data conversion necessary to interface a serial device with the parallel ALTAIR. It also has a status word for "handshake" and error checking.

Both the Receiver and the Transmitter require a clock input frequency that is 16 times the BAUD rate. This is accomplished with a 12 bit presettable counter (IC's P, Q & R) and a single shot (IC O). If the frequency required is not found in the "BAUD RATE SELECTION CHART" included in this manual, use the formula below:

$$\text{Preset Count Frequency} = 4100 - \left(\frac{\text{Period of Output Frequency (us)}}{.5\text{us}} \right)$$

The maximum frequency is 400KHz. The maximum BAUD rate is (400K/16) 25,000 BAUD.

The UART (IC M) has several programable functions as described below.

| <u>UART PIN #</u> | <u>NAME</u> | <u>FUNCTION</u> | | | | | | | | | | | | | | | |
|-------------------|--------------|--|-------------|-------------|------------------|-----|-----|-----|------|------|------|------|------|-----------------------|------|------|---|
| 35 | NPB | Eliminates parity bit from being transmitted when tied high (see pin 39, POE) | | | | | | | | | | | | | | | |
| 36 | NSB | When tied low, one stop bit is transmitted When tied high, two stop bits are transmitted | | | | | | | | | | | | | | | |
| 37 38 | NDB2 NDB1 | Defines the number of data bits per character as shown below: | | | | | | | | | | | | | | | |
| | | <table border="1"> <thead> <tr> <th><u>NDB2</u></th> <th><u>NDB1</u></th> <th><u># of Bits</u></th> </tr> </thead> <tbody> <tr> <td>low</td> <td>low</td> <td>5</td> </tr> <tr> <td>low</td> <td>high</td> <td>6</td> </tr> <tr> <td>high</td> <td>low</td> <td>7</td> </tr> <tr> <td>high</td> <td>high</td> <td>8</td> </tr> </tbody> </table> | <u>NDB2</u> | <u>NDB1</u> | <u># of Bits</u> | low | low | 5 | low | high | 6 | high | low | 7 | high | high | 8 |
| <u>NDB2</u> | <u>NDB1</u> | <u># of Bits</u> | | | | | | | | | | | | | | | |
| low | low | 5 | | | | | | | | | | | | | | | |
| low | high | 6 | | | | | | | | | | | | | | | |
| high | low | 7 | | | | | | | | | | | | | | | |
| high | high | 8 | | | | | | | | | | | | | | | |
| 39 | POE | If NPB is tied low, POE defines whether parity will be odd or even as shown below: | | | | | | | | | | | | | | | |
| | | <table border="1"> <thead> <tr> <th><u>POE</u></th> <th><u>NPB</u></th> <th><u>PARITY</u></th> </tr> </thead> <tbody> <tr> <td>low</td> <td>low</td> <td>odd</td> </tr> <tr> <td>high</td> <td>low</td> <td>even</td> </tr> <tr> <td>X</td> <td>high</td> <td>none (X = don't care)</td> </tr> </tbody> </table> | <u>POE</u> | <u>NPB</u> | <u>PARITY</u> | low | low | odd | high | low | even | X | high | none (X = don't care) | | | |
| <u>POE</u> | <u>NPB</u> | <u>PARITY</u> | | | | | | | | | | | | | | | |
| low | low | odd | | | | | | | | | | | | | | | |
| high | low | even | | | | | | | | | | | | | | | |
| X | high | none (X = don't care) | | | | | | | | | | | | | | | |

Interrupt

The serial board is provided with hardware interrupt capability. The pads on the board labeled "OUT", "IN" & "BH" are provided for interrupt control. These three pads represent the Output device, the Input device or Both devices and are jumpered to one or more of the pads labeled "VI" and numbered 0 through 7 at the bottom of the board.

"VI" represents "Vectored Interrupt" and the numbered pads, 0 through 7, are the 8 interrupt lines which connect into the Vectored Interrupt Board (88-VI). The numbers 0 through 7 correspond to the 8 priority levels, with 0 being the lowest and 7 the highest priority.

You can assign the input device and the output device each a different priority, or you can assign both devices a single priority. If you do not have the 88-VI board, you can jumper one of the three pads ("OUT", "IN" & "BH") on one of your I/O boards to the processor input interrupt line.

The processor input interrupt line has a pad labeled "INT" on the board (see assembly manual). This will allow one level of interrupt to the processor. When the interrupt occurs, the processor will immediately jump to the location 70 (octal) and begin execution. Place your interrupt service routine in locations 70 through 77 (octal).

SERIAL I/O INTERFACE OPERATION

The 88-SIO A Board is a standard RS-232 level interface board.

The output, "TSO" is normally marking (a logic low level) which causes Q4 to turn on and the output signal, "STSO" is thus held positive (+3v). The serial data pulses cause Q4 to turn on and off, shifting the signal from the 0 & +2 volt TTL levels to +3 and -12 volt RS-232 levels respectively.

The incoming RS-232 signals (+3v & -12v) on "SRSI" cause Q3 to turn on and off. This shifts the signals to "RSI" to normal TTL levels (0v & +2v).

The 88-SIO B Board is a standard TTL level interface board.

The incoming TTL serial data line, "SRSI", is buffered at IC U pins 9 & 10 to decrease the required input current to .5ma worst case.

"TSO", the serial transmit data line, is buffered through IC U pins 6 & 7 to increase the drive capability to 20 TTL loads (approximately 48ma).

The 88-SIO C Board is a standard TTY level interface board.

The two inputs, labeled "SRSI", are designed for connection to normally closed contacts (for a teletype, these are pins 3 & 4 on the teletype terminal block). This will normally pull IC U pin 9 low and pin 8 high, since diode D1 is reverse biased. When the contacts open, IC U pin 9 is pulled to approximately 4 volts by the divider R5 & R6, and IC U pin 8 goes low.

The serial output from IC M, "TSO", is inverted through IC U pins 5 & 6 and fed to the base of Q1. "TSO" is normally high, pulling IC U pin 6 low to turn Q1 on and allow current to flow from "STSO" through Q1 and R10 to +5volts. When "TSO" is low, Q1 turns off and presents a high impedance to "STSO".

88-ACR
SERIAL I/O BOARD
ASSEMBLY PROCEDURE



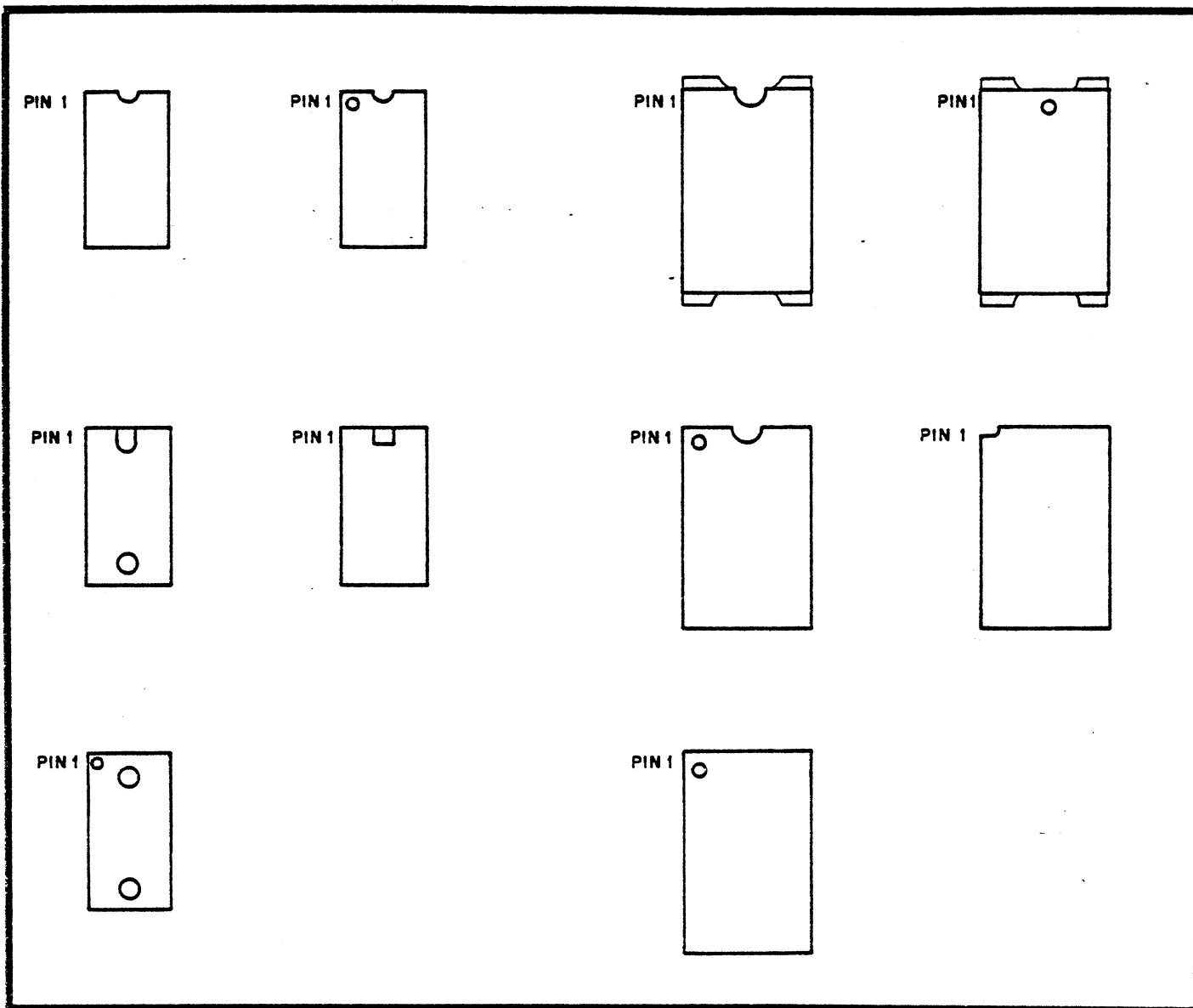

INTEGRATED CIRCUITS (ICs) CAN COME WITH ANY ONE OF, OR A COMBINATION OF, SEVERAL DIFFERENT MARKINGS. THESE MARKINGS ARE VERY IMPORTANT IN DETERMINING THE CORRECT ORIENTATION FOR THE ICs WHEN THEY ARE PLACED ON THE PRINTED CIRCUIT BOARDS. REFER TO THE ABOVE DRAWING TO LOCATE PIN 1 OF THE ICs, THEN USE THIS INFORMATION IN CONJUNCTION WITH THE INFORMATION BELOW TO PROPERLY ORIENT EACH IC FOR INSTALLATION.

WARNING: INCORRECTLY ORIENTED IC'S MAY CAUSE PERMANENT DAMAGE!

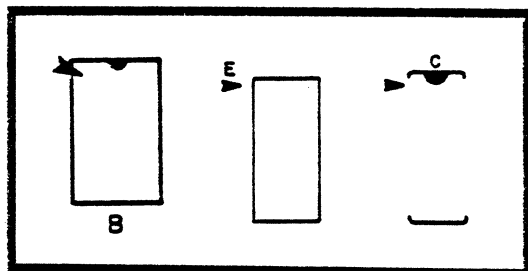

THE DRAWING ON THE LEFT INDICATES VARIOUS METHODS USED TO SHOW THE POSITION OF ICs ON THE PRINTED CIRCUIT BOARDS. THESE ARE SILK-SCREENED DIRECTLY ON THE BOARD. THE ARROWHEAD INDICATES THE POSITION FOR PIN 1 WHEN THE IC IS INSTALLED.

PRINTED CIRCUIT BOARD VISUAL INSPECTION

It is recommended that a visual inspection of the PC Board(s) in your kit be made before beginning the assembly procedures.

Look for etching "bridges" or etching "opens" in the printed circuit lands, as shown in the drawings below:

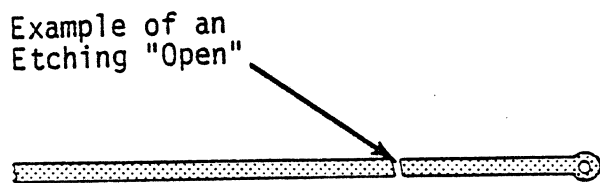
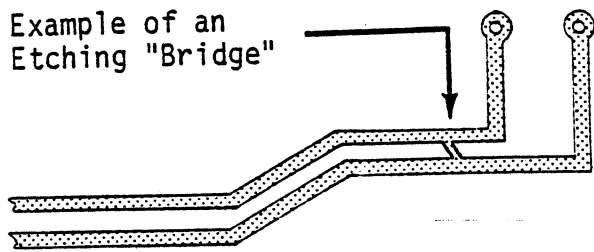

This could also appear as a "hairline" cut.

A thorough visual inspection will eliminate one possibility for errors, should the board not operate properly after it is assembled. Troubleshooting efforts may then be concentrated elsewhere.

8800 SERIAL I/O B BOARD ASSEMBLY

There are 19 integrated circuits (IC's) to be installed on the 8800 Serial I/O B Board. (88-SIOB) One of these, IC M, will be provided with a 40-pin IC socket. IC M itself should not be installed into the socket until the board is completely assembled.

- () Referring to the component layout, set the 40-pin IC socket included in your kit into place and secure it with a piece of masking tape. (see drawing below)

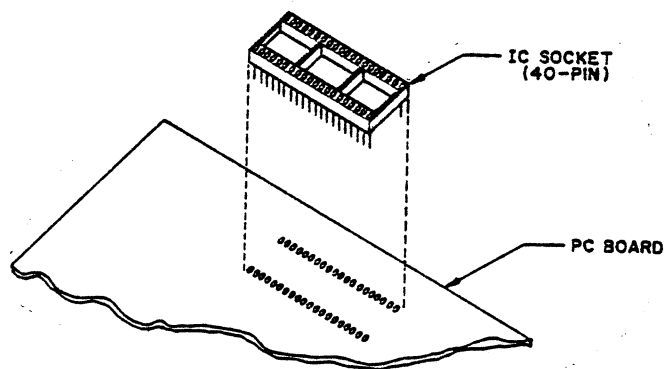

- () Turn the board over and solder each pin to the foil pattern on the back side of the board. Be sure to solder each pin and be careful not to leave any solder bridges.
- () Turn the board over again and remove the piece of masking tape.
- () Referring to the component layout, remove the IC with the correct part number from its holder. If there are any bent pins, straighten these using needle-nose pliers. Ensure that you choose the IC with the correct part number as you install each one.

- () Orient the IC so that its notched end is towards the arrowhead printed on the board, and pin 1 of the IC corresponds with the arrowhead itself.

NOTE: If the IC does not have a notch on one end, refer to the IC Orientation Chart included with your manual for the identification of pin 1.

- () When you have the correct orientation, start the pins on one side of the IC into their respective holes on the silk-screened side of the PC board. DO NOT PUSH THE PINS IN ALL THE WAY. If you have difficulty getting the pins into the holes, use the tip of a small screwdriver to guide them.
- () Start the pins on the other side of the IC into their holes in the same manner. When all of the pins have been started, set the IC in place by gently rocking it back and forth until it rests as close as possible to the board. Make sure that the IC is perfectly straight and as close as possible to the board; then tape it in place with a piece of masking tape.
- () Turn the board over and solder each pin to the foil pattern on the back side of the board. Be sure to solder each pin and be careful not to leave any solder bridges.
- () Turn the board over again and remove the piece of masking tape.

Use the same procedure to install each of the IC's. Be sure that you have the correct part number and the correct orientation as you install each one.

- () Install a 40-pin socket for IC M
- () IC's A, B, C, D, and G are 74L00's
- () IC's E and H are 74L04's
- () IC I is a 74L30
- () IC's J and S are 74L02's

- () IC's K, L, N and U are 8T97's
- () IC O is a 9601 (or 8T22A)
- () IC's P, Q and R are 74L193's

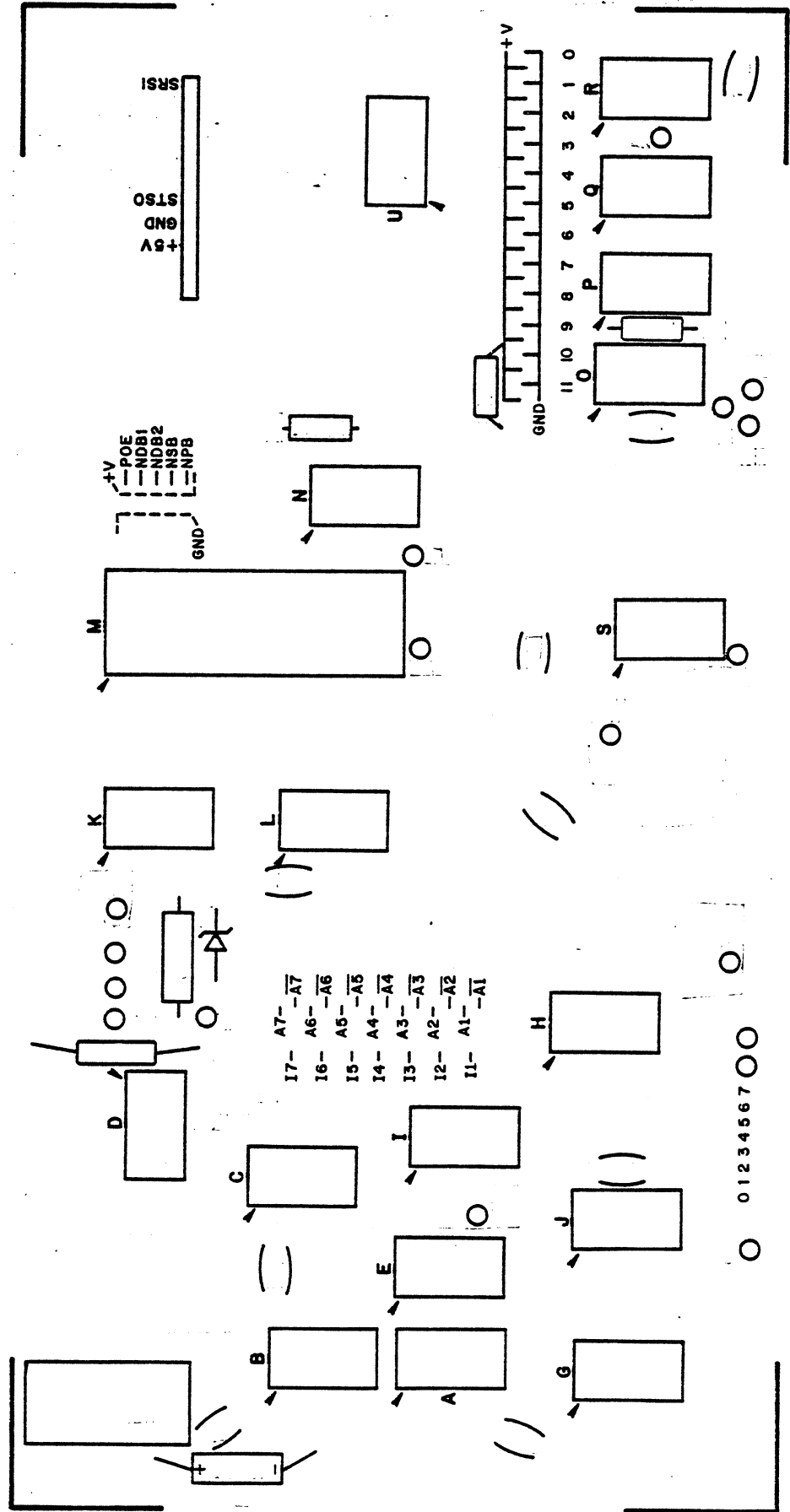

Resistor Installation

There are 4 resistors to be mounted on the 8800 Serial I/O B Board.

NOTE: Resistors are color-coded according to their value. The resistors in your kit will have four or possibly five bands of color. The fourth band in both cases will be gold or silver, indicating the tolerance. In the following instructions we will be concerned only with the three bands of color to one side of the gold or silver band. Be sure to match these three bands of color with those called for in the instructions as you install each resistor.

Using needle-nose pliers, bend the leads of the following resistors at right angles to match their respective holes on the PC board. (see component layout)

NOTE: All resistors on the 8800 Serial I/O B Board are either 1/4 or 1/2 Watt.

- () Install resistor R1 (130-ohm, brown-orange-brown) into the correct holes on the silk-screened side of the PC board.
- () Holding the resistor in place with one hand, turn the board over and bend the two leads slightly outward.
- () Solder the leads to the foil pattern on the back side of the board; then clip off any excess lead lengths.

Referring to the component layout, install the remaining resistors in the same manner. Be sure you have the correct color-coding for each one as you install them.

NOTE: Save all of the component leads that you clip off for use later in the assembly procedure.

- () R1 is 47-ohm (yellow-violet-black)
- () R2 & R3 are 2.2K-ohm (red-red-red)
- () R4 is 7.5K-ohm (violet-green-red)

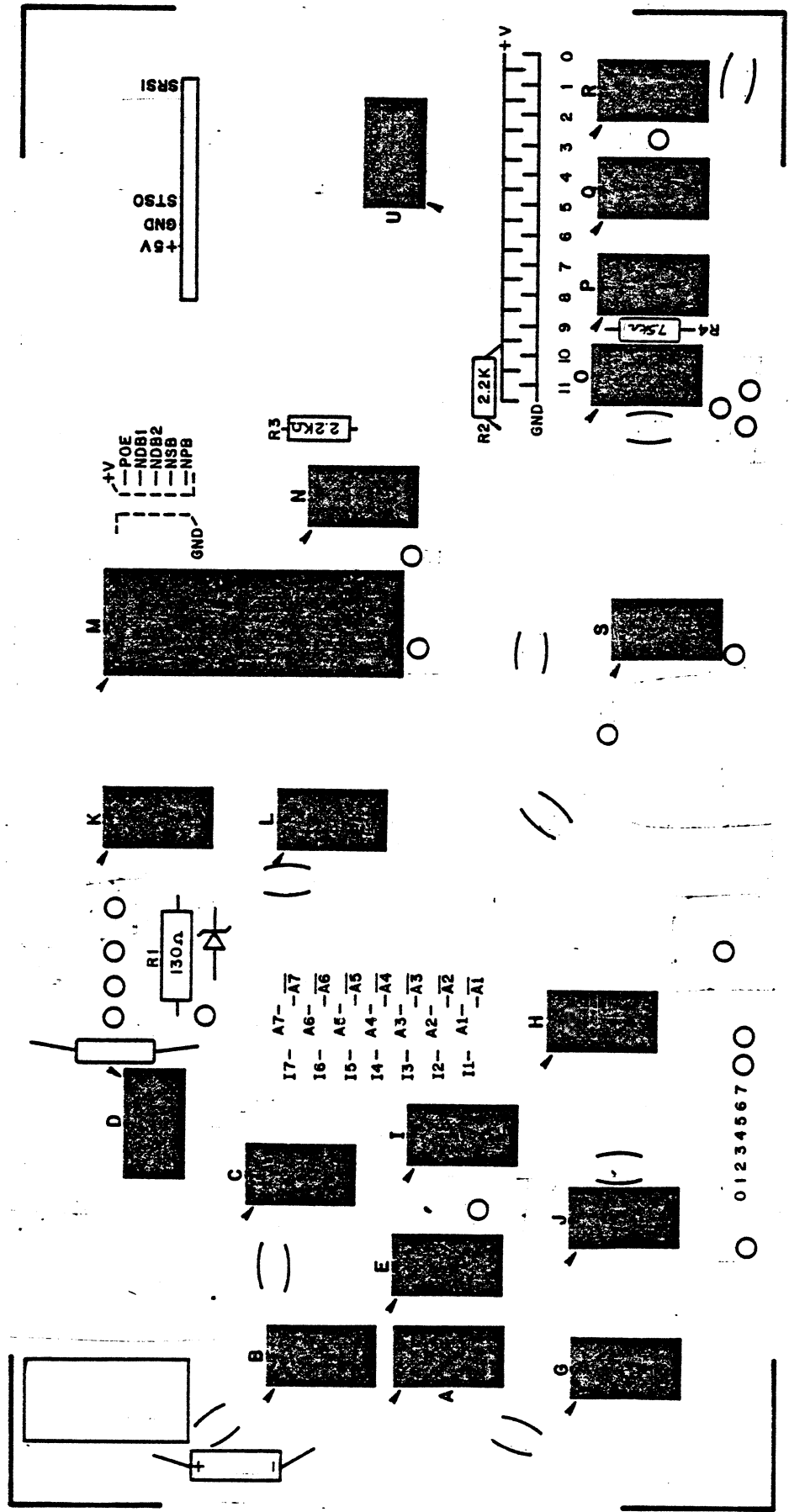

Capacitor Installation

There are 9 ceramic disk capacitors and 2 electrolytic capacitors to be installed on the 8800 Serial I/O B Board.

Refer to the component layout and install the ceramic disk capacitors according to the following procedure.

- () Choose the capacitor with the correct value as called for in the instructions. Straighten the two leads as necessary and bend them to fit their respective holes on the PC board.
- () Insert the capacitor into the correct holes from the silk-screened side of the board. Push the capacitor down until the ceramic insulation almost touches the foil pattern.
- () Holding the capacitor in place, turn the board over and bend the two leads slightly outward.
- () Solder the two leads to the foil pattern on the back side of the board; then clip off any excess lead lengths.

Install all of the ceramic disk capacitors in this manner. Be sure that you have the correct value capacitor as you install each one.

The two electrolytic capacitors for the Serial I/O Board have polarity requirements which must be noted before installation. Those contained in your kit may have one or possibly two of three types of polarity markings. To determine the correct orientation, look for the following: (see drawing above right)

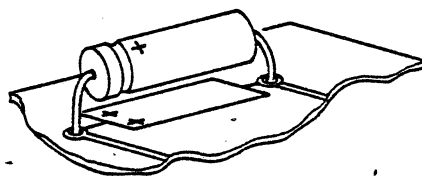

ELECTROLYTIC
CAPACITOR

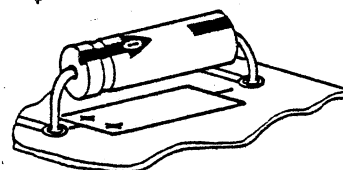

One type will have plus (+) signs on the positive end; another will have a band or a groove around the positive side in addition to the plus signs. The third type will have an arrow on it; in the tip of the arrow there is a negative (-) sign and the capacitor must be oriented so the arrow points to the negative polarity side.

Referring to the component layout, install the electrolytic capacitors on the board.

- () Bend the two leads of the capacitor with the correct value at right angles to match their respective holes on the board. Insert the capacitor into the holes on the silk-screened side of the board. Be sure to align the positive polarity side with the "+" signs printed on the board.
- () Holding the capacitor in place, turn the board over and bend the two leads slightly outward. Solder the leads to the foil pattern and clip off any excess lead lengths.
- () Install the second electrolytic capacitor in the same manner.

Diode Installation

There is one 12-volt zener diode to be installed on the 8800 Serial I/O B Board.

NOTE: Diodes are marked with a band on one end indicating the cathode end. The diode must be oriented so that the end with the band is towards the band printed on the board when being installed.

- () Referring to the component layout, bend the leads of zener diode Z1 at right angles to match the correct holes on the board.
- () Insert the diode into the correct holes from the silk-screened side of the board. Turn the board over and bend the two leads slightly outward.
- () Solder the two leads to the foil pattern on the back side of the board; then clip off any excess lead lengths.

() Z1 is a 12-volt zener diode

NOTE: The 12-volt zener will be marked "12V" or 1N4742.

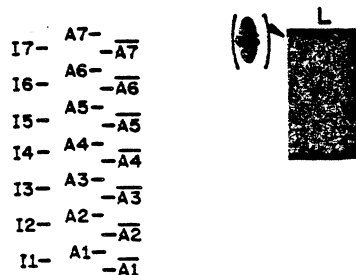
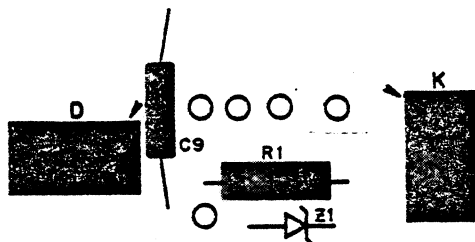

Voltage Regulator Installation

There is one MC7805 5-volt regulator to be installed on the 8800 Serial I/O B Board.

- () Set the MC7805 in place on the board and align the mounting holes. (see drawing)
- () Use a pencil to mark the point on each of the three leads where they line up with their respective holes on the board.
- () Use needle-nose pliers to bend each of the three leads at a right angle on the points where you made the pencil marks.

NOTE: Use heat-sink grease when installing this component. Apply the grease to all surfaces which come in contact with each other.

- () Referring to the drawing, set the regulator and heat sink in place on the silk-screened side of the board. Use the smaller, 6 pronged, heat sink instead of the 8 pronged one shown in the drawing. Secure them as shown, holding the regulator in place as you tighten the nut.
- () Turn the board over and solder the three leads to the foil pattern on the back side of the board. Be sure not to leave any solder bridges.
- () Clip off any excess lead lengths.

() Install VR (MC7805)

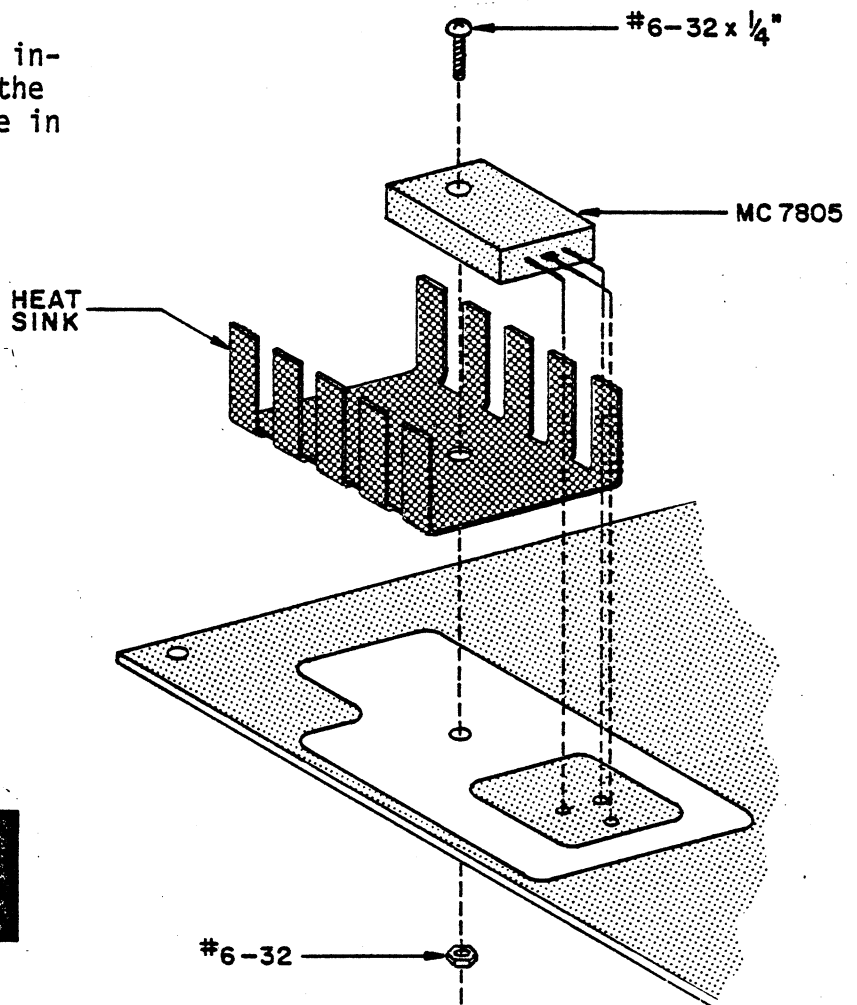
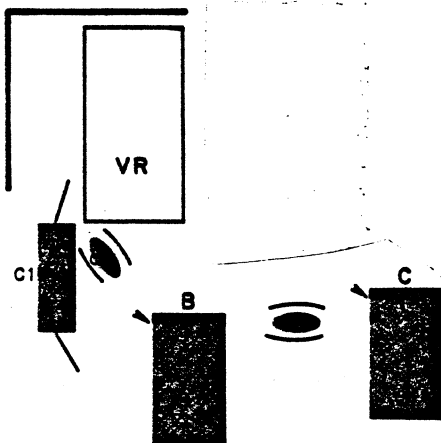

Hardwire Connections

There are 30 hardwire connections, with one optional connection, to be made on the 8800 Serial I/O B Board.

The first five connections to be made are near IC M, towards the top right corner of the board. Make these connections using 1 inch wires. Make each connection by inserting the wire from the silk-screened side of the board and soldering it on the back side. Be sure to clip off any excess lead lengths.

- () Connect the pad labeled NSB according to the following information:
NSB--to--GND = 1 stop bit
NSB--to--+V = 2 stop bits
- () Connect the pads labeled POE and NPB according to the following information:

| <u>NPB</u> | <u>POE</u> | <u>MODE</u> |
|------------|------------|-------------|
| GND | GND | odd parity |
| GND | +V | even parity |
| +V | X | no parity |

(X = don't care)

- () Connect the pads labeled NDB1 and NDB2 according to the following information:

| <u>NDB1</u> | <u>NDB2</u> | <u>data bits/character</u> |
|-------------|-------------|----------------------------|
| GND | GND | 5 |
| +V | GND | 6 |
| GND | +V | 7 |
| +V | +V | 8 |

NOTE: The pad labeled "S0" between IC's Q & R will not be used except with the 88-ACR interface. (see ACR assembly)

There are 6 jumper connections to be made on this board. Make these using 6 inch wires in the same manner as the previous connections with 1 inch wires.

- () Connect pad -V to pad -V
- () Connect pad 0 to pad 0
- () Connect pad I to pad I
- () Connect pad PC to pad PC
- () Connect pad C to pad C
- () Connect pad H to pad H

The connections for the address selection and the BAUD rate selection are made with component leads saved from earlier steps in the assembly procedure. Bend the leads as necessary to fit their respective holes on the board and insert them from the silk-screened side. Solder them on the back side of the board and clip off any excess lead lengths.

For the 88-ACR, wire address select for 006. Wire BAUD Rate for 300 (max.), and wire UART options for 8 data bits, one stop bit, no parity bit.

The jumpers POE, NDB1, NDB2 & NPB should go to +V and NSB should go to GND for 8-bit transmission.

NOTE: In the address selection, wire pads I1 through I7 to A1 and A1 through A7 and A7 as indicated in the chart to obtain the octal address listed in the left column.

Refer to the Theory of Operation manual for further explanations of these two functions.

SERIAL I/O BOARD ASSEMBLY MANUAL ERRATA

THE FOLLOWING INFORMATION IS IN REFERENCE TO THE "HARDWIRE CONNECTIONS" SECTION OF THE I/O MANUAL (Page 12 in the SIO A & C, Page 10 in the SIO B).

THERE ARE FIVE PADS TO BE OPTIONALLY CONNECTED TO EITHER GROUND OR +V. THE DESIGNATIONS PRINTED ON THE BOARD, POE, NDB1, NDB2, NSB AND NPB, REFER TO THE ENTIRE HORIZONTAL GROUP OF THREE PADS TO THE RIGHT OF IC M. THE PADS CLOSEST TO IC M ARE THE ONES TO BE CONNECTED TO EITHER THE SECOND VERTICAL GROUP OF FIVE PADS (GND) OR THE THIRD VERTICAL GROUP OF FIVE PADS (+V). THE POE, NDB1, NDB2, NSB AND NPB PADS THEMSELVES ARE THE FIVE PADS RUNNING VERTICALLY DIRECTLY NEXT TO IC M.

Vectored Interrupt

This is an optional function on the 8800 system, and need not be used at all. If it is to be used, it must be used in conjunction with the 88-VI vectored interrupt card. There is one exception to this which will be explained towards the end of this section.

The 8800 Serial I/O B Board has provisions for vectored interrupt hardware connections. This provides the user with the option of selecting a priority level for the input device and the output device, or a single priority level for both. The vectored interrupt offers 8 levels of priority, 0 through 7, with 7 being the highest priority level.

There are three pads at the top of the board labeled "OUT", "IN" and "BH". There are eight pads at the bottom of the board numbered 0 through 7. The eight numbered pads correspond to the eight priority levels respectively.

Use 6 inch wires to make these connections in the same manner as the previous jumper connections.

You may connect the "OUT" (output device) pad to some priority level, and the "IN" (input device) pad to some priority level; or you may connect the "BH" (both devices) pad to a desired priority level for both devices. If the "BH" pad is used to set the priority level, the "OUT" and "IN" pads should not be used.

() Connect the vectored interrupt priority level as desired per the information above.

It is possible to obtain a single level of interrupt priority on this board without the necessity of the 88-VI vectored interrupt card.

This may be used only on one of the I/O cards in your system, and only one of the three pads ("OUT", "IN" and "BH") can be used to make the connection.

() For a single level of priority interrupt, connect a jumper wire between the pad near the bottom of the board labeled "INT" and the desired pad at the top of the board. Remember only one of the three pads "OUT", "IN" or "BH" may be used and only one I/O board may be connected in this manner.

If the 88-ACR is used with MITS software, interrupts are not used. Do not make any connections to interrupt lines if using MITS software.

Make all hardware connections as described in the instructions.

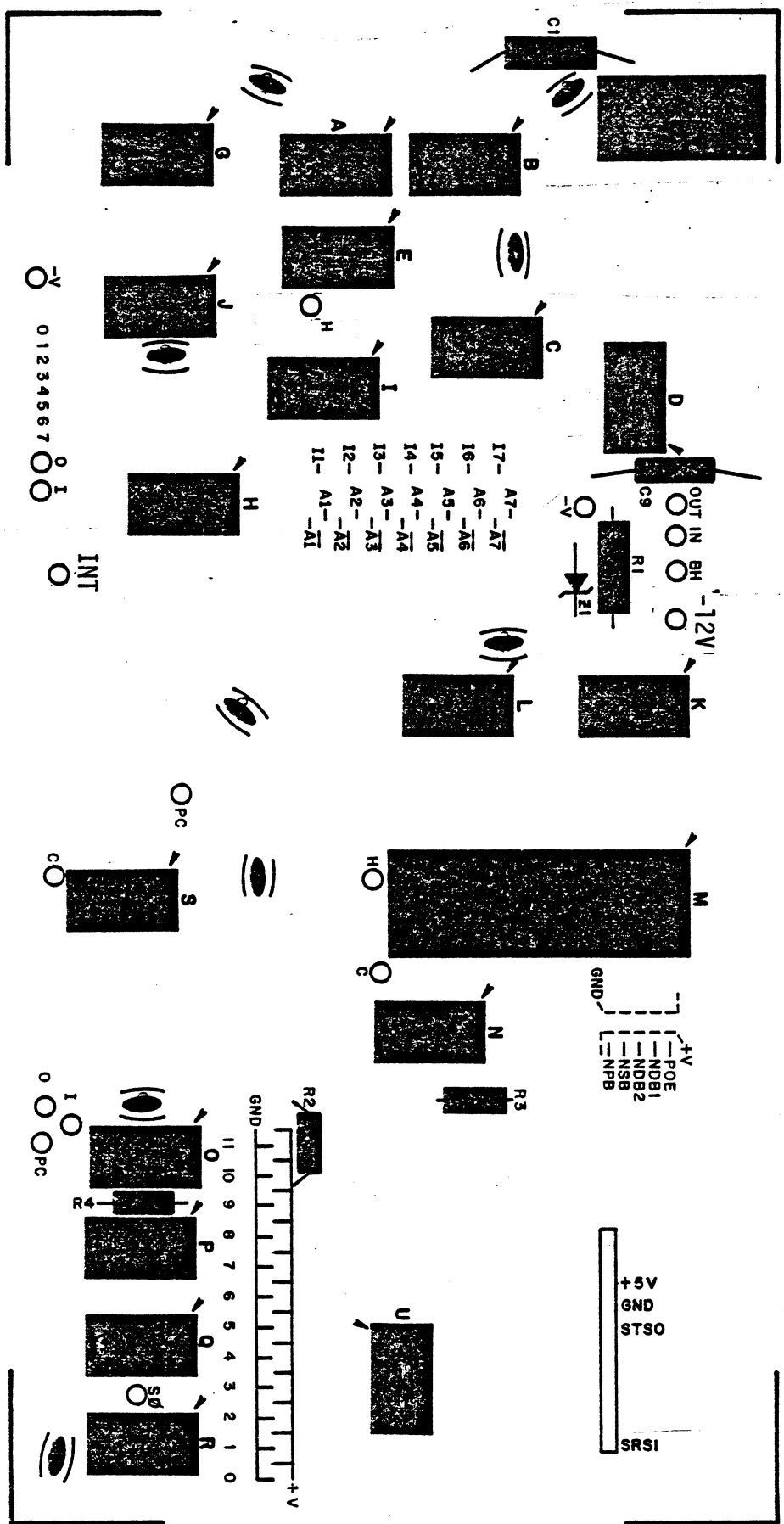

Wafer Connector Installation

There is one 10-pin male connector to be installed on the 8800 Serial I/O B Board.

() Referring to the drawing below, insert the 10-pin wafer connector into the correct holes on the board from the silk-screened side. Be sure to insert the side with the shorter, straight pins.

() Holding the connector in place, turn the board over and solder the 10 pins to the foil pattern on the back side of the board.

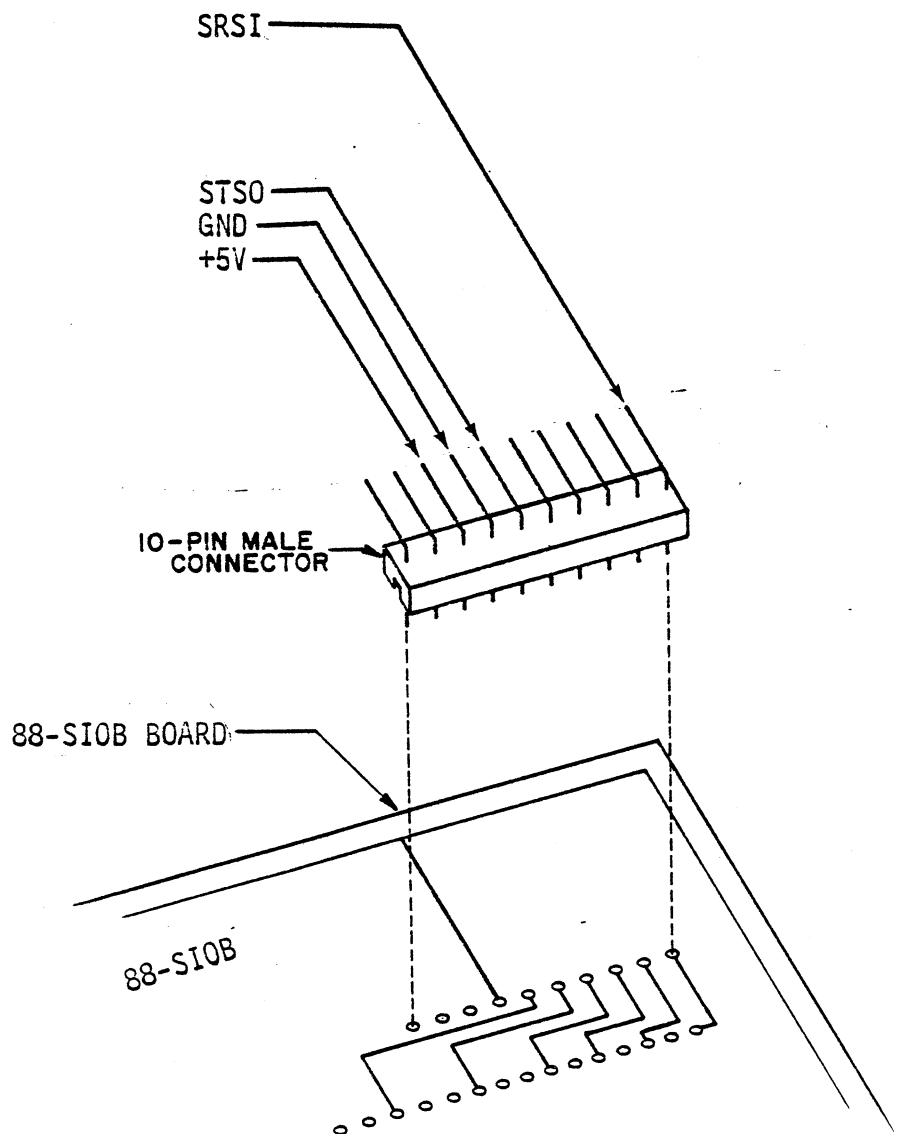

Board Installation

- () IC M may now be installed into its socket on the 8800 Serial I/O B board. Do this very carefully and remember this is a MOS integrated circuit and very sensitive to static electricity.
- () Refer to page 64 in the assembly manual "EXPANDER BOARD 8800 M/BD ASSEMBLY" and install the edge connector provided with the board according to the procedure described there.
- () Press the 8800 Serial I/O B Board into the edge connector just installed. The board should be oriented the same way as the other boards already installed; i.e. the silk-screened side should be facing the right side of the unit viewed from the front panel.

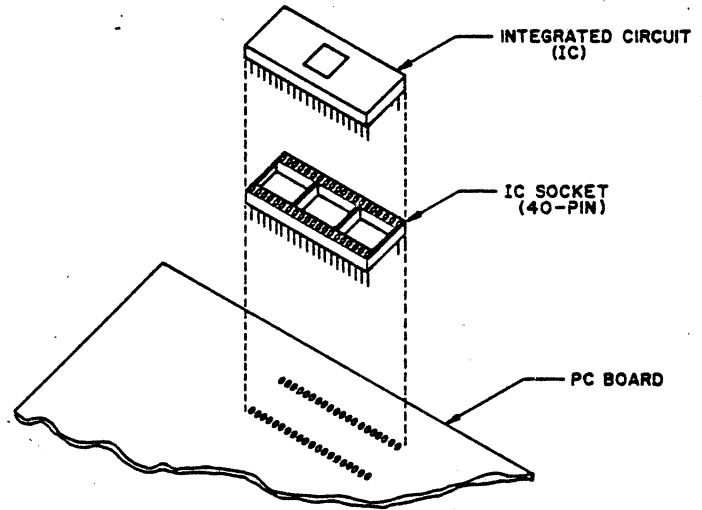

I/O ADDRESS SELECTION CHART

| ADDRESS OCTAL | CONNECTIONS | | | | | | |
|------------------|-----------------|-----------------|-----------------|-----------------|-----------------|-----------------|-----------------|
| | I7 | I6 | I5 | I4 | I3 | I2 | I1 |
| 000 | $\overline{A7}$ | $\overline{A6}$ | $\overline{A5}$ | $\overline{A4}$ | $\overline{A3}$ | $\overline{A2}$ | $\overline{A1}$ |
| 002 | $\overline{A7}$ | $\overline{A6}$ | $\overline{A5}$ | $\overline{A4}$ | $\overline{A3}$ | $\overline{A2}$ | A1 |
| 004 | $\overline{A7}$ | $\overline{A6}$ | $\overline{A5}$ | $\overline{A4}$ | $\overline{A3}$ | A2 | $\overline{A1}$ |
| 006 | $\overline{A7}$ | $\overline{A6}$ | $\overline{A5}$ | $\overline{A4}$ | $\overline{A3}$ | A2 | A1 |
| 010 | $\overline{A7}$ | $\overline{A6}$ | $\overline{A5}$ | $\overline{A4}$ | A3 | $\overline{A2}$ | $\overline{A1}$ |
| 012 | $\overline{A7}$ | $\overline{A6}$ | $\overline{A5}$ | $\overline{A4}$ | A3 | $\overline{A2}$ | A1 |
| 014 | $\overline{A7}$ | $\overline{A6}$ | $\overline{A5}$ | $\overline{A4}$ | A3 | A2 | $\overline{A1}$ |
| 016 | $\overline{A7}$ | $\overline{A6}$ | $\overline{A5}$ | $\overline{A4}$ | A3 | A2 | A1 |
| 020 | $\overline{A7}$ | $\overline{A6}$ | $\overline{A5}$ | A4 | $\overline{A3}$ | $\overline{A2}$ | $\overline{A1}$ |
| 022 | $\overline{A7}$ | $\overline{A6}$ | $\overline{A5}$ | A4 | $\overline{A3}$ | $\overline{A2}$ | A1 |
| 024 | $\overline{A7}$ | $\overline{A6}$ | $\overline{A5}$ | A4 | $\overline{A3}$ | A2 | $\overline{A1}$ |
| 026 | $\overline{A7}$ | $\overline{A6}$ | $\overline{A5}$ | A4 | $\overline{A3}$ | A2 | A1 |
| 030 | $\overline{A7}$ | $\overline{A6}$ | $\overline{A5}$ | A4 | A3 | $\overline{A2}$ | $\overline{A1}$ |
| 032 | $\overline{A7}$ | $\overline{A6}$ | $\overline{A5}$ | A4 | A3 | $\overline{A2}$ | A1 |
| 034 | $\overline{A7}$ | $\overline{A6}$ | $\overline{A5}$ | A4 | A3 | A2 | $\overline{A1}$ |
| 036 | $\overline{A7}$ | $\overline{A6}$ | $\overline{A5}$ | A4 | A3 | A2 | A1 |
| 040 | $\overline{A7}$ | $\overline{A6}$ | A5 | $\overline{A4}$ | $\overline{A3}$ | $\overline{A2}$ | $\overline{A1}$ |
| 042 | $\overline{A7}$ | $\overline{A6}$ | A5 | $\overline{A4}$ | $\overline{A3}$ | $\overline{A2}$ | A1 |
| 044 | $\overline{A7}$ | $\overline{A6}$ | A5 | $\overline{A4}$ | $\overline{A3}$ | A2 | $\overline{A1}$ |
| 046 | $\overline{A7}$ | $\overline{A6}$ | A5 | $\overline{A4}$ | $\overline{A3}$ | A2 | A1 |
| 050 | $\overline{A7}$ | $\overline{A6}$ | A5 | $\overline{A4}$ | A3 | $\overline{A2}$ | $\overline{A1}$ |
| 052 | $\overline{A7}$ | $\overline{A6}$ | A5 | $\overline{A4}$ | A3 | $\overline{A2}$ | A1 |
| 054 | $\overline{A7}$ | $\overline{A6}$ | A5 | $\overline{A4}$ | A3 | A2 | $\overline{A1}$ |
| 056 | $\overline{A7}$ | $\overline{A6}$ | A5 | $\overline{A4}$ | A3 | A2 | A1 |
| 060 | $\overline{A7}$ | $\overline{A6}$ | A5 | A4 | $\overline{A3}$ | $\overline{A2}$ | $\overline{A1}$ |

| ADDRESS OCTAL | CONNECTIONS | | | | | | |
|------------------|-----------------|-----------------|-----------------|-----------------|-----------------|-----------------|-----------------|
| | I7 | I6 | I5 | I4 | I3 | I2 | I1 |
| 062 | $\overline{A7}$ | $\overline{A6}$ | A5 | A4 | $\overline{A3}$ | $\overline{A2}$ | A1 |
| 064 | $\overline{A7}$ | $\overline{A6}$ | A5 | A4 | $\overline{A3}$ | A2 | $\overline{A1}$ |
| 066 | $\overline{A7}$ | $\overline{A6}$ | A5 | A4 | $\overline{A3}$ | A2 | A1 |
| 070 | $\overline{A7}$ | $\overline{A6}$ | A5 | A4 | A3 | $\overline{A2}$ | $\overline{A1}$ |
| 072 | $\overline{A7}$ | $\overline{A6}$ | A5 | A4 | A3 | $\overline{A2}$ | A1 |
| 074 | $\overline{A7}$ | $\overline{A6}$ | A5 | A4 | A3 | A2 | $\overline{A1}$ |
| 076 | $\overline{A7}$ | $\overline{A6}$ | A5 | A4 | A3 | A2 | A1 |
| 100 | $\overline{A7}$ | A6 | $\overline{A5}$ | $\overline{A4}$ | $\overline{A3}$ | $\overline{A2}$ | $\overline{A1}$ |
| 102 | $\overline{A7}$ | A6 | $\overline{A5}$ | $\overline{A4}$ | $\overline{A3}$ | $\overline{A2}$ | A1 |
| 104 | $\overline{A7}$ | A6 | $\overline{A5}$ | $\overline{A4}$ | $\overline{A3}$ | A2 | $\overline{A1}$ |
| 106 | $\overline{A7}$ | A6 | $\overline{A5}$ | $\overline{A4}$ | $\overline{A3}$ | A2 | A1 |
| 110 | $\overline{A7}$ | A6 | $\overline{A5}$ | $\overline{A4}$ | A3 | $\overline{A2}$ | $\overline{A1}$ |
| 112 | $\overline{A7}$ | A6 | $\overline{A5}$ | $\overline{A4}$ | A3 | $\overline{A2}$ | A1 |
| 114 | $\overline{A7}$ | A6 | $\overline{A5}$ | $\overline{A4}$ | A3 | A2 | $\overline{A1}$ |
| 116 | $\overline{A7}$ | A6 | $\overline{A5}$ | $\overline{A4}$ | A3 | A2 | A1 |
| 120 | $\overline{A7}$ | A6 | $\overline{A5}$ | A4 | $\overline{A3}$ | $\overline{A2}$ | $\overline{A1}$ |
| 122 | $\overline{A7}$ | A6 | $\overline{A5}$ | A4 | $\overline{A3}$ | $\overline{A2}$ | A1 |
| 124 | $\overline{A7}$ | A6 | $\overline{A5}$ | A4 | $\overline{A3}$ | A2 | $\overline{A1}$ |
| 126 | $\overline{A7}$ | A6 | $\overline{A5}$ | A4 | $\overline{A3}$ | A2 | A1 |
| 130 | $\overline{A7}$ | A6 | $\overline{A5}$ | A4 | A3 | $\overline{A2}$ | $\overline{A1}$ |
| 132 | $\overline{A7}$ | A6 | $\overline{A5}$ | A4 | A3 | $\overline{A2}$ | A1 |
| 134 | $\overline{A7}$ | A6 | $\overline{A5}$ | A4 | A3 | A2 | $\overline{A1}$ |
| 136 | $\overline{A7}$ | A6 | $\overline{A5}$ | A4 | A3 | A2 | A1 |
| 140 | $\overline{A7}$ | A6 | A5 | $\overline{A4}$ | $\overline{A3}$ | $\overline{A2}$ | $\overline{A1}$ |
| 142 | $\overline{A7}$ | A6 | A5 | $\overline{A4}$ | $\overline{A3}$ | $\overline{A2}$ | A1 |

| ADDRESS OCTAL | CONNECTIONS | | | | | | |
|------------------|-----------------|-----------------|-----------------|-----------------|-----------------|-----------------|-----------------|
| | I7 | I6 | I5 | I4 | I3 | I2 | I1 |
| 144 | $\overline{A7}$ | A6 | A5 | $\overline{A4}$ | $\overline{A3}$ | A2 | $\overline{A1}$ |
| 146 | $\overline{A7}$ | A6 | A5 | $\overline{A4}$ | $\overline{A3}$ | A2 | A1 |
| 150 | $\overline{A7}$ | A6 | A5 | $\overline{A4}$ | A3 | $\overline{A2}$ | $\overline{A1}$ |
| 152 | $\overline{A7}$ | A6 | A5 | $\overline{A4}$ | A3 | $\overline{A2}$ | A1 |
| 154 | $\overline{A7}$ | A6 | A5 | $\overline{A4}$ | A3 | A2 | $\overline{A1}$ |
| 156 | $\overline{A7}$ | A6 | A5 | $\overline{A4}$ | A3 | A2 | A1 |
| 160 | $\overline{A7}$ | A6 | A5 | A4 | $\overline{A3}$ | $\overline{A2}$ | $\overline{A1}$ |
| 162 | $\overline{A7}$ | A6 | A5 | A4 | $\overline{A3}$ | $\overline{A2}$ | A1 |
| 164 | $\overline{A7}$ | A6 | A5 | A4 | $\overline{A3}$ | A2 | $\overline{A1}$ |
| 166 | $\overline{A7}$ | A6 | A5 | A4 | $\overline{A3}$ | A2 | A1 |
| 170 | $\overline{A7}$ | A6 | A5 | A4 | A3 | $\overline{A2}$ | $\overline{A1}$ |
| 172 | $\overline{A7}$ | A6 | A5 | A4 | A3 | $\overline{A2}$ | A1 |
| 174 | $\overline{A7}$ | A6 | A5 | A4 | A3 | A2 | $\overline{A1}$ |
| 176 | $\overline{A7}$ | A6 | A5 | A4 | A3 | A2 | A1 |
| 200 | A7 | $\overline{A6}$ | $\overline{A5}$ | $\overline{A4}$ | $\overline{A3}$ | $\overline{A2}$ | $\overline{A1}$ |
| 202 | A7 | $\overline{A6}$ | $\overline{A5}$ | $\overline{A4}$ | $\overline{A3}$ | $\overline{A2}$ | A1 |
| 204 | A7 | $\overline{A6}$ | $\overline{A5}$ | $\overline{A4}$ | $\overline{A3}$ | A2 | $\overline{A1}$ |
| 206 | A7 | $\overline{A6}$ | $\overline{A5}$ | $\overline{A4}$ | $\overline{A3}$ | A2 | A1 |
| 210 | A7 | $\overline{A6}$ | $\overline{A5}$ | $\overline{A4}$ | A3 | $\overline{A2}$ | $\overline{A1}$ |
| 212 | A7 | $\overline{A6}$ | $\overline{A5}$ | $\overline{A4}$ | A3 | $\overline{A2}$ | A1 |
| 214 | A7 | $\overline{A6}$ | $\overline{A5}$ | $\overline{A4}$ | A3 | A2 | $\overline{A1}$ |
| 216 | A7 | $\overline{A6}$ | $\overline{A5}$ | $\overline{A4}$ | A3 | A2 | A1 |
| 220 | A7 | $\overline{A6}$ | $\overline{A5}$ | A4 | $\overline{A3}$ | $\overline{A2}$ | $\overline{A1}$ |
| 222 | A7 | $\overline{A6}$ | $\overline{A5}$ | A4 | $\overline{A3}$ | $\overline{A2}$ | A1 |
| 224 | A7 | $\overline{A6}$ | $\overline{A5}$ | A4 | $\overline{A3}$ | A2 | $\overline{A1}$ |

| ADDRESS OCTAL | CONNECTIONS | | | | | | |
|------------------|-------------|-----------------|-----------------|-----------------|-----------------|-----------------|-----------------|
| | I7 | I6 | I5 | I4 | I3 | I2 | I1 |
| 226 | A7 | $\overline{A6}$ | $\overline{A5}$ | A4 | $\overline{A3}$ | A2 | A1 |
| 230 | A7 | $\overline{A6}$ | $\overline{A5}$ | A4 | A3 | $\overline{A2}$ | $\overline{A1}$ |
| 232 | A7 | $\overline{A6}$ | $\overline{A5}$ | A4 | A3 | $\overline{A2}$ | A1 |
| 234 | A7 | $\overline{A6}$ | $\overline{A5}$ | A4 | A3 | A2 | $\overline{A1}$ |
| 236 | A7 | $\overline{A6}$ | $\overline{A5}$ | A4 | A3 | A2 | A1 |
| 240 | A7 | $\overline{A6}$ | A5 | $\overline{A4}$ | $\overline{A3}$ | $\overline{A2}$ | $\overline{A1}$ |
| 242 | A7 | $\overline{A6}$ | A5 | $\overline{A4}$ | $\overline{A3}$ | $\overline{A2}$ | A1 |
| 244 | A7 | $\overline{A6}$ | A5 | $\overline{A4}$ | $\overline{A3}$ | A2 | $\overline{A1}$ |
| 246 | A7 | $\overline{A6}$ | A5 | $\overline{A4}$ | $\overline{A3}$ | A2 | A1 |
| 250 | A7 | $\overline{A6}$ | A5 | $\overline{A4}$ | A3 | $\overline{A2}$ | $\overline{A1}$ |
| 252 | A7 | $\overline{A6}$ | A5 | $\overline{A4}$ | A3 | $\overline{A2}$ | A1 |
| 254 | A7 | $\overline{A6}$ | A5 | $\overline{A4}$ | A3 | A2 | $\overline{A1}$ |
| 256 | A7 | $\overline{A6}$ | A5 | $\overline{A4}$ | A3 | A2 | A1 |
| 260 | A7 | $\overline{A6}$ | A5 | A4 | $\overline{A3}$ | $\overline{A2}$ | $\overline{A1}$ |
| 262 | A7 | $\overline{A6}$ | A5 | A4 | $\overline{A3}$ | $\overline{A2}$ | A1 |
| 264 | A7 | $\overline{A6}$ | A5 | A4 | $\overline{A3}$ | A2 | $\overline{A1}$ |
| 266 | A7 | $\overline{A6}$ | A5 | A4 | $\overline{A3}$ | A2 | A1 |
| 270 | A7 | $\overline{A6}$ | A5 | A4 | A3 | $\overline{A2}$ | $\overline{A1}$ |
| 272 | A7 | $\overline{A6}$ | A5 | A4 | A3 | $\overline{A2}$ | A1 |
| 274 | A7 | $\overline{A6}$ | A5 | A4 | A3 | A2 | $\overline{A1}$ |
| 276 | A7 | $\overline{A6}$ | A5 | A4 | A3 | A2 | A1 |
| 300 | A7 | A6 | $\overline{A5}$ | $\overline{A4}$ | $\overline{A3}$ | $\overline{A2}$ | $\overline{A1}$ |
| 302 | A7 | A6 | $\overline{A5}$ | $\overline{A4}$ | $\overline{A3}$ | $\overline{A2}$ | A1 |
| 304 | A7 | A6 | $\overline{A5}$ | $\overline{A4}$ | $\overline{A3}$ | A2 | $\overline{A1}$ |
| 306 | A7 | A6 | $\overline{A5}$ | $\overline{A4}$ | $\overline{A3}$ | A2 | A1 |

| ADDRESS OCTAL | CONNECTIONS | | | | | | |
|------------------|-------------|----|-----------------|-----------------|-----------------|-----------------|-----------------|
| | I7 | I6 | I5 | I4 | I3 | I2 | I1 |
| 310 | A7 | A6 | $\overline{A5}$ | $\overline{A4}$ | $\overline{A3}$ | $\overline{A2}$ | $\overline{A1}$ |
| 312 | A7 | A6 | $\overline{A5}$ | $\overline{A4}$ | A3 | $\overline{A2}$ | A1 |
| 314 | A7 | A6 | $\overline{A5}$ | $\overline{A4}$ | A3 | A2 | $\overline{A1}$ |
| 316 | A7 | A6 | $\overline{A5}$ | $\overline{A4}$ | A3 | A2 | A1 |
| 320 | A7 | A6 | $\overline{A5}$ | A4 | $\overline{A3}$ | $\overline{A2}$ | $\overline{A1}$ |
| 322 | A7 | A6 | $\overline{A5}$ | A4 | $\overline{A3}$ | $\overline{A2}$ | A1 |
| 324 | A7 | A6 | $\overline{A5}$ | A4 | $\overline{A3}$ | A2 | $\overline{A1}$ |
| 326 | A7 | A6 | $\overline{A5}$ | A4 | $\overline{A3}$ | A2 | A1 |
| 330 | A7 | A6 | $\overline{A5}$ | A4 | A3 | $\overline{A2}$ | $\overline{A1}$ |
| 332 | A7 | A6 | $\overline{A5}$ | A4 | A3 | $\overline{A2}$ | A1 |
| 334 | A7 | A6 | $\overline{A5}$ | A4 | A3 | A2 | $\overline{A1}$ |
| 336 | A7 | A6 | $\overline{A5}$ | A4 | A3 | A2 | A1 |
| 340 | A7 | A6 | A5 | $\overline{A4}$ | $\overline{A3}$ | $\overline{A2}$ | $\overline{A1}$ |
| 342 | A7 | A6 | A5 | $\overline{A4}$ | $\overline{A3}$ | $\overline{A2}$ | A1 |
| 344 | A7 | A6 | A5 | $\overline{A4}$ | $\overline{A3}$ | A2 | $\overline{A1}$ |
| 346 | A7 | A6 | A5 | $\overline{A4}$ | $\overline{A3}$ | A2 | A1 |
| 350 | A7 | A6 | A5 | $\overline{A4}$ | A3 | $\overline{A2}$ | $\overline{A1}$ |
| 352 | A7 | A6 | A5 | $\overline{A4}$ | A3 | $\overline{A2}$ | A1 |
| 354 | A7 | A6 | A5 | $\overline{A4}$ | A3 | A2 | $\overline{A1}$ |
| 356 | A7 | A6 | A5 | $\overline{A4}$ | A3 | A2 | A1 |
| 360 | A7 | A6 | A5 | A4 | $\overline{A3}$ | $\overline{A2}$ | $\overline{A1}$ |
| 362 | A7 | A6 | A5 | A4 | $\overline{A3}$ | $\overline{A2}$ | A1 |
| 364 | A7 | A6 | A5 | A4 | $\overline{A3}$ | A2 | $\overline{A1}$ |
| 366 | A7 | A6 | A5 | A4 | $\overline{A3}$ | A2 | A1 |
| 370 | A7 | A6 | A5 | A4 | A3 | $\overline{A2}$ | $\overline{A1}$ |

| ADDRESS OCTAL | CONNECTIONS | | | | | | |
|------------------|-------------|----|----|----|----|-----------------|-----------------|
| | I7 | I6 | I5 | I4 | I3 | I2 | I1 |
| 372 | A7 | A6 | A5 | A4 | A3 | $\overline{A2}$ | A1 |
| 374 | A7 | A6 | A5 | A4 | A3 | A2 | $\overline{A1}$ |
| 376 | A7 | A6 | A5 | A4 | A3 | A2 | A1 |

I/O BAUD RATE SELECTION CHART

In the chart below, PRESET COUNT pads 0 through 11 correspond to pads 0 through 11 on the right side of the I/O board. The BAUD rate listed on the left can be obtained by wiring pads 0 through 11 according to the information in the chart; with "+V" for a 1 and "GND" for a 0.

| BAUD RATE | PRESET COUNT | | | | | | | | | | | |
|-----------|--------------|----|---|---|---|---|---|---|---|---|---|---|
| | 11 | 10 | 9 | 8 | 7 | 6 | 5 | 4 | 3 | 2 | 1 | 0 |
| 110 | 1 | 0 | 1 | 1 | 1 | 0 | 0 | 1 | 0 | 1 | 0 | 0 |
| 150 | 1 | 1 | 0 | 0 | 1 | 1 | 0 | 0 | 0 | 0 | 1 | 1 |
| 300 | 1 | 1 | 1 | 0 | 0 | 1 | 1 | 0 | 0 | 0 | 1 | 1 |
| 600 | 1 | 1 | 1 | 1 | 0 | 0 | 1 | 1 | 0 | 1 | 0 | 0 |
| 1200 | 1 | 1 | 1 | 1 | 1 | 0 | 0 | 1 | 1 | 1 | 0 | 0 |
| 2400 | 1 | 1 | 1 | 1 | 1 | 1 | 0 | 1 | 0 | 0 | 0 | 0 |
| 4800 | 1 | 1 | 1 | 1 | 1 | 1 | 1 | 0 | 1 | 0 | 1 | 0 |
| 9600 | 1 | 1 | 1 | 1 | 1 | 1 | 1 | 1 | 1 | 0 | 0 | 0 |
| 19200 | 1 | 1 | 1 | 1 | 1 | 1 | 1 | 1 | 1 | 1 | 1 | 0 |

88-ACR
MODEM BOARD
ASSEMBLY PROCEDURE



IC and Socket Installation

There are 8 ICs and one 16-pin socket for IC "C" to be installed on the 88-ACR Modem board.

Install the socket according to the following procedure.

- () Be certain that the socket pins are straight. If any of the pins are bent, CAREFULLY straighten them with the tip of a small screwdriver.
- () Set the socket into place and secure it with a piece of masking tape.
- () Turn the board over and solder each pin to the foil pattern of the back of the board. Be sure that EACH pin is soldered, and be careful not to leave any solder bridges.
- () Insert IC "C" (XR 210) into the socket. Handle the IC carefully and use as little pressure as possible to secure it in place.

Install ICs A, B, E, G, and H according to the following procedure.

- () Referring to the component layout, remove the IC with the correct part number from its holder. If there are any bent pins, straighten these using needle-nose pliers. Ensure that you choose the IC with the correct part number.
- () Orient the IC so that its notched end corresponds with the notch printed on the board, and pin 1 of the IC corresponds with the arrow-head printed on the board.

NOTE: If the IC does not have a notch on one end, refer to the IC Orientation Chart included in your manual for the identification of Pin 1.

- () When you have the correct orientation, start the pins on one side of the IC into their respective holes on the silk-screened side of the PC board. DO NOT PUSH THE PINS IN ALL THE WAY. If you have difficulty getting the pins into the holes, use the tip of a small screwdriver to guide them.
- () Start the pins on the other side of the IC into their respective holes in the same manner. When all of the pins have been started, set the IC into place by gently rocking it back and forth until it rests as close as possible to the board. Make sure that the IC is perfectly straight and as close to the board as possible; then tape it in place with a piece of masking tape.
- () Turn the board over and solder each pin of the IC to the foil pattern on the back side of the board. Be sure to solder each pin, and be careful not to leave any solder bridges.
- () Turn the board over again and remove the piece of masking tape.

Use the same procedure to install each of the ICs. Be sure that you have the correct part number and the correct orientation as you install each one.

- () IC A is a 741
- () IC B is a 741
- () IC C is an XR 210
and requires a
16-pin socket
- () IC E is a 7493
- () IC G is a 74L02
- () IC H is a 74L20

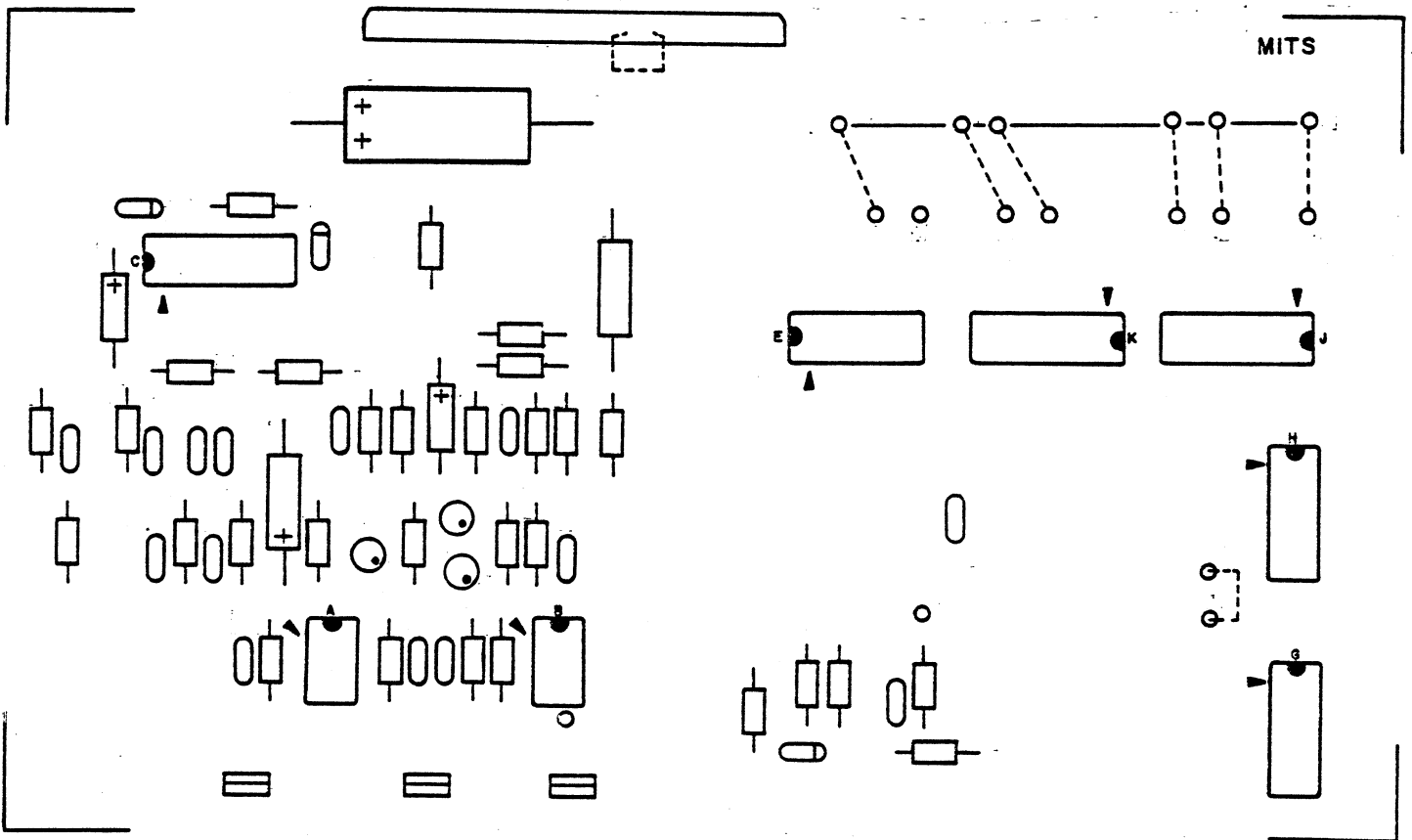

IC Installation Revisions

Due to revisions in the design of the 88-ACR Modem Board, the following ICs require specific instructions.

() J, 93L16

() K, 93L16

J

Install IC "J" according to the preceding general instructions for ICs.

After installation, connect pins 3, 4 and 5 with solder bridges.

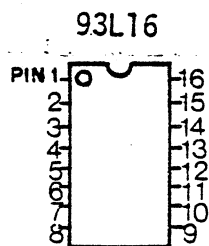

K

Before installing IC "K", carefully bend pins 5 and 6 up, making sure that they do not fit into the holes provided on the printed circuit board.

Install IC "K" according to the preceding general instructions.

Carefully wrap pin 5 to pin 4 of the IC, and solder the connection. Pin 6 will be hardwire-connected later in the assembly procedure.

Resistor Installation

There are 30 resistors to be installed on the 88-ACR Modem Board.

NOTE: Resistors are color-coded according to their value. The resistors in your kit will have four or possibly five bands of color. The fourth band in both cases will be gold or silver, indicating the tolerance. In the following instructions we will be concerned only with the three bands of color to one side of the gold or silver band. Be sure to match these three bands of color with those called for in the instructions as you install each resistor.

Using needle-nose pliers, bend the leads of the resistors at right angles to match their respective holes on the PC board. (see component layout)

NOTE: All resistors on the 88-ACR Modem Board may be either 1/4 or 1/2 Watt.

- () Insert resistor R1 (4.7K-ohm, yellow-violet-red) into the correct holes from the silk-screened side of the PC board. (see component layout)
- () Holding the resistor in place with one hand, turn the board over and bend the two leads slightly outward.
- () Solder the leads to the foil pattern on the back side of the board; then clip off any excess lead lengths.

Referring to the component layout, install the remaining resistors in the same manner. Be sure you have the correct color-coding for each one as you install them.

- () R1, R19, R21, R23, R25 & R33 are 4.7K-ohm, yellow-violet-red
- () R6, R8, R11, R16, R27 & R34 are 10K-ohm, brown-black-orange
- () R7 & R18 are 100K-ohm, brown-black-yellow
- () R10 & R15 are 3.3Meg-ohm, orange-orange-green
- () R12 & R51 are 1.5K-ohm, brown-green-red
- () R14 is 15K-ohm, brown-green-orange
- () R17 is 47K-ohm, yellow-violet-orange
- () R20 & R24 are 2.2K-ohm, red-red-red
- () R22 is 1K-ohm, brown-black-red
- () R26 is 3.3K-ohm, orange-orange-red
- () R28 & Z1 are 3.3K-ohm, orange-orange-red
- () R30 is 100-ohm, brown-black-brown
- () R32 is 8.2K-ohm, gray-red-red
- () R36 & R49 are 470-ohm, yellow-violet-brown
- () R50 is 22K-ohm, red-red-orange

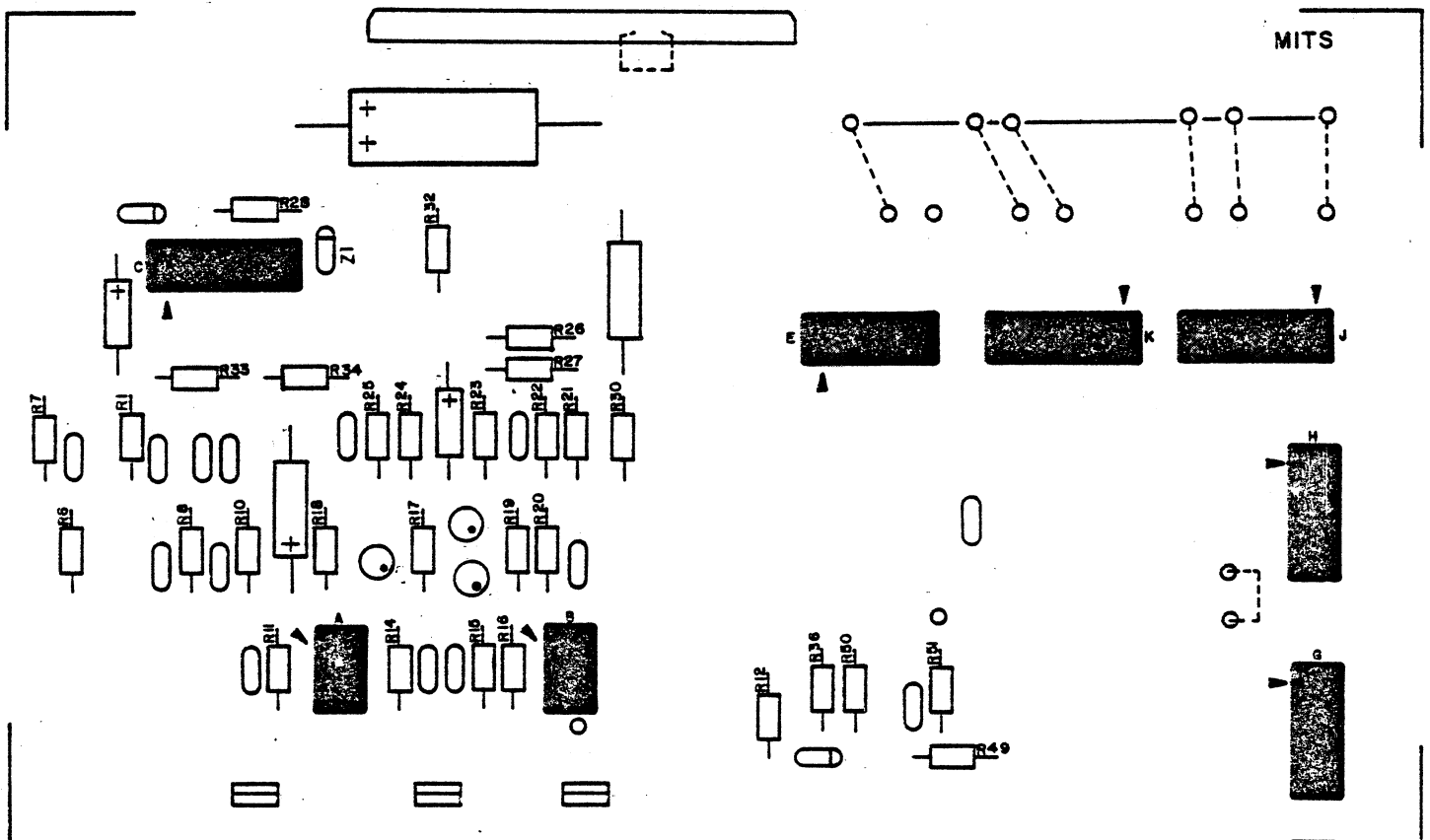

Trim Pot Installation

There are 3 trim pots (variable resistors) to be installed on the 88-ACR Modem Board.

There are two different value pots used on the board; R9 & R13 are 25K-ohms and R29 is 500-ohms. The identification markings on the three pots will be as follows:

R9 & R13 will be marked either "25K" or MTC253L1,
R29 will be marked either "500" or MTC52L1.

- () Insert trim pot R9, 25K-ohms (MTC 253L1), into the correct holes on the back (non-silk-screened) side of the PC board. The pot should mount vertically on the board into the three holes provided with the correct triangular spacing.
- () Turn the board over and solder the three leads to the foil pattern on the back side of the board.

Install trim pots R13 & R29 in the same manner. Be sure you have the correct value pot in the correct location, and check to see that there are no solder bridges.

- () R9 is 25K-ohms, MTC 253L1
- () R13 is 25K-ohms, MTC 253L1
- () R29 is 500-ohms, MTC 52L1

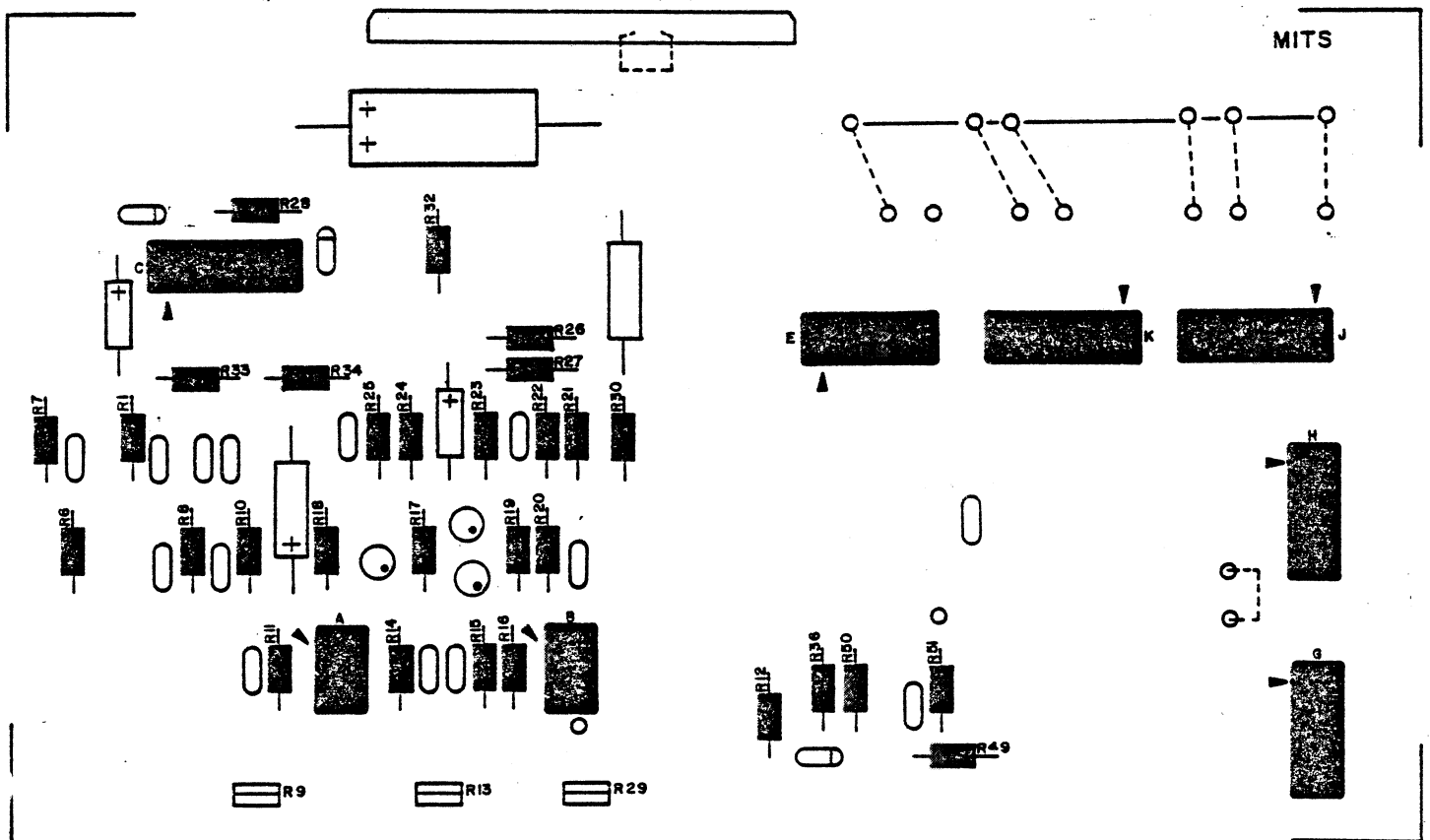

Capacitor Installation

There are 19 capacitors to be installed on the 88-ACR Modem board. Three of these are electrolytic, two are mylar, and the others are ceramic disk capacitors.

Refer to the component layout and install the mylar and ceramic disk capacitors according to the following procedure.

- () Choose the capacitor with the correct value as called for in the instructions. Straighten the two leads as necessary and bend them to fit their respective holes on the PC board.
- () Insert the capacitor into the correct holes from the silk-screened side of the board. Push the capacitor down until the insulation on the leads almost touches the foil pattern.
- () Holding the capacitor in place, turn the board over and bend the two leads slightly outward.
- () Solder the two leads to the foil pattern on the back side of the board; then clip off any excess lead lengths.

Install all of the ceramic disks and the mylar in this manner. Be sure that you have the correct value capacitor as you install each one.

The three electrolytic capacitors for the Modem board have polarity requirements which must be noted before installation. Those contained in your kit may have one or possibly two of three types of polarity markings. To determine the correct orientation, look for the following: (see drawing above right)

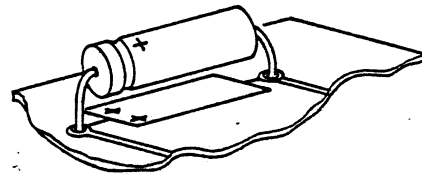

ELECTROLYTIC
CAPACITOR

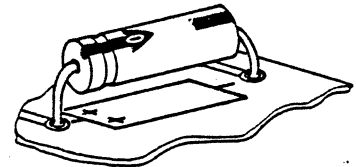

One type will have plus (+) signs on the positive end; another will have a band or a groove around the positive side in addition to the plus signs. The third type will have an arrow on it; in the tip of the arrow there is a negative (-) sign and the capacitor must be oriented so the arrow points to the negative polarity side.

Referring to the component layout, install the electrolytic capacitors onto the board according to the following procedure.

- () Bend the two leads of the capacitor with the correct value at right angles to match their respective holes on the board. Insert the capacitor into the holes from the silk-screened side of the board. Be sure to align the positive polarity side with the "+" signs printed on the board.
- () Holding the capacitor in place, turn the board over and bend the two leads slightly outward. Solder the leads to the foil pattern and clip off any excess lead lengths.

Install all 3 electrolytic capacitors in this manner.

- () C2 is .01 uf
- () C3 is .001 uf
- () C4, C5, C7 & C8 are 470pf
- () C9, C10, C12, C19 & C22 are .1 uf
- () C14 is .15uf mylar
- () C15, C16 & C17 are .033uf
- () C18 is 1uf mylar (Ignore "+" sign on silk screen.
C18 is non-polarized.)
- () C0 is 500uf
- () C11 is 1uf
- () C13 is 35uf

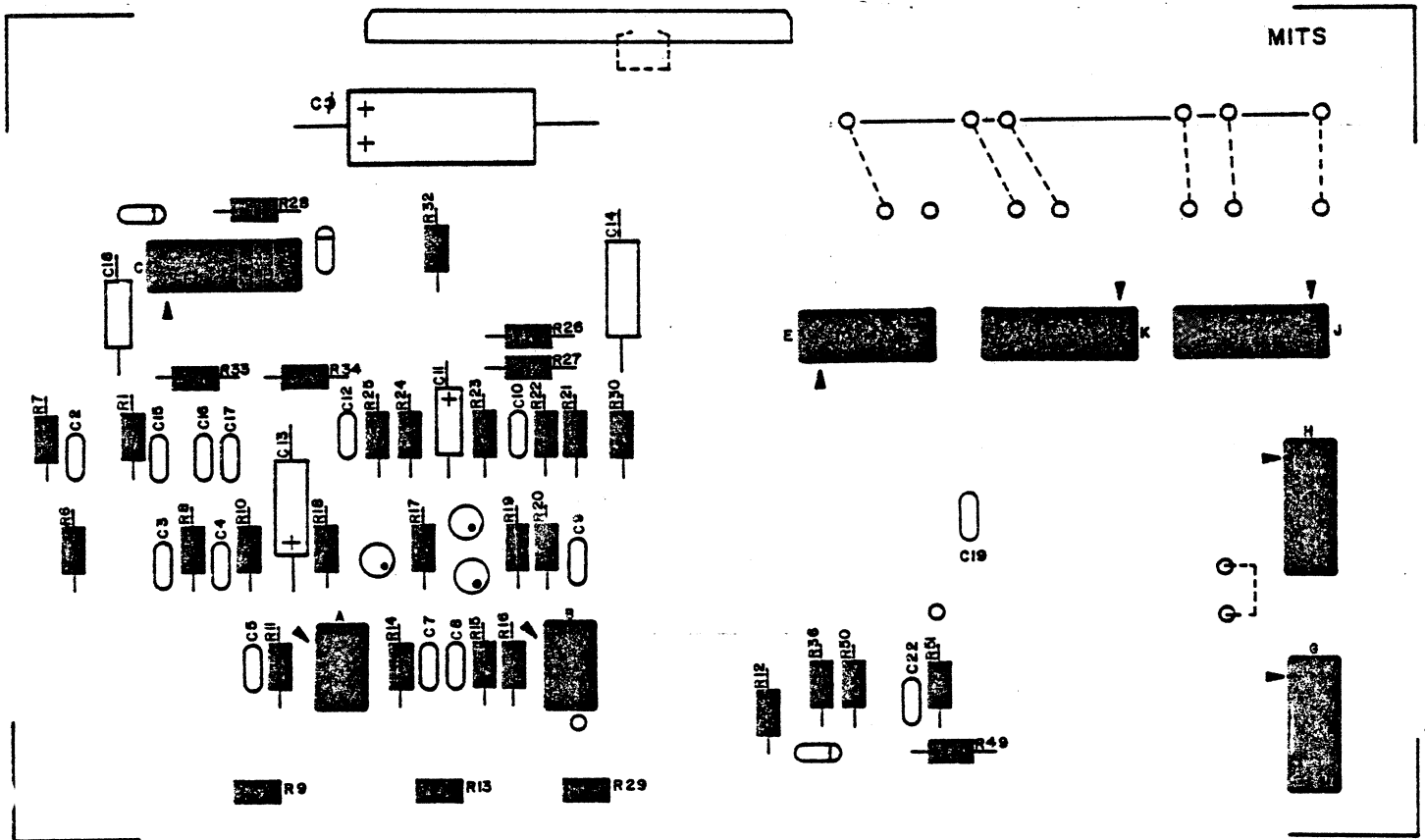

Electrolytic Capacitor
Installation Revisions

Due to revisions in the design of the 88-ACR Modem Board, the following electrolytic capacitors require specific instructions. If you are unfamiliar with the polarity markings for electrolytic capacitors, see the preceding page.

- () C50, 5 mf, electrolytic
- () C51, 500 mf, 25V, electrolytic

Note that C50 and C51 do not appear on the silk screen. The drawings below will help to designate the proper positions for these capacitors.

C50

One lead of C50 will be inserted into the hole next to the designation R30 on the PC Board and soldered to the back of the board for connection. Any remaining lead lengths should be cut off.

The other lead should be cut to a length sufficient to wrap around the lead of R27 once (which is closest to C14). Solder for connection and cut off any remaining length.

Since C50 is an electrolytic capacitor, its polarity markings must be noted. Connect the positive end to R30 and the negative end to R27.

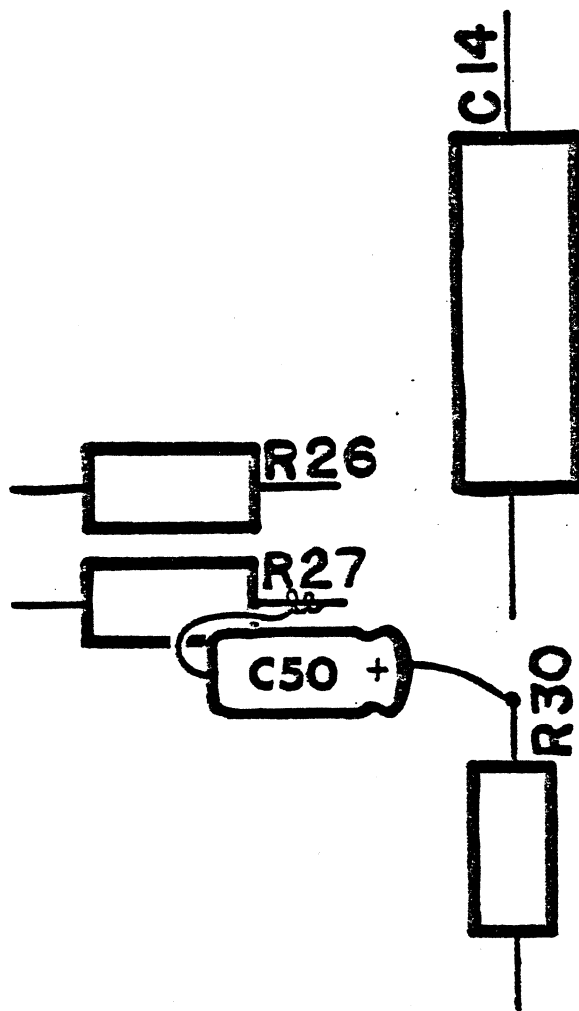

C51

C51 is an electrolytic capacitor (500mf, 25V) which will be positioned below C \emptyset but will be installed on the bottom of the board. (See diagram below)

The positive lead of C51 will be inserted into the hole provided at the end of the track that originates at IC B, pin 7. Insert the lead from the bottom side of the board, solder it to the silk screened side of the board and clip off any excess lead length.

The negative lead should be cut to a length sufficient to wrap around the positive lead of C \emptyset once. Solder the two leads together on the bottom side of the board and clip off any excess lead length.

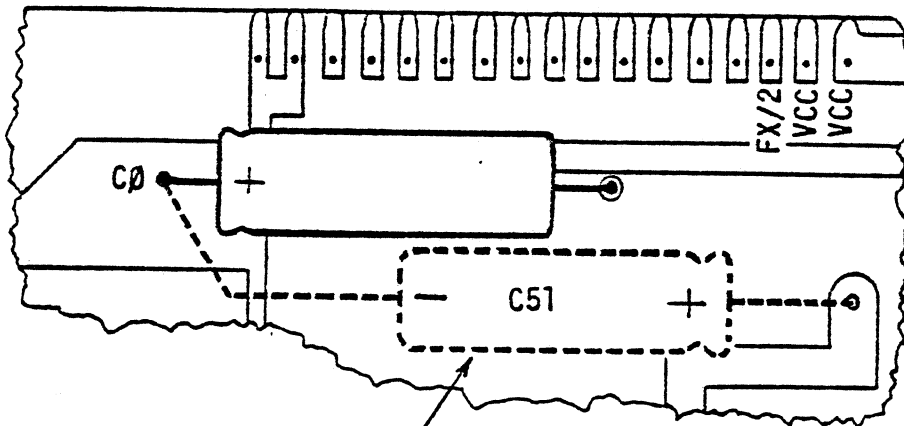

C51 installed on the bottom of the board.

Diode Installation

There is one 1N914 diode to be installed on the 88-ACR Modem board.

NOTE: Diodes are marked with a band on one end indicating the cathode end. The diode must be oriented so that the end with the band is towards the band printed on the board when being installed.

- () Referring to the component layout, bend the leads of 1N914 diode D3 at right angles to match the correct holes on the board.
- () Insert the diode into the correct holes from the silk-screened side of the board. Turn the board over and bend the two leads slightly outward.
- () Solder the two leads to the foil pattern on the back side of the board; then clip off any excess lead lengths.

() D3 is 1N914

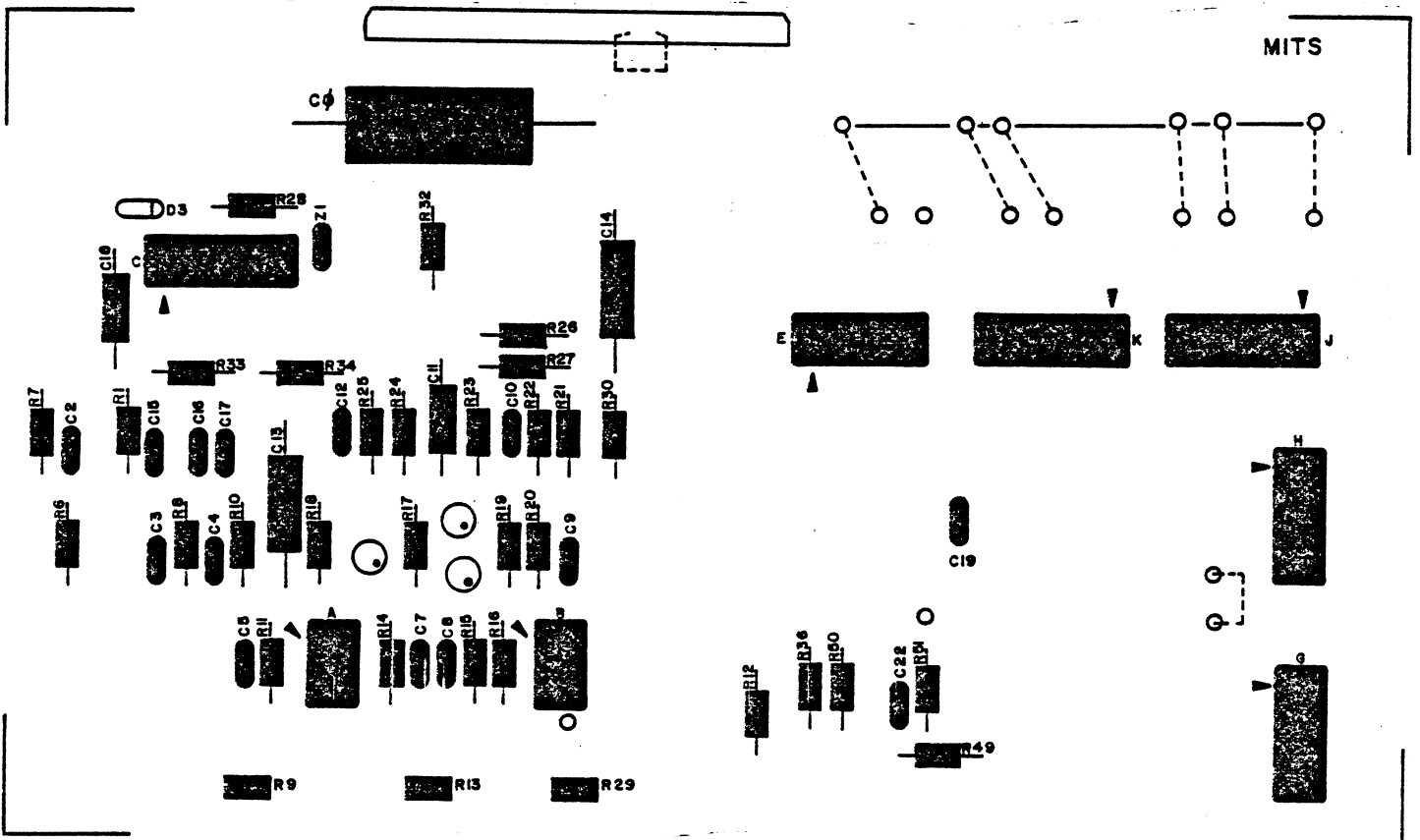

TRANSISTOR IDENTIFICATION CHART

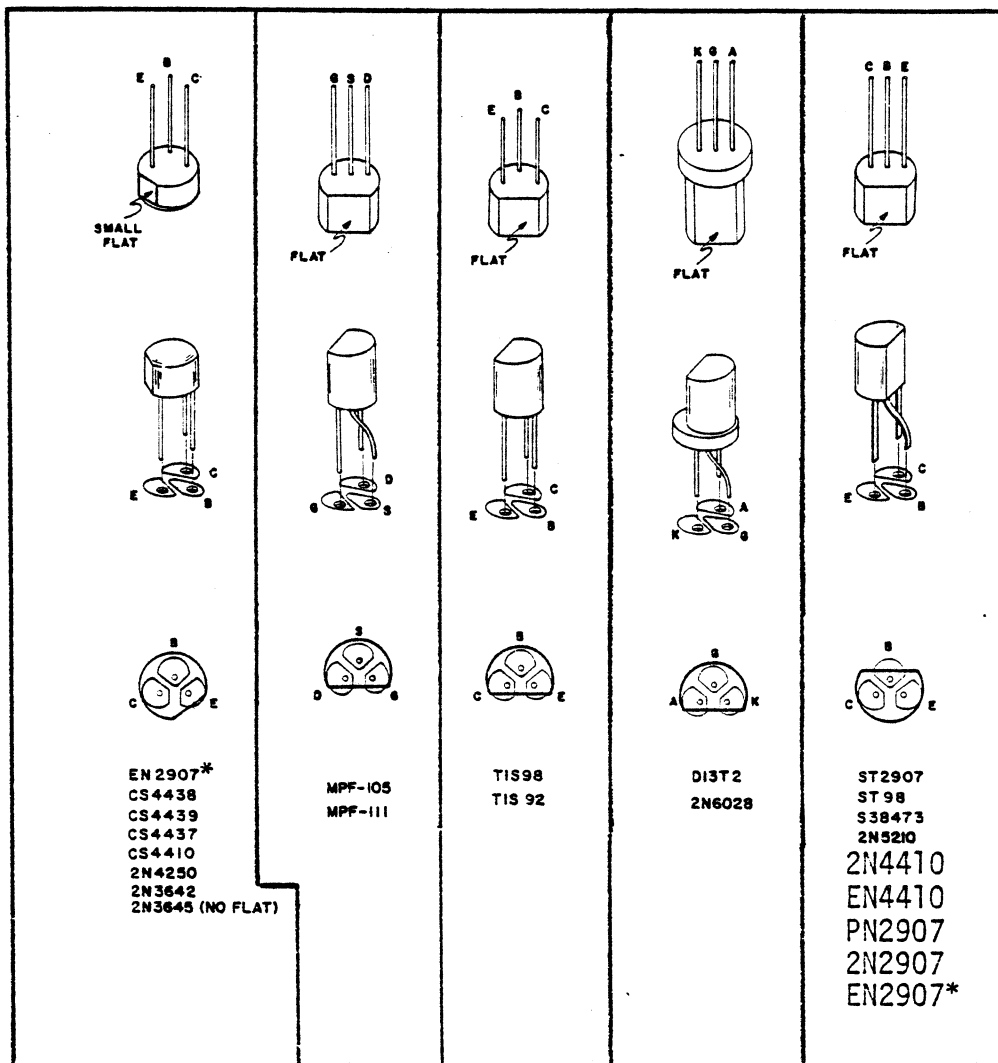

IN THE ILLUSTRATION ABOVE THE OUTLINE OF EACH TYPE OF TRANSISTOR IS SHOWN OVER THE PADS ON THE CIRCUIT BOARD WITH THE CORRECT DESIGNATION FOR EACH OF THE THREE LEADS. USE THIS INFORMATION TOGETHER WITH THE INFORMATION IN THE ASSEMBLY MANUAL FOR THE CORRECT ORIENTATION OF THE TRANSISTORS AS YOU INSTALL THEM.

THE FOLLOWING IS A LIST OF POSSIBLE SUBSTITUTIONS: IF ANY OTHERS ARE USED YOU WILL RISK DAMAGING YOUR UNIT:

2N4410 = EN4410 = CS4410 = CS4437, CS4438, T1S98, ST98, S38473 (NPN)

EN2907 = 2N2907 = PN2907 = ST2907, CS4439 (PNP)

WHEN MAKING SUBSTITUTIONS, REFER TO THE ILLUSTRATION TO DETERMINE THE CORRECT ORIENTATION FOR THE THREE LEADS.

*Configuration of the leads on EN2907 may vary.

Transistor Installation

There are three transistors to be installed on the 88-ACR Modem Board, 1 NPN (CS4410) and 2 PNP (EN2907).

NOTE: When installing these transistors, ensure that you check the part numbers on them before soldering them into place. Some transistors are identical in physical appearance but differ in electrical characteristics. If the part numbers on your transistors do not match the numbers called for in the instructions, it may be that you have substitutions. In this case, refer to the Transistor Identification Chart included with your manual.

- () These transistors are rounded and have a flat edge near one of the leads. The lead nearest this flat edge is called the emitter. The hole for the emitter is the one marked with a dot and the letter "E" on the board. If the emitter lead is placed into this hole, the other two leads should fit into their holes with little or no bending and should not cross over each other. (see drawing below)

- () Orient transistor Q2 (EN2907) so that the lead nearest the flat edge aligns with the correct hole on the board. Insert the transistor into the holes from the silk-screened side of the board.
- () Holding the transistor in place, turn the board over and bend the three leads slightly outward.
- () Solder the leads to the foil pattern on the back side of the board; then clip off any excess lead lengths.

Referring to the component layout, install transistors Q3 & Q4 in the same manner. Be sure that you have the correct part number and the correct orientation for each one as you install them.

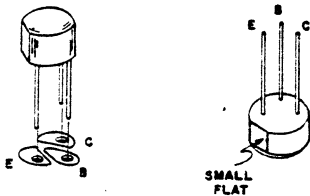

() Q2 is an EN2907

() Q3 is an EN2907

() Q4 is a CS4410

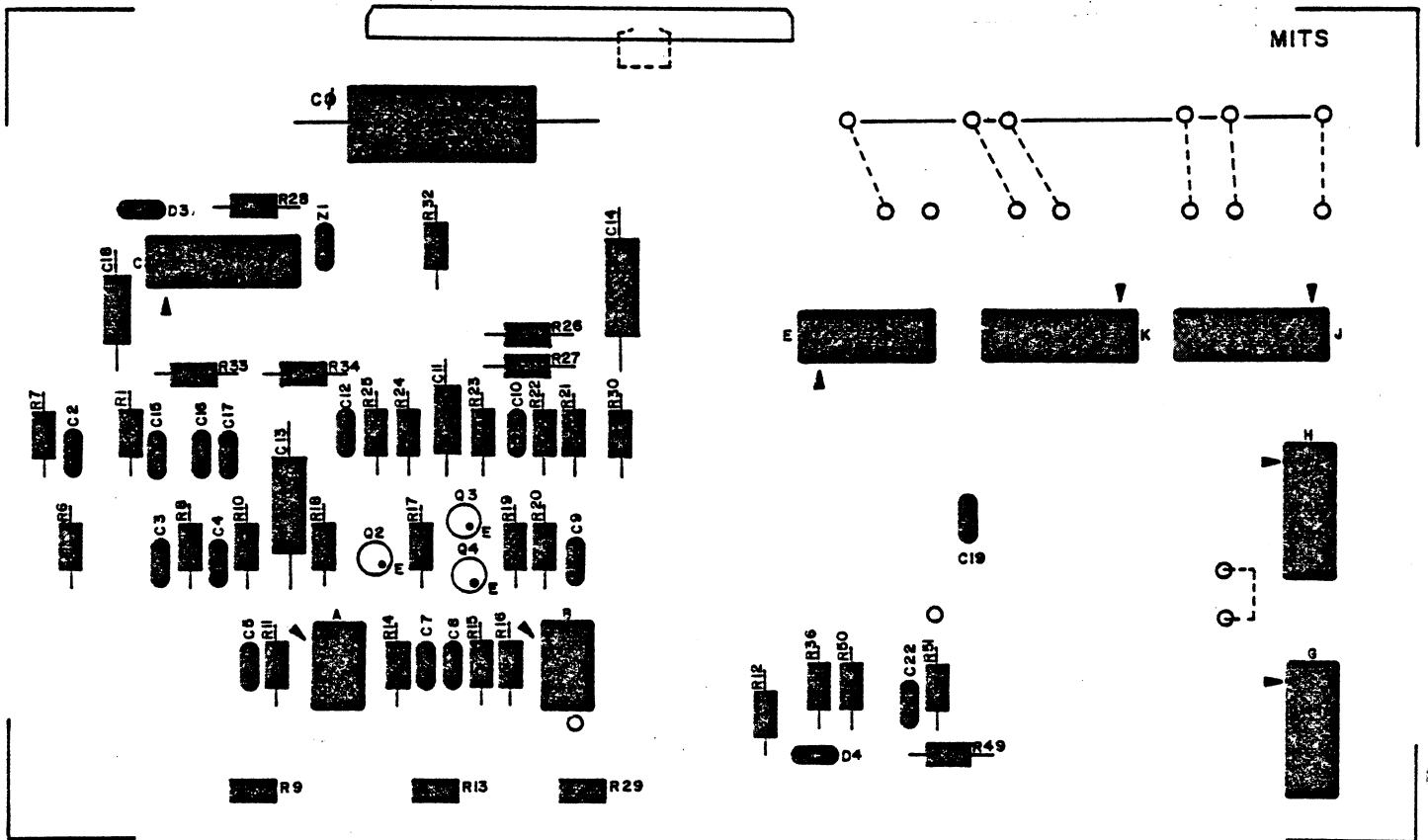

Hardwire Jumper Installation

There are 8 hardwire connections to be made directly on the 88-ACR Modem Board.

These connections are to be made using the 1 1/2 inch wires provided with your kit as follows:

- () Insert the jumper wires one at a time into the correct holes from the silk-screened side of the PC board.

- () Turn the board over and solder each of the leads to the foil pattern on the back side of the board. Clip off the excess wire lengths.

The positions on the board for the jumpers are indicated by two pads with a particular designation and connected by a broken line.
(see component layout)

88-ACR Modem/SIO B Board Interface

There are 10 hardwire jumper connections to be made between the 88-ACR Modem Board and the Serial I/O B (TTL) Board.

Use the 8 inch wires provided with your kit to make all of these connections.

- () Orient the two boards in front of you with the silk-screened sides facing down. The edge connector contacts on the S I/O board should be touching the side of the Modem Board closest to capacitor C0.

The boards may be moved from this position in order to locate the connection points; but, this is the position to maintain the proper spacing for the wires when making the connections. All of the connections should be made from the nonsilk-screened sides of the boards.

Some of these connections will be made to the pins on the S I/O board wafer connector. These pins protrude slightly from the back side of the board and are fairly close together. Exercise great care when making these connections in order to prevent shorts between pins or between pins and PC lands.

Connect the following points on the two boards according to the instructions above:

- () "R0" on the Modem to the leftmost wafer connector pin (Spare) as viewed from the silk-screened side of the S I/O board.
- () "P/R" on the Modem to the second pin on the wafer connector (Spare) of the S I/O board.

- () Connect separate wires to the two pads "GND" on the Modem and join the other ends together to the "GND" pad on the wafer connector of the S I/O board.

NOTE: The board shows three pads labeled GND. The two pads to be used are the second and third pads from the end with the "GND" label.

- () In the same manner connect with 2 wires the pads "Vcc" on the Modem to the "+5V" pin of the connector on the S I/O board.
- () "RS" on the Modem to "SRSI" on the wafer connector of the S I/O board.
- () "XS" on the Modem to "STS0" on the wafer connector of the S I/O board.
- () "FT" on the Modem to "S0" on the S I/O board (pad located between IC's Q & R).
- () "-12V" on the Modem to -12V on the S I/O board. This pad may or may not be marked on the S I/O B board. It is located between C9 and IC K, and connects with the PC land which joins one end of R1 to the anode (non-banded) side of Z1.

Be sure to clip off any excess wire from the connections, and check over all of them on both boards to be sure there are no shorts or solder bridges.

Make all interconnections as per the instructions.

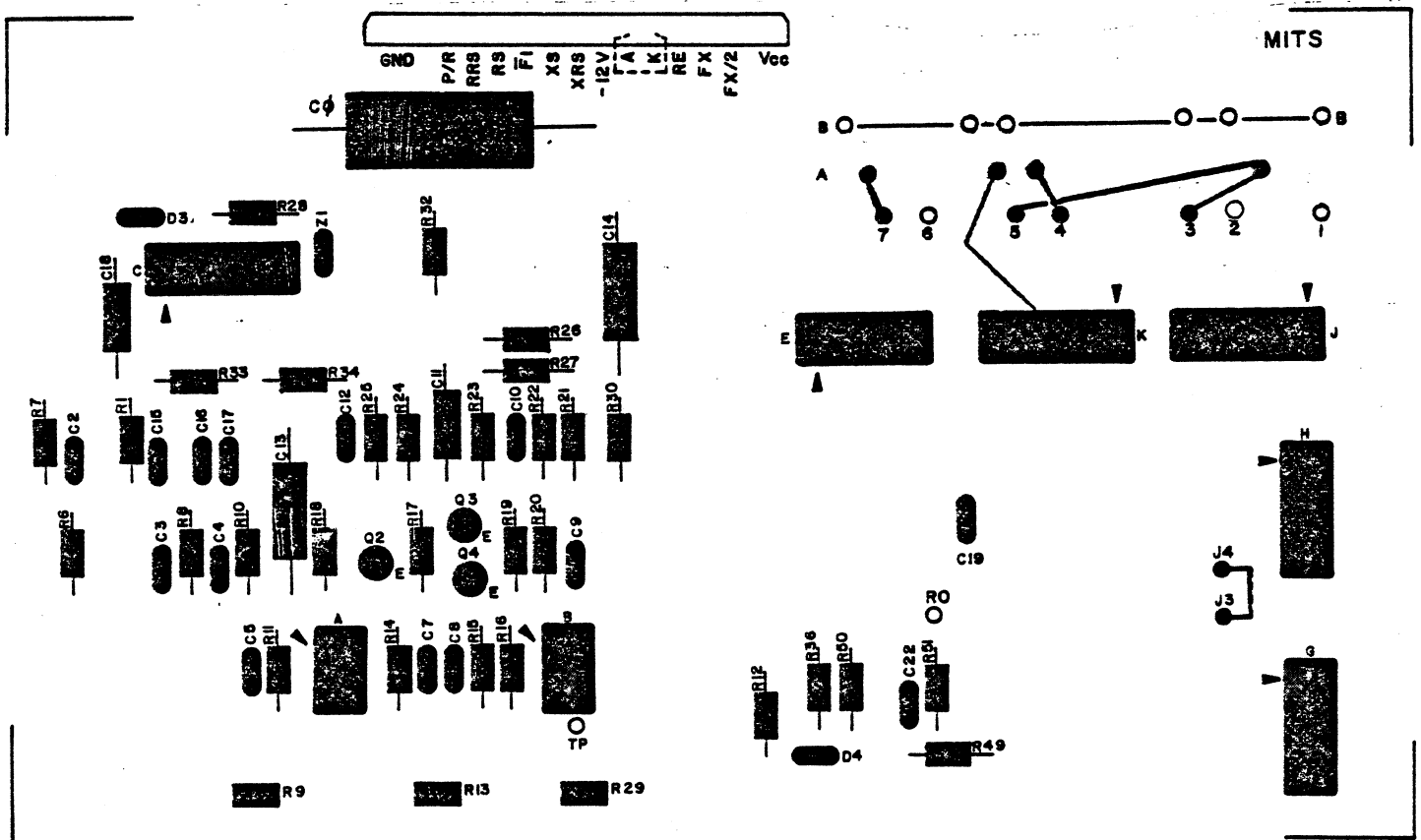

88-ACR Modem/SIO B Board Mating

The 88-ACR Modem Board and the Serial I/O B Board must be mated together before installation to the ALTAIR.

The drawing on the opposite page shows the correct orientation for the two boards to be mated.

- () Before inserting the screws into the SIO/B board, place .15 inch plastic spacers over them.
- () Using the hardware supplied with your kit, mount the two boards together as shown in the drawing.

It is very important that you use the exact orientation shown in the drawing for both the boards and the connecting hardware. Be certain that the back (non-silk-screened) sides of the board face each other.

MATE THE TWO BOARDS AS SHOWN BELOW.

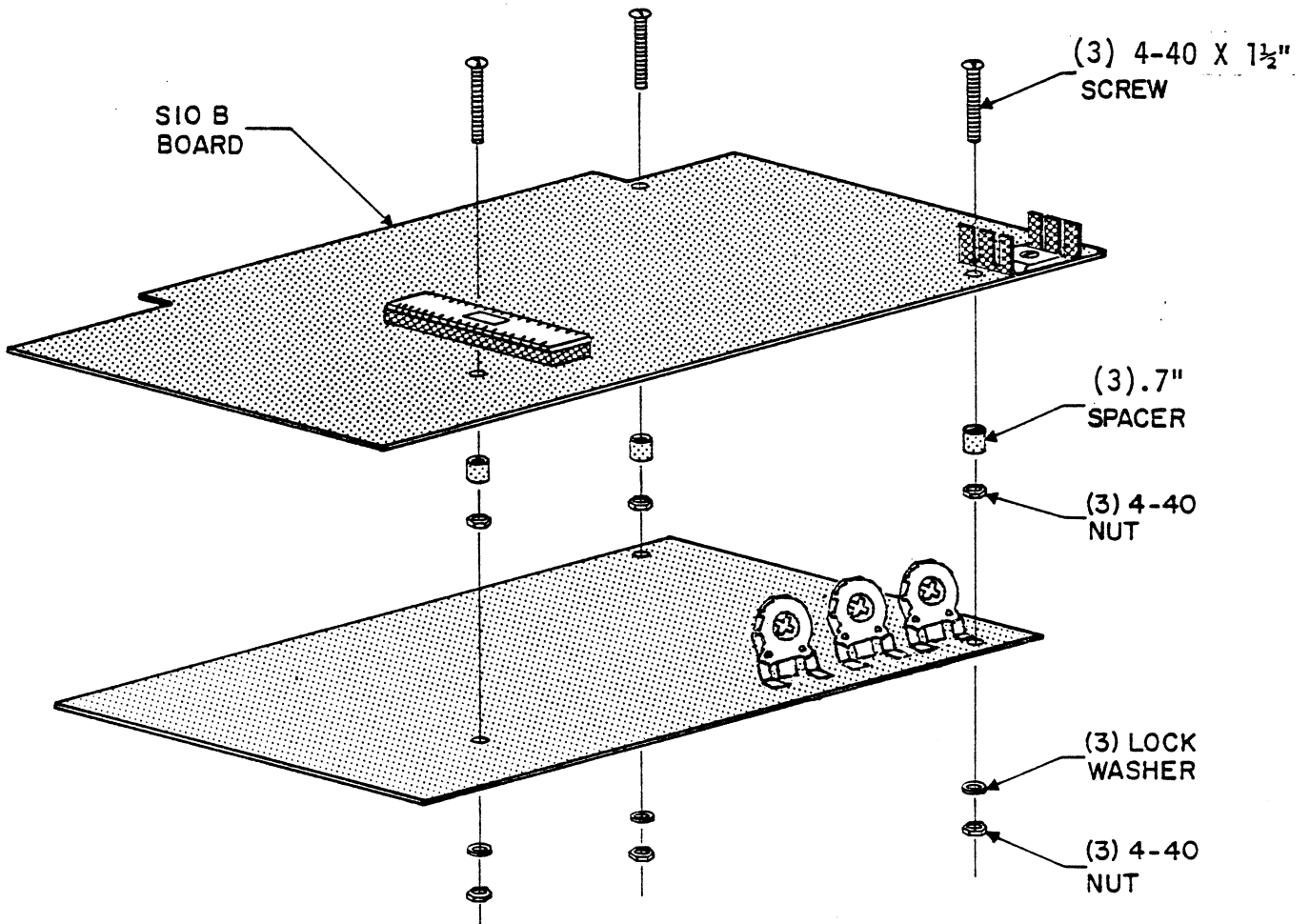

I/O Interface Cable Assembly

There are two 20 inch lengths of shielded cable provided with your kit.

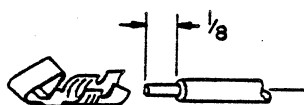

() Using a small sharp knife, strip 1 inch of the outer insulation from both ends of each of the two cables. Do this by cutting a small circle, 1 inch from the end, around the cable and pulling the insulation off. Save the pieces you pull off for later use.

() Separate the shielding from the inner wire, and twist its strands together as tightly as possible on each end.

() Again, using a small sharp knife, strip 1/8 inch of insulation from the ends of the inner wires of both cables.

() Cut 2 pieces of the insulation saved earlier and place them over the shielding wire on one end of the two cables so that only 1/4 inch of bare wire protrudes. Place this end of the two cables together and twist the 2 1/4" sections of shielding into one wire.



() Referring to the drawing on the following page, insert the pins one at a time into the female connector. As you insert each pin, note the color of the wire and label the same wire on the opposite end with the designation indicated by the drawing on the next page. It is very important that you maintain the wire orientation indicated in the drawing.

The pin connected to the two shields goes to "GND". The two pins connected to the two inner wires each go to one of the two "Spare" positions.

This connects the inner wire of one cable to "RO" on the Modem board, and the inner wire of the other to "P/R" on the Modem board.

Attach a connector pin to each of the three wires on the side of the cables where the shields are joined, according to the following instructions.

() Referring to the following drawing install one of the connector pins onto the end of each of the necessary wires. Do this by crimping the wire into place; then soldering the end to the pin itself. The number of wires used will depend on whether pwr. & gnd. are required externally.

() Using a piece of masking tape, label the cable whose inner wire goes to the outside connector pin ("RO") with the words "Record Out" Label the other cable ("P/R") with the words "Play In".

There are two miniature phone jacks also included in your kit.

These jacks each have three solder terminals connected to them. You will observe one of the solder terminals to be connected directly to the center metal portion of the jack which runs through to the mounting threads.

- () Again, cut two pieces of the insulation saved earlier, and place them over the shielding on the two cables so that only 1/8 inch of bare shielding protrudes.
- () Solder the shielding on the two cables to the two jacks on the solder terminal described above.

There are two mechanical contacts on the jacks. One of these is squared, and the other is curved and on the inside position. By observing the jacks from the side, it may be seen that the center of the three solder terminals is connected to the curved contact.

- () Solder the inner wires of the two cables to the solder terminals described above on the two jacks.

Check the connections on both jacks to be sure there are no shorts and that the connections touch no other portion of the jacks but the solder terminals.

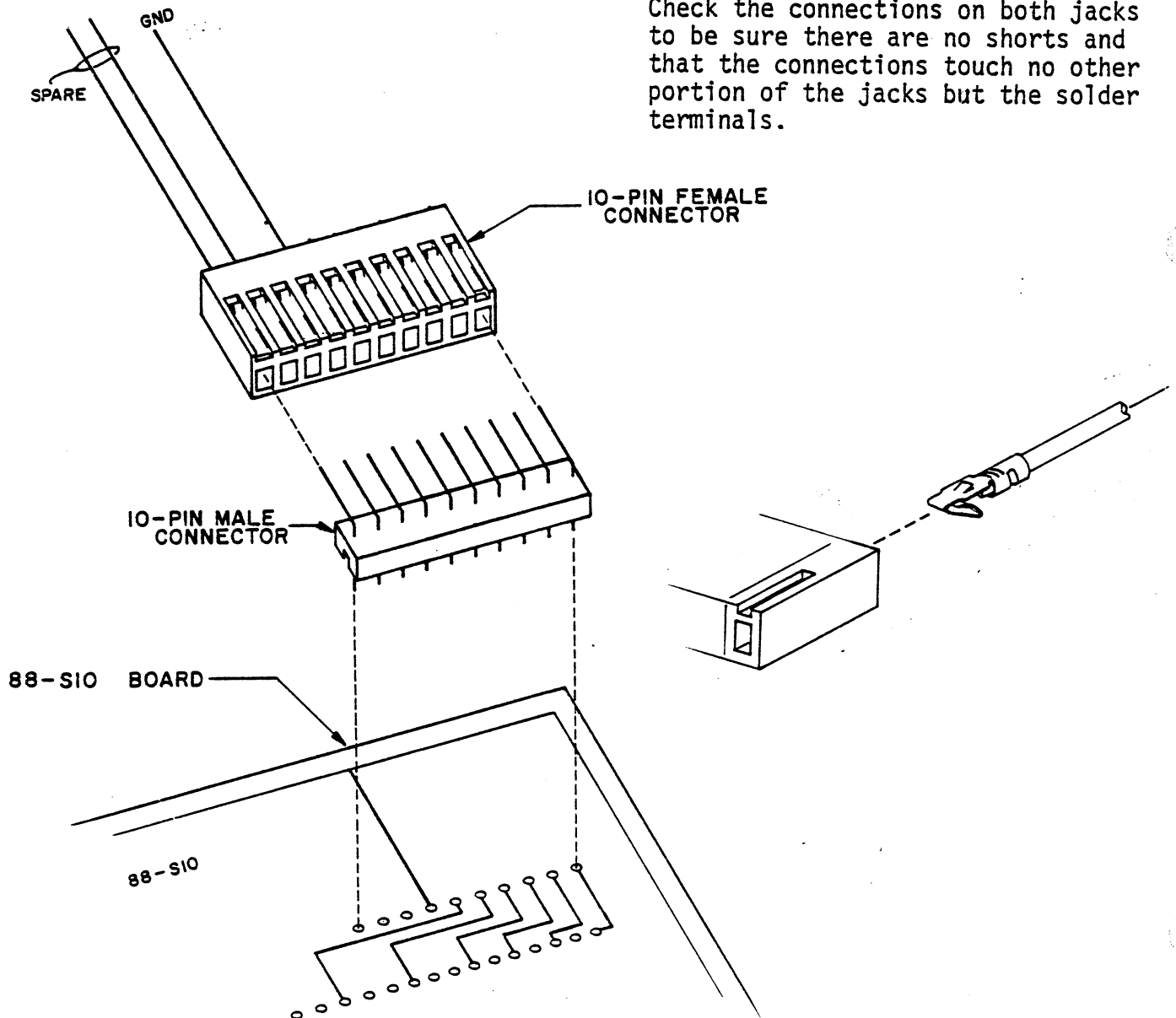

88-ACR & I/O Cable Installation

The two phone jacks can now be mounted onto the ALTAIR back panel.

There are two 1/4 inch holes near the bottom of the ALTAIR back panel, on the side opposite the transformers.

- () Using a piece of rough sandpaper or a small screwdriver blade, scrape the painted area around the two 1/4 inch holes on the inside of the case to expose the bare metal.
- () Remove the mounting hardware from the two phone jacks and place them into the 1/4 inch holes from the inside of the case.
- () Put the mounting hardware back onto the jacks and tighten them into place.

There are two foil labels included with your kit.

- () Remove the backing from the label "TAPE RECORD OUT" and place it over the jack, on the outside of the back panel, connected to the cable labeled "Record Out".
- () Remove the backing from the other label and place it over the other jack in the same manner.
- () Remove the tape labels from the two cables.
- () Attach the female connector on the opposite end of the two cables to the wafer connector on the SIO B board using the orientation described on the preceding page.

The 88-ACR may now be installed into the ALTAIR main case.

The unit should be installed using the edge connector contacts of the SIO B board, with the same general orientation as the other boards in your system. The components on the SIO B board should be facing towards the right side of the ALTAIR as viewed from the front. As this unit consists of two boards, it should be installed in the last slot available on the "mother board" in the system.

88-ACR Alignment Procedure

There are three methods listed for the alignment of the 88-ACR. If an oscilloscope is available, the first method should be used; if only a voltmeter is available, use the second method.

I. Alignment with an Oscilloscope

Read over the section in this manual on Using the 88-ACR; then record the "Output Test Program", listed on page 27, for approximately 15 minutes (one side of a C-30 cassette).

Once this is accomplished, rewind the tape and begin playing it back into the computer. For this purpose, no input program is necessary.

Place the oscilloscope to view the signal at the point labeled "TP" on the Modem board. The scope should be set at approximately 2v/div. vertically and 5ms/div. horizontally.

The point "TP" is the output of the two stage Op Amp filter. Reduce the volume on the recorder as necessary to give an unclipped output at this point.

Using an insulated alignment tool or insulated screwdriver, adjust the two trim pots located closest to the front panel (R9 & R13). Set them to give the maximum smooth output at "TP". It may be necessary to reduce the volume on the recorder during adjustment to prevent clipping of the signal.

If necessary rewind the tape and begin the program over. Set the tone and the volume controls of the recorder at maximum.

Set the oscilloscope to view the signal at "SRSI" on the connector on the SIO B board. Adjust the scope as necessary to view the following.

Trim pot R29 (closest to back panel) should now be adjusted for a +5 volt peak-to-peak square wave.

The signal should be symmetrical, high period = low period; and at a 300 BAUD setting it will be approximately 3.3ms per period (bit).

II. Alignment with Voltmeter

To align your 88-ACR, you may use an easy and accurate method utilizing a voltmeter. The principle being applied is that a D.C. voltmeter reads average voltage, and if you are measuring a square wave, you will read half the peak to peak voltage.

STEP 1: When the output test program in the 88-ACR manual is run (with or without recorder) the voltage on pin 25 (Transmit Data) of the UART (I.C. "M" of the 88-SIOB) should read about 2.5 volts DC; halfway between Logic 0 (0 volts) and Logic 1 (+5 volts). Note the exact vol-

STEP 2: A--Deposit in memory:

| ADDR | DATA |
|------|-----------------------|
| 000 | 333 Input to ACC |
| 001 | 007 88-ACR Data Addr. |

B--Examine 000
C--Single Step twice

This should allow you to examine data from I/O port #7. Data lights 0-7 will indicate the data being received from the recorder (when properly adjusted). This process may be used to examine data or status information from any I/O board--just change the address number.

STEP 3: Play the tape with the output test program recorded on it. Slowly adjust R29 so that the recorded data (125) shows on the data lights. Now measure pin 20 (receive data) of the UART (I.C. "M" of the 88-SIOB) and carefully adjust R29 to the voltage noted in Step 1, about 2.5 volts DC. This adjusts the demodulator.

STEP 4: To adjust the two filter pots, R9 and R13, play the tape with the output test program recorded on it and measure point "TP" on the modem board (pin 6 of IC "B") with the voltmeter on a low voltage A.C. range (10-15 volts).

The voltage measured with the amplifiers clipping should be about 5 v RMS. Reduce the recorder volume until the voltmeter reads 2 or 3 volts RMS and adjust R9 and R13 for maximum reading. Reduce the volume again, if necessary, to keep the reading below 4 volts RMS. Go back and adjust again to get maximum peak. Note that this is not a critical adjustment. Turn the volume back up to max, and go back and recheck the adjustment in step 3.

This completes alignment of the 88-ACR. If it requires readjustment to play data recorded on another machine, do steps 2 and 3.

The MITS Altair Basic cassette has the test recording on the beginning of the back side. If you are using the Basic cassette, be sure your 88-ACR is wired for 300 Baud and address 6 and 7.

III. Alignment without an Oscilloscope or Voltmeter

Read over the section in this manual on Using the 88-ACR; then record the "Output Test Program", listed on page , for approximately 15 minutes (one side of a C-30 cassette).

The two trim pots closes to the front panel (R9 & R13) should be placed in the center position of their full adjustment travel. These are the trim pots for the Op Amp filter and are not critical. They should be left in this position.

The "Input Test Program", listed on page , should now be loaded into the computer.

Once this is accomplished, begin playing the tape into the computer as described in the section on Using the 88-ACR.

With the system functioning normally, if trim pot R29 is not adjusted properly, address lights A0, A1 & A2 only will be lighted.

Using an insulated alignment tool or insulated screwdriver, slowly adjust R29 back and forth until all of the address lights A0 through A7 light, indicating the Test Word is being received properly.

There will be approximately 1/8 turn of travel where this occurs. Find the end points where the signal is lost and set the pot exactly in the center of this area of travel.

Theory of Operation

88-ACR OPERATION

The 88-ACR consists of an 88-SIO B, Serial TTL level I/O board, with a Modem board mated to it.

The Theory of Operation for the SIO B board is contained in its own documentation section within this manual.

Use the block diagram below for reference while reading the Theory of Operation for the Modem (Modulator-Demodulator) board which follows.

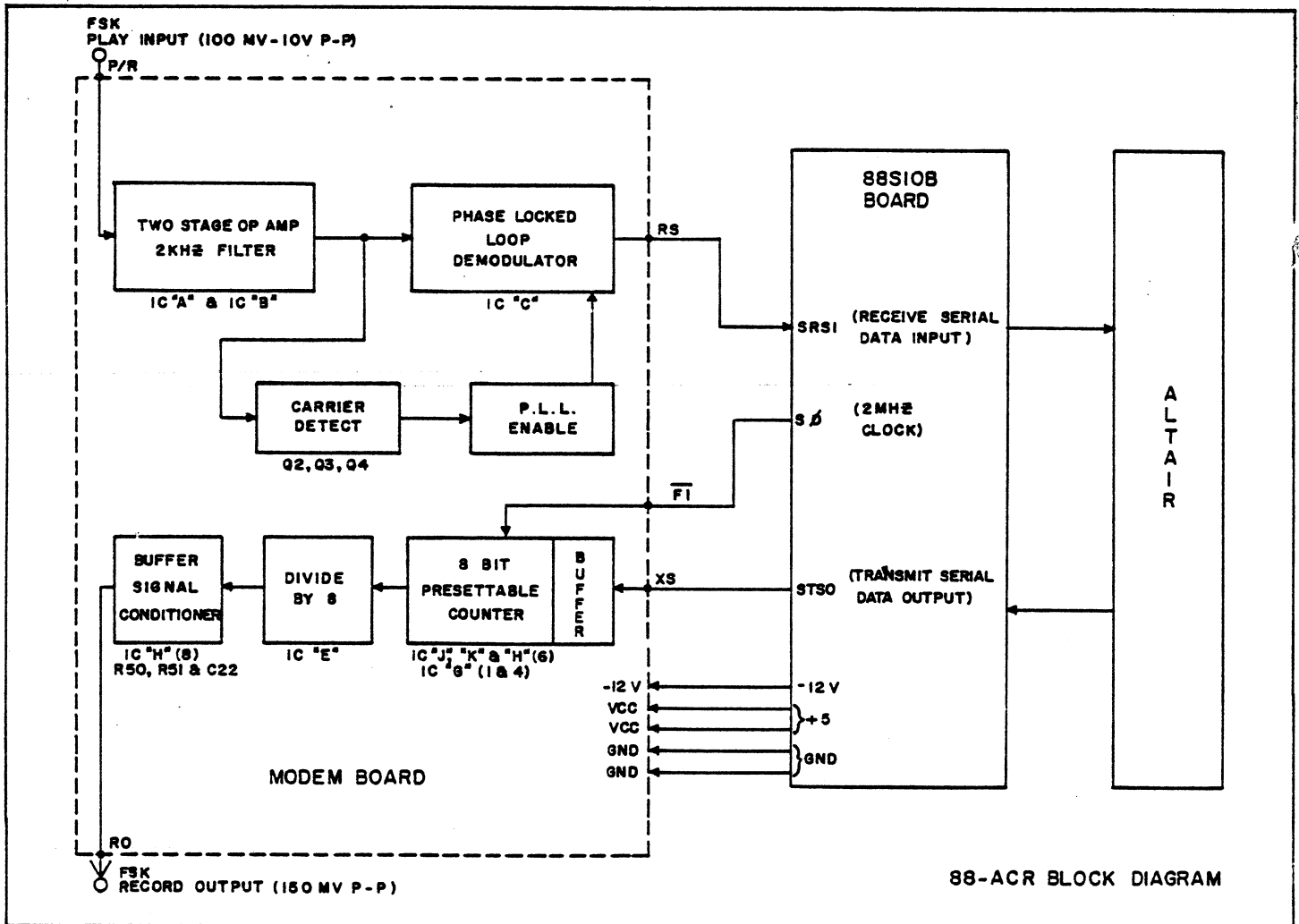

Modulator Operation

When an output program is running, serial data is being outputted on the "STSO" line from the 88-SIO B board. The changing logic levels are presented to the presettable counters, IC's J & K.

The counters (J & K) divide the 2MHz clock by 104 for a logic 1 input, and by 135 for a logic 0 input from the SIO B board. The output of IC K is further divided, by 8, using IC E. The resulting frequencies are 2400 Hz for a logic 1 input, and 1850 Hz for a logic 0 input from the SIO B board.

These signals are fed to the "Buffer Signal Conditioner". Here they are changed from TTL logic level square waves to 100mv peak-to-peak sawtooth waves suitable for the "Mic" inputs of tape recorders.

From the signal conditioner the signal is fed through the SIO B board connector and the shielded cable to the "Tape Record Out" jack on the back of the ALTAIR.

NOTE: "STSO" is normally a logic 1 with no data being outputted(2400 Hz tone at "Tape Record Out").

Demodulator Operation

When playing a tape to load data, the output of the tape recorder is fed into the miniature phone jack labeled "Tape Play In" on the back of the ALTAIR. At this point the audio levels should be between 35mv RMS to 3.5v RMS for proper operation.

This signal is fed by shielded cable through the connector on the SIO B board to the "P/R" connection on the Modem board. The signal is then filtered by IC's A & B and fed into the demodulator, IC C. The output of IC B is also fed to a carrier detector circuit (Q2, Q3 & Q4) that enables IC C.

IC C is a Phase Locked Loop which compares the frequency of the incoming signal with the frequency of its internal oscillator, which is set halfway between 1850 and 2400 Hz. The output of IC C is a corresponding logic 1 for 2400 Hz, or a logic 0 for 1850 Hz on its input.

A zener diode interfaces the output of IC C to TTL logic levels, which are then fed from "RS" on the Modem board to "SRSI" on the SIO B board.

MODEM BOARD VOLTAGE & WAVEFORM TEST DATA







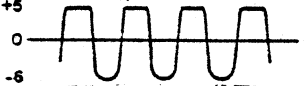

NOTE: All signals and voltages are measured with respect to ground.

The voltage measurements were taken with a 20K ohms/V VOM.

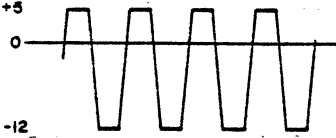
The voltage measurements may vary $\pm 10\%$.

DEMODULATOR SECTION

Measurements on the following test points are given for both no input, and with a 1.5V P-P signal from a tape using the "Output Test Program".

| <u>TEST POINT</u> | <u>NO SIGNAL IN</u> | <u>1.5V P-P SIGNAL IN</u> | |
|--|--------------------------|--|------------------|
| IC A uA741 Invert. Inpt. Pin 2 | 0VDC |  | 0.15V P-P |
| FILTER Non-Invert. Inpt. Pin 3 | 0VDC | 0VDC | |
| Output Pin 6 | 0VDC (may be $\pm .1V$) |  | (2KHz) |
| IC B uA741 FILTER Invert. Inpt. Pin 2 | 0VDC |  | 2V P-P (2KHz) |
| Non-Invert. Inpt. Pin 3 | 0VDC | 0VDC | |
| Output Pin 6 | 0VDC (may be $\pm .1V$) |  | (2KHz) |
| IC C XR-210 (P.L.L.) Volt. Comp. In Pin 1 | -4VDC |  | 1.2V P-P +1VDC |
| Phase Det. Out Pin 2 | -4VDC |  | 2.5V P-P +1VDC |
| Phase Det. Out Pin 3 | -6.25VDC |  | .1V P-P +1.1VDC |
| Phase Det. In Pin 4 | -5.5VDC |  | 2V P-P (2KHz) |
| Phase Det. Bias Pin 5 | -5.5VDC | 0VDC | |
| Phase Det. In Pin 6 | -5.0VDC |  | 1.4V P-P 0VDC |
| V- Pin 7 | -12VDC | -12VDC | |

(cont.)

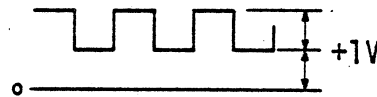
| <u>TEST POINT</u> | | <u>NO SIGNAL IN</u> | <u>1.5V P-P SIGNAL IN</u> |
|------------------------------|--------|---------------------|---|
| Logic Output | Pin 8 | +5VDC |  +5VDC -12VDC (Demodulated data) |
| VCO Fine Tune | Pin 9 | -11.5VDC | -11.5VDC |
| VCO Keying Inpt. (not used) | Pin 10 | -4VDC | -4VDC |
| VCO Gain & Sweep Cntrl. | Pin 11 | -7VDC | -0.25VDC |
| | Pin 12 | -6VDC | -0.5VDC |
| VCO Timing Capacitor | Pin 13 | +3VDC | +3VDC |
| | Pin 14 | +3VDC | +3VDC |
| VCO Output | Pin 15 | |  +1V 2.5V P-P +2.5VDC (2KHz) |
| V+ | Pin 16 | +5VDC | +5VDC |
| Q2 (PNP Silicon EN2907) | E | +5VDC | +5VDC |
| | B | Open | +4.3VDC |
| | C | -7VDC | +4.3VDC |
| Q3 (PNP Silicon EN2907) | E | Open | +4.3VDC |
| | B | +5VDC | +3.6VDC |
| | C | -7VDC | +4.3VDC |
| Q4 (NPN Silicon CS4410/4437) | E | 0VDC | 0VDC |
| | B | 0VDC | +0.7VDC -1.5VDC |
| | C | +3VDC | -6VDC +3VDC (2KHz) 0VDC |

MODULATOR SECTION

Tests are made with no signal on the demodulator input. TTL logic voltage levels are used; logic 0 = -0.5v to +0.8v, logic 1 = +2v to +5.5v. The frequencies are within $\pm 0.05\%$ of the values listed.

| <u>TEST POINT</u> | | <u>MODULATOR INPUT</u> <u>XS = LOGIC 1</u> | <u>MODULATOR INPUT</u> <u>XS = LOGIC 0</u> |
|-------------------|----------------------|---|---|
| IC E | Pin 1 ("B" ff input) | 19200Hz-8 μ s +pulse | 14800Hz-8 μ s +pulse |
| 7493 | Pin 9 ("B" ff out) | 9600Hz-sq. wave | 7400Hz-sq. wave |
| 4-bit ctr. | Pin 11 ("D" ff out) | 4800Hz-sq. wave | 3700Hz-sq. wave |
| | | 2400Hz-sq. wave | 1850Hz-sq. wave |

(cont.)

| <u>TEST POINT</u> | | <u>MODULATOR INPUT</u> <u>XS = LOGIC 1</u> | <u>MODULATOR INPUT</u> <u>XS = LOGIC 0</u> |
|---|---|---|---|
| IC G 7402 Quad 2-Inpt. NOR | Pin 1 Output Pins 2 & 3/4 Inpt./Out. Pins 5 & 6 Input Pin 11 Input Pin 12 Input Pin 13 Output | Logic 1 Logic 0 Logic 1 +.5VDC 2MHz sq. wave 2MHz sq. wave | Logic 0 Logic 1 Logic 0 +.5VDC 2MHz sq. wave 2MHz sq. wave |
| IC H 7420 Dual Quad Inpt. NAND | Pin 1 Input Pin 2 Input Pin 4 Input Pin 5 Input Pin 6 Output Pin 13 Input Pin 12 Input Pin 10 Input Pin 9 Input Pin 8 Output | 19200Hz-8 μ s +pulse 500KHz-sq. wave 250KHz-sq. wave 125KHz-sq. wave 2400Hz-500ns -pulse +5VDC +5VDC 2400Hz-sq. wave 2400Hz-sq. wave 2400Hz-sq. wave | 14800Hz-8 μ s +pulse 500KHz-sq. wave 250KHz-sq. wave 125KHz-sq. wave 1850Hz-500ns -pulse +5VDC +5VDC 1850Hz-sq. wave 1850Hz-sq. wave 1850Hz-sq. wave |
| IC J 9316/74161 Presettable 4-bit ctr. | Pin 2 Clock Inpt. Pin 15 Ripple Carry Out. | 2MHz 125KHz-500ns +pulse | 2MHz 125KHz-500ns +pulse |
| IC K 9316/74161 Presettable 4-bit ctr. | Pin 2 Clock Inpt. Pin 15 Ripple Carry Out. | 2MHz 19200Hz-8 μ s +pulse | 2MHz 14800Hz-8 μ s +pulse |

88-ACR CHECKLIST

If you are encountering difficulties loading basic with the 88-ACR, here is a list of things to try before calling us.

1. After adjusting for 125's on the back of the tape, be sure you can read the 256's on the beginning of the Basic tape. It is possible to adjust the R29 pot on the 88-ACR incorrectly so that you read 125's 180° out of phase. Check for 125's and 256's by depositing 333, then 007, examining the 333 and single step twice. This displays incoming data from the tape on the data lights on the ALTAIR. The 256 pattern should be stable for about 20 seconds before data is received.
2. If an Oscilloscope is available, check the UART clock (pin 40 of IC "M") for a pulse width of about 2.5 microseconds (low going pulse). If the pulse width is less than 2.3 microseconds widen it by adding a 100pf capacitor to C8, if it is larger than 2.8 microseconds, check R4--it should be 7.5K ohms. Also check the repetition rate of the UART clock. For 300 Baud operation the repetition rate should be 208 microseconds (4800HZ = Baud rate X 16).
3. Measure the Zener regulated negative 12 volt supply for the 88-ACR (anode of Z1 on the 88-SIOB board). It should be -12 volts ± 0.8 volts. If it is not right, it will affect the demodulator on the modem board.
4. If you have difficulty with too critical an adjustment for R29 on the modem board, it may be replaced with a 10 or a 20 turn 500 ohm or 1K ohm trim pot.
5. Incorrect tape speed can be checked by measuring the 125 test signal on the back of the basic tape with a frequency counter connected to the audio output of the tape recorder or point "TP" on the modem board. The frequency counter should read 2125 ± 50 HZ for good tape speed. The 88-ACR can accommodate up to ± 100 HZ, but it will require readjustment of R29 on the modem board.
6. To further compensate for tape speed difficulties, try adjusting R29 on the 125 test pattern to yield an offset square wave that is wider on the top than on the bottom and then test your results. If there is no improvement in loading Basic, try the opposite, adjust for slightly wider on the low half of the square wave, and try that. This is to compensate for framing errors in the UART. If the total speed error is greater than $\pm 5\%$, then the UART will not work properly and indicate a framing error.
7. The last way to compensate for framing errors is to change the Baud rate slightly from 275 Baud to 325 Baud and check for framing errors. Since 300 Baud makes each bit 3.33 ms, the demodulated 125 test pattern can be checked with a frequency counter. The correct rate is 150HZ, so you can calculate the percentage and direction of correction necessary.

The best, but usually the most difficult method of correcting speed problems is to adjust your tape recorder speed to match the 2125HZ audio signal of the 125 test pattern. In tape recorders with DC or servo motors it is fairly simple, in A.C. motor machines it is not practical.

Lastly, be sure that the memory you are using is good, the system clock is 2.00MHZ, your cables are connected correctly as indicated, and your tape recorder is away from sources of electrical noise, such as flourescent ligh transformers, etc...

Once you have checked the previous steps where possible, try loading Basic. Deposit the bootstrap loader for cassette, noting the correct code for 4K or 8K Basic, examine 000,000, raise A15 switch, start the tape, wait about 15 seconds, then depress "RUN" on the ALTAIR. About 10 seconds later, the front panel address lights should change to 017647 for 8K Basic, 007647 for 4K Basic and 037647 for Extended Basic (Version 3.2). The status lights should show "MEMR", "INP", "MI", "WO" on full, and "WAIT" dimly lighted. If you get these results, you are in good shape. Basic is now loading, and any errors showing up now will result in a "C" being printed, indicating checksum error (every 256 bytes of data is tested for checksum). Note that Basic loads from the high memory address down. Any problems at this point are most likely being caused by problems in tape speed, wow & flutter, or head alignment. If "M" is printed, there is a memory problem.

88-ACR USER NOTES

Here are more helpful hints for those Altair users having difficulties loading MITS software on cassette tape.

1. Try using lower volume settings on your tape recorder during playback. Sometimes noise generated in recorders playing at maximum volume can cause errors in data. We have found that in most recorders volume settings as low as 1/3 of maximum are satisfactory.
2. If you have trouble obtaining a proper "JUMP" of address lights when beginning a bootstrap load, or you don't want to wait the 15 seconds between starting the tape playing and depressing the run switch, try this 9 step program in addition to the bootstrap loader.

This program tests for the leader bit pattern that is recorded before the checksum loader at the beginning of MITS software. The program will loop at the high addresses until the leader byte is found (10-15 sec. after start of tape) and then jump to the bootstrap loader at 000, 000. Approximately 10 seconds later the address lights change again, indicating proper loading of the software (for version 3.2 A3, A4, & A6 off).

BOOTSTRAP LEADER DETECTOR

| TAG | MNEMONIC | ADDRESS | OCTAL CODE | EXPLANATION |
|-------|----------|---------|---------------|---|
| START | IN | 001,000 | 333 | Input data |
| | | 1 | 007 | From ACR |
| | CPI | 2 | 376 | Compare data byte to (175 for 3.1) (Equal to bootstrap location 1) |
| | | 3 | 256 | Leader byte for version 3.2 |
| | JNZ | 4 | 302 | Jump if data \neq 256 (or 175) |
| | | 5 | 000 | To "START" |
| | | 6 | 001 | |
| | JMP | 7 | 303 | Jump to bootstrap loader |
| | | 001,010 | 000 | If data = 256 (or 175) |
| | | 11 | 000 | |

PROCEDURE

- 1) Load bootstrap loader.
- 2) Load leader detector.
- 3) Examine 001,000
- 4) Start playing tape, depress RUN on Altair.
- 5) After 25 seconds proper jump should occur, and software should load OK.

USING THE 88-ACR

The 88-ACR Audio-Cassette Record Interface is designed to be used with any medium quality or better cassette tape recorder. Music quality recorders generally give better performance than smaller portable recorders.

If a stereo recorder is used, use only left channel if recording and playing tapes used on other tape recorders.

Keep the recorder away from power transformers, fluorescent lamps and other sources of electrical noise when recording or playing back tapes. For maximum performance, use low-noise tape when making all recordings.

Be sure that only the "Play In" or the "Record Out" of the 88-ACR is connected at any one time; never both.

Making a Recording From the 88-ACR

After a program has been loaded into the computer, connect "RECORD OUT" of the 88-ACR to the "Mic" of the recorder.

With the computer in a stopped condition, place the recorder into the record mode. Allow the recorder to run for at least 10 seconds, to allow for sufficient leader, before hitting the "RUN" switch on the computer. If you have a tape counter, start recording at "000" and hit the "RUN" switch at "015" to start recording data. Make note of the start and stop count of the data recorded.

If possible, it may be helpful to monitor the recording by listening with an earphone. This will give you a general indication if the 88-ACR and your program are functioning properly, and the data is actually reaching the recorder.

Most recorders use automatic level record circuits that need no adjustment of volume or tone settings during recording. If your recorder requires setting the record level, use 0 db or maximum undistorted level for recording.

Use this procedure for recording any data on cassette tape.

Loading Data From Tape with the 88-ACR

Before data may be loaded into the computer from a cassette tape, an input program of some type (e.g. 88-ACR Read Program) must first be loaded.

Once the input program is loaded, connect "PLAY IN" of the 88-ACR to the "Speaker", "Earphone" or "Line Out" output of your recorder. The volume and tone controls should be at their maximum settings.

Start playing the tape at the beginning of the leader ("000" if you have a tape counter); then hit the "RUN" switch on the computer before the data starts.

When the data input is complete, as indicated by the tape counter or halting of the input program, the recorder may be stopped.

This procedure should be used any time data is to be loaded from a cassette tape.

OUTPUT TEST PROGRAM

The following is a listing of the output program used to write test data onto tape. This will be used for the alignment of the 88-ACR Demodulator. The program may be used with any memory size, 256 words or larger.

This program will record the test byte (125) until the program is manually stopped. The program is written using I/O address 6 for status and I/O address 7 for data. If your board address has been wired differently, change the program accordingly.

| ADDRESS LOCATION (octal) | OCTAL CODE | MNEMONIC | DESCRIPTION |
|--------------------------------|---------------|----------|--|
| 200 | 333 | IN | Input |
| 201 | 006 | --- | I/O Port Status Address |
| 202 | 007 | RLC | Rotate accumulator left |
| 203 | 332 | JC | Jump if carry |
| 204 | 200 | --- | Lo } Address jumped to if zero Hi } accumulator |
| 205 | 000 | --- | |
| 206 | 076 | MVI | Move immediate to A |
| 207 | 125 | --- | TEST BYTE |
| 210 | 323 | OUT | Output |
| 211 | 007 | --- | I/O Port Data Address |
| 212 | 303 | JMP | Jump unconditional |
| 213 | 200 | --- | Lo } Starting address of routine Hi } |
| 214 | 000 | --- | |

INPUT TEST PROGRAM

The following is a listing of the program for playback of the Output Test Program. This program will also be used for the alignment of the 88-ACR Demodulator. It is written using the same I/O port addresses as the other program stated above, and should be changed accordingly if necessary.

| ADDRESS LOCATION (octal) | OCTAL CODE | MNEMONIC | DESCRIPTION |
|--------------------------------|---------------|----------|---|
| 000 | 333 | IN | Input |
| 001 | 006 | --- | I/O Port Status Address |
| 002 | 017 | RRC | Rotate accumulator right |
| 003 | 332 | JC | Jump if carry |
| 004 | 000 | --- | Lo |
| 005 | 000 | --- | Hi |
| | | | } Address jumped to if zero accumulator |
| 006 | 333 | IN | Input |
| 007 | 007 | --- | I/O Port Data Address |
| 010 | 356 | XRI | Exclusive Or Immediate with A |
| 011 | 125 | --- | Exclusive Or Test Word |
| 012 | 312 | JZ | Jump on zero |
| 013 | 300 | --- | Lo |
| 014 | 000 | --- | Hi |
| | | | } Address jumped to if zero accumulator (Hi Addr. Test Prog.) |
| 015 | 303 | JMP | Jump unconditional |
| 016 | 000 | --- | Lo |
| 017 | 000 | --- | Hi |
| | | | } Address jumped to if zero accumulator |

(cont.)

| ADDRESS LOCATION (octal) | OCTAL CODE | MNEMONIC | DESCRIPTION |
|--------------------------------|---------------|----------|-------------------------------------|
| 300 | 257 | XRA | Exclusive Or register with A |
| 301 | 062 | STA | Store A direct |
| 302 | 376 | --- | Lo |
| 303 | 000 | --- | Hi |
| | | | } First address to be zeroed out |
| 304 | 062 | STA | Store A direct |
| 305 | 377 | --- | Lo |
| 306 | 000 | --- | Hi |
| | | | } Second address to be zeroed out |
| 307 | 072 | LDA | Load A direct |
| 310 | 376 | --- | Lo |
| 311 | 000 | --- | Hi |
| | | | } Address of data for above |
| 312 | 306 | ADI | Add immediate to A |
| 313 | 001 | --- | Data to be added |
| 314 | 062 | STA | Store A direct |
| 315 | 376 | --- | Lo |
| 316 | 000 | --- | Hi |
| | | | } Address for above to be stored |
| 317 | 322 | JNC | Jump on no carry |
| 320 | 337 | --- | Lo |
| 321 | 000 | --- | Hi |
| | | | } Address to be jumped to for above |
| 322 | 072 | LDA | Load A direct |
| 323 | 377 | --- | Lo |
| 324 | 000 | --- | Hi |
| | | | } Address of data for above |

(cont.)

(cont.)

| ADDRESS LOCATION (octal) | OCTAL CODE | MNEMONIC | DESCRIPTION |
|--------------------------|------------|----------|---|
| 325 | 306 | ADI | Add immediate to A |
| 326 | 001 | --- | Data to be added |
| 327 | 062 | STA | Store A direct |
| 330 | 377 | --- | Lo |
| 331 | 000 | --- | Hi |
| | | | } Address for above to be stored |
| 332 | 356 | XRI | Exclusive Or immediate with A |
| 333 | 006 | --- | Data to be Ex-Ored |
| 334 | 312 | JZ | Jump on zero |
| 335 | 000 | --- | Lo |
| 336 | 000 | --- | Hi |
| | | | } Address jumped to if zero accumulator |
| 337 | 333 | IN | Input |
| 340 | 006 | --- | I/O Port Status Address |
| 341 | 017 | RRC | Rotate accumulator right |
| 342 | 332 | JC | Jump if carry |
| 343 | 307 | --- | Lo |
| 344 | 000 | --- | Hi |
| | | | } Address jumped to if zero accumulator |
| 345 | 333 | IN | Input |
| 346 | 007 | --- | I/O Port Data Address |
| 317 | 356 | XRI | Exclusive Or immediate with A |

(cont.)

(cont.)

| ADDRESS LOCATION (octal) | OCTAL CODE | MNEMONIC | DESCRIPTION |
|--------------------------------|---------------|----------|---|
| 350 | 125 | --- | Data to be Ex-Ored (Test Byte) |
| 351 | 312 | JZ | Jump on zero |
| 352 | 300 | --- | Lo- Hi- } Address jumped to if zero accumulator |
| 353 | 000 | --- | |
| 354 | 303 | JMP | Jump unconditional |
| 355 | 000 | --- | Lo- Hi- } Jump to this address if A is not zero |
| 356 | 000 | --- | |

I/O PROGRAMS FOR THE ACR

Write Program, 38 Bytes

Writing data on tape through the 88-ACR is accomplished by first specifying the start address of data and the end address of data. Then a test byte (000 in this program) is written, followed by data output. The last portion of the program tests to see if the program has transmitted the last byte of data. If it has, the program jumps to the last positions in memory, and is observed by a change in the address lights on the front panel. If the program has not outputted the last data byte, the H & L registers are incremented by 1 and the program outputs the next byte. This program is placed in the upper portion of 4K memory with a starting address of 017,000. The location may be changed, but be sure to change all jump addresses accordingly. After recording data that includes program information, write down the start and end address on the tape cartridge along with the name and test byte of the program for identification.

When recording data at the beginning of a cassette tape, record at least 15 seconds of steady tone before running the write program (to get past the plastic leader and wrinkles in the beginning of the tape). Also, if recording more than one batch of data, leave at least 5 seconds of steady tone between batches. This program is written for 88-ACR addresses of 6 & 7.

| TAG | MNEMONIC | ADDRESS | OCTAL CODE | EXPLANATION |
|------|----------|---------|------------|--|
| | LXI | 017,000 | 041 | Load immediate H & L register pair |
| | | 1 | xxx | Lo starting address of |
| | | 2 | | Hi data to be written |
| | LXI | 3 | 001 | Load immediate B & C register pair |
| | | 4 | xxx | Lo end address of |
| | | 5 | xxx | Hi data to be written |
| | MVI | 6 | 076 | Move immediate to accumulator |
| | | 7 | 000 | Test byte to be written at beginning |
| | OUT | 017,010 | 323 | Output data from accumulator |
| | | 11 | 007 | Data channel # of 88-ACR |
| TEST | IN | 12 | 333 | Input data to accumulator |
| | | 13 | 006 | Status channel # of 88-ACR |
| | RLC | 14 | 007 | Rotate accumulator left, test for D7 true |
| | JC | 15 | 332 | Jump if carry (D7 not true) |
| | | 16 | 012 | |
| | | 17 | 017 | To "TEST" |
| | MOV | 017,020 | 176 | Move contents of memory specified |
| | | | | by H & L register to accumulator |
| | OUT | 21 | 323 | Output data from accumulator |
| | | 22 | 007 | Data channel # of 88-ACR |
| | MOV | 23 | 175 | Move contents of L register to accumulator |
| | CMP | 24 | 271 | Compare accumulator vs B register |
| | JNZ | 25 | 302 | Jump if not zero (L≠B) |
| | | 26 | 040 | |
| | | 27 | 017 | To "NEXT" |

| | | | | |
|------|-----|---------|-----|--|
| | MOV | 017,030 | 174 | Move contents of H register to accumulator |
| | CMP | 31 | 270 | Compare accumulator vs C register |
| | JNZ | 32 | 302 | Jump if not zero (H ≠ C) |
| | | 33 | 040 | To "NEXT" |
| | | 34 | 017 | |
| | JMP | 35 | 303 | Jump (if L = B and (H = C) |
| | | 36 | 375 | To "END" |
| | | 37 | 017 | |
| NEXT | INX | 017,040 | 043 | Increment register pair H&L |
| | JMP | 1 | 303 | Jump |
| | | 2 | 012 | To "TEST" |
| | | 3 | 017 | |
| END | JMP | 017,375 | 303 | Jump (loop to self) |
| | | 376 | 375 | To "END" |
| | | 377 | 017 | |

Read Program - 48 Bytes

As in the write program, start and end addresses of incoming data are specified first. Next, the program looks for the test byte (000 in this program). Once the test byte is detected, the program inputs data and stores it in memory as specified by the H & L registers. The next portion of the program tests to see if the end memory address has been filled. If it has, the program jumps to the last positions in memory, and is observed by a change in the address lights on the front panel. If it is not the end, then the program increments H & L by 1 and jumps back to input another data byte. This program is placed in the upper portion of 4K of memory with a starting address of 017,000. The location may be changed, but be sure to change all jump addresses accordingly. When reading data back in, the tape and program should be started a few seconds before the start of data.

| TAG | MNEMONIC | ADDRESS | OCTAL CODE | EXPLANATION |
|-------|----------|---------|------------|---|
| | LXI | 017,000 | 041 | Load immediate H & L register pair |
| | | 1 | xxx | Lo starting address of |
| | | 2 | xxx | Hi data to be read |
| | LXI | 3 | 001 | Load immediate B&C register pair |
| | | 4 | xxx | Lo end address of |
| | | 5 | xxx | Hi data to be read |
| TSTBT | IN | 6 | 333 | Input data to accumulator |
| | | 7 | 006 | Status channel # of 88-ACR |
| | RRC | 017,010 | 017 | Rotate accumulator right (test D0 true) |
| | JC | 11 | 332 | Jump if carry (D0 not true) |
| | | 12 | 006 | To "TSTBT" |
| | | 13 | 017 | |
| | IN | 14 | 000 | Input data to accumulator |
| | | 15 | 007 | Data channel # of 88-ACR |
| | CPI | 16 | 376 | Compare immediate with test byte vs. accumulator |
| | | 17 | 000 | Test byte |
| | JNZ | 017,020 | 302 | Jump if not zero (test byte≠input byte) |
| | | 21 | 006 | To "TSTBT" |
| | | 22 | 017 | |
| TEST | IN | 23 | 333 | Input data to accumulator |
| | | 24 | 006 | Status channel # of 88-ACR |
| | RRC | 25 | 017 | Rotate accumulator right (test D0 true) |
| | JC | 26 | 332 | Jump if carry (D0 not true) |
| | | 27 | 023 | To "TEST" |
| | | 017,030 | 017 | |
| DATA | IN | 31 | 333 | Input data to accumulator |
| | | 32 | 007 | Data channel # of 88-ACR |
| | MOV | 33 | 167 | Move contents of accumulator to memory address specified by H and L registers |
| | MOV | 34 | 175 | Move contents of L register to accumulator |
| | CMP | 35 | 271 | Compare accumulator vs B register |
| | JNZ | 36 | 302 | Jump if not zero (L ≠ B) |
| | | 37 | 051 | To "NEXT" |
| | | 017,040 | 017 | |
| | MOV | 41 | 174 | Move contents of H register to accumulator |
| | CMP | 42 | 270 | Compare accumulator vs C register |
| | JNZ | 43 | 302 | Jump if not zero (H ≠ C) |

| | | | | |
|------|-----|---------|-----|-------------------------------|
| | | 44 | 051 | To "NEXT" |
| | | 45 | 017 | |
| | JMP | 46 | 303 | Jump (if L = B and H = C) |
| | | 47 | 375 | To "END" |
| | | 017,050 | 017 | |
| NEXT | INX | 51 | 043 | Increment H & L register pair |
| | JMP | 52 | 303 | Jump |
| | | 53 | 023 | To "TEST" |
| | | 54 | 017 | |
| END | JMP | 017,375 | 303 | Jump (loop to self) |
| | | 376 | 375 | To "END" |
| | | 377 | 017 | |

Tape Recorder Motor Control

One request for the 88-ACR has been for start/stop motor control for DC motor tape recorders with the sub-miniature phone jack marked "REMOTE". A simple way to do this is to utilize an unused flip-flop normally intended for the interrupt function on the 88-SIOB board. Since the interrupt circuit is usually not used in the 88-ACR mode, it is possible to connect the output of one of the flip-flops to an unused driver of an 8T97 using it as a relay driver.

The circuit shown below uses control channel bit D0 to turn the motor on and off. Consult page of the 88-SIOB manual and the 88-SIOB schematic for detailed information on this circuit.

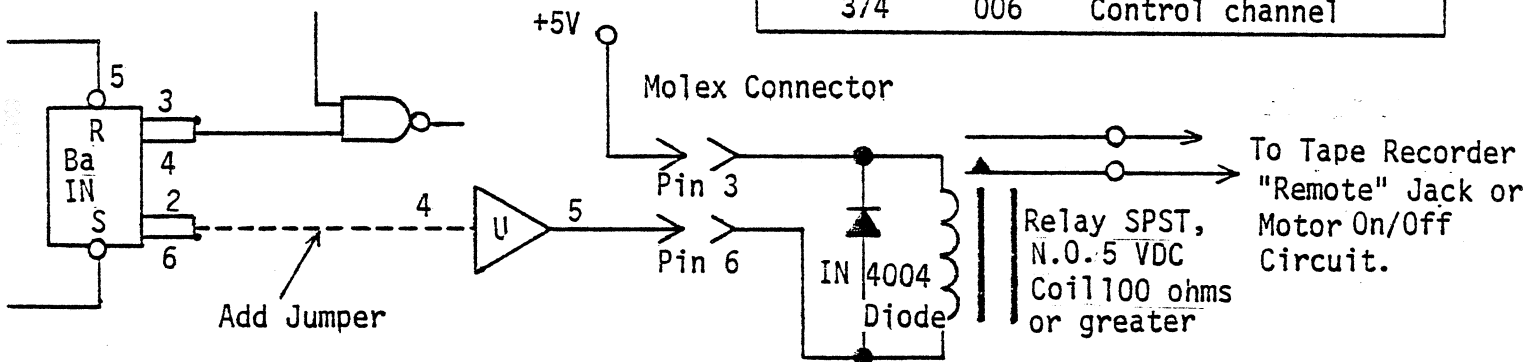

The other half of IC B may be used for another control function in the same manner. IC U has 3 other spare drivers that may be used.

We suggest the relay be mounted externally to prevent recorder supply voltages from interfering with the Altair 8800.

For the machine language Read/Write programs, adding the following instructions will allow use of the start/stop feature.

To turn the motor circuit on, place these instructions before the beginning of the Write and Read programs.

| Location | Octal Code | Mnemonic/Description |
|----------|------------|------------------------------|
| 016,374 | 076 | MVI move immediate to accum. |
| 375 | 001 | Turn on motor |
| 376 | 323 | Output data from accum. |
| 377 | 006 | Control channel |

NOTE: For Write program, single step through these 4 instructions, wait appropriate time (5-15 seconds), then hit RUN.

To turn the motor off, place these instructions before the jump to self loop at "END". Also change data in location 017,376 to 371.

| Location | Octal Code | Mnemonic/Description |
|----------|------------|----------------------|
| 017,371 | 076 | MVI |
| 372 | 000 | Turn motor off |
| 373 | 323 | Output |
| 374 | 006 | Control channel |

NOTE: The flip-flops Ba and Bb do not have power on clear. It may be necessary to single step the motor off circuit to clear these flip-flops.

For use with Altair 8K basic, use:
OUT 6,1 - to turn motor on
CLOAD or CSAVE
OUT 6,0 - to turn motor off

Keep in mind that if writing, you must turn the motor on 5-15 seconds before outputting data.

88-ACR with 88-SIOB
Parts List June 1975

88-ACR

BAG 1

| | | |
|---|-------|--------|
| 2 | uA741 | 101056 |
| 1 | XR210 | 101062 |
| 1 | 74L02 | 101072 |
| 1 | 74L20 | 101039 |
| 1 | 7493 | 101030 |
| 2 | 93L16 | 101093 |

BAG 2

| | | |
|---|-----------------|--------|
| 1 | 100 ohm 1/2w | 101924 |
| 2 | 470 ohm 1/2w | 101927 |
| 1 | 1K ohm 1/2w | 101928 |
| 2 | 1.5K ohm 1/2w | 101946 |
| 2 | 2.2K ohm 1/2w | 101945 |
| 3 | 3.3K ohm 1/2w | 102085 |
| 6 | 4.7K ohm 1/2w | 101930 |
| 1 | 8.2K ohm 1/2w | 102090 |
| 6 | 10K ohm 1/2w | 101932 |
| 1 | 15K ohm 1/2w | 102083 |
| 1 | 47K ohm 1/2w | 101934 |
| 2 | 100K ohm 1/2w | 101936 |
| 2 | 3.3 megohm 1/2w | 102049 |
| 1 | 500 ohm pot | 102025 |
| 2 | 25K ohm pot | 102023 |
| 1 | 22K ohm 1/2w | 101933 |

BAG 3

| | | |
|---|------------------|--------|
| 4 | 470pF 1Kv | 100316 |
| 1 | .001mF 1Kv | 100328 |
| 1 | .01mF 16v | 100305 |
| 3 | .033mF 16v | 100344 |
| 5 | .1mF 10v | 100348 |
| 1 | .15mF 100v | 100345 |
| 1 | 1mF 16v | 100306 |
| 1 | 4.7mF or 5mF 16v | 100309 |
| 1 | 30mF 16v | 100369 |
| 2 | 500mF 25v | 100318 |
| 1 | 1.0 mf, mylar | 100363 |

BAG 4

| | | |
|---|-------------|--------|
| 2 | EN2907 | 102804 |
| 1 | CS4410-4438 | 102808 |
| 1 | 1N914 | 100705 |

BAG 5

| | | |
|----|-----------------------------|--------|
| 8 | 1 1/2" wire | 103002 |
| 10 | 8" red wire | 103041 |
| 2 | 20" shielded audio cable | 103044 |
| 1 | 16-pin Socket | 102103 |

BAG 6

| | | |
|---|--------------------|--------|
| 6 | #4-40 nut | 100932 |
| 3 | #4-40 lockwasher | 100941 |
| 3 | #4-40x1 1/2" screw | 100924 |
| 3 | .15" spacer | 101823 |
| 2 | Mini jacks | 101722 |
| 3 | .7" spacer | 101821 |

MISCELLANEOUS

| | | |
|---|-------------------------------|--------|
| 1 | PC board (modem) | 100170 |
| 1 | Assembly & Operator Manual | 101562 |
| 1 | Foil label set | 101834 |

88-SIOB

BAG 1

| | | |
|---|--------------|--------|
| 1 | MC7805 | 101074 |
| 5 | 74L00 | 101080 |
| 2 | 74L02 | 101072 |
| 2 | 74L04 | 101073 |
| 1 | 74L30 | 101082 |
| 3 | 74L193/93L66 | 101087 |
| 1 | 9601 | 101033 |
| 4 | 74367/8097 | 101040 |
| 1 | COM2502 | 101065 |

BAG 2

| | | |
|---|---------------|--------|
| 1 | 12v zener | 100722 |
| 2 | 2.2K ohm 1/2w | 101945 |
| 1 | 7.5K ohm 1/2w | 101992 |
| 1 | 47 ohm 1/2w | 101922 |

BAG 3

| | | |
|----|----------------|--------|
| 2 | 30mF 10v elec | 100369 |
| 10 | .1mF 10v cer | 100348 |
| 1 | .001mF 10v cer | 100328 |

BAG 4

| | | |
|----|------------------|--------|
| 1 | Connector | 101768 |
| 10 | Terminals | 101769 |
| 1 | Pin (10) | 101812 |
| 1 | 40 pin socket | 102106 |
| 1 | Heatsink (small) | 101870 |

BAG 5

| | | |
|---|-----------------|--------|
| 4 | 6-32x1/2" screw | 100918 |
| 1 | #6 nut | 100933 |
| 1 | #6 lockwasher | 100942 |
| 1 | 6-32x1/4" screw | 100917 |

BAG 6

| | | |
|----|----------------|--------|
| 13 | 6" wire | 103017 |
| 6 | 1 1/2" wire | 103002 |
| 1 | Edge connector | 101864 |
| 2 | Card guides | 101714 |

MISCELLANEOUS

| | | |
|---|----------|--------|
| 1 | PC board | 100132 |
|---|----------|--------|

