

AT27HC641/2

T-46-13-29

Features

- Bipolar Speed  
Read Access Time - 35ns
- Low Power CMOS Operation  
35 mA max. Standby  
75 mA Active at 10 MHz
- Direct Bipolar PROM Replacement
- High Output Drive Capability
- Reprogrammable - 4ms/byte (typical)  
Tested 100% for Programmability
- JEDEC Approved Byte-Wide Pinout  
300 mil, 600 mil, DIP, or LCC packages
- CMOS and TTL Compatible Inputs and Outputs
- High Reliability Latch-Up Resistant CMOS Technology
- Integrated Product Identification Code
- Full Military, Commercial and Industrial Temperature Ranges

64K (8K x 8)  
UV  
Erasable  
CMOS  
PROM

5

Block Diagram

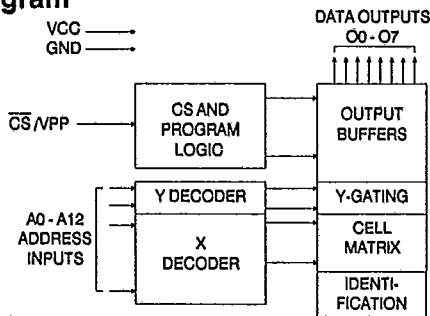

Description

The AT27HC641/642 chip family is a high-speed, low-power 65,536 bit Ultraviolet Erasable and Electrically Programmable Read Only Memory (EPROM) organized 8K x 8. All require only one 5V power supply in normal read mode operation. All bytes on the 641 and 642 parts can be accessed in less than 35ns, making these parts compatible with high performance systems, without penalizing bit density or power consumption.

The 640 series chips come in a choice of JEDEC-approved 24-pin DIPs or 28-pad LCC packages, providing a direct power saving CMOS upgrade for systems originally using Bipolar PROMs. The AT27HC641 is available in standard 600 mil cerdip or plastic (OTP) and LCC packages, while the AT27HC642 provides a space-saving 300 mil cerdip or plastic (OTP) package.

Pin Configurations

Pin Name	Function
A0-A12	Addresses
CS/Vpp	Chip Select/Vpp
O0-O7	Outputs

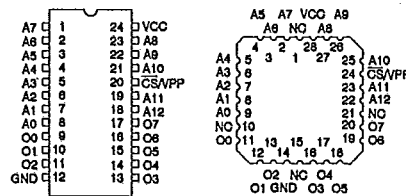



**Description (Continued)**

Atmel's 1.5 micron, high speed CMOS technology provides optimum speed, low-power and high noise immunity. Power consumption on the AT27HC641 and AT27HC642 is typically only 50 mA in Active Mode and less than 20mA in Standby. The high speed CMOS process is an extension of Atmel's high quality and highly manufacturable floating poly EPROM technology. EPROM reprogrammability, which is fully tested before shipment, provides inherently better programmability and reliability than one-time fusible PROMs.

With a storage capacity of 8K bytes, Atmel's 640 series parts allow firmware to be stored reliably and to be accessed at bipolar PROM speeds. All the 640 series parts have exceptional output drive capability - source 4 mA and sink 16 mA per output.

Atmel's 640 series chips also have additional features to ensure high quality and efficient production use. The fast programming algorithm reduces the time required to program the chip and guarantees reliable programming. The Integrated Product Identification Code electronically identifies the device and manufacturing origin. This feature is used by industry standard programming equipment to select the proper programming algorithms and voltages.

**Absolute Maximum Ratings\***

Temperature Under Bias .....	-55°C to +125°C
Storage Temperature .....	-65°C to +150°C
Voltage on Any Pin with Respect to Ground .....	-2.0V to +7.0V <sup>(1)</sup>
Voltage on A9 with Respect to Ground .....	-2.0V to +14.0V <sup>(1)</sup>
$\overline{CS}/V_{PP}$ Supply Voltage with Respect to Ground .....	-2.0V to +14.0V <sup>(1)</sup>
Integrated UV Erase Dose.....	7258 w.sec/cm <sup>2</sup>

\*NOTICE: Stresses beyond those listed under "Absolute Maximum Ratings" may cause permanent damage to the device. This is a stress rating only and functional operation of the device at these or any other conditions beyond those indicated in the operational sections of this specification is not implied. Exposure to absolute maximum rating conditions for extended periods may affect device reliability.

**Notes:**

1. Minimum voltage is -0.6V dc which may undershoot to -2.0V for pulses of less than 20ns. Maximum output pin voltage is  $V_{CC}+0.75V$  dc which may overshoot to +7.0V for pulses of less than 20ns.

ATMEL CORP

29E D

**Erase Characteristics**

The entire memory array of an Atmel 640 series chip is erased (all outputs read as  $V_{OH}$ ) after exposure to ultraviolet light at a wavelength of 2537Å. Complete erasure is assured after a minimum of 20 minutes exposure using 12,000  $\mu W/cm^2$  intensity lamps spaced one inch away from the chip. Minimum erase time for lamps at other intensity ratings can be calculated from the minimum integrated erasure dose of 15W.sec/cm<sup>2</sup>. To prevent unintentional erasure, an opaque label is recommended to cover the clear window on any UV erasable EPROM which will be subjected to continuous fluorescent indoor lighting or sunlight.

**Operating Modes**

MODE \ PIN	$\overline{CS}/V_{PP}$	AI	VCC	Outputs
Read	V <sub>IL</sub>	Ai	V <sub>CC</sub>	DOUT
Standby	V <sub>IH</sub>	X <sup>(1)</sup>	V <sub>CC</sub>	High Z
Fast Program <sup>(2)</sup>	V <sub>PP</sub>	Ai	V <sub>CC</sub>	DIN
PGM Verify	V <sub>IL</sub>	Ai	V <sub>CC</sub>	DOUT
Product Identification <sup>(4)</sup>	V <sub>IL</sub>	A9 = V <sub>IH</sub> <sup>(3)</sup> A0 = V <sub>IH</sub> or V <sub>IL</sub> A1-A12 = V <sub>IL</sub>	V <sub>CC</sub>	Identification Code

1. X can be V<sub>IL</sub> or V<sub>IH</sub>.
2. Refer to Programming characteristics.
3. V<sub>IH</sub> = 12.0 ± 0.5V.

4. Two identifier bytes may be selected. All Ai inputs are held low (V<sub>IL</sub>), except A9 which is set to V<sub>IH</sub> and A0 which is toggled low (V<sub>IL</sub>) to select the Manufacturer's Identification byte and high (V<sub>IH</sub>) to select the Device Code byte.

**AT27HC641/2**

T-46-13-29

**D.C. and A.C. Operating Conditions for Read Operation**

AT27HC641 / AT27HC642						
		-35	-45	-55	-70	-90
Operating Temperature (Case)	Com.	0°C - 70°C	0°C - 70°C	0°C - 70°C	0°C - 70°C	0°C - 70°C
	Ind.		-40°C - 85°C	-40°C - 85°C	-40°C - 85°C	-40°C - 85°C
	Mil.		-55°C - 125°C	-55°C - 125°C	-55°C - 125°C	-55°C - 125°C
VCC Power Supply		5V ± 5%	5V ± 10%	5V ± 10%	5V ± 10%	5V ± 10%

**D.C. and Operating Characteristics for Read Operation**

Symbol	Parameter	Condition	Min	Max	Units
I <sub>LI</sub>	Input Load Current	V <sub>IN</sub> = -0.1V to V <sub>CC</sub> + 1V		10	μA
I <sub>LO</sub>	Output Leakage Current	V <sub>OUT</sub> = -0.1V to V <sub>CC</sub> + 0.1V		10	μA
I <sub>PP1</sub>	$\overline{CS}/V_{PP}$ (1) Read/Standby Current	$\overline{CS}/V_{PP}$ = -0.1V to V <sub>CC</sub> + 1V		10	μA
I <sub>SB</sub>	V <sub>CC</sub> (1) Standby Current	I <sub>SB1</sub> (CMOS) CS/V <sub>PP</sub> = V <sub>CC</sub> - 0.3 to V <sub>CC</sub> + 1.0V	Com.	35	mA
			Ind., Mil.	40	mA
		I <sub>SB2</sub> (TTL) CS/V <sub>PP</sub> = 2.0 to V <sub>CC</sub> + 1.0V	Com.	35	mA
			Ind., Mil.	40	mA
I <sub>CC</sub>	V <sub>CC</sub> Active Current	f = 10MHz, I <sub>OUT</sub> = 0mA, CS/V <sub>PP</sub> = V <sub>IL</sub>	Com.	75	mA
			Ind., Mil.	90	mA
I <sub>OS</sub> (2)	Output Short Circuit Current	V <sub>OUT</sub> = 0V		-100	mA
V <sub>IL</sub>	Input Low Voltage		-0.6	0.8	V
V <sub>IH</sub>	Input High Voltage		2.0	V <sub>CC</sub> + 1	V
V <sub>OL</sub>	Output Low Voltage	I <sub>OL</sub> = 16mA		.4	V
V <sub>OH</sub>	Output High Voltage	I <sub>OH</sub> = -100μA		V <sub>CC</sub> - 0.3	V
		I <sub>OH</sub> = -4.0mA		2.4	V

5

- Notes: 1. V<sub>CC</sub> must be applied simultaneously or before  $\overline{CS}/V_{PP}$ , and removed simultaneously or after  $\overline{CS}/V_{PP}$ .  
 2. Not more than one output at a time should be shorted. Duration of short circuit test should not exceed 30 sec. This parameter is only sampled and is not 100% tested. See Absolute Maximum Ratings.

**A.C. Characteristics for Read Operation**

		AT27HC641 / AT27HC642										
		-35		-45		-55		-70		-90		Units
Symbol	Parameter	Min	Max	Min	Max	Min	Max	Min	Max	Min	Max	
t <sub>AA</sub> (4)	Address to Output Delay	Com.	35	45	55	70	90	ns				
		Ind., Mil		45	55	70	90	ns				
t <sub>CS</sub> (2,4)	$\overline{CS}/V_{PP}$ to Output Delay		25	30	35	45	55	ns				
t <sub>CD</sub> (3,4,5)	$\overline{CS}/V_{PP}$ to Output Float	0	25	0	30	0	35	0	40	0	45	ns

Notes: 2, 3, 4, 5. - see AC Waveforms for Read Operation.





### A.C. Waveforms for Read Operation <sup>(1)</sup>

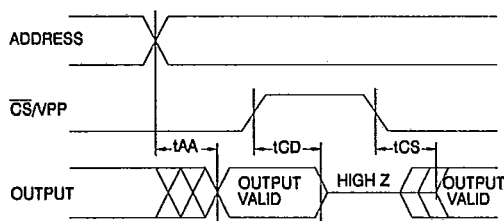

- Notes:
1. Timing measurement reference is 1.5V. Input AC driving levels are 0.0V and 3.0V, unless otherwise specified.
  2. Asserting  $\overline{CS}/V_{PP}$  may be delayed up to  $t_{AA} - t_{CS}$  after the address transition without impact on access time.
  3. This parameter is only sampled and is not 100% tested.
  4.  $C_L = 30\text{pF}$ , add 10ns for  $C_L = 100\text{pF}$ .
  5. Output float is defined as the point when data is no longer driven.

### Input Test Waveforms and Measurement Levels

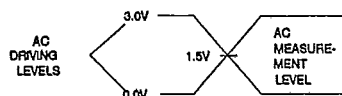

$t_R, t_F < 5\text{ns}$  (10% to 90%)

### Output Test Load

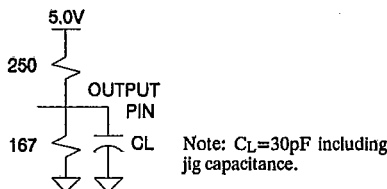

### Pin Capacitance ( $f = 1\text{MHz}$ $T = 25^\circ\text{C}$ ) <sup>(1)</sup>

	Typ	Max	Units	Conditions
$C_{IN}$	4	6	pF	$V_{IN} = 0V$
$C_{OUT}$	8	12	pF	$V_{OUT} = 0V$

Notes: 1. Typical values for nominal supply voltage. This parameter is only sampled and is not 100% tested.

### Programming Waveforms <sup>(1)</sup>

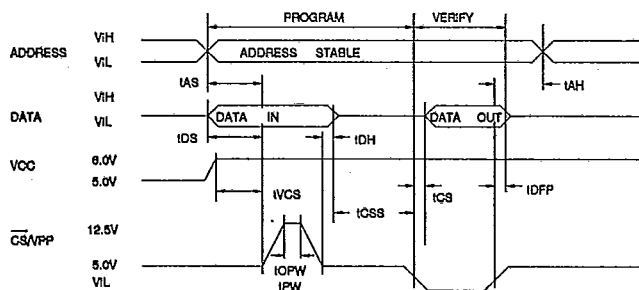

- Notes:
1. The Input Timing References are 0.0V for  $V_{IL}$  and 3.0V for  $V_{IH}$ .
  2.  $t_{CS}$  and  $t_{IDFP}$  are characteristics of the device but must be accommodated by the programmer.

**AT27HC641/2**

T-46-13-29

**D.C. Programming Characteristics**

$T_A=25\pm 5^\circ C$ ,  $V_{CC}=6.0\pm 0.25V$ ,  $\overline{CS}/V_{PP}=12.5\pm 0.5V$

Sym- bol	Parameter	Test Conditions	Limits		Units
			Min	Max	
I <sub>LI</sub>	Input Load Current	$V_{IN}=V_{IL}, V_{IH}$	10		$\mu A$
V <sub>IL</sub>	Input Low Level	(All Inputs)	-0.6	0.8	V
V <sub>IH</sub>	Input High Level		2.0	$V_{CC}+1$	V
V <sub>OL</sub>	Output Low Volt.	$I_{OL}=16mA$	.4		V
V <sub>OH</sub>	Output High Volt.	$I_{OH}=-4.0mA$	2.4		V
I <sub>CC2</sub>	V <sub>CC</sub> Supply Current (Program and Verify)		80		mA
I <sub>PP2</sub>	$\overline{CS}/V_{PP}$ Supply Current	$\overline{CS}/V_{PP}=V_{PP}$	30		mA
V <sub>ID</sub>	A9 Product Iden- tification Voltage		11.5	12.5	V

**Atmel's 27HC641/2 Integrated Product Identification Code:**

Codes	Pins										Hex Data
	A0	O7	O6	O5	O4	O3	O2	O1	O0		
Manufacturer	0	0	0	0	1	1	1	1	1	1	1F
Device Type	1	0	0	0	1	0	0	0	0	0	10

**Fast Programming Algorithm**

Two 12.5V  $\overline{CS}/V_{PP}$  pulse widths are used to program; initial and overprogram. Ai are set to address the desired byte. V<sub>CC</sub> is raised to 6.0V. The first  $\overline{CS}/V_{PP}$  pulse is 1ms. The programmed byte is then verified. If the byte programmed successfully, then an overprogram  $\overline{CS}/V_{PP}$  pulse is applied for 3ms. If the byte fails to program after the first 1ms pulse, then up to 25 successive 1ms pulses are applied with a verification after each pulse. When the byte passes verification, the overprogram pulse width is 3X (times) the number of 1ms pulses required earlier (75ms max).

5

If the part fails to verify after 25 1ms pulses have been applied, it is considered as failed. After the first byte is programmed, the Ai are set to the next address repeating the algorithm until all required addresses are programmed. Then V<sub>CC</sub> is lowered to 5.0V. All bytes subsequently are read to compare with the original data to determine if the device passes or fails.

**A.C. Programming Characteristics**

$T_A=25\pm 5^\circ C$ ,  $V_{CC}=6.0\pm 0.25V$ ,  $\overline{CS}/V_{PP}=12.5\pm 0.5V$

Sym- bol	Parameter	Test Conditions* (see Note 1)	Limits		Units
			Min	Max	
t <sub>AS</sub>	Address Setup Time		2		$\mu s$
t <sub>CSS</sub>	$\overline{CS}/V_{PP}$ Setup Time		2		$\mu s$
t <sub>DS</sub>	Data Setup Time		2		$\mu s$
t <sub>AH</sub>	Address Hold Time		0		$\mu s$
t <sub>DH</sub>	Data Hold Time		2		$\mu s$
t <sub>DFF</sub>	$\overline{CS}/V_{PP}$ High to Output Float Delay	(Note 2)	0	130	ns
t <sub>VCS</sub>	V <sub>CC</sub> Setup Time		2		$\mu s$
t <sub>PW</sub>	$\overline{CS}/V_{PP}$ Initial Pro- gram Pulse Width	(Note 3)	0.95	1.05	ms
t <sub>OPW</sub>	$\overline{CS}/V_{PP}$ Overprogram Pulse Width	(Note 4)	2.85	78.75	ms
t <sub>CS</sub>	Data Valid from $\overline{CS}/V_{PP}$		70		ns

**\*A.C. Conditions of Test:**

- Input Rise and Fall Times (10% to 90%) ..... 5ns
- Input Pulse Levels ..... 0.0V to 3.0V
- Input Timing Reference Level ..... 1.5V
- Output Timing Reference Level ..... 1.5V

**Notes:**

1. V<sub>CC</sub> must be applied simultaneously or before  $\overline{CS}/V_{PP}$  and removed simultaneously or after  $\overline{CS}/V_{PP}$ .
2. This parameter is only sampled and is not 100% tested. Output Float is defined as the point where data is no longer driven — see timing diagram.
3. Initial Program Pulse width tolerance is 1msec±5%.
4. The length of the overprogram pulse may vary from 2.85 msec to 78.75 msec as a function of the iteration counter value X.

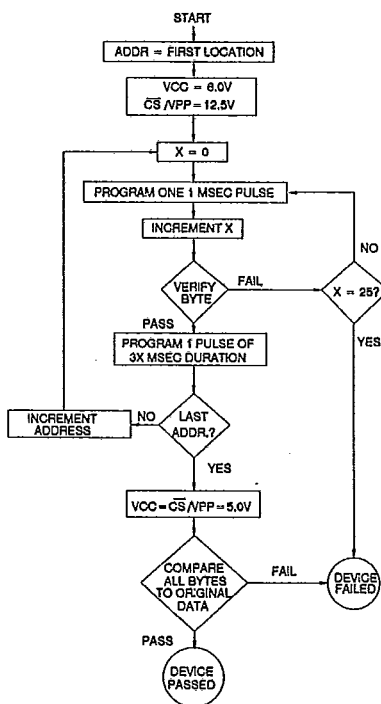



## Ordering Information

t <sub>ACC</sub> (ns)	I <sub>CC</sub> (mA)		Ordering Code	Package	Operation Range
	Active	Standby			
35	75	35	AT27HC641-35DC	24DW6	Commercial (0°C to 70°C)
			AT27HC642-35DC	24DW3	
			AT27HC641-35LC	28LW	
45	75	35	AT27HC641-45DC	24DW6	Commercial (0°C to 70°C)
			AT27HC642-45DC	24DW3	
			AT27HC641-45LC	28LW	
45	90	40	AT27HC641-45DI	24DW6	Industrial (-40°C to 85°C)
			AT27HC642-45DI	24DW3	
			AT27HC641-45LI	28LW	
			AT27HC641-45DM	24DW6	Military (-55°C to 125°C)
			AT27HC642-45DM	24DW3	
			AT27HC641-45LM	28LW	
55	75	35	AT27HC641-45DM/883	24DW6	Military/883C Class B, Fully Compliant (-55°C to 125°C)
			AT27HC642-45DM/883	24DW3	
			AT27HC641-45LM/883	28LW	
55	90	40	AT27HC641-55DC	24DW6	Commercial (0°C to 70°C)
			AT27HC642-55DC	24DW3	
			AT27HC641-55LC	28LW	
			AT27HC641-55PC	24P6	Industrial (-40°C to 85°C)
			AT27HC642-55PC	24P3	
			AT27HC641-55DI	24DW6	
55	90	40	AT27HC642-55DI	24DW3	Industrial (-40°C to 85°C)
			AT27HC641-55LI	28LW	
			AT27HC641-55PI	24P6	
			AT27HC642-55PI	24P3	Military (-55°C to 125°C)
			AT27HC641-55DM	24DW6	
			AT27HC642-55DM	24DW3	
70	75	35	AT27HC641-55LM	28LW	Military/883C Class B, Fully Compliant (-55°C to 125°C)
			AT27HC641-55DM/883	24DW6	
			AT27HC642-55DM/883	24DW3	
70	90	40	AT27HC641-55LM/883	28LW	Commercial (0°C to 70°C)
			AT27HC641-70DC	24DW6	
			AT27HC642-70DC	24DW3	
			AT27HC641-70LC	28LW	Industrial (-40°C to 85°C)
			AT27HC641-70PC	24P6	
			AT27HC642-70PC	24P3	
70	90	40	AT27HC641-70DI	24DW6	Industrial (-40°C to 85°C)
			AT27HC642-70DI	24DW3	
			AT27HC641-70LI	28LW	
			AT27HC641-70PI	24P6	Military (-55°C to 125°C)
			AT27HC642-70PI	24P3	
			AT27HC641-70DM	24DW6	
			AT27HC642-70DM	24DW3	
			AT27HC641-70LM	28LW	

**AT27HC641/2**

T-46-13-29

**Ordering Information**

tACC (ns)	Icc (mA)		Ordering Code	Package	Operation Range
	Active	Standby			
70	90	40	AT27HC641-70DM/883 AT27HC642-70DM/883 AT27HC641-70LM/883	24DW6 24DW3 28LW	Military/883C Class B, Fully Compliant (-55°C to 125°C)
90	75	35	AT27HC641-90DC AT27HC642-90DC AT27HC641-90LC AT27HC641-90PC AT27HC642-90PC	24DW6 24DW3 28LW 24P6 24P3	Commercial (0°C to 70°C)
90	90	40	AT27HC641-90DI AT27HC642-90DI AT27HC641-90LI AT27HC641-90PI AT27HC642-90PI	24DW6 24DW3 28LW 24P6 24P3	Industrial (-40°C to 85°C)
			AT27HC641-90DM AT27HC642-90DM AT27HC641-90LM	24DW6 24DW3 28LW	Military (-55°C to 125°C)
			AT27HC641-90DM/883 AT27HC642-90DM/883 AT27HC641-90LM/883	24DW6 24DW3 28LW	Military/883C Class B, Fully Compliant (-55°C to 125°C)
45	90	40	5962-87515 01 JX 5962-87515 01 KX 5962-87515 01 LX 5962-87515 01 3X	24DW6 24FW 24DW3 28LW	Military/883C Class B, Fully Compliant (-55°C to 125°C)
55	90	40	5962-87515 02 JX 5962-87515 02 KX 5962-87515 02 LX 5962-87515 02 3X	24DW6 24FW 24DW3 24LW	Military/883C Class B, Fully Compliant (-55°C to 125°C)
70	90	40	5962-87515 03 JX 5962-87515 03 KX 5962-87515 03 LX 5962-87515 03 3X	24DW6 24FW 24DW3 28LW	Military/883C Class B, Fully Compliant (-55°C to 125°C)
90	90	40	5962-87515 04 JX 5962-87515 04 KX 5962-87515 04 LX 5962-87515 04 3X	24DW6 24FW 24DW3 28LW	Military/883C Class B, Fully Compliant (-55°C to 125°C)

5

Package Type	
24DW3	24 Lead, 0.300" Wide, Windowed, Ceramic Dual Inline Package (Cerdip)
24DW6	24 Lead, 0.600" Wide, Windowed, Ceramic Dual Inline Package (Cerdip)
24FW	24 Lead, Windowed, Ceramic Bottom-Brazed Flat Package (Flatpack)
28LW	28 Pad, Windowed, Ceramic Leadless Chip Carrier (LCC)
24P3	24 Lead, 0.300" Wide, Plastic Dual Inline Package OTP (PDIP)
24P6	24 Lead, 0.600" Wide, Plastic Dual Inline Package OTP (PDIP)

