

WINTER 1977

The

itty

bitty

machine co., inc.

1322 CHICAGO AVENUE
EVANSTON, ILLINOIS 60201
312-328-6800

42 WEST ROOSEVELT ROAD
LOMBARD, ILLINOIS 60148
312-620-5808

NOTICE: Please spell out our
name fully in small letters
because we don't want to be
confused with any other computer
company selling hardware
under our initials.

PUT A MACRO IN YOUR MICRO!



A new horizon in micro computing for the business, industrial, education and personal computer user has been accomplished with the introduction of the Alpha Microsystems' advanced total system design. From the beginning the goal has been to produce an integrated system that takes advantage of excellent hardware working with superb software to give the computer owner and operator true computer capability and reliability. The forerunner of such a system was the common bus structure that appeared in the personal computing market and was soon embraced by hundreds of manufacturers.

The common bus is the S-100. This allows the integration of computer systems with a choice of components, all using common specifications and design criteria. Alpha Microsystems determined that the idea of implementing their computer system on the S-100 bus was also the most practical and feasible way to proceed.

SYSTEM FEATURES

- 16 bit processor.
- Multi-user, multi-tasking, timesharing disk operating system.
- Disk file management system and utilities.
Multi-user structured file system with passwords.
- Multiple pass Macro-assembler with linking loader.
- Hardware floating point arithmetic to 11 significant digits.
- Eight 16 bit general purpose registers.
- Real-time clock.
- AlphaBasic™ extended compiler and reentrant runtime software.
- Completely device independent.
Multiple level DMA and vectored interrupt systems.
- ISAM support in higher level languages.
- Complete hardware and software flexibility.
Up to 10 times the throughput of most 8-bit systems.
- File management system with logical file I/O calls.

AMOS

The Alpha Microsystems Operating Systems (AMOS) is a disk-based time-sharing system which the experienced user will find offers many features previously found only in large computer systems.

MULTI-TASKING

Multi-tasking allows different jobs to be run concurrently on the system by different users and system functions where the tasks may be controlled from individual terminals or under a single terminal. A command language allows the

automatic initiation of a series of tasks similar to "batch mode processing" on larger computers. Jobs may initiate other jobs automatically within a series or they may start up independent jobs in other jobstream. All tasks must reside in the main memory during execution with concurrent task support depending on the type of function being performed and the main memory available. Segmentation of tasks maximizes memory utilization.

MULTI-USER

The system supports multiple user jobs under an account number structure which protects each user's files from alteration by other users. Each user account contains its own file system on disk with the job run memory being dynamically allocated when the user logs on. Accounts may optionally have a security password associated with them to prevent unauthorized access to the system.

TIMESHARING

When multiple jobs request CPU or I/O resources, the monitor schedules the sharing based on the real-time clock on the CPU Board. Software commands allow the setting of priorities to different jobs for the control of the scheduling function. Jobs in the I/O or sleep states do not require CPU time and are bypassed by the job scheduler increasing processing time efficiency.

DEVICE INDEPENDENCE

Internal to the monitor are a set of file service routines which handle all I/O transfers to and from the peripheral devices. Implementing a new device into the system merely involves writing a device driver to perform the physical read and write functions to the new device and putting the driver onto the disk. All programs and system commands will then operate with that device without modification.

COMMAND LANGUAGE

All commands entered into the jobstream are processed by the monitor which then initiates the desired task. The command language allows a series of command to be created in an ASCII file with a given name, and then executed by that name. Such command files may call other command files, perform direct system functions, or contain parameters to be entered into the job.

SYSTEM UTILITIES

Here are the more important utilities, only a partial list of those available.

DYSTAT—system managers dynamic status display of all jobs.

DEVTBL—allocates device codes to the system.

BITMAP—assigns disk bitmap area to preserve date integrity.

LPTSPL—line printer spooler.

ATTACH—attaches job to a terminal.

DETACH—detaches job from a terminal.

FORCE—forces terminal input to another job.

WAIT—stalls execution in a user's job queue.

KILL—stops execution of a batch program.

SUSPND—puts user's job to sleep.

REVIVE—awakens user's job.

SETPRI—sets priority level of a job.

MEMORY—allocates a memory partition.

SYSTAT—gives user current status of each job in the system.

SYSACT—logs new users and psswords onto system.

MEMTEST—memory test.

BMVR—programs PROMs with Cromemco Bytsaver.

COPY—copies disk files.

DSKCYP—creates backup disks.

DSKANA—disk analysis to test for bad files.

DIR—lists contents of disk by file name.

TYPE—prints disk file on terminal in ASCII.

DSKDMP—dumps disk records on terminal in octal.

ERASE—erases a disk file.

LOAD—loads disk file into memory.

SAVE—save program from memory on disk.

LOG—user logs in on system.

LOGOFF—user signs off.

MAKE—creates a file on disk.

TXTFMT—letter writing text formatter.

languages

THE MACRO ASSEMBLER

The MACRO assembler is a flexible and efficient assembly language development system under the AMOS supervisor which includes the assembler, linkage editor, symbol file generator

and symbolic debug program. The assembler is a multi-pass macro assembler with conditional assembly directives, library copy function and external segment links. The linkage editor is used to link multi-segment programs together and create a runnable program file. The operating system supports segment overlays thereby allowing large programs to be logically divided into smaller segments and executed sequentially. The debug program allows the program to be traced and debugged in symbolic instructions using all the labels as they were entered in the source program.

To be compatible with the AMOS system architecture, all programs must be written in totally relocatable code which means that the program may be loaded anywhere in the RAM and executed without modifying any addresses within the program itself. Machine instructions assist in writing totally relocatable code and by following a few simple restrictions, the writing of assembly language programs for the AM-100 becomes almost foolproof.

AlphaBasic™

AlphaBasic is an extension of the popular BASIC language with several features not found in other implementations. These features not only enhance the performance of traditional uses of the language but make business applications easier to program. COBOL users will find the I/O processing convenient for data manipulation, while the memory mapping system will entice the assembly language programmers who wish to link up their own external routines. Floating point hardware in the processor is fully supported making AlphaBasic faster for mathematical computations than any other BASIC currently implemented in an S-100 bus microprocessor system.

AlphaBasic is a compiler so that only the compiled code and a small runtime package must reside in memory during execution, thereby saving memory space and protecting the program sources. The AlphaBasic compiler and the runtime package are both written in reentrant code so that they may optionally be shared by all users running or debugging programs. The object programs created by the compiler are also totally reentrant and sharable thereby further reducing memory requirements if it is desired to allow several users to run the same program.

Data formats supported are integer, floating point, string and binary variables, either is simple variables or array structures. Variable names are not limited to conventional single character and single digit format but may be any number of alphanumeric characters in length, provided the first character is alphabetic. Another unique feature allow the user to define strings of alphanumeric text and equate them to single keywords which then may be used in either the source text itself or as an immediate mode command.

AlphaBasic supports both sequential and randomly organized files.

LISP

The LIST PROCESSOR is a language

implemented on the AM-100 microcomputer for those interested in a language that is both a formal mathematical language and (with extensions) a convenient programming language. As a formal mathematical language, it is founded upon a particular part of mathematical logic known as recursive function theory. As a programming language, LISP is concerned primarily with the computer processing of symbolic data rather than numeric data. LISP is designed to allow symbolic expressions of arbitrary complexity to be evaluated by a computer.

AM-100

The AM-100 is a 16-bit microprocessor board set, compatible to the S-100 bus structure using Western Digital's advanced WD-16 chipset, micro-programmed to enhance the software of the operating system and high level languages. The micro-processor provides 16-bit flexibility and speed with floating point arithmetic and real-time clock, providing throughput matching many minis. The two-board AM-100 supports most of the standard S-100 bus peripherals; including static memory, I/O facilities and video.

Software is licensed to the board set and is provided as part of the system. Updates, improvements and additions are furnished at moderate handling charges.

Catalog Order No. AM-100 , 16-bit , S-100 Bus Compatible Microprocessor with AMOS™ Operating System , AlphaBasic™ , utilities Assembled.\$1495.00

AM-200

The AM-200 is a S-100 bus compatible, full DMA floppy disk controller based on the Western Digital FD 1771 control chip. This controller has been designed to complement the AM-100 16 bit processor. Inasmuch as disk formatting abilities have been implemented it is probably the most advanced floppy controller available for the S-100 bus.

The AM-200 provides full and partial sector reading from the drive, has multiple drive control and multi-level interrupt capabilities.

For users of the popular 8080 processor, and operating system (CPM) has been implemented and is available.

The AM-200 will support the PerSci model 277, Shugart model 850 and various other soft sectored disk drives.

Catalog Order No. AM-200 floppy disk controller
Catalog Order No. AM-200
Floppy Disk Controller \$695.00

Catalog Order No. AM-201
Floppy Disk Controller
with cabinet, power supply \$995.00

Catalog Order No. AM-202
Floppy Disk Controller, cabinet
power supply, Persi Model 227
Dual Floppy Drive \$2595.00

AM-250

AM-250 Subsystem

The AM-250 subsystem consists of the interface from the S-100 bus to the CALCOMP Trident series of hard surfaced (3330 type) disk drives. This family of disk drives are available in 25, 50, 80, 200 and 300 megabyte configurations with the capability to have 4 such units on-line intermixed.

With average access times of 28 milliseconds large, on-line, direct access files have become a reality in the microprocessor field.

Catalog Order No. AM-250
Disk Controller By Quote Only

AM-300

The AM-300 is a six port serial I/O facility, S-100 bus compatible. It provides six fully programmable RS-232 ports. Individual ports can be set at any of 16 selectable baud rates independently up to 19,200 baud. The entire board can be multi-level interrupted which is under program control. Asynchronous and synchronous operating modes for each port is provided through Western Digital's Asynchronous Synchronous Receiver/Transmitters (ASTRO-UCI671B).

Catalog Order No. AM-300
Serial I/O \$695.00

The
itty bitty
machine co., inc.

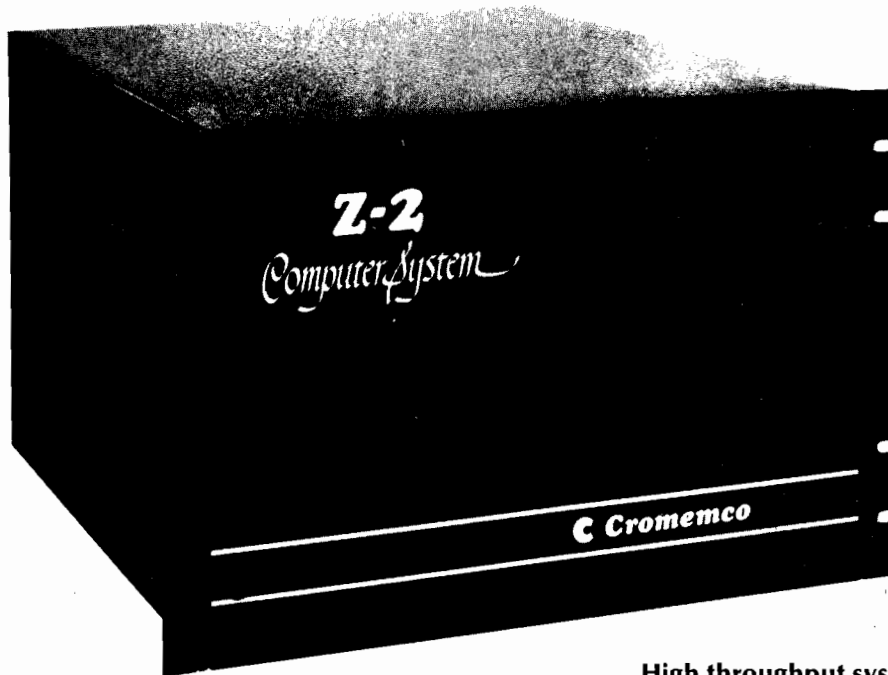

Z-2 Computer System

This new Cromemco Z-2 Computer System provides the engineer, businessman, educator or experimenter with the industry's fastest and most powerful microcomputer in an economical package for dedicated work.

The Z-2 makes available Cromemco's fast Z-80 microprocessor card and a 21-card motherboard in a form such that an almost endless variety of memory, I/O and other peripherals can easily be plugged in — thereby forming a computer tailored to your particular job whether in the laboratory, on the production line, or in an educational time-sharing setup.

Z-2 System

Here are some of the leading features you get in the new Cromemco Z-2 Computer System:

- The industry's fastest μ P board (4 MHz or 250-nanosecond cycle time).
- The power and convenience of the well-known Z-80 microprocessor chip.
- A full-length *shielded* motherboard with 21 card slots to let you plug in almost any conceivable combination of memory, I/O, or your own custom circuits.
- An extremely heavy duty power supply providing 30A from +8V and 15A from +18 and -18V. This will not only power a full set of 21 cards but also has ample additional power for other peripherals such as a floppy disk drive.
- Power-on jump circuitry to begin automatic program execution when power is turned on.
- S-100 bus — important because it is widely supported by a host of peripherals manufacturers. Thus you get the widest possible array of compatible peripherals.
- All-metal chassis and dust case.
- Card retainer that secures cards in sockets.
- Standard rack-mount style construction suited to dedicated applications. Upward compatible with larger systems. Usable with a variety of cabinets. Bench cabinet optional.
- 110 or 220-volt operation.

High throughput system

The Z-2 is based on Cromemco's fast, powerful microprocessor card, the industry's only card that gives 4 MHz operation (250-nanosecond cycle time). This is about twice the speed of any other microcomputer. The speed and power of this Cromemco card are demonstrated by the fact that the Z-2 will perform real-time operations formerly done only by much larger computers.

Because the card uses the powerful Z-80 microprocessor and, in fact, uses a select one capable of 4 MHz speed, the new Z-2 with Cromemco software has up to 10 times the throughput of microcomputers based on the 8080 and previous microprocessors.

The Z-80 is widely regarded as the standard microprocessor of the future. Besides its high speed, the Z-80 offers a 158-instruction set, 19 internal registers, 10 addressing modes, and 16-bit arithmetic operations.

So you're in the technical fore with the Z-2. But you can also plug in other microprocessor boards if you wish.

Dedicated applications

The new Z-2 is specifically designed as a powerful but economical dedicated computer for systems work. Hence, the front panel has been made free and clear of switches and controls of any kind. This makes the Z-2 immune to accidental or incidental misadjustments of operating controls which could be troublesome and costly in dedicated applications such as industrial control.

Low noise

A number of measures have been taken in the design of the Z-2 to achieve reliable operation at its fast 4 MHz speed. Special fast memories (e.g., p. 13) have been developed, the fastest in the industry. Noise has generally been minimized, particularly on the motherboard. A unique ground-plane design has been developed, for example, that reduces ground-current noise by several dB on the bus to prevent erratic operation. This design feature is called 'Blitz-Bus'[™]

Rack/Cabinet mounting

The basic Z-2 is supplied in a black-anodized metal case for mounting in a standard 19-inch relay rack. A quality stylized bench cabinet in an attractive blue color is also available.



Model Z-2D Computer System is supplied for rack mounting. Optional bench and floor-model cabinets are available.

Z-2D Disk Computer

Loading your programs and files will take you only a few seconds with the new Cromemco Z-2D computer.

You can load fast because the Z-2D comes equipped with a 5" floppy disk drive and controller. Each diskette will store up to 92 kilobytes.

Diskettes will also store your programs inexpensively—much more so than with ROMs. And ever so much more conveniently than with cassettes or paper tape.

The Z-2D itself is our fast, rugged, professional-grade Z-2 computer equipped with disk drive and controller. You can get the Z-2D with either single or dual drives (dual shown in photo).

ADVANCED CONTROLLER CARD

The new Z-2D is a professional system that gives you professional performance.

In the Z-2D you get our well-known 4-MHz CPU card, the proven Z-2 chassis with 21-slot motherboard and 30-amp power supply that can handle 21 cards and dual floppy

drives with ease.

Then there's our new disk controller card with special features:

- Capability to handle up to 4 disk drives
- A disk bootstrap Monitor in a 1K 2708 PROM
- An RS-232 serial interface for

interfacing your CRT terminal or teletype.

- LSI disk controller circuitry

We're able to put all of this including a UART for the CRT interface on just one card because we've taken the forward step of using LSI controller circuitry.

CROMEMCO HAS THE SOFTWARE

You can rely on this: Cromemco is committed to supplying quality software support.

For example, here's what's now available for our Z-2D users:

CROMEMCO FORTRAN IV COMPILER: a well-developed and powerful FORTRAN that's ideal for scientific use. Produces optimized, relocatable Z-80 object code.

CROMEMCO 16K DISK BASIC: a powerful pre-compiling interpreter with 14-digit precision and powerful I/O handling capabilities. Particularly suited to business applications.

CROMEMCO Z-80 ASSEMBLER: a macro-assembler that produces relocatable object code. Uses standard Z-80 mnemonics.

TECHNICAL SPECIFICATIONS Z-2 COMPUTER SYSTEM

Processor: 4 MHz version Z-80
Cycle time: 250 nanoseconds
Minimum instruction execution time: 1 microsecond
Instruction set: 158 instructions including the 78 instructions of the 8080
System bus: industry standard S-100
Board capacity: 21 boards
Power supply: +8 volts @ 30A, +18 volts @ 15A, -18 volts @ 15A
Power: Operates from 110/220 volts; 50/60 cycles.
Operating environment: 0-55°C
Dimensions: 12 1/4" H x 19" W x 20 3/4" D
 (31.1 x 48.3 x 52.7 cm)
Weight: 39 lbs (18 kg)
Mounting: For rack mounting (optional bench cabinet available)

TECHNICAL SPECIFICATIONS Z-2D DISK COMPUTER SYSTEM

PROCESSOR: 4 MHz version Z-80
CYCLE TIME: 250 nanoseconds
MINIMUM INSTRUCTION EXECUTION TIME:
 1 microsecond
INSTRUCTION SET: 158 instructions including the 78 instructions of the 8080
SYSTEM BUS: Industry standard S-100
BOARD CAPACITY: 21 boards
DISK DRIVE CAPACITY: 2 drives (supplied with one drive)
DISK STORAGE CAPACITY: 92K bytes each disk
PROM FIRMWARE: 1K bytes (2708 PROM)
SERIAL INTERFACE: RS-232 or current loop; 110 to 76,800 baud
PARALLEL INTERFACE: 8 bit TTL levels
POWER SUPPLY: +8 volts @ 30A, +18v @ 15A, -18v @ 15A
POWER: operates from 110/220 volts; 50/60 cycle
OPERATING ENVIRONMENT: 0-55°C
DIMENSIONS: 12 1/4" H X 19" W X 20 3/4" D
 (31.1 X 48.3 X 52.7 cm)
WEIGHT: 49 lbs (22 kg)
MOUNTING: For rack mounting (optional cabinets available)

Catalog Order No. Z-2k
Cromemco Z-2 Computer System Kit: Z-2 for rack-mounting, Z-80 4MHz microprocessor card, 2l card motherboard, power supply.....\$ 595.00

Catalog Order No. Z-2W
Cromemco Z2- Computer System Assembled: Above as well as 2l sockets and card guides and a cooling fan.....\$ 995.00

Catalog Order No. Z-2DK
Cromemco Z-2 Disk Computer System Kit Z-2 rackmount cabinet, Z-80 4MHz microprocessor card, 2l card motherboard, power drive and controller, and front plate.....\$1495.00

Catalog Order no. Z-2W
Cromemco Z-2 Disk Computer System Assembled: Above as well as 2l sockets and card guides and a cooling fan.....\$2095.00

Z-2 Accessories

- **CABINET.** High quality all-aluminum cabinet with blue finish. Fold away handles. Outside dimensions 13" x 20" x 26". Weight 25 lbs.
- **BLANK FRONT PANEL.** Black-anodized blank front panel for your customized computer system.

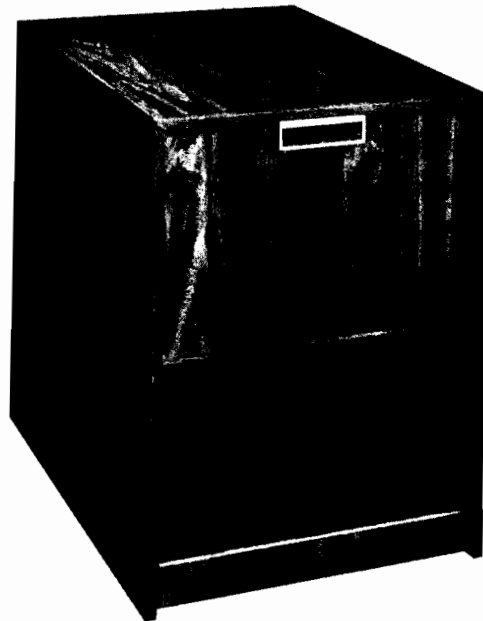

Optional oiled-walnut floor cabinet for Z-2D Computer System.

Catalog Order No. Z-2RDK
Retrofit package for Z-2D containing disk and controller kit.....\$ 935.00

Catalog Order No. Z-2RDW
Retrofit package for Z-2D containing disk and controller assembled.....\$1135.00

Catalog Order No. Z-2WCB
Oiled walnut floor cabinet..... \$ 595.00

Catalog Order No. Z2-CAB
Blue aluminum blue finish cabinet....\$ 195.00

Catalog Order No. Z2-BFP
Blank front panel.....\$ 35.00

Disk Controller

SIMULTANEOUSLY INTERFACES UP TO
FOUR DISK DRIVES

This card is not only a disk controller but also an I/O interface.

Placing many functions on this one card is possible because we have taken the step of using LSI circuitry.

The card is capable of simultaneously interfacing up to three 5" drives or four 8" drives.

Its interface provisions include an RS-232 serial interface with a baud range up to 76,800 baud.

The bootstrap monitor is contained in a 1K 2708 PROM.

TECHNICAL SPECIFICATIONS 4FDC DISK CONTROLLER AND I/O INTERFACE

DISK CONTROLLER:

Maximum number of 5" drives: 3
Maximum number of 8" drives: 4
Bootstrap/Monitor firmware: 1K byte PROM
Controller circuitry: MOS LSI

SERIAL I/O PORT:

I/O levels: RS-232 or 20 mA current loop
Low baud range: 110 - 9600 baud (software selectable)
High baud range: 880 - 76,800 baud (software selectable)

PARALLEL PORT:

Input port: 8 bits
Output port: 8 bits
Input load: one TTL equivalent
Output drive: 20 TTL loads

INTERVAL TIMERS:

Number of timers: 5
Timer range: 0 - 16.32 msec (software selectable)
Timer resolution: 64 microseconds

GENERAL INFORMATION:

Disk controller type: 1771-1
UART type: 5501
PROM type: 2708
Bus: S-100 (one slot only)
Power requirements: +8 volts @ 1.0 A
 +18 volts @ 100 mA
 -18 volts @ 100 mA
Operating environment: 0 - 55°C

Catalog Order No. 4FDC-K
Disk Controller Card Kit.....\$ 395.00

Order No. 4FDC-W
Disk Controller Card Assembled..\$ 595.00

Dual Disk Drive

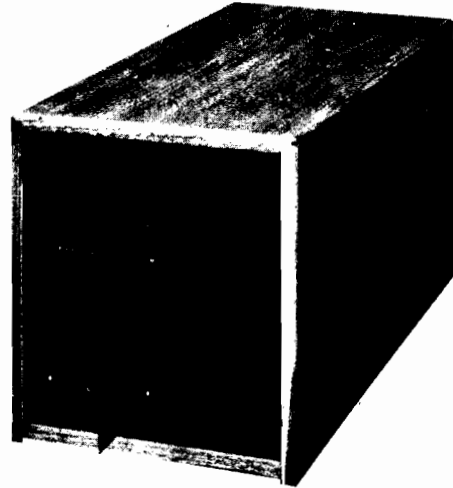

Here is a convenient unit for situations that require 8" dual disks. This is a dual Persci floppy disk drive complete with case, power supply and cables to connect to the S-100 bus interface in our 4FDC Controller Card (used in the Z-2D computer).

Use with Cromemco Disk
Controller Card Model 4FDC

Drive is supplied in oiled walnut
cabinet

Catalog Order No. PFD-K
Dual 8" Disk Drive Kit
(w/o Controller).....\$1995.00

Catalog Order No. PFD-W
Dual 8" Disk Drive Assembled
(w/o Controller).....\$2495.00

Cromemco

4 MHz CPU card

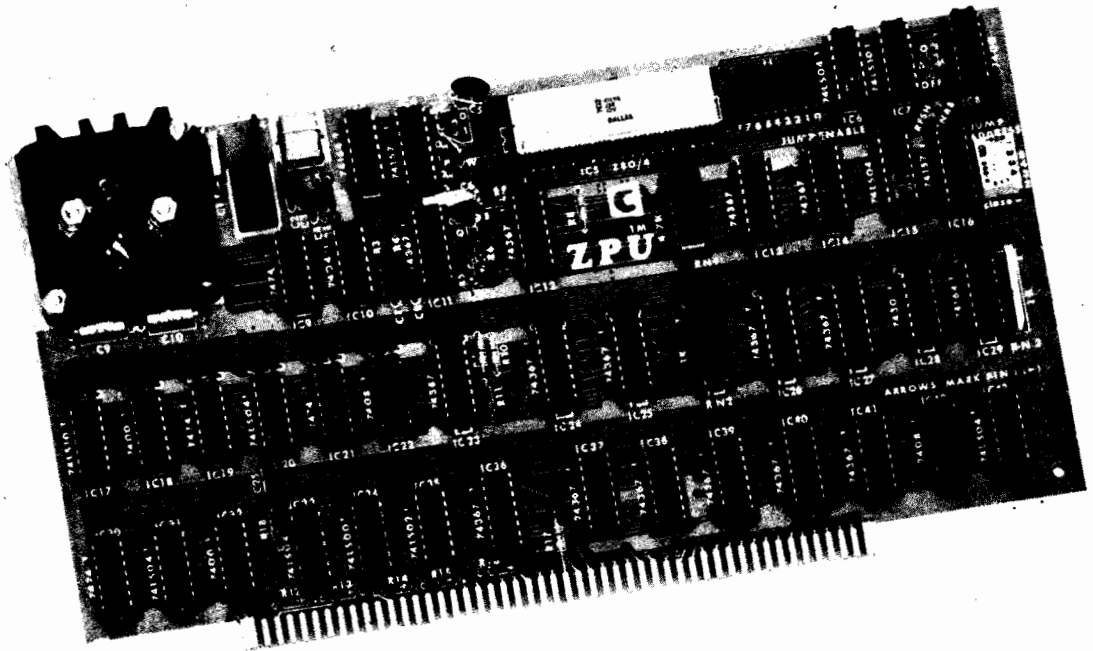

- Uses special Z80 microprocessor
- Fast—4 MHz clock rate
- Does not require front panel for operation

2-5X MORE THROUGHPUT

Here is by far the most powerful CPU card now available. (It is the heart of our Z1 and Z2 computers.)

It's Cromemco's new Z80-CPU card.

It uses the slick new Z-80 chip—in fact, it uses a special high-speed version of the Z-80—and it's the *only* card that does. This special Z80 is certified by its manufacturer for 4 MHz operation.

The Z80 has all the advantages of the 8080 and 6800—and enormously more.

And Cromemco's new Z80-CPU card does enormously more.

4 MHz CLOCK RATE

First, this CPU lets you choose either a 2 or 4 MHz crystal-controlled clock rate. Right away that means you can have twice the throughput. Cuts program running time in half. Then the instruction set of the Z80 reduces software even more.

The 2 or 4 MHz clock rate is switch-selectable as shown in the above photo.

POWER-ON MEMORY JUMPS

Cromemco's CPU also has some neat design innovations of its own.

For example, you'll like the simplified operation you get because upon power turn-on the CPU will jump to any desired 4K boundary in memory. No switch flipping to go through to begin your program. So you can also use this CPU card in stand-alone sys-

tems—and it can be operated without need of a front panel.

80 ADDITIONAL INSTRUCTIONS

You've probably heard that the Z-80 with its 80 new additional instructions is by far the most powerful chip around. It's true.

That means with our CPU you will be able to devise much more powerful (as well as faster) software than before.

ALTAIR/IMSAI COMPATIBLE WITHOUT MODIFICATION

Yes, the new CPU is plug-compatible with the Altair 8800, 8800A, and IMSAI 8080. Just remove the existing CPU, plug in the Z80/CPU, and you're

up and running.

Further, the Cromemco CPU is the only card guaranteed to work with all present and future Cromemco peripherals. (Cromemco manufactures the popular BYTESAVER™ memory, the TV DAZZLER™, the D + 7A™ analog interface board, a joystick console, and others.)

INCLUDES FREE SOFTWARE

The CPU comes with our powerful Z-80 monitor, complete documentation, source code, and paper tape object code. The monitor is also available in PROM (\$50) for use in our BYTESAVER or 16 KPR memory boards.

TECHNICAL SPECIFICATIONS Z-80 MICROPROCESSOR CARD

PROCESSOR: 4 MHz version of the Z-80.

CLOCK RATE: 2/4 MHz (switch selectable).

INSTRUCTION SET: 158 instructions including the 78 instructions of the 8080.

POWER-ON JUMP: jumper wire enabled.

POWER-ON JUMP LOCATIONS: 16 locations switch selectable.

WAIT STATE GENERATION:

0 - 4 wait states jumper wire selectable.

M1 WAIT STATE: jumper wire selectable.

BUS: S-100.

POWER REQUIREMENTS: +8 volts @ 1.1 A.

OPERATING ENVIRONMENT: 0 - 55°C.

Catalog Order No. ZPU-K
Z80 CPU Kit..... \$ 295.00

Catalog Order No. ZPU-W
Z80 CPU Assembled...\$ 395.00

4K RAM card

You probably know our Z-80 CPU card. It's the finest and most powerful card available. Not only does it have a guaranteed speed of 4 MHz and a crystal-controlled 2/4 MHz clock rate, it also has a **power-on memory jump feature** that greatly simplifies starting-up.

Now we've developed an outstanding 4K RAM memory card for this CPU card (or for any S-100 bus CPU card). **Our new Model 4KZ is a static memory that has:**

- (1) a guaranteed speed of 4 MHz
- (2) a memory-bank-select feature.

As you would expect with a Cromemco product, this new Model 4KZ gives you advanced performance at low cost. It achieves its 4 MHz speed while using proven, reliable, low-power memory chips (21L02's). How? By a novel design that uses address anticipation.

ENORMOUSLY EXPANDABLE

You get staggering expandability in the new 4KZ — to 512 kilobytes if you'd like.

Here's how: with the 4KZ you can organize memory into as many as 8 banks of 64K bytes each.

Then an 8-position switch on the 4KZ selects a given bank.

With memory expandability like that, Cromemco's CPU and RAM cards are the basic hardware for a broad range of jobs — even jobs that until now were only for large computers.

TECHNICAL SPECIFICATIONS 4KZ RAM

MEMORY CAPACITY: 4K bytes.
MEMORY TYPE: 21L02 RAM.
MEMORY ACCESS TIME: 450 nanoseconds.
WAIT STATES AT 2 MHz: none required.
WAIT STATES AT 4 MHz: on non-sequential addresses only.
BUS: S-100.
POWER REQUIREMENTS: +8 volts @ 0.8 A.
OPERATING ENVIRONMENT: 0 - 55°C.

Catalog Order No. 4-KZ-K
4K Static RAM Memory Kit....\$ 195.00
Catalog Order No. 4KZ-W
4K Static RAM Memory Assembled...\$ 295.00

16K RAM card

- The fastest available
- No wait states required at either 2 or 4 MHz operation
- Offers expandability to a half megabyte with Bank Select
- Can be used for time-sharing (up to 8 users)
- Dynamic refresh fully transparent

FAST, EXPANDABLE

Not only is this the fastest 16K RAM card available but it is expandable to a half megabyte. It will operate at 4 MHz with no wait states.

TIME SHARING

One of the best examples of the power of the Bank-Select feature is that it will let you achieve a time-share system with minimum software overhead.

Each user (there can be up to 8) will be confined to his own bank of memory.

S-100 BUS COMPATIBILITY

This memory can be plugged into any S-100 bus computer. That includes the Cromemco Z-1 and Z-2, the Altair 8800, the IMSAI 8080, and others.

START WITH THE BEST

Sooner or later you'll inevitably want larger memory. So start with Cromemco and be sure you'll have the expandability and high-speed performance you'll need.

TECHNICAL SPECIFICATIONS 16KZ RAM CARD

MEMORY CAPACITY: 16K bytes.
MEMORY TYPE: 4050-2 RAM.
MEMORY ACCESS TIME: 200 nanoseconds.
WAIT STATES AT 2 MHz: none required.
WAIT STATES AT 4 MHz: none required.
BUS: S-100.
POWER REQUIREMENTS: +8 volts @ 0.8 A
+18 volts @ 0.5 A
-18 volts @ 10 mA
OPERATING ENVIRONMENT: 0 - 55°C.

Catalog Order No. 16KZ-K
16K RAM Memory Kit.....\$ 495.00
Catalog Order No. 16KZ-W
16K RAM Memory Assembled.....\$ 795.00

with Bank Select

Memory bank select is a feature incorporated on Cromemco memory boards that allows the expansion of memory space beyond 64K bytes. With bank select, memory space may be organized into 8 banks of 64K bytes each for a total of one-half megabyte memory.

With bank select each memory board may reside in one or more of the 8 possible memory banks. An 8-position DIP switch on the board is used to select each of the banks in which the board resides.

The active bank or banks of memory are selected under software control. Output port

40H is dedicated to this function. Each of the 8 bits of data of output port 40H are used to turn on or off the corresponding bank of memory. A "1" in the corresponding bit position will turn on the memory bank. A "0" will turn it off. All circuitry required to detect the output of port 40H is included on the memory card itself.

Bank select provides a convenient method by which to expand system memory space beyond 64K. Bank select also permits the implementation of time-sharing systems with a minimum of software overhead — up to 8 users can use the system simultaneously with each confined to his own bank of memory.

Cromemco BYTESAVER

Cromemco's popular BYTE-SAVER™ memory board gives you two of the most-wanted features in microcomputer work:

- (1) a simple, easy way to store your computer programs in programmable read only memory (PROM).
- (2) A PROM memory board with the capacity for a full 8K bytes of PROM memory storage.

ECONOMICAL

The BYTESAVER™ is both a place and a way to store programs economically. It transfers programs from the non-permanent computer RAM memory to the permanent PROM memory in the BYTESAVER™. Once your program is in the BYTESAVER™, it's protected from power turn-offs, intentional or accidental. The PROMs used with BYTESAVER™ are UV erasable and can be used again and again.

The BYTESAVER™ itself plugs directly into your Altair 8800 or IMSAI 8080 and of course into the Cromemco Z1 and Z2.

PROM PROGRAMMER

Many people are surprised to learn that in the BYTESAVER™ you also have your own PROM programmer. But it's so. And it saves you up to hundreds of dollars, since you no longer need to buy one separately.

The built-in programmer is designed for the 2708 PROMs. The 2708 holds 1K bytes, four times the capacity of the well-known older 1702 PROM (yet cost-per-byte is about the same). The 2708 is also fast — it lets your computer work at its speed without a wait state. And it's low-powered. With 2708's in all 8 sockets, the BYTESAVER™ still draws only about 500 mA from the +8V bus. A complement of 2708 PROMs gives the BYTESAVER™ its full 8K capacity.

RESIDES IN MEMORY

Note that the BYTESAVER™ board resides in memory space. Thus PROMs can be programmed using conventional memory-write instructions.

HOLDS LARGE PROGRAMS

The BYTESAVER's™ 8K-byte capacity lets you store the larger and more powerful programs. 8K BASIC, for example, easily fits in the BYTESAVER™ capacity of 8 PROMs. One 1K PROM will hold the Cromemco Z-80 monitor.

16K PROM card with address anticipation and Bank Select

HOLDS UP TO 16 HIGH-SPEED,
ERASABLE 2708 PROMs

Here's what you need when you want the capability for a sizable PROM memory.

The 16KPR holds up to 16 type 2708 or equivalent PROMs (You can program these with the BYTESAVER discussed on p. 8).

The board plugs into your Altair 8800 or IMSAI 8080 as well as the Cromemco Z-1 or Z-2.

BANK SELECT

And the 16KPR has our bank-select feature. That lets the board be part of large memory systems of up to 8 banks of 64K each. See additional information on p. 13.

FAST

The 16KPR will operate with the fastest microcomputers because of its address anticipation feature. This means that there are no wait states required in the usual sequential addressing type of operation.

TECHNICAL SPECIFICATIONS BYTESAVER

MEMORY CAPACITY: 8K bytes.
MEMORY TYPE: 2708 PROM or equivalent.
MEMORY ACCESS TIME: 450 nanoseconds.
WAIT STATES AT 2 MHz: none required.
WAIT STATES AT 4 MHz: one per machine cycle.
BUS: S-100.
POWER REQUIREMENTS: +8 @ 0.5 A
+18 @ 0.4 A
-18 @ 0.2 A
OPERATING ENVIRONMENT: 0 - 55°C.

TECHNICAL SPECIFICATIONS 16KPR PROM CARD

MEMORY CAPACITY: 16K bytes.
MEMORY TYPE: 2708 PROM or equivalent.
MEMORY ACCESS TIME: 450 nanoseconds.
WAIT STATES AT 2 MHz: none required.
WAIT STATES AT 4 MHz: on non-sequential addresses only.
BUS: S-100.
POWER REQUIREMENTS: +8 volts @ 0.4 A
+18 volts @ 0.8 A
-18 volts @ 0.5 A
OPERATING ENVIRONMENT: 0 - 55°C.

Catalog Order No. 16KPR-K
16K PROM Card Kit.....\$ 145.00

Catalog Order No. 16KPR-W
16K PROM Card Assembled.....\$ 245.00

Catalog Order No. BSK-O
Bytesaver Kit w/o PROM.....\$ 145.00

Catalog Order No. BSW-O
Bytesaver Assembled w/o PROM..\$ 245.00

Catalog Order No. BSP
Bytemover PROM for above.....\$ 30.00

TU-ART digital interface with many features

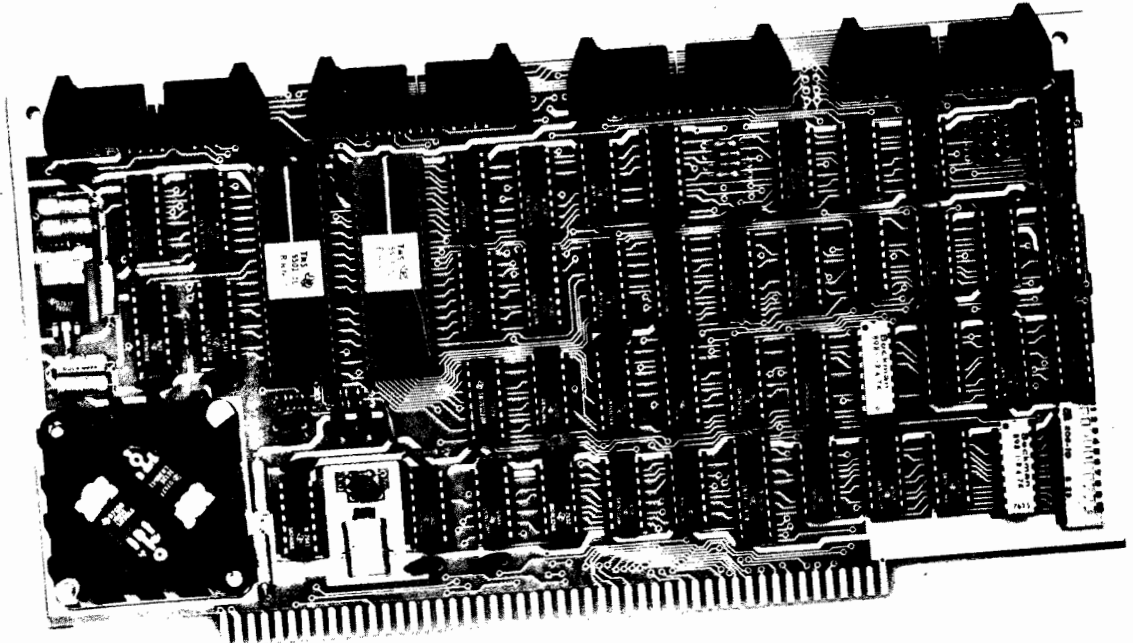

For interfacing with

- CRT terminals
- line printers
- modems
- other devices

FAST – SOFTWARE SELECTABLE BAUD RATES UP TO 76,800 BAUD.

Here's a very convenient interface to let you couple not to one but to two terminals or other devices. So we call it a TU-ART.

It has two serial I/O ports, two 8-bit parallel I/O ports, and 10 independent, programmable interval timers.

Baud rates are software-selectable from 110 to 76,800 baud.

VECTORED INTERRUPTS

Yet another special convenience of the TU-ART is its vectored prioritized interrupts. Is able to support powerful vectored interrupt structure of the Z-80 microprocessor.

INTERVAL TIMERS.

The 10 interval timers, since they have real-time clock capability, offer a very wide range of control possibilities.

Each timer range is from 0 - 16.32 milliseconds and is software selectable.

**Catalog Order No. TRT-K
TU-ART Kit.....\$ 195.00**

**Catalog Order No. TRT-W
TU-ART Assembled.....\$ 295.00**

CABLES

For coupling TU-ART ports to DB-25 inputs
Model TRT-CBL cable\$15 each
(up to 4 req'd.)

Catalog Order No. TRT-CBL...\$ 15.00

TECHNICAL SPECIFICATIONS TU-ART DIGITAL INTERFACE

SERIAL I/O PORTS:

Number of ports: 2.

I/O levels: RS-232 or 20 mA current loop.

Low baud range: 110 - 9600 baud (software selectable)

High baud range: 880 - 76,800 baud (software selectable)

PARALLEL I/O PORTS:

Number of ports: 2

Input ports: 8 bits

Output ports: 8 bits

Input load: one TTL equivalent

Output drive: 20 TTL loads

INTERVAL TIMERS:

Number of timers: 10

Timer range: 0 - 16.32 msec (software selectable).

Timer resolution: 64 microseconds

VECTORED INTERRUPTS:

Number of restart locations (8080 mode): 8

Number of restart locations (Z-80 mode): 65,536

Prioritization of TU-ART ports: internally prioritized

Prioritization for multiple TU-ARTs: daisy-chaining

GENERAL INFORMATION:

UART type: 5501

Bus: S-100

Power requirements: +8 volts @ 1.0 A

+18 volts @ 80 mA

-18 volts @ 40 mA

Operating environment: 0 - 55°C.

Cromemco

D+7A I/O™

Multi-channel microcomputer analog interface

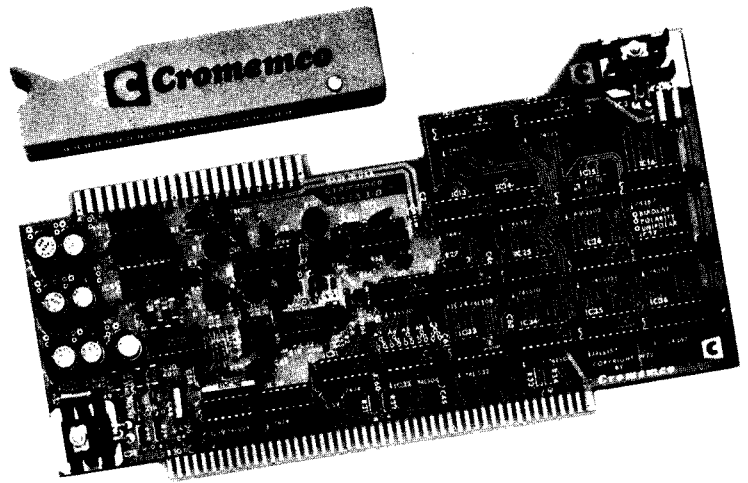

See p. 14 for special joystick console with audio output. Use with this analog I/O.

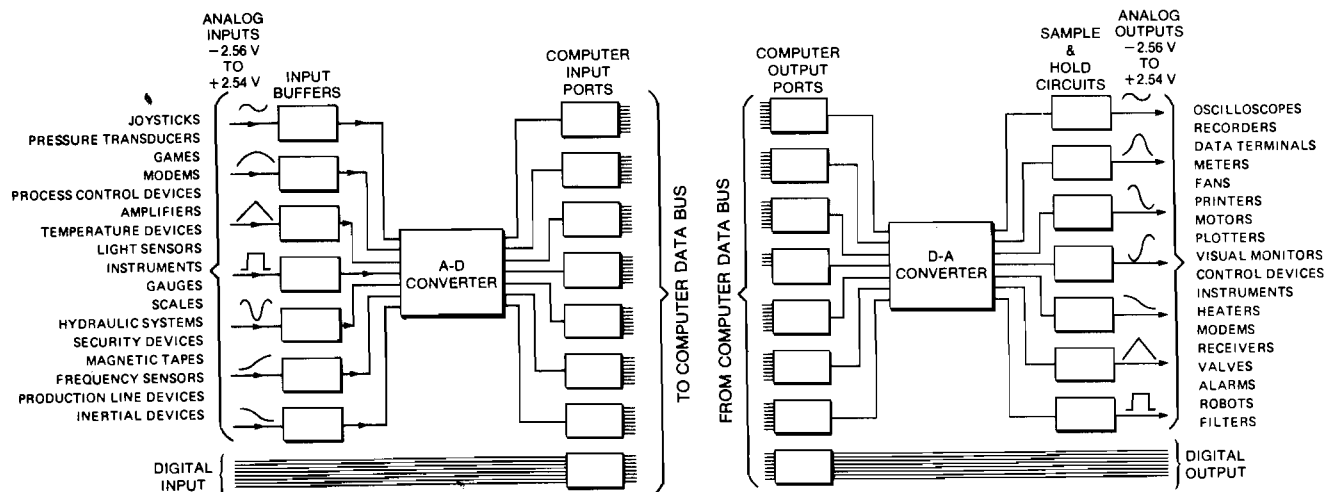

Now you have a way to get analog information into and out of your micro-computer. It's an easy, fast, and unbelievably inexpensive way.

It's Cromemco's new D+7A™ high-performance I/O module which gives you:

- 7 channels of 8-bit analog-to-digital conversion (to input analog data to the computer)
- 7 channels of digital-to-analog conversion (to output computer data in analog form)
- an 8-bit parallel I/O port to input and output data in digital form.
- a fast conversion time of 5.5 microseconds.

A MULTITUDE OF USES

The D+7A makes it easy to use your computer for the jobs you want it to do—such as process control, digital filtering, games, oscilloscope graphics, speech recognition, speech and music synthesis.

The D+7A lets you input and output analog data with all sorts of devices: joysticks, ham radio gear, measurement instruments, machine tools, transducers, control systems, motors, recorders, and plotters, to name just a few.

NO FURTHER SOFTWARE NEEDED

The D+7A I/O plugs directly into the Altair 8800 or IMSAI 8080 micro-computers. Analog signal range is from -2.56 to +2.54 volts (20-millivolt increments) on both input and output sides.

Simple "Input" and "Output" instructions initiate A/D conversion and read in or out the ensuing 8 bits of data. No further software is required.

During conversion the D+7A holds down the computer "Ready" line.

Catalog Order No. D+7A-K
D+7A I/O Kit.....\$ 145.00

Catalog Order No. D+7A-W
D+7A I/O Assembled.....\$245.00

TECHNICAL SPECIFICATIONS D+7A-A/D & D/A INTERFACE

ANALOG INPUT PORTS:

Number of input ports: 7
Input voltage range: -2.56 to +2.54 volts
Input bias current: 2 microamps max.
Input impedance:
20 Megohms || .001 μF,
1 kHz sample rate.
2 Megohms || .001 μF,
10 kHz sample rate.
Resolution: 8 bits.
Conversion time: 5.5 microseconds
Accuracy: ±20 millivolts

ANALOG OUTPUT PORTS:

Number of output ports: 7
Output voltage range: -2.56 to +2.54 volts
Output impedance: 0.25 ohm.

Maximum load current: 1.5 mA
Resolution: 8 bits
Conversion time: 5.5 microseconds
Accuracy: ±20 millivolts
Drift rate: Less than 10 mV/sec at 25°C

PARALLEL I/O PORT:

Input port: 8 bits
Output port: 8 bits
Input load: one TTL equivalent
Output drive: 10 TTL loads

GENERAL INFORMATION:

Bus: S-100.
Power requirements:
+8 volts @ 0.4 A
+18 volts @ 30 mA
-18 volts @ 60 mA

TV Dazzler

Cromemco's new computer/tv interface circuit lets you have a full-color computer display terminal for little more than a black-and-white terminal.

The Cromemco interface also lets you do vastly more with your color terminal than you can do with ordinary black-and-whites.

We call our interface the TV Dazzler™. It consists of two circuit boards that plug directly into your Altair 8800 or IMSAI 8080 computer.

ALPHANUMERIC PLUS ACTION, AND GRAPHICS

The Dazzler™ maps your computer memory content onto your color tv screen in full color.

That doesn't mean just that you see alphanumerics in color. You can display *any* information in memory. And do so in color.

NEEDS ONLY 2K MEMORY

Technically, the Dazzler™ scans your computer memory using direct-memory access (DMA). It formats each memory bit into a point on the tv screen to give a 128 x 128-element picture. Only a 2K-byte computer memory is required (only 512 bytes for a 32 x 32 picture). The quality of the pictures is evident in the photos.

The Dazzler™ output is a video signal that goes directly to the tv video amp or to the antenna terminal through an inexpensive commercially-available device.

INEXPENSIVE — AND SO MUCH BETTER

You can see from the list below that the Dazzler™ is little if any more in price than an ordinary b/w interface or tv typewriter. But it does much more.

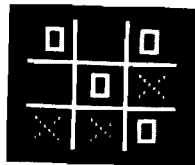

Sequence from Cromemco's TIC-TAC-TOE software which lets you play the computer. Don't be sure you'll always win—we've made it rough.



Sequence from Cromemco's KALEIDOSCOPE software. This program runs without keyboard entry, gives you stunning color display.



Example using Cromemco's DAZZLE-MATION software. A second tape ("Magenta Martini") was used to obtain above action display. This tape is included with DAZZLE-MATION as a use example.

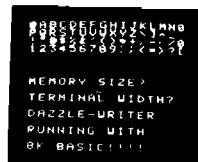

Top four lines show range and style of alphanumerics obtainable with Cromemco's DAZZLE-WRITER software. Query lines are first two prompts from MITS BASIC.

TECHNICAL SPECIFICATIONS DAZZLER

DISPLAY FORMAT: 128 x 128, 64 x 64, or 32 x 32 (software selectable).

COLORS AVAILABLE (COLOR MODE): Red, green, blue, cyan, magenta, yellow, white, black.

GRAY-SCALE AVAILABLE (B&W MODE): 16 intensities.

SYSTEM MEMORY REQUIRED: 2K bytes (512 bytes for low resolution mode).

MEMORY ACCESS: DMA.

DMA RATE: 1 Megabyte/second.

VIDEO OUTPUT: Composite video TV signal.

BUS: S-100 (two slots required).

POWER REQUIREMENTS: +8 volts @ 1.4 A
-18 volts @ 50 mA

OPERATING ENVIRONMENT: 0 - 55°C.

DAZZLER SOFTWARE

(punched paper tape with documentation)

If you're into computer (or want to be), if you want to invent these beautiful displays or games, or to plot colorful material inexpensively at home or in business, the Dazzler™ is for you.

Not only is it reasonable, but it's sold at computer stores from coast to coast.

Or order directly by mail on your bank card.

PRICES

TV DAZZLER kit (model CGI-K)	\$215
TV DAZZLER assembled (model CGI-W)	\$350
LIFE in full color	\$15
KALEIDOSCOPE in full color	\$15

DAZZLE-WRITER (for alphanumeric displays in color)	\$15
DAZZLE-MATION (for computer-generated animated displays)	\$15
TIC-TAC-TOE (you play the computer)	\$15
SPACE WAR	\$15
4D TIC-TAC-TOE	\$15
TANK WAR	\$15
CHASE	\$15
TRACK	\$15
DAZZLE-DOODLE	\$15
GOTCHA	\$15

Catalog Order No. CGI-K
TV Dazzler Kit.....\$ 215.00

Catalog Order No. CGI-W
TV Dazzler Assembled.....\$ 350.00

Joystick console with speaker

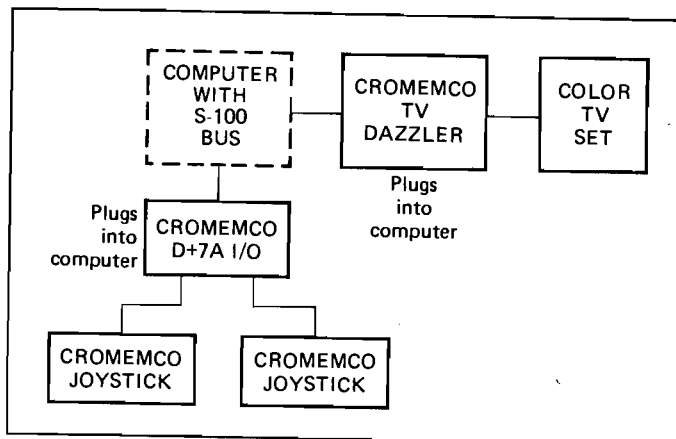
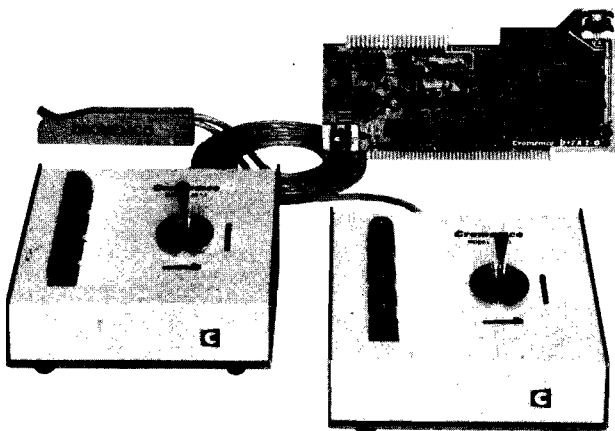

AND THERE'S AN EASY WAY TO INPUT IT TO YOUR COMPUTER

You'll get a lot more fun out of your computer with this new joystick.

But note that it is not just an ordinary joystick — it is a console. It has a 2-axis joystick and contains a speaker and speaker amplifier. You can have sound with your games or, say, warning sounds in other applications. Or have your computer talk to you.

Gives you sound, too



Four pushbuttons

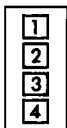

A third feature you get is four pushbutton switches. These give you even more possible uses such as selecting various colors on a color graphics terminal.

EASY TO COUPLE

To couple the new joystick to your computer, just use our D+7A™ I/O board. It will couple not only one but two consoles to your Altair™ 8800 or IMSAI 8080. And you'll still have several analog channels left over (and one 8-bit output port).

The D+7A plugs into the Standard 100 (S-100) bus of your Altair or IMSAI computer.

NEW SOFTWARE

Here's some new Cromemco software for the joystick (to display, use DAZZLER interface):

SPACEWAR (2 players, 2 joysticks): this famous game is available for the first time for a microcomputer.

TANK WAR (2 persons, 2 joysticks): maneuver your tank while firing missiles at your opponent. Sound effects add to the excitement.

CHASE! (2 persons, 2 joysticks): the cross chases the circle.

TRACK (1 person, 1 joystick): move the dot to the center of the spiral without touching the spiral's arms.

DAZZLE DOODLE (1 person, 1 joystick): lets you draw pictures in 4 colors on your color TV terminal using the joystick.

EASY TO DISPLAY

Displaying the joystick outputs with the software below is also easy. Just use our TV DAZZLER™ board. It also plugs into the S-100 bus.

TECHNICAL SPECIFICATIONS JS-1 JOYSTICK CONSOLE

JOYSTICK:

Degrees of freedom: 2 axes (X and Y), spring return to center.
 X axis output voltage: ±2 volts, center 0 volts.
 Y axis output voltage: ±2 volts, center 0 volts.

SWITCHES:

Number of switches: 4
 Output switch depressed: 0 volts
 Output switch open: +5 volts

AMPLIFIER/SPEAKER:

Input voltage range: -2.56 to +2.54 volts
 Output: 47-ohm internal speaker

GENERAL INFORMATION:

S-100 bus interface: use Cromemco D+7A I/O.
 Power requirements: +5 volts @ 50 mA
 +18 volts @ 40 mA
 -18 volts @ 40 mA
 Operating environment: 0 - 55°C

Catalog Order No. JS-1K
 Joystick Console Kit.....\$ 65.00

Catalog Order No. JS-1W
 Joystick Console Assembled...\$ 95.00

Software

CROMEMCO FORTRAN IV

Cromemco's FORTRAN package provides new capabilities for users of Z-80 based microcomputer systems. Cromemco FORTRAN is comparable to FORTRAN compilers on large main frames and mini computers. It includes all of ANSI standard FORTRAN X3.9-1966, except for double precision and complex data types. Therefore, users can take advantage of the large number of applications already written in FORTRAN.

Cromemco FORTRAN operates as part of CDOS, the Cromemco disk operating system.

RELOCATABLE CODE AND LIBRARY FEATURES

Cromemco FORTRAN provides a microprocessor FORTRAN and assembly language development package that generates relocatable object modules. This means that only the subroutines and system routines required to run Cromemco FORTRAN programs are loaded before execution. Subroutines can be placed in a system library so that the user can develop a common set of subroutines which are used in his programs. Also, if the user changes only one module of his program, he need re-compile only that module.

Z-80 MACRO ASSEMBLER AND LINKING LOADER

The relocating assembler has MACRO capabilities. It uses Z-80 mnemonics but is compatible with 8080 mnemonics using a translator program provided with the Assembler package.

A unique feature of the assembler lets the assembly language programmer define and reference FORTRAN COMMON blocks. The assembler uses approximately 5K of memory.

LINK, the relocating loader, resolves internal and external references between the object modules loaded. LINK also performs library searches for system subroutines, and generates a load map of memory showing the locations of the main program, subroutines and COMMON areas. LINK requires 2K of memory.

CROMEMCO 16K Z-80 BASIC

Cromemco's new 16K BASIC is one of the fastest and most capable available. It has extended string handling capability, PRINT USING, TRACE, integer, single and double precision formats (BCD format is used to prevent conversion errors).

This powerful version of BASIC

ordinary joystick — it is a console. It has a 2-axis joystick and contains a speaker and speaker amplifier. You can have sound with your games or, say, warning sounds in other applications. Or have your computer talk to you.

Gives you sound, too



A third feature you get is four pushbutton

• **BASIC.** Cromemco 3K Control BASIC is a compact integer-only BASIC interpreter designed specifically for microcomputer control applications. Control BASIC allows the user to read and write specific memory and I/O locations and call machine language subroutines. There are 36 commands and functions available:

CALL	NEXT	TO
EPROM	NULL	WIDTH
FOR	OUT	ABS
GOTO	PRINT	AND
GOSUB	PUT	GET
IF	QUIT	IN
INPUT	RETURN	LOC
LET	REMARK	OR
LIST	RUN	RND
LOAD	SAVE	SIZE
LOCK	STEP	SGN
NEW	STOP	XOR

Control BASIC requires 3K of memory space beginning at location E400. It is available on paper tape (Model CB-PT) or in 3 2708 PROMs (Model CB-308).

• **MONITOR.** The Cromemco Z-80 Monitor is a powerful tool for use in software development. It allows the user to examine and alter register and memory contents, set program break points, move blocks of memory, program PROMs (using the Cromemco BYTESAVER), and read and punch paper tapes — all under keyboard control.

There are 12 Monitor commands:

DSPM	READ	MOV
DSPR	WRIT	OUT
SUBM	GO	PRGM
SUBR	GO (breakpoints)	VERFY

The Monitor resides in memory space from E000 to E3FF and is available on either paper tape (Model ZM-PT) or in one 2708 PROM (Model ZM-108). Model ZM-PT paper tape. \$15
Model ZM-108 in 2708 PROM. . . \$50

• **ASSEMBLER/RESIDENT OPERATING SYSTEM.** The Cromemco assembler and resident operating system allows the user to create and edit Z-80 source code, assemble the source code, and create object code files.

There are 43 operating system commands:

CFIL	NFOR	WBIN	ENTE	PSTA
LFIL	AUTO	RBIN	MOVE	STAB
CURR	RENU	WCBN	VMEM	ASMB
DFIL	DELE	ECBN	PRAM	ASMC
VFIL	LIOD	RCRN	BANK	ASMU
MFIL	IODR	WCHX	ECUS	EXEC
LIST	DIOD	ECHX	LCUS	PROM
TEXT	SYSI	RCHX	DCUS	
FORM	LEAD	DUMP	RENA	

The assembler/resident operating system resides in memory space from address A000 to BFFF. It is available on paper tape (Model ZA-PT) or in 8 2708 PROMs (Model ZA-808).

Catalog Order No. FDF-S

Fortran IV on 5" disk.....\$ 95.00

Catalog Order No. FDF-L

Fortran IV on 8" disk.....\$ 95.00

Catalog Order No. FDA-S

Z-80 Assembler on 5" disk....\$ 95.00

Catalog Order No. FDA-L

Z-80 Assembler on 8" disk....\$ 95.00

Catalog Order No. 16KB-PT

16K BASIC on paper tape.....\$ 75.00

Catalog Order No. 16KB-1608

16K BASIC on PROM.....\$800.00

Catalog Order No. FDB-S

16K BASIC on 5" disk.....\$ 95.00

Catalog Order No. FDB-L

16K BASIC on 8" disk\$ 95.00

Catalog Order No. CB-PT

Control BASIC on paper tape..\$ 15.00

Catalog Order No. CB-308

Control BASIC on 2708 PROM...\$150.00

Catalog Order No. ZM-PT

Monitor on paper tape.....\$ 15.00

Catalog Order No. ZM-108

Monitor on 2708 PROM.....\$ 50.00

Catalog Order No. ZA-PT

Assembler O/S on paper tape..\$ 30.00

Catalog Order No. ZA-808

Assembler O/S on 2708 PROM...\$900.00

Catalog Order No. FDG-S

Dazzler Games on 5" disk.....\$ 95.00

Catalog Order No. FDG-L

Dazzler Games on 8" disk.....\$ 95.00

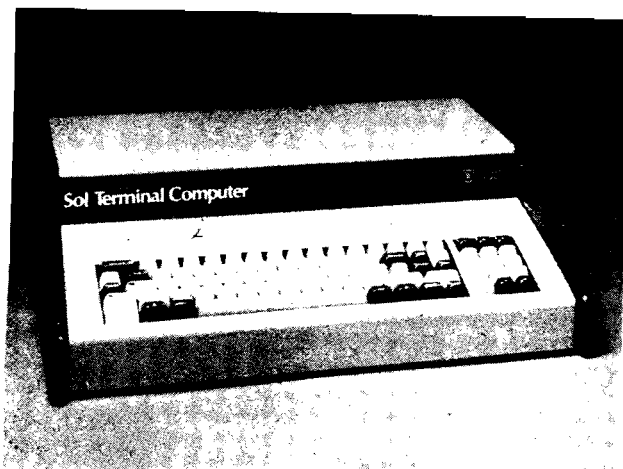

The new Sol-20 is unique. It's the first small computer designed as a complete system. Most small computers simply "grew like Topsy"—a memory here, an expansion module there. They weren't conceived or integrated to provide maximum efficiency at lowest possible cost.

Sol-20, a true breakthrough in small computer systems, includes all the essential elements as standard equipment—central processor, memory, keyboard and display, software, a power supply, and appropriate packaging. There are no "surprises". You don't have to buy expensive peripheral equipment to make it run. Its own keyboard and "smart" terminal are built-in.

Use it without being a programming expert. In fact, you can operate it efficiently without any prior computer experience. Unlike other small computers, Sol is already programmed to receive your commands the moment it's turned on, thanks to Sol plug-in Personality Modules.

And Sol systems are supported in depth by extensive software and additional peripherals—such as flexible disk memories—so it's appropriate for more sophisticated applications. Sol computer systems never grow old. Add new modules to update and expand your computer's power.

Sol is easy to use. Sol operates like a typewriter so many applications require no special programming. Packaged in handsome cases with solid walnut sides, Sol computers look good in the living room, office or lab. Sol computers come in kit or fully assembled form.

Sol-20 is a scaled-down big computer system. Use Sol in a variety of applications.

In the home. Home uses are limited only by your imagination. Regulate heat and light to save fuel. Run a complex model railroad. Compute taxes. Play a variety of TV games, not only computer hockey and tennis, but more interesting, more complex games such as TREK-80, where your starship takes on a whole fleet of Klingons. Several sophisticated TV games come with the Sol-20. And you can even design your own.

At the office. Use it as a fullfledged business computer. Use it to compose and edit letters electronically, store and retrieve mailing lists,

process orders, maintain journals and general ledgers, and produce statements and reports.

In the lab. Use Sol to reduce and analyze data statistically, control lab equipment, prepare graphics, and fit curves. Sol-20 frees your time and expands your overall capability.

In schools and universities. Use Sol-20 to teach computer programming. Use it for computer-aided instruction. Use it for notes, records and sorting.

So much is standard. Here's the computer with a microprocessor, display and input/output circuitry, memory, full alpha-numeric keyboard, big power supply, handsome cabinet, and software.

Add extras for more power. Extras include a module to help write, edit, assemble, de-bug and run your own programs. There's no better collection of add-on memories anywhere...up to 16,384 words per module. Solve additional interfacing problems with our I/O module. Get big system performance with our Helios II "floppy" disk system. Display results on our video monitor. Output on line or serial printer.

1. SOL COMPUTERS

Sol computers are currently offered in two forms: the Sol-20 and the Sol PC.

A. The Sol-20 Stand Alone Computer

Sol-20 is the most complete and sophisticated of the three packages, a fully contained "personal" computer able to take on an infinite variety of tasks. Sol-20 comes with:

- 8080 microprocessor, still the most sophisticated computer-on-a-chip available and the "brains" of the Sol-20.
- 1024-character video display circuitry. View your output on any standard video monitor or specially adapted TV.
- 1024 words of static low-power read/write memory (RAM) for program storage.
- 1024 words of static low-power, preprogrammed permanent memory (ROM) takes care of important system "housekeeping" chores. ROM memory automatically readies the computer for your commands as soon as the Sol is turned on.
- A custom designed, beautifully laid-out 85-key solid-state upper and lower case keyboard with cursor keys and arithmetic keypad.
- An audio cassette interface capable of controlling two recorders at 1200 bits per second. Store and retrieve programs and large amounts of data at very low cost.
- Both parallel and serial standardized interfaces with connectors on card.
- A complete rugged power supply and quiet cooling fan.
- A handsome case of walnut and metal.
- Software including a preprogrammed PROM personality module and a cassette with BASIC-5 language, plus two sophisticated computer video games.

- A design compatible with all S-100 bus products.
- A back plane capable of accepting five expansion modules.

B. Sol-PC Single Board Terminal Computer

Here's the heart of the Sol system. The Sol-PC is a single printed circuit board with microprocessor, memory, display and interface electronics, and plug-in personality module that is fully compatible with our complete line of memory and interface modules. The board comes in kit or fully assembled form with all of the following:

- Display: 16 lines of 64 characters per line.
- Character set: 96 printable ASCII upper and lower case characters plus 32 selectable control characters.
- Cursor: selectable blinking. Solid video inversion. Programmable positioning standard.
- Serial interface: RS-232 and 20mA current loop, 75 to 9600 baud, asynchronous. 25 pin female "D-type" connector on card.
- Parallel interface: eight data bits for input and output; output bus is tristate for bidirectional interfaces; levels are standard TTL. 25 pin male "D-type" connector on card.
- Keyboard interface: seven-level ASCII encoded, TTL levels.
- Microprocessor: 8080, 8080A, or 9080A.
- On-card memory: 1024 bytes PROM (expandable to 2048 bytes); 2048 bytes low-power static RAM.
- External memory: expandable to 65,536 bytes total ROM, PROM and RAM.
- Video signal output: 1.0 to 2.5 volts peak-to-peak. Nominal bandwidth is 7MHz. Power required ($\pm 5\%$): +5 volts at 2.5 amperes, +11 volts

II. PERSONALITY MODULE

The SOLOS Personality Module optimizes the Sol for stand-alone computer applications. The SOLOS allows you to use your Sol system to store and retrieve business or personal records, control electronic instruments, perform independent calculations for business, science or education, or any other application where the Sol system will be "on its own" operating independently of other computers.

SOLOS is oriented around use of the Sol's built-in CUTS audio cassette data interface. Programs such as Sol-BASIC and ALS-8 can make extensive use of the cassette handling and screen-cursor manipulation routines contained in SOLOS. Commands included are: Dump, Enter, Execute Terminal (i.e. enter Terminal mode), Tape Load (reads CUTS format cassette tapes into memory), Tape Save (stores memory contents on CUTS tape) and

Set I/O (permits dynamic switching of input and output devices under manual or program control). With SOLOS the Sol can also be used as a "smart" terminal in conjunction with other computer systems.

III. SOFTWARE

Software is the sine qua non of any computer system. It's the computer power essential.

No computer can be more powerful than the software that goes with it.

That's exactly why Processor Technology has devoted more effort to the development of software than other small computer makers. Maybe that's why some of their worthy competitors have taken their source listings, added a few twists and taken title. But the truth will out.

All Sol systems software is designed to make full use of the routines and programs permanently stored in the Sol personality module. User programs such as BASIC require less memory space, because personality module routines are called up whenever needed for functions such as keyboard input, screen formatting, and cassette tape storage operations. Interface with the user is straightforward and consistent because keyboard commands and control sequences are standardized for all Sol software.

A. SOL BASIC

Processor technology offers three versions of BASIC language, each suited to a different application. BASIC-5 is a small version of this versatile language designed for applications requiring just mathematical manipulation without extensive processing of text. BASIC-5 is the perfect language for an introduction to computer programming because it's easy to learn and requires a small amount of memory storage. Many hundreds of programs already written in BASIC work with Sol BASIC-5 AND OUR 8K BASIC as well.

Processor Technology 8K BASIC is a very high speed full function language with all the virtues of BASIC-5's multiple program capability and BCD floating point math. Speed is at least double that of the already fast BASIC-5. For even greater power, they've added strings, multi-dimensional arrays and multi-line, multi-variable, user functions.

Here's the language for full capability systems. For instance, in their instruction manual, take a look at the Business analysis program. See how you get more power while using less memory for the working program.

Processor Technology 8K BASIC offers several unique and unusual features. Versatile print statements provide fully formatted output to multiple devices, from CRT screen to teletype to line printer. Multi-dimensional arrays permit powerful fast processing of any data that can be organized graphically or in tabular form. Several statements are provided to give complete and direct high level language control over system memory and input/output channels. Full capability string

functions simplify manipulation and processing of text and alphabetic materials so they are more straightforward and easy to use than ever before. In short, with this BASIC, no effort has been spared to bring you high level problem solving power.

Extended Disk BASIC has all the powerful features of the 8K memory-resident version and includes disk commands and big system file handling capability. Disk BASIC is perfect for such complex applications as inventory control and payables-receivables accounting.

BASIC CHART

Commands:		BASIC-5	8K BASIC	Extended Disk BASIC
ASAVE	ASCII DISK SAVE			+
CONT	Continue		+	+
CLEAR		+	+	+
GET	tape or disk	+	+	+
KILL	delete file			+
LIST		+	+	+
MEM	multiple programs	+	+	+
NULL	for printers	+	+	+
RESAVE				+
RNUM	Renumber		+	+
RUN		+	+	+
SAVE	tape or disk	+	+	+
SCR	Scratch	+	+	+
XEQ	Get + Run	+	+	+
Statements:				
CALL	call machine subroutine	+	+	+
CLEAR			+	+
CLOSE	disk file			+
DATA		+	+	+
DEF	define function		+	+
DIM(X)		+	+	+
DIM(X,Y,Z,)			+	+
ELSE	if,then,else		+	+
END		+	+	+
EXAM	memory "dump"		+	+
EXIT		+	+	+
FILL	"deposit" memory		+	+
FOR ... NEXT		+	+	+
FREE	free space		+	+
GOSUB		+	+	+
GOTO		+	+	+
IF ... THEN		+	+	+

B. THE ALS-8 PROGRAM DEVELOPMENT SYSTEM

Applications with very high speed data manipulations or critical timing elements demand "custom fit" programs and subroutines. High level languages written for microprocessors such as FOCAL, BASIC, or FORTRAN cannot always handle these assignments. In these cases the best solution

INP(X),Y	from inport x		+	+
INPUT		+	+	+
INPUT," "	suppress CRLF	+	+	+
LET		+	+	+
ON	ON ... GOSUB		+	+
OPEN	disk file			+
OUT(N),	to out port N		+	+
PAUSE			+	+
PRINT		+	+	+
PRINT USING			+	+
READ		+	+	+
READ#N	read file	+	+	+
REM		+	+	+
RESTORE		+	+	+
RESTORE	with line #		+	+
RETURN		+	+	+
REWIND	rewind file pointer			+
SET I/O	for peripherals	+	+	+
STOP		+	+	+
WAIT	for input port bit(s)		+	+
WRITE	disk			+
BASIC Functions		BASIC-5	8K BASIC	DISK
ABS	absolute value	+	+	+
ARG	16 bit conversion	+	+	+
ASC	ASCII value		+	+
ATN	Arctangent		+	+
CHR	Decimal value of character		+	+
COS	Cosine	+	+	+
EOF	End of file			+
EXP	e ^x		+	+
INT	Integer	+	+	+
LEN	String length		+	+
LOG	Natural logarithm		+	+
LOG10	LOG base 10		+	+
RND	Random number	+	+	+
SEARCH	Search string for string		+	+
SGN	Sign of number	+	+	+
SIN	Sine	+	+	+
SQR	Square root	+	+	+
STR	Convert no. to string		+	+
TAB	PrintTAB(X)	+	+	+
TAN	Tangent	+	+	+
VAL	Convert string to no.		+	+

is programs written in assembly language, a language much more closely related to actual real-time computer operations. Assembly language is easy to learn and, with either of their two assemblers, quite easy to use.

To simplify the development process both Processor Technology assembler programs organize user programs as files. Processor Technology's much imitated Software #1 package is a small assembler-

monitor system designed for development of small to medium length programs which must be stored in system RAM memory for assembly. The ALS-8 is a more versatile and expanded development package with many additional powerful features.

With the ALS-8 up to six source programs can be stored in memory as named files and called at will to be listed, edited, assembled or simulated. Files may also be stored on tape or disk and can be assembled from any selected input device. Files can be appended, moved, re-numbered, taken apart or linked together. Using the FCHK command, crashed files can be restored.

Assembly language source programs are entered using line numbers from paper or mag tape, keyboard, or disk. All editing is done by line number but with the TXT-2 Text Editing software, it becomes possible to automatically add line numbers to unnumbered text.

The Assembler includes labels, comments, expressions and constants, along with relative symbolic addressing, which gives you the ability to chain common symbols from one program to another (even if the other program was assembled at some other time). Also, various assembly error messages are provided to help you eliminate program bugs.

C. ALS-8, A powerful, new development procedure

ALS-8 has the unusual ability to dynamically adjust the system's I/O handling configuration. The system includes an I/O driver table accessible through use of three resident commands or the drivers themselves on and off or transfer I/O control to a different device driver under program control.

Your development system might have a CRT terminal, a high speed line printer, paper tape reader/punch and a teletype. The System can print a listing to the line printer, then input from the paper tape reader and return console control to the CRT terminal or teletype, all under program control.

Up to 20 custom commands can be entered by user and called in exactly the same way as the standard resident commands. With the custom commands, I/O driver table, dynamic I/O switching capability and common symbol tables, you can change your system's configuration and operating modes at any time.

Resident commands are:

ASSM	CUST	ENR	FIND	MOVE	SYME
ASSME	CUSTD	EXEC	FMOV	NFOR	SYML
ASSMI	CUSTE	FCHK	FORM	SIMU	SYSIO
ASSMX	DUMP	FILE	IODR	STAB	SWCH
AUTO	EDIT	FILES	LIST	SYMD	TEXT

Custom commands: Up to 20 specified by the user.

The ALS-8 requires 2048 bytes of random access memory (4096 is recommended) for symbol tables and system global area, addressed at D000 (hexidecimal).

D. SIM-I

The SIM-I Interpretive Simulator is a program that actually thinks it's an 8080! With the SIM-I/ALS-8 combination, simulate 8080 programs on your Sol, IMSAI, or Altair computer without actually running them in real-time. All registers, flags, program counter, and stack are simulated. Try out programs with no fear of crashing your system if something goes wrong. The system doesn't lose control if a program error is encountered (e.g., an incorrect jump or call).

With SIM-I, you can set breakpoints, enable or disable register/memory content printout. I/O instructions can be run in real-time simulated from the system console or set to predetermined values for any I/O port address.

SIM-I is a powerful de-bugging tool for 8080 programming.

E. TXT-2, Text Editor

Adds the world of text editing to your system. Using TXT-2, insert, delete and move single characters, entire lines or portions of lines. Complete text files can be scanned at several user controlled rates, up to almost 2000 lines per minute when used with our VDM-I Video Display Module.

Both ALS-8 and Software #1 packages are available on "CUTS" 1200 bps cassette or paper tape. The ALS-8 is also available preprogrammed into permanent ROM memory to provide "Instant-on" efficiency and speed.

F. TREK 80

Based on the NBC television series STARTREK, this machine language program uses 8K of memory and the VDM graphics capability for real-time war with the Klingons. No holds barred, they're out to get you from each of the 100 quadrants. You can warp through hyperspace, fire phasers, photon torpedos or experimental rays, or if you just can't go on, self-destruct. TREK 80 resides and runs in 8K of memory and, if not used with a Sol, requires a Processor Technology VDM-I Video Display Module.

G. NEW 8080 FOCAL ("DEC")

FOCAL is a high level math language originally written for the PDP-8 minicomputer. Many thousands of FOCAL programs are in existence and now they can run in the Sol. The original 8080 FOCAL has been updated to include operator precedence and all other standard FOCAL conventions. It also has a driver for VDM-I or Sol displays and CUTS cassette program save and load. FOCAL is available only on CUTS 1200 bps Cassette and resides in 8K of memory.

H. GAMEPAC I

Show off your Sol system with this line up of video games. Each is included on the CUTS cassette or paper tape.

TARGET-Keeps track of your hits and misses while you blast away at the numerous flying

objects. Includes sound effects. You and your family will spend whole evenings at a time with this one.

ZING-Learn hexadecimal arithmetic fast with this video game as two players keep the five balls in the air. If both of you get too good...ZING of course, makes it harder.

LIFE-The Sol or VDM-I make a good display for the game of LIFE and this version allows two modes of operation. The universe can be flat or wrapped around on itself. The real meaning of life we'll leave to you, but it's fun to watch.

PATTERN-We haven't figured this one out ourselves, but it's sure fun to have your computer doing it. You choose the geometric design and how rapidly it changes. The computer dazzles you with its artistic genius.

All Processor Technology software is distributed on an individual sale basis for personal use. No license to copy, duplicate or sell is granted with this sale. Each software package has been copyrighted.

IV. MEMORIES

As your computing needs grow you will inevitably need more memory for storage of larger programs. Processor Technology offers one of the most complete lines of memory modules for small computers available. Choose either the 4096 word or the 8192 word static read/write memories in kit or assembled form. Or add the completely assembled 16,384 word dynamic module. A 2K erasable PROM module for permanent storage is available in kit or assembled form. A powerful software development tool, the ALS-8 firmware module, with its optional firmware SIM-I and TXT-2, gives you the power to write, edit, assemble, debug and run your own programs the moment power is turned on.

All Processor Technology memory modules include their exclusive "Phantom Disable" feature which is necessary for proper power-on operation of the Sol mainframe. The ALS-8 firmware module also generates this signal as an option when used in Altair or IMSAI computers.

Now you can have fast static random access memories with 4K and 8K capacity with all the bells, whistles you need plus Processor Technology quality.

A. The 4KRA Static Memory Module

Here's a 4096 word read/write static memory which gives you better operation for lower cost than any other 4K memory on the market today. Run it at max MPU speed all the time.

Processor Technology uses only low power static RAM Integrated circuits. So you know you're getting outstanding reliability.

In fact our module draws so little power, you can use standard "D" cells to give you long term back up data retention. We've even built in a battery connector, and recharge circuitry.

B. The 8KRA Static Memory

PT's 8K memory gives you all the advantages of their 4K with twice the capacity and more flexible addressing circuitry. The 8KRA uses less power than two 4KRA memories.

All address and data lines are fully buffered. Noise immunity circuitry is builtin. The 8KRA has PT's exclusive built-in KSET switch giving you card address offset in 1K increments. Address is set by a dual inline switch easily accessible at the top of the PC board.

Each IC—all 76 of them—has its own top quality IC socket so that assembly, test and repairs are far easier.

C. 16KRA Memory

Fully burned in, tested and assembled, PT's new 16,384 byte memory offers a better price performance ratio than anything remotely comparable. It's the quality, reliable low-cost way to add high density memory to your system. Every board is "burned in" at high temperature for twelve hours before test to insure reliability in the field.

This PT memory offers invisible refresh. There's no waiting while the CPU is running. Worst case access time is 400 nsec. Each 4096 word block is independently addressable for maximum system flexibility. Power is typically 5 watts, the same as most single 4K memory modules. It's got back-up battery capability built-in.

D. 2KRO Erasable Programmable Memory

Accepts up to 2048 bytes erasable programmable read-only memory. Stores data even when power is off. Great for your custom loader or monitor programs.

The 2KRO is jumper selectable to fit any one of thirty-two 2K segments within the 65K addressing range of the 8080. Additional jumpers select the appropriate number of "wait" states, determined by the access time of the EPROMs in use.

The 2KRO was designed for either the I702A or MM5203 EPROMS. EPROMS are not included, but both are readily obtainable for reasonable prices on the industrial and surplus markets.

E. The ALS Firmware Module for fast software development

The ALS-8 is a low power "turn-on-the-switch" program developer. Quickly write, edit, assemble, de-bug and run your own programs. Here's an easy to use, easy to understand software development tool you can begin to use with only 15 minutes instruction.

Two firmware options are available, the SIM-I Interpretive Simulator, a program that thinks its an 8080, and TXT-2 text editing firmware which adds the world of text editing to your system.

PTC MEMORY MODULES

	4 KRA	8 KRA	16 KRA	2 KRO	GPM/ALS-8
Maximum Capacity (8-bit words)	4096	8192	16,384	2048	5120 to 8192 bytes ROM
RAMS used	91L02A or 2102LPC	91L02A or 2102LPC	Intel 2104 or Mostek 4096 types	1702A EPROM	9216B ROM
Operating Mode	Static	Static	Dynamic	Static	Static
Access and Cycle Time	520 nanoseconds worst case maximum. Typical 400 nanoseconds.	Same	400 nsec access 500 nsec cycle	Dependent on EPROM used. Works over range of 30 to 2500 nsec	450 nsec
Bus Pinout	Plug in compatible with Sol, Altair 8800 and IMSAI 8080 bus	Same	Same	Same	Same
Power: Operating	+7.5 to 10 VDC @ 1.0A max (0°C), 0.8A typical at 25°C. 0.8A typical, 1A max.	+7.5 to +10 VDC at 1.4A typical (25°C); 1.9A max (0°C to 70°C)	+7.5 to 10 VDC @ 0.4A typical, 0.8A max. +15 to +18 @ 100mA typical, 150mA max. -15 to -18 VDC @ 20mA max.	+8 to +10 VDC @ 0.6 max. -15 to -19 VDC @ 350mA max with 8 1702As installed. (Replacement transformer available for full negative supply in Altair 8800)	+7.5 to +10 VDC @ 600 max. +14 to 19 VDC @ 200mA max. (with SIM-1 and TXT-2 options installed)
Power: Standby	+1.6 to 2.5 VDC at 0.5A max worst case. 0.4A typical	+1.6v to 2.5 VDC typical; 0.9A max (power connector provided for battery connection)			
Address Selection	Dual in line switches	Dual inline switch at top of PC board allows manual selection of any 8K segment on 1K increments	Each 4096 byte page addressable with dual in line switches at top edge of PC board	Jumper selectable to any 2048 byte block of the 32 available.	Fixed at E000 to FFFF (hex)
Dimensions	5.3"x 10.0" (13.46 cm x 25.4 cm)	5.4"x 10.0"	5.4"x 10.0"	5.3"x 10.0"	5.3"x 10.0"
Phantom RAM (for Sol and ALS-8)	Yes	Yes	Yes	No	Yes

V. DISK STORAGE

A. Disk Storage

Every computer owner longs for all the advantages of fast random access memory. We're ready when you are to put big system disk memory power at your command. The new Helios II is more than just a floppy disk drive and controller. It's more than just scattered pieces of wire and patches of software. Helios II is a complete, integrated disk storage system which should meet every program and data storage requirement your system is likely to have. The Sol-Helios pair forms a cost effective, high performance system without equal.

Big system performance is unique to the Helios II. Used in any application requiring manipulation of large data files, Helios II will outperform all other microprocessor based systems by a factor of at least 10 to 1.

Big system performance means extended DISK BASIC, DISK FOCAL, and Processor Technology software support. DISK FOCAL is provided free on the system diskette and extended DISK BASIC is offered on a separate diskette. Using these simple languages you can immediately write programs for any application you have in mind. The file operations include random byte or block access as well as update and rewrite in place of

standard sequential files. Other application packages are under continuous development at Processor Technology. And in line with PT basic software philosophy, each will reach the market at the lowest possible cost.

Helios II comes complete with dual drive, controller, system diskette with DOS, power supply, case, all necessary cables and full systems documentation. A 12K assembly language program to test and report on every aspect of your unit is included too.

Helios II loads an 8000 byte program with a look up in the system directory in 0.3 sec., a speed which becomes truly significant when you are working on two 100K source files to create a third, adding up to a total of 200,000 bytes.

Big system performance means all disk and memory buffer space allocation, all file management, all device interaction, comes from the system.

"Firm sectored" Controller raises disk storage to 386,000 bytes per diskette.

The Helios controller is a genuine performance breakthrough, increasing formatted data capacity per diskette surface to over 386,000 bytes and at the same time assuring higher reliability than the older IBM format. Standard Helios II storage capacity is over 750,000 bytes. With two dual drives, capacity can be doubled to 1.5M bytes.

Asynchronous data transfers are made directly to memory at an effective rate of one-half million bytes per second. A sixteen byte fifo memory accumulates the data to or from the drives, freeing the computer for useful work. A standard hardware CRC error test is performed on each transfer of data and an optional read-after-write verification mode is easily selected. The controller requires at least one S-100 bus slot and is fully compatible with Sol, Altair or IMSAI systems.

No need to buy special, expensive diskettes—the controller will pre-format any standard 32 hole "floppy diskette.

B. Software

Features include:

- Complete management of static, dynamic user buffers.
- Device files for generality of input/output operations.
- System calls for complete file operations from external programs.
- Three level, triple option error handling/trapping.
- Random/Indexed Files for direct positioning to any word of a file, anywhere on the disk(s).
- Command Line Interpreter accepts and executes a string of commands from you or a file.
- System utility call performs a random search to the utility operation of your choice.

Helios II can be configured and reconfigured for any size buffer area. Over 40 files can be open at one time. System calls provide standardized access for all file operations from external programs and routines.

The Command Interpreter accepts input from the current command input file to provide direct file operations from the keyboard or another file. Support program calls are identical to commands but executed outside of the system area (e.g., in low memory).

C. NEW EXTENDED DISK BASIC

Further increasing the value of your Helios II is PT extended DISK BASIC. This powerful language offers advanced string and math functions plus direct commands (SAVE, RESAVE, ASAVE, KILL, AND XEQ) and program statements. DISK BASIC is the only available small computer BASIC with powerful disk file handling commands, statements and functions. These features make complex application programs for inventory control, data reduction and general accounting run ten times more efficiently on the Helios system.

VI. INTERFACES

When Processor Technology talks about making the complete small computer, we mean interfaces, too. Nothing is left out. There's a video display module designed to work with computing equipment you may need. There's a video display module

designed to work with computing equipment you may already have or auxiliary equipment you may need. There's the Computer Users Tape System so you can add additional audio cassette tapes for expanded program and data storage/interchange. There's a wire wrap extender board for anyone who does prototyping. If you're troubleshooting, you can see what you're fixing with Processor Technology's Extender Board. You can handle any additional input/output needs of your system with our 3 P+S Input Output Module.

In sum, Processor Technology has built every basic element you need into Sol for integral operation. And PT has generated the extra equipment for use with peripheral devices or other existing computer you may have. Processor Technology is dedicated to helping you get optimum computer performances.

A. VDM-I VIDEO DISPLAY MODULE

Build a smart terminal into your Altair! Your Altair already has the intelligence, we provide the display module. This is not a limited "TV TYPEWRITER" but an ultra-high speed computer terminal built into your computer. The VDM-I generates sixteen 64 character lines from data stored in the 1K Byte on-card memory. Alphanumeric data is shown in a 7x9 dot matrix with a full 128 upper and lower case ASCII character set. The VDM-I features EIA Video output for any standard video monitor. (A TV set can be easily modified at your local TV repair shop.) Multiple programmable cursors, automatic text scrolling and powerful text editing software are included FREE!

SPECIFICATIONS: VDM-1

CHARACTER SET: 96 character ASCII, plus control characters 7x9 matrix with descending lower case.
DISPLAY FORMAT: 16 lines, 64 characters per line.
DISPLAY MEMORY: 1024 8-bit Bytes LOW POWER Static read/Write memory.
DISPLAY POSITION: Continuously adjustable, horizontally and vertically
I/O, DATA: Addressable as a 1K page of memory, Read or Write.
CURSOR: Solid video inversion (blinking optional) appears at all character positions when bit 7 is high.
I/O, CONTROL: Output from CPU is one 8-bit Byte. The lower four bits control Beginning Line Address; the upper four bits control Beginning Display Offset. Input to CPU is a one bit(DI), Parameter Change Ready flag.
BLANKING CHARACTERS: CR(octal 015) blanks test, except cursor, to end of screen.
SIGNAL OUTPUT: 1.0 to 2.5 VP-P video composite, negative sync.
MONITOR BANDWIDTH: 6.0 MHz (at-3dB) required video BW.

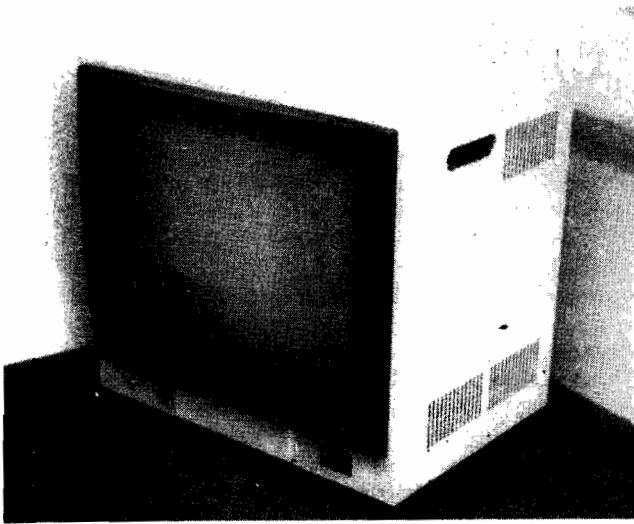

B. 3P+S INPUT/OUTPUT MODULE

Getting data into and out of a computer can be one of the most difficult and expensive tasks in bringing up a working system. Our 3P+S module was designed to provide maximum versatility to allow this one card to meet all the I/O needs of most 8800 system users. For example, one teletype and two TV Typewriters with keyboards can operate simultaneously with the 8800 via one 3P+S module; or, one TV Typewriter, an EIA RS-232 modem, a teletype and another parallel data device can be fully interfaced at the same time.

In addition, one parallel output port is available to be used for setting up control conditions for both parallel and serial ports, as well as to set the serial I/O baud rate under program control. The Baud rate can be set between 35 and 9600 Baud and the module is the only one available that will allow 1.5 stop bits as required by the old model teletypes that are available at such low cost.

Also, one parallel input port is available for polling the Input Data Available flags and External Device Ready flags, as well as for checking the serial I/O error flags. Full handshaking with both input and output peripherals can be implemented with these provisions.

Interfacing to the 8800 vectored interrupt bus is provided on the card as a jumper selectable option, allowing any of the UART (Universal Asynchronous Receiver Transmitter) error flags or handshaking signals to be used to generate interrupts. The Vectored Interrupt Module is required for this purpose.

Addressing of the module is jumper selectable to any one of 64 four address segments within the 8800 range of 256 I/O addresses. Additional flexibility allows either the UART and control port, or the two parallel ports to occupy the lower two relative addresses.

Complete information on each of the options available is included with each 3P+S sold. In addition, a letter to us describing your system configuration will be returned illustrating the best way to implement the system with our module.

SPECIFICATIONS: 3P+S

OUTPUTS: Two 8-bit parallel ports, standard TTL levels, relative addresses at 0 & 1, or 2 & 3.

One Teletype 20mA current loop output.

Four EIA RS-232C outputs for serial transmit data and/or control signals.

One Peripheral Interface Control driver (PIC) 50mA current source for paper tape reader control or cassette recorder control. Jumper selectable to control port output.

INPUTS: Two 8-bit parallel ports, standard TTL voltage levels, input current is 0.36mA max.

One Teletype 20mA current loop receiver for UART data input.

Four EIA RS-232C receivers for received serial data and/or control signals.

I/O CONTROL: One 8-bit output port, relative card address selectable as 0 or 2.

Lower four bits for baud rate control and/or EIA control outputs and/or PIC driver.

Upper four bits for UART control, i.e. word length, parity, and number of stop bits. Control conditions can be strapped on, off or to software controlled, latched output bits.

One 8-bit input port, relative card address selectable as 0 or 2. Bits selectable with jumpers to read UART error flags, i.e. parity, overrun, and framing errors, and/or EIA control inputs, and/or Data Available flags for parallel input ports, and/or External Device Ready flags for parallel output ports.

INTERRUPT CONTROL: Any control input, status flag, or UART output may be jumpered to the Interrupt Bus Driver. Interrupt operation requires use of a Vectored Interrupt Module to gate the Restart instruction to the processor.

BUS PINOUT: Plug-in compatible with Altair 8800 bus.

EDGE CONTACTS: Gold plated, 100 pins (dual 50) on .125" centers.

VOLTAGE REQUIREMENTS: +8 to +10VDC, +15 to +18VDC, -15 to -18VDC.

POWER REQUIREMENTS: 7.0W maximum, 5.5W typical at 25°C

I/O CONNECTION: Two standard 44 pin (dual 22) edge connectors, .156" centers.

DIMENSIONS: 5.0"x10.0" (12.7cm x 25.4cm).

C. WWB—WIRE WRAP BOARD

This is the card for all of you who do wire wrap prototyping. Now you can easily create your own custom interfaces or strange "Kluges" of any kind. The WWB has a "universal" pattern of seven rows of pads on .3" centers, so that standard 14, 16, 24, and 40 pin DIP IC sockets can be plugged in. Power and ground are dedicated to pins 16 and 8 respectively (i.e. for

16 pin DIP's) but the layout is designed for fast conversion of each position to other IC sizes. Up to 62 sixteen pin DIP IC's can be used. An extra six wire wraps socket positions have been set aside for connections to the 8800 bus. Each WWB Kit comes with one 5 volt regulator, a heat sink, and decoupling capacitors. Space is reserved on the card for two more regulators for positive or negative supplies.

Dimensions: 5.3" x 10.0" (13.46 x 25.4 cm)

Contacts: Gold plated, 100 pins (dual 50) on .125" centers

Board Materials: 1/16" G-10 glass-epoxy, plated through holes, 2 oz. copper: solder plated.

EXB — EXTENDER BOARD

This Extender Board makes troubleshooting and servicing of any 8800 compatible module much easier. With the EXB you can plug in a troublesome module five inches above the Mother Board so that both sides of the Board can be reached easily with an oscilloscope, VTVM, or logic probe.

Dimensions: 5.3" x 10.0" (13.46 x 25.4 cm)

Contacts: Gold plated, 100 pins (dual 50) on .125" centers..

Edge Connector: Viking 3VH50/1CV (one included).

VII SUBSYSTEM B.

OWNERS OF ALTAIR , IMSAI , VECTOR INSERT.

With the exception of our own lovable Sol whose original design incorporated a systematic approach to small computer development, all S-100 bus computers demand additional hardware as well as software to get them up and on the air. Without a memory module, the computer cannot handle large amounts of data. Without input/output interfaces, it cannot receive data from a keyboard, transfer information to a TV monitor or teletype printout, or store data on a cassette. Without some elementary software routines built into the system, complex sets of preliminary routines must be entered into the computer before it can coordinate all these activities or load a simple program. In other words, a microcomputer, technological miracle though it is, cannot be useful to any human being without the help of further technological miracles.

In the past, small computer enthusiasts have pieced together their systems purchasing one component here, another there, and then found themselves struggling to make everything work together.

Subsystem B, a contemporary classic from Processor Technology, puts an end to all this

struggle and confusion. In one package, at a remarkably low price, we have included a memory module, three input/output modules, a general purpose memory and appropriate software. For those who prefer the finest craftsmanship over a mess of parts...for those who want the pleasure of running and writing programs without clumsy preliminaries...one modest purchase brings intelligence to the small computer.

Subsystem B offers a choice of three memory modules — 4KRA, 8KRA or 16KRA — with four, eight or sixteen thousand bytes of memory for programs and data. The VDM-1 module interfaces the computer with a TV monitor. The CUTS (the Computer Users Tape System) module interfaces with a cassette recorder for program loading and mass storage of up to 200,000 characters per C-60 cassette. For all other communication to the outside world — keyboard, teletype, printers and so forth — 3P+S provides three ports for data input or output.

The General Purpose Memory (GPM) is a single piece of hardware/software which integrates the functions of all the other modules. The software is preprogrammed onto IC chips and provides instructions to operate the interfaces as well as set up elementary operating commands for the system as a whole which can be entered through a keyboard.

The block diagram on the opposite page shows how a system with a computer and all the Subsystem B components would look.

THE GENERAL PURPOSE MEMORY MAKES IT ALL POSSIBLE.

The above is an insert.

The key concept underlying Subsystem B is inherent in the software which integrates the overall functions of the hardware to create a system that is greater than the sum of its parts. Processor Technology has developed and produced this software as a program called CUTER.

CUTER ties together the internal functions of the central computer as well as a cassette recorder, keyboard, video display and other peripheral equipment. It also brings standard commands to the system such as ENTER, DUMP, GET, EXECUTE and CATALOG as well as custom commands. Furthermore, CUTER makes all Processor Technology and Software Technology programs compatible with the system. CUTER has been preprogrammed in Read Only Memory integrated circuits which reside on the GPM board. It takes up 2,048 bytes of memory space. GPM also has a 1,024 byte area which is used as scratchpad.

Reserved space is available on the GPM board for later addition of a powerful ROM-resident assembler, the ALS-8. To simulate 8080 programs without running them in real time, the SIM-1 interpretive simulator can also be added. For further flexibility, with SIM-1 comes our eminently useful TXT-2 text editor, designed to make file editing quick and easy.

LOAD PROGRAMS AT TEMPO WITH CUTS

For those who are still loading programs via paper tape or flipping switches, CUTS will bring a new tempo to system operations. A cassette recorder with CUTS interface loads programs ten times faster than a TTY paper tape reader. Processor Technology's BASIC-5 program, which is included with CUTS, will load in just 58 seconds. We have also included two popular computer games on this tape.

CUTS is fully compatible with the Byte/Kansas City standard; it will operate at either 300 or 1200 bits per second. Automatic Gain Control eliminates adjustments of the cassette recorder volume or tone controls and minimizes bit drop-out in both read and write modes.

Cassettes simplify data storage because they are compact and can be filed away indefinitely without deterioration. Information can be economically stored and then retrieved quickly.

With CUTS, all Processor Technology and Software Technology programs will run without modification on any S-100 bus computer. CUTS provides the standardization which guarantees availability of an ever increasing selection of compatible software.

HARMONIOUS VIDEO INTERFACE VDM-1

As the original video display interface for S-100 bus systems, VDM-1 is still the most popular. It generates sixteen 64-character lines in a large, easy-to-read, upper and lower case typeface on any standard video monitor or modified TV set.

By utilizing a 1,024 byte segment of system memory, VDM-1 provides extremely fast operation. For example, any character on the screen can be accessed by the processor in microseconds.

Once the processor provides the display status parameters, the VDM-1 can scroll its display upward or downward at a top speed of about 1000 lines per minute.

The VDM-1 is versatile with fully programmable cursor positioning. It will display black-on-white or white-on-black, perfect for many video games. Software is included for terminal mode operation in addition to the CUTER program.

I/O VERSATILITY WITH 3P+S

Virtually all other input/output needs of any S-100 bus computer are handled with ease by the 3P+S module. No need to buy separate interfaces for serial and parallel devices; 3P+S has both.

The serial port has a standard RS-232 interface as well as standard current loop interface for teletypes and various printers. The data rate is selectable up to 9600 baud.

One of the parallel ports sets control conditions for the other ports as well as setting the serial I/O baud rate. Two other 8-bit parallel ports will interface a keyboard or paper tape reader with full handshaking logic.

The extraordinary versatility of the 3P+S module allows it to accommodate virtually any type of peripheral with only minor modifications. The addressing is selectable to any of 64 address segments within the 8080 microprocessor's range of 256 input/output addresses.

RANDOM ACCESS MEMORY: THREE CHOICES

The three versions of Subsystem B differ only in memory capacity. Subsystem B70 includes the 4KRA memory module with 4096 words of read/write static memory. Power drain is so low a standard "D" cell will provide back-up data retention. The 8KRA static memory in Subsystem B110 offers twice the capacity, more address flexibility and even lower power drain than the sum of two 4K memories. It features fully buffered address and data lines, built-in noise immunity circuitry and our exclusive KSET switch to provide card address offset in 1,024 byte increments.

For more programming pleasure, Subsystem B190's 16KRA has 16,384 bytes of dynamic memory. This module is available only in assembled form; fully burned-in and tested, it demonstrates extraordinary reliability. Refresh is invisible, and access is fast, worst case 400 nsec. For all three memory modules, battery connector and recharge circuitry are built-in.

SAVINGS WITH SUBSYSTEM B

The individual modules of Subsystem B can all be purchased separately, but Processor Technology offers a substantial price reduction on the complete package. One box contains all five boards, plus complete assembly and operating instructions. Subsystem B is also available with the modules fully assembled and tested.

	Subsystem		
	B70	B110	B190
MEMORY:			
Ram	4KRA	8KRA	16KRA
Rom + 1K Ram	GPM	GPM	GPM
INTERFACE:			
Cassette	CUTS	CUTS	CUTS
Video	VDM-1	VDM-1	VDM-1
Multi-purpose	3P+S	3P+S	3P+S
SOFTWARE:			
Cassette	BASIC-5	BASIC-5	BASIC-5

OPTIONS: 1. ALS-8 Assembler
2. SIM-1/TXT-2 Simulator/Text Editor (requires ALS-8)

SOL SYSTEM

I. Sol Systems		Order No.	Price
Complete systems are available from Processor Technology to fulfill the application requirements outlined on the Sol Solution Chart in our catalog. These systems include all necessary connecting cables and manuals.			
A. Sol System I includes Sol-20/8 with 8192-byte memory and SOLOS module, PT-872 monitor, RQ-413A cassette recorder, and BASIC 5 tape	Assembled/Tested	400100-01	\$2129
	Kit	400100-02	\$1649
B. Sol System II includes Sol-20/16 with 16,384-byte memory and SOLOS module, PT-872 monitor, RQ-413A cassette recorder, and BASIC 5 tape	Assembled/Tested	400200-01	\$2283
	Kit	400200-02	\$1883
C. Sol System III includes Sol 20/16 with 32,768-byte memory and SOLOS module, Helios II Disk System with DISK BASIC, and PT-872 monitor	Assembled/Tested	400300-01	\$5450
	Kit	400300-02	\$4750
D. Sol-20/8 Terminal Computer with 8KRA 8192-byte Memory Module and SOLOS Personality Module	Assembled/Tested	400400-01	\$1850
	Kit	400400-02	\$1350
E. Sol-20/16 Terminal Computer with 16 KRA 16,384-byte Memory Module and SOLOS Personality module	Assembled/Tested	400500-01	\$1975
	Kit	400500-02	\$1550
II. Sol Components			
A. Sol-PC Single Board Terminal Computer with SOLOS Personality Module	Assembled/Tested	101036-01	\$745
	Kit	101036-02	\$575
B. UGKPC-20 Sol cabinet, 85 key keyboard, fan, power supply and backplane expansion. Upgrades Sol-PC to Sol-20	Kit	101035	\$675
C. Sol-KBD 85-key solid state Keyboard as used in Sol-20 series units	Assembled/Tested	104000	\$230
D. PM 2708 Personality Module for use with 2708 EPROMs (does not include EPROMs)	Assembled/Tested	107000-01	\$40
	Kit	107000-03	\$30
E. SOLOS Personality Module	Assembled/Tested	107000-02	\$90
	Kit	107000-04	\$75
F. 220-Volt Transformer for all Sol-20 series units. Note: All Sol-20 series units and Sol Systems are available for 220 Volt, 50 Hz operation. Contact factory for pricing and delivery information.	Kit	105034	\$50
III. Mass Storage Systems			
Helios II, Model 2 Disk System. Includes dual PerSci 270 floppy disk drive, cabinet, fan, S-100 bus compatible controller, power supply, system diskette with complete PTDOS software	Assembled/Tested	300000-01	\$2695
	Kit	300000-02	\$2395
IV. Subsystem B for all S-100 Bus Mainframes other than Sol			
A. Subsystem B70. Includes 4KRA memory, VDM-1 Video Display Module, 3P + S Parallel, Series I/O Module, CUTS Computer Users Tape System cassette interface and GPM General Purpose Memory Module	Assembled/Tested	406000-01	\$829
	Kit	406000-02	\$594
B. Subsystem B110. Includes 8KRA memory, VDM-1 Video Display Module, 3P + S Parallel, Series I/O Module, CUTS Computer Users Tape System cassette interface and GPM General Purpose Memory Module	Assembled/Tested	406100-01	\$998
	Kit	406100-02	\$730
C. Subsystem B190. Includes 16KRA memory, VDM-1 Video Display Module, 3-P + S Parallel, Series I/O Module, CUTS Computer Users Tape System cassette interface and GPM General Purpose Memory Module	Assembled/Tested	406200-01	\$1095
	Kit	406200-02	\$895

SOL SYSTEM Kits can only be purchased at our Chicago Area Stores. Kit will not be shipped to customer outside the Chicago Metropolitan Area.

V. S-100 Bus Compatible Modules		Order No.	Price
Memory			
A. GPM General Purpose Memory Module with 1024-byte Read/Write memory and 2048-byte CUTER program on ROM	Assembled/Tested	210000-01	\$169
	Kit	210000-02	\$129
B. GPM-Sol. Same as GPM without Read/Write or ROM memory. These memories are included with the Sol.	Assembled/Tested	210000-03	\$119
	Kit	210000-04	\$89
C. ALS-8 ROM Resident Assembly Language Operating System with Interpretive Simulator (SIM-1) and Text Editor (TXT-2). For use with GPM or GPM-Sol. If purchased together, price includes assembly and testing. (ALS-8, SIM-1 and TXT-2 programs are copyrighted.)	Assembled/Tested or Kit	900014	\$190
D. 2 KRO Erasable Programmable Read Only Memory Module	Assembled/Tested	204000-01	\$89
	Kit	204000-02	\$65
E. 4KRA 4096-byte Static Read/Write Memory Module	Assembled/Tested	201000-01	\$150
	Kit	201000-02	\$125
F. 8KRA 8192-word Static Read/Write Memory Module	Assembled/Tested	202000-01	\$250
	Kit	202000-02	\$225
G. 16KRA 16,384-word Dynamic Read/Write Memory Module	Assembled/Tested	203000-01	\$399
	Semikit— assembled & inspected but not tested	203000-03	\$369
Interface Modules			
H. 3P + S Parallel Serial I/O Module	Assembled/Tested	209000-01	\$199
	Kit	209000-02	\$149
I. CUTS Computer Users Tape System cassette interface (includes CUTER tape)	Assembled/Tested	207000-01	\$140
	Kit	207000-02	\$110
J. VDM-1 Video Display Module	Assembled/Tested	208000-01	\$295
	Kit	208000-02	\$199
K. WWB Wirewrap Prototyping Module	Kit	211000-02	\$40
L. EXB Extender Board	Kit	212000-02	\$35
VI. Peripherals			
A. PT-872 TV-Video Monitor by Panasonic		722016	\$199
B. RQ-413A Cassette Recorder by Panasonic		722019	\$85
VII. Software (including manual)	Minimum Memory Required		CUTS cassette
A. BASIC/5	10K	727000	\$14.50
B. 8K BASIC	12K	727017	\$29.00*
C. New 8080 FOCAL	8K	727024	\$14.50*
D. TREK 80 Video Game	8K	727009	\$14.50
E. GAMEPAC:1 Video Games	4K	727006	\$14.50
F. MATHPACK Video calculator	4K	727020	\$14.50
G. ASSEMBLERS: Software #1 Resident Assembler Package	8K	727022	\$14.50
H. ALS-8 Resident Assembler, Simulator and Text Editor	12K	727012	\$35.00
I. Software Technology Music System cassette	8K	727015	\$24.50

Attention

All listed software products require CUTER or SOLOS programs.

All Processor Technology and Software Technology software is distributed on an individual sale basis for personal use.

No license to copy, duplicate or sell is granted with this sale. Each software package has been copyrighted by Processor Technology or Software Technology and all rights therein are reserved.

Prices and specifications are subject to change without notice.



Apple II will change the way you think about computers. Compared to first generation "hobby" computers, Apple II is easier to use, faster, smaller and more powerful. It brings to personal computing a new level of simplicity through hardware and software sophistication. And Apple II can grow with you as your skill and experience grows.

Sophisticated built-in features such as BASIC, the English-like programming language, advanced color graphics, and use of state-of-the-art high density memory components (16K ROMs and RAMs), set Apple II apart from all the others. But you don't even need to know a ROM from a RAM to use and enjoy Apple II. Its beauty is in its simplicity. It's a complete, ready to use computer—not a kit. Everything is included. Hook it up to your color TV and begin writing your own computer programs the very first evening. Even if you've had no previous computer experience, you can invent your own color games, create artistic displays, or instruct Apple II to chart your home finances. Conversing with Apple II in BASIC is easy using its familiar typewriter style keyboard.

Games have always been one of the most creatively challenging applications for the computer, and Apple II's sophistication shows through in the games it can help you create. Games like PONG or STARTREK. Apple BASIC contains advanced unique commands for using color graphics (COLOR=PLOT, HLIN, VLIN, SCRIN) which means creating dazzling color displays or writing your own PONG type game becomes something even a beginner can master.

Since text can be displayed along with graphics, your program can keep score, give and accept instructions and even comment on your ability as a player. Paddles and joysticks are interfaced

easily using the built-in Apple GAME I/O connector. And a special BASIC command (PDL) automatically senses the position of the paddle. That simplifies writing action games. Apple II's built-in speaker sounds when the ball is hit, and when a point is made or lost. In STARTREK, you'll actually hear the phasers and photon torpedoes. Apple II will do more than entertain you. Playing with it, you'll begin to learn what a computer is all about and how rewarding it can be. You'll discover that it's easy to program your Apple II to do things like teach your kids arithmetic or spelling. (Yes, it's OK to let your kids use Apple II. It's ruggedly engineered and has a virtually unbreakable plastic case.) And you can save your programs on an ordinary cassette tape; use the built-in cassette interface and your home cassette recorder. Other sources of programs are the Apple software library and the Apple II owner down the block.

Increased memory can extend your horizons. For instance, with 12K or more memory, Apple II can generate a high-resolution (280h x 192v) graphic display useful for scientific, medical or artistic applications. The user memory can be expanded up to 48K bytes by simply inserting more memory chips in the sockets provided.

Also, there are several peripheral boards scheduled for introduction soon which will plug into the expansion connectors—Apple II has eight built-in—enabling you to synthesize music or talk to another computer over the phone. Many more interesting peripheral boards to expand your Apple II will be available this year.

As you become an expert, you'll grow to appreciate the sophistication inside Apple II. Its 2K byte ROM monitor contains a mini-assembler, a disassembler, single-step and trace routines, floating point package, a software simulated 16-bit processor routing, and more.



Apple II is a complete, self-contained, ready to use computer. Standard features include BASIC and Monitor in ROM (8K bytes), Color Graphics, up to 48K bytes RAM (4K included), cassette interface, Apple GAME I/O connector, typewriter-style ASCII keyboard, high-efficiency switching power supply and plastic molded case. Also included as standard are: 1 demonstration cassette tape, two game paddle controllers and detailed operations manual.

MICROPROCESSOR:

6502 operating at 1 MHz clock.

VIDEO DISPLAY

The Apple II video display section displays memory as either text, *color graphics*, or *high-resolution graphics* (completely transparent memory access). Both graphics modes can be selected to include 4 lines of text at the bottom of the display area. *All display modes are software selectable*. In addition, the user can select under software one of two memory blocks to be displayed.

Text

- 40 characters/line, 24 lines.
- 5 x 7 upper case characters.
- Normal, inverse or flashing characters.
- Extensive display control software in ROM.
- Full cursor control.
- Fast display — 1000 cps.

Color Graphics

- 40h x 48v resolution or 40h x 40v with 4 lines text.
- 15 colors — color generated digitally.
- BASIC commands to use graphics easily: COLOR=, PLOT x, y, HLIN, VLIN SCRN.

High Resolution Graphics

- 280h x 192v resolution or 280h x 160v with 4 lines text.
- 4 colors — black, white, violet, green.
- Displays 8K bytes (requires 12K minimum RAM).

MEMORY

RAM is organized into 3 increments. Each increment can be either 4K bytes using 4K chips or 16K bytes using advanced 16K chips. Memory may be easily increased by inserting an additional increment of chips. From 4K to 48K bytes of RAM can be contained on the single board. 8K bytes of ROM are supplied which permanently store Apple BASIC (6K) and a powerful system monitor (2K). Two additional ROM sockets are provided for future Apple software.

- Up to 48K bytes on-board RAM — no peripheral memory boards!
- Unique automatic RAM refresh system, completely transparent.
- Uses 4096, 2104 type 4K and 4116, 2116 type 16K RAMs.
- Fast memory — 350ns access time.

I/O

Apple II includes as standard an ASCII keyboard, audio cassette interface, 8 peripheral board connectors, speaker, Apple GAME I/O connector and two game paddle controllers.

- Reliable typewriter-style keyboard.
- Fast cassette interface — 1500 bps.
- Peripheral board connectors:
 - fully buffered busses & timing
 - Daisy-chained interrupt and DMA priority structure
- GAME I/O — 4 paddle inputs, 3 TTL inputs and 4 TTL outputs.

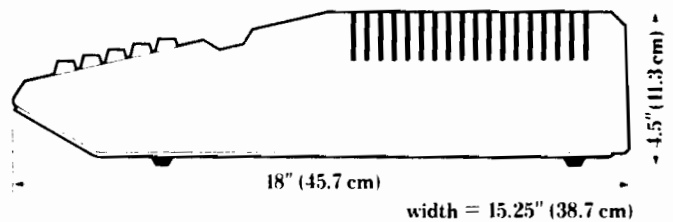

BASIC

Apple BASIC is an integer BASIC supplied in 6K bytes of ROM and includes the following features (in addition to normal basic features):

- Apple BASIC is a fast translated BASIC.
- Any length variable names (ALPHA, BETA\$).
- Syntax and range errors indicated immediately when entered.
- Multiple statements on one line.
- Integers from -32767 to 32767.
- String arrays to 255 characters. Single dimension integer arrays.
- Graphics Commands: COLOR= expr, PLOT, HLIN (draw horizontal line), VLIN, SCRN (x, y) (reads the screen color).
- Paddle read function: PDL (0-3).
- TEXT and Graphics Commands set display mode from BASIC.
- Immediate execution of most statements.
- Memory boundary adjust (does not destroy current program).
- Break and Continue program execution.
- Debug commands: line number trace and variable trace.
- Switchable I/O device assignments.
- Direct memory access: PEEK, POKE, CALL commands.
- Cassette SAVE and LOAD commands.
- Auto line number mode.
- RND, SGN, ASC, LEN and ABS functions.
- POP instruction pops the return stack one level.
- GOTO expr, GOSUB expr allowed.

MONITOR

- 2K byte ROM monitor.
- Screen control (intelligent display routines). Full cursor control.
- Scrolling window adjustable (protected screen feature).
- Software simulated single-step and trace modes.
- Software simulated 16-bit processor.
- Dis-assembler and mini-assembler
- Input/Output device assignment.
- Editing on keyboard entry.
- Floating point package.
- Breakpoint handling.
- Register examine/modify.
- Read/Write cassette routines.
- Inverse/Normal video selection.
- Hex add/subtract for relative branch calculations.

Apple II™

Apple II is a completely assembled and tested computer system. It includes 8K bytes of ROM, rugged plastic molded case, typewriter-style keyboard, high efficiency switching power supply, two game paddles, vinyl carrying case, all cords and cables, and a complete operator's manual.

Catalog Order No.	Description	Price
A2S004X	Apple II Complete Computer — 4K Bytes RAM	\$1298.00
A2S008X	Apple II Complete Computer — 8K Bytes RAM	1398.00
A2S012X	Apple II Complete Computer — 12K Bytes RAM	1498.00
A2S016X	Apple II Complete Computer — 16K Bytes RAM	1678.00
A2S020X	Apple II Complete Computer — 20K Bytes RAM	1778.00
A2S024X	Apple II Complete Computer — 24K Bytes RAM	1878.00
A2S032X	Apple II Complete Computer — 32K Bytes RAM	2158.00
A2S036X	Apple II Complete Computer — 36K Bytes RAM	2258.00
A2S048X	Apple II Complete Computer — 48K Bytes RAM	2638.00

Peripherals, Boards and Modules

A2B004X	Single Board Computer — 4K Bytes RAM	\$ 598.00
A2B008X	Single Board Computer — 8K Bytes RAM	698.00
A2B012X	Single Board Computer — 12K Bytes RAM	798.00
A2B016X	Single Board Computer — 16K Bytes RAM	978.00
A2B020X	Single Board Computer — 20K Bytes RAM	1078.00
A2B024X	Single Board Computer — 24K Bytes RAM	1178.00
A2B032X	Single Board Computer — 32K Bytes RAM	1458.00
A2B036X	Single Board Computer — 36K Bytes RAM	1558.00
A2B048X	Single Board Computer — 48K Bytes RAM	1938.00
A2M001X	Switching Power Supply	279.50
A2M002X	Keyboard Assembly	149.50
A2M003X	Case Assembly	163.00

Memory

A2C004X	Add-In Memory — 4K Bytes (4K RAMs)	\$ 125.00
A2C016X	Add-In Memory — 16K Bytes (16K RAMs)	600.00
	Memory Configuration Blocks (Set of 3)	
A2C020X	4K, 4K, 4K BASIC	10.00
A2C021X	4K, 4K, 4K High Resolution	10.00
A2C022X	16K, 4K, 4K	10.00
A2C023X	16K, 16K, 4K	10.00
A2C024X	16K, 16K, 16K	10.00

Accessories

A2C003X	A.C. Power Cord	\$ 5.00
A2C005X	Cassette Interface Cables	4.50
A2M009X	Vinyl Carrying Case	50.00
A2M007X	Game Paddles — Two Players	30.40

Literature and Tapes

A2L001X	Apple II Operator's Manual	\$ 10.00
A2T001X	High Resolution Graphics Cassette	5.00
A2T002X	Breakthrough Game Cassette	5.00

IMSAI 8080

MICROCOMPUTER SYSTEM

IMSAI 8080

Here's a high-quality microprocessor-based system that gives you the performance and flexibility you demand at a price you can afford. Whether you're a cost/performance-conscious OEM, or an uncompromising experimenter, IMSAI 8080 should be your affordable choice.

The computer, using Intel's 8080A chip, makes up to 64K words (bytes) of memory directly accessible. With a basic machine cycle of 0.5 microsecond, and with as many as 256 I/O ports directly accessible, this is definitely a high-capability machine.

The computer is backed by a family of options and peripheral devices and interfaces to do just about any job... serial and line printers, a video terminal, tape cassette, disk or teletypewriter.

It's modular, so you can easily add to your IMSAI 8080 system.

While the computer is designed as a high-quality commercial computer, there's no compromise in quality or value if you purchase it as a kit. You can get it together and bring it up in 10 to 20 hours, depending on your experience. Plug-in modularity minimizes solder connections to speed assembly and enhance reliability.

Your IMSAI 8080 computer will be supported by complete documentation including:

- IMSAI 8080 System User's Manual
- Intel 8080 Microprocessor System User's Manual, describing the Intel devices and instruction set
- An Introduction to Microcomputers, textbook on the programming and architecture of microcomputer systems

Your computer is backed by a 90-day warranty, and full factory service at moderate cost.

HARDWARE FEATURES

FRONT PANEL

- Handsome and functional, with sharp, readable legends behind acrylic panel
- All indicators long-life LED's... panel filter enhances contrast
- Eight extra LED's programmed as an output port
- Easy-to-use paddle handle switches
- Easily customized for private labeling

MECHANICAL

- Sturdy card-cage construction... holds up to 22 cards
- Straight-through backplane design... no special-purpose slots
- Short backplane sections available
- Flat cable interconnections throughout
- Absolute minimum of point-to-point wiring... no point-to-point wiring to front panel permits easy panel removal
- Rack-mount cabinet available
- Pc boards double-sided with plated-through holes and solder mask
- Pc boards of glass-fiber reinforced epoxy laminate
- Pc board contact fingers gold-plated over nickel

ELECTRICAL

- Front panel circuits make one-shot timing links non-critical
- Latest LSI and MSI components... minimizes package count
- Heavy-current tri-state bus drivers

POWER SUPPLY

- Heavy-duty supply... 28 amperes for system expansion
- Power regulated on-board by IC devices with thermal current limits
- Generous ceramic disk power decoupling capacitors... dipped tantalum capacitors for board decoupling

SYSTEM

- Designed from the beginning for multi-processor, shared memory capability
- Software drivers available for all IMSAI 8080 peripherals

SPECIFICATIONS

PROCESSOR

INTEL 8080A

MICROPROCESSOR CHIP.

Memory (directly addressable): 65,536 words

Word Size: One byte (8 bits)

Register Instruction Cycle Time:

2 microseconds

Basic Machine Cycle Time:

0.5 microsecond

Number of Input/Output Ports: 256

Machine Instruction Set: 78 basic

instructions, 174 including variants
Nested Subroutine Calls: Number limited only by memory size

Interrupts: Eight hardware levels (with optional PIC-8 board)

Registers: Six plus stack pointer, program counter, accumulator and status register

Memory Type: Semiconductor (1K x 1 bit chips)

CABINET

Custom aluminum case with acrylic front panel

Dimensions: 19½ in. wide, 17 in. deep, 7 in. high (rack mount option available)

Front Panel Switches: Paddle handle

POWER

Requirements: 120V, 50-60 Hz, single phase, less than 50 Watts (basic system)

Maximum Power Capability: Up to 500 Watts in a large system

INTERCONNECTIONS

Back panel accommodates ten EIA-type 25-pin connectors. Opening and cable clamp furnished for flat cables to exit from cabinet. Flat cables used throughout.

THE BASIC IMSAI 8080 MICROCOMPUTER SYSTEMS

I-8080 WITH 22 SLOT MOTHER BOARD

Catalog Order No. PCS-80/10K	\$699.00
IMSAI I-8080 Computer Kit	\$752.00
Catalog Order No. PC-80/10A	
IMSAI I-8080 Computer Assembled	
W/10 EXPM	\$950.00

The standard microcomputer includes:

- Front panel and control board (CP-A)
- Chassis with 22-slot card cage
- Sturdy, attractive dust cover (DC)
- Microprocessor board (MPU-A)
- 28-ampere power supply (PS-28)
- Mother Board with six board slots
- Two 100-pin edge connectors with card edge guides (EXPM)
- IMSAI 8080 System User's Manual
- Intel 8080 Microprocessor System User's Manual
- An Introduction to Microcomputers
- Software including monitor, assembler, editor, loader and debugger (punched paper tape and source listings)

MOTHER BOARD

Card-to-card spacing on the Mother Board is 3/4-inch, except for the first position reserved for the front panel board or any other board in dedicated applications.

The twenty-two slot Mother Board offers maximum expansion capability.

Heavy power traces handle the large currents that exist in a heavily loaded backplane. High-quality connectors have gold-plated contacts for reliability and long life.

FRONT PANEL

The CP-A Board forms the operator's panel. It includes switches, indicators and logic needed for manual operation. The panel is completely self-contained and plugs directly into the first Mother Board slot. Or it may be connected through an extender board to any available slot in the Mother Board. When the first slot is not used for the front panel, that slot may be used by another board, such as the Parallel I/O Board with its LED indicators visible.

Front panel facilities include:

- 16 address/data switches
- 16 LED address indicators
- 8 LED data bus indicators
- 8 LED programmed output bit indicators
- 6 control function switches
- 8 LED status indicators (including control indicators for INTERRUPT ENABLED, RUN, WAIT and HOLD)

The front panel includes logic that drives the programmed output indicators, and reads the input byte from the high-order address switches. DATA BUS

indicators show data either read or written by the processor.

Indicators are wide-angle LED's behind a contrast-enhancing acrylic panel assembly. Photographically produced panel markings are crisp and explicit and can never wear off. Bit positions are numbered and labeled for both hexadecimal and octal notation. Special labels may be easily inserted to identify special functions for the programmed output LED's.

Switches are high-quality units, with paddle handles color-coded for easy, error-free operation.

POWER SUPPLY

The Power Supply (PS-28) is designed for use with pc boards having on-board regulators. Outputs are +10V and $\pm 18V$ at no load, and approximately +7V and $\pm 15.8V$ at full load.

A Power Supply pc board contains rectifiers and 120V ac switching and fusing functions. The board provides terminals for switched ac power, both fused and unfused, for a ventilating fan and auxiliary power outlets on the back panel. When the computer is supplied without the front panel, an ac power switch is mounted on the Power Supply Board.

A custom-built transformer and large, conservatively rated filter capacitors are mounted on the chassis.

PROCESSOR BOARD

The Processor Board (MPU-A) contains the Intel 8080A Microprocessor chip, clock crystal oscillator and clock drivers, status signal latches and bidirectional bus drivers, as well as on-board power supply voltage regulators.

The bus arrangement and board connector are designed so that the MPU-A board may be used directly in the MITS Altair M8800 Microcomputer system.

The 2-MHz, 2-phase non-overlapping clock for the processor chip is provided by an 18-MHz crystal and 8224 clock driver. An 8212 chip latches status signals. Two 8216 tri-state, bidirectional bus drivers interface the processor chip with the IMSAI 8080 data buses. Other tri-state bus drivers drive address, status and control lines.

The MPU-A board receives $\pm 16V$ and +8V supply voltages and uses on-board regulators to obtain required voltage levels.

The board edge connector has 100 pins on 0.125-inch centers, with 50 pins on each side. Except for gold-plated contact fingers, circuit traces are tin-lead plated for easier, more reliable solder connections.

The board includes a power-on reset circuit, plus pull-up resistors so that without the front panel, power-on reset will start the program at location zero.

I-8080-OEM WITH 22 SLOT MOTHER BOARD

Catalog Order No. PCS-80/11K	
IMSAI I-8080 OEM Computer Kit	\$629.00
Catalog Order No. PCS-80/11A	
IMSAI I-8080 OEM Computer Assembled	
With 10 EXPM	\$749.00

Basic I-8080 system computer less front panel Power on/off switch is provided.

I-8085 WITH 22 SLOT MOTHER BOARD

Catalog Order No. PCS-80/14K	
IMSAI I-8085 Computer Kit	\$ N/A
Catalog Order No. PCS-80/14A	
IMSAI I-8085 Computer Assembled	
With 10 EXPM	\$ N/A

8085-based mainframe Central Processor MPU-B 28 amp power supply. 22-slot mother board. Programmer front panel.

I-8085 OEM WITH 22 SLOT MOTHER BOARD

Catalog Order No. PCS-80/15K	
IMSAI I-8085 OEM Computer Kit	\$ N/A
Catalog Order No. PCS-80/15A	
IMSAI I-8085 OEM Computer Assembled	\$ N/A

Same as I-8085 except programmer front panel is replaced by operator's front panel (contains only key-lock, reset and interrupt switches).

PROCESSOR BOARD

MPU-B. 8085 based CPU. 8080 software and S-100 compatible. 50% faster. Interrupts, serial and parallel I/O. ROM monitor firmware. 256 byte RAM memory. Requires only power supply and terminal to run.

OPTIONS AND COMPONENTS FOR THE BASIC SYSTEM

RACK MOLINT RM

Catalog Order No. RM
Rack mount option. For standard 19" Retma cabinet. When ordered, supplied in lieu of single-height table top dust cover. Kit or Assembled

\$ 20.00
This hardware lets you mount the computer chassis in a standard 19-inch electronics rack. It consists of side panels that bolt to the inner sides of the cabinet and support the chassis. A special dust cover is provided in place of the standard dust cover, as well as a modified front panel sheet metal escutcheon. This option must be ordered in conjunction with the basic computer system.

22-SLOT MOTHER BOARD EXP-22

Catalog Order No. EXP-22	
22 Slot Mother Board	\$ 65.00

Twenty-two-slot Mother Board replaces all other Mother Board sections in the computer, offering maximum expansion capability. Reduced price available if ordered with basic system. Edge connectors must be ordered separately.

EDGE CONNECTOR EXPM

Catalog Order No. EXPM	
Edge Connector with Guides	\$ 5.50

Connects a pc board in the computer to the Mother Board. Consists of a 100-pin edge connector to be soldered to Mother Board, plus two card-edge guides that attach to side of the card cage. Extra edge connectors may be ordered with the basic system to permit easy future expansion.

COOLING FAN FM

Catalog Order No. FM
Cooling Fan \$ 20.00

Muffin-type fan that may be installed at rear of computer chassis. It is recommended when there are 10 or more boards in the chassis.

POWER SUPPLY PS-28

Catalog Order No. PS-28
Power Supply Kit \$100.00

The standard IMSAI 8080 power supply providing 28 amperes at +7V dc minimum, and 3 amperes each at +15.8V and -15.8V minimum. Operates from 120V, 50-60 Hz power.

FRONT PANEL CP-A

Catalog Order No. CP-A/K
Front Panel Kit \$189.00
Catalog Order No. CP-A/A
Front Panel Assembled \$325.00

The standard front panel and control card. Requires edge connector EXPM.

MICROPROCESSOR BOARD MPU-A

Catalog Order No. MPU-A/K
Microprocessor Board Kit \$190.00
Catalog Order No. MPU-A/A
Microprocessor Board Assembled \$350.00

This is the Microprocessor Board that is part of the basic computer. Requires edge connector EXPM.

MICROPROCESSOR BOARD MPU-B

Catalog Order No. MPU-B/K
Microprocessor Board Kit \$ N/A
Catalog Order No. MPU-B/A
Microprocessor Board Assembled \$ N/A

8085 Microprocessor board with 256 bytes RAM, 1K ROM, parallel and serial I/O ports.

DOUBLE HIGH MOUNTING OPTION DNMO

Catalog order No. DHMO
Double High Cabinet \$ 50.00

Double high mounting option. Will mount PCS-80 cabinets in a two high configuration. When ordered, a single cover is supplied in lieu of the two single-height dust covers. Includes tilt bracket for convenient positioning of IKB-1.

PRIORITY INTERRUPT/INTERVAL CLOCK BOARD PIC-8

Catalog Order No. PIC-8K
Priority Interrupt Kit \$125.00
Catalog Order No. PIC-8A
Priority Interrupt Assembled \$238.00

The PIC-8 board lets your processor perform jobs between interrupts, without the need to continually poll devices to see if any require service.

Priority interrupt logic on this board monitors the eight priority interrupt lines on the computer Mother Board. It can service either single or multiple interrupt requests. When enabled and it receives an interrupt request, the PIC-8 determines if the request priority is higher than the software-controlled present priority and, if it is, issues a restart instruction that directs the system to the appropriate one of eight priority-controlled restart locations.

For multiple interrupt requests, the PIC-8 determines the highest-priority request and processes it normally.

Note that the system does not store inactive requests, and that a peripheral device must hold its interrupt request until it is acknowledged by the microprocessor.

The present-priority status register may be set by software to any desired value to prevent generation of low-priority interrupts until the register is reset to a lower value. The status register may be set to permit all levels of interrupt to occur.

The PIC-8 board also includes a clock circuit which generates program-controlled interrupts at intervals preset from 0.1 millisecond to 1 second. Any three rates may be jumper-selected, selecting from rates of 0.1, 0.2, 1.0, 2.0, 10, 20, 100, 200 or 1000 milliseconds. Any one of the three selected rates, or none, may be selected by the program.

One bit of the DATA OUTPUT port is connected to a transistor and jumper pads to provide a special-purpose program-controlled output. The circuit board also provides five 16-pin DIP hole patterns with power and ground decoupling for special circuits of your own design. Hole patterns are drilled for wire-wrap sockets. There is room on the board to mount a small speaker driven by the aforementioned transistor or other circuits of your own design.

An edge connector EXPM is required to install the PIC-8 board.

GENERAL PURPOSE PROTOTYPE BOARD GP-88

Catalog Order No. GP-88K
Proto Board Kit \$ 39.00
Catalog Order No. GP-88A
Proto Board Assembled \$ 47.00

This board may be used to develop and build your own custom circuits. It offers space for up to 31 16-pin DIP devices and two 40-pin DIP's. Or three 24-pin DIP's may be installed in the two 40-pin spaces. Hole patterns are drilled for wire-wrap sockets.

The board is supplied with an on-board regulator and tantalum decoupling capacitor. An edge connector EXPM is required to install the board.

EXTENDER BOARD EXT

Catalog Order No. EXTK
Extender Board Kit \$ 39.00
Catalog Order No. EXTA
Extender Board Assembled \$ 49.00

The Extender Board plugs into an edge connector on the Mother Board and is used to extend a functional circuit board out of the card cage for access to circuits. End pins are marked at every fifth pin for fast identification.

Using the Extender Board, the front panel/control board may be attached to any slot in the chassis. Requires edge connector EXPM.

INPUT/OUTPUT INTERFACE BOARDS

SERIAL I/O INTERFACE SIO 2-2

Catalog Order No. SIO 2-2K
Serial I/O Kit \$156.00
Catalog Order No. SIO 2-2A
Serial I/O Assembled \$299.00

The SIO 2-2 Serial I/O Interface board contains two identical ports, each permitting the computer to communicate with most peripheral devices through an RS232 or current loop interface. The two ports are independent. Each may operate through either the current loop or RS232 mode, and will operate in full-duplex or half-duplex with all control signals.

You can run synchronous or asynchronous lines, full- or half-duplex, at any baud rate up to 9600 baud (asynchronous) or 56,000 baud (synchronous). Baud rates up to 9600 (asynchronous) or 38,400 (synchronous) are selected by jumpers on the board. Asynchronous baud rates are 75, 110, 150, 300, 600, 1200, 2400, 4800 and 9600. Synchronous rates are 1200, 2400, 4800, 9600, 19,200 and 38,400. Other rates are made possible using the SIOC board which mounts directly on the SIO board.

Control lines for each input include DSR, DTR, RTS, CTS and Carrier Detect. RS232 receivers and drivers are also provided for clocks in synchronous operations. Jumpers permit using the board as either the receiving (terminal) end of a communication line or the originating (computer) end.

Each interface is structured around an Intel 8251 USART chip. This chip allows extensive program control of I/O functions including control line and sync character selection, and error-condition sensing and recovery. The board generates interrupts for received characters, transmitter buffer empty, transmitter empty or sync character. A jumper selects the priority interrupt (acknowledged by the computer only if it includes the PIC-8 Priority Interrupt board). All functions may be program-controlled so that you can use the full capability of the board without using interrupts.

The board may be jumper-adapted to respond either to I/O instructions from the IMSAI 8080 system or to memory reference instructions for memory-mapped I/O.

If you need to change the data format or protocol in an RS232 line, you can easily connect an IMSAI 8080 in the line to intercept, process and retransmit the data. That's because jumper facilities let you use both of the serial I/O ports, with control lines connected together.

Connector fingers on the upper edge of the board accommodate two flat cables (CABLE A) to connect directly to 25-pin EIA-type connectors, one for each port. No hand wiring is required to receive or originate an RS232 line.

An edge connector EXPM is needed to install the SIO 2-2 board. One or two cables (CABLE A) are optional.

SERIAL I/O INTERFACE BOARD SIO 2-1

Catalog Order No. SIO 2-1K	
Serial I/O Kit	\$125.00
Catalog Order No. SIO 2-1A	
Serial I/O Assembled	\$235.00

This is, essentially, an SIO 2-2 board containing chips for a single port. You can add another port later with the SIOM module.

SERIAL I/O MODULE SIOM

Catalog Order No. SIOMK	
Serial Module Kit	\$ 47.00
Catalog Order No. SIOMA	
Serial Module Assembled	\$ 69.00

This set of components adds the second I/O port to an SIO 2-1 board.

SERIAL I/O CLOCK BOARD SIOC

Catalog Order No. SIOCK	
Clock Board Kit	\$ 31.00
Catalog Order No. SIOCA	
Clock Board Assembled	\$ 59.00

This piggyback board attaches to a SIO board to provide any non-standard baud rate from 1 baud to 56K baud. The SIOC board is needed for *each port* using a non-standard baud rate.

PARALLEL I/O INTERFACE PIO 4-4

Catalog Order No. PIO 4-4K	
Parallel I/O Board Kit	\$156.00
Catalog Order No. PIO 4-4A	
Parallel I/O Board Assembled	\$299.00

Use the Parallel I/O board as a custom TTL-level interface to peripheral devices

The board provides four 8-bit input ports, and four 8-bit output ports. Each input and output port has its own latch and hand-shaking logic for conventional parallel transfer.

Hand-shaking logic on any I/O port will generate an interrupt, with the priority level of the interrupt selected on the board. (Note that the processor will not respond to the interrupt unless the computer contains the PIC-8 Priority Interrupt board.)

The ports are addressed by four sequential addresses jumper-selected to be in the 256 I/O address space. You may also address the board with memory-mapped I/O, using normal memory read or write instructions to transfer data through the I/O ports.

The Parallel I/O board includes a set of eight LED's for each output port (32 total). You'll find this useful for debugging, monitoring system activity, or replacing the front panel in dedicated applications. Mount a photographic mask, with appropriate legends, over the LED's to form a readable display. The front panel can still be used during development by plugging it into another slot.

The board includes an IC regulator for the +5V supply, with tantalum capacitor filters on either side of the regulator. There is ample ceramic disk capacitor bypassing throughout the board.

You can take +5V power (up to 300 mA total) from the +5V and ground pins on the I/O port connectors of a fully utilized board. For each unused port, an additional 100 mA may be drawn from the board. If, for example, you are using four output ports and only two input ports, 500 mA is available from the board.

On the top of the board, fingers accommodate two 50-pin connectors (25 pins per side on 0.1-inch centers), one for input ports, and one for output ports.

An edge connector EXPM is needed to install the Parallel I/O board. PIO cables for input and output are optional.

PARALLEL I/O BOARD PIO 4-1

Catalog Order No. PIO 4-1K	
I/O Board Kit	\$ 93.00
Catalog Order No. PIO 4-1A	
I/O Board Assembled	\$140.00

This is a PIO 4-4 board containing components for one 8-bit input and one 8-bit output port. Expand it later with 1, 2 or 3 sets of components by adding PIOM sets. Requires edge connector EXPM. PIO cables for input and output are optional.

PARALLEL I/O MODULE PIOM

Catalog Order No. PIOMK	
Parallel Module Kit	\$ 22.00
Catalog Order No. PIOMA	
Parallel Module Assembled	\$ 39.00

This is a set of components to add a single port to a PIO 4-1 board.

PARALLEL I/O BOARD PIO 6-6

Catalog Order No. PIO 6-6K	
Parallel Board Kit	\$169.00
Catalog Order No. PIO 6-6A	
Parallel Board Assembled	\$239.00

Six port parallel interface board. 8-bit ports software selectable for input or output. Cables optional.

PARALLEL I/O BOARD PIO 3-3

Catalog Order No. PIO 3-3K	
Parallel Board Kit	\$139.00
Catalog Order No. PIO 3-3A	
Parallel Board Assembled	\$239.00

Three port parallel interface board. 8-bit ports software selectable for input or output. Cables optional.

PARALLEL I/O EXPANSION PIO 6M

Catalog Order No. PIO 6MK	
Parallel Module Kit	\$ 54.00
Catalog Order No. PIO 6MA	
Parallel Module Assembled	\$ 90.00

Three port parallel I/O expansion module provides expansion of PIO 6-3 to six ports.

MULTIPLE I/O BOARD MIO

Catalog Order No. MIOK	
I/O Board Kit	\$195.00
Catalog Order No. MIOA	
I/O Board Assembled	\$350.00

Multiple I/O board (two parallel, ports, one serial port, one control port and TARBELL tape cassette interface) (order one to three CABLE A's and one or two CABLE M's).

VIDEO INTERFACE BOARDS

VIDEO BOARD VIO-C

Catalog Order No. VIO-CK	
Video Board Kit	\$325.00

Catalog Order No. VIO-CA	
Video Board Assembled	\$465.00

The VIO produces a 24 x 80 screen format in which, under program control, either or both dimensions may be cut in half with proportionate increase in character size. Another feature of the VIO is programmable character fonts (256 combinations possible). A onboard ROM supplied with the VIO provides data entry and text editing features including protected format and character/line insert and delete. 2K refresh memory and ROM firmware.

VIDEO BOARD VIO-B

Catalog Order No. VIO-BK	
Video Board Kit	\$275.00
Catalog Order No. VIO-BA	
Video Board Assembled	\$405.00

Same as VIO-C with upper case only.

VIDEO BOARD VIO-A

Catalog Order No. VID-AK	
Catalog order No. VIO-AK	
Video Board Kit	\$275.00
Catalog Order No. VIO-AA	
Video Board Assembled	\$405.00

Same as VIO-C without ROM firmware.

VIDEO BOARD BASIC VIO

Catalog order No. BVIOK	
Video Board Kit	\$190.00
Catalog Order No. BVIOA	
Video Board Assembled	\$335.00

1K screen refresh, upper case only, all standard screen formats except 80 x 24

VIDEO MODULE VIO-AC

Catalog Order No. VIO-ACK	
Video Module Kit	\$ 60.00

Converts VIO-A to VIO-C

VIDEO MODULE VIO-BC

Catalog Order No. VIO-BCK	
Video Module Kit	\$ 60.00

Converts VIO-B to VIO-C

VIDEO MODULE VIO-CC

Catalog Order No. VIO-CCK	
Video Module Kit	\$150.00

Converts VIO Basic to VIO-C

MEMORIES

4K RANDOM ACCESS MEMORY RAM 4A-4

Catalog Order No. RAM 4A-4K	
4K RAM Kit	\$139.00
Catalog Order No. RAM 4A-4A	
4K RAM Assembled	\$279.00

The basic memory is the 4K Random Access Memory (RAM 4A-4). This board stores 4096 bytes of changeable information, either programs or data. Information may come from a computer program, a peripheral device, or the front panel switches.

RAM 4A-4 offers a number of unique features to make program development easier. A powerful memory write-protect feature lets you protect 1K-byte blocks of data under program or front panel control. The program can test for the protect status of any 1K-byte block, and an interrupt is generated when a protected block is illegally accessed.

The board has two LED indicators for each 1K-byte block. One is lit when the block is write-protected, and the other is lit when the block is being accessed for reading or writing.

Storage is static using 2102-type chips (no refresh cycle) with a cycle time of 500 nanoseconds. The board

address can be jumper-selected to any 4K block of the computer's 64K-byte address space. The memory is fast enough so that no wait cycles are required. If you use slower memory chips a wait cycle can be generated.

Tri-state bus drivers and three fully decoupled on-card voltage regulators are used.

The board also includes a battery backup circuit (battery not included) to save memory contents when ac power is turned off. Each RAM 4A-4 board requires one edge connector (EXPM).

16K RANDOM ACCESS MEMORY RAM 16

Catalog Order No. RAM 16K	
16K RAM Kit	\$449.00
Catalog Order No. RAM 16A	
16K RAM Assembled	\$679.00

16K byte dynamic random access memory. Paging option allows virtual memory addressing in 16K byte increments. S-100 compatible. Hidden refresh and no wait states.

32K RANDOM ACCESS MEMORY RAM 32

Catalog Order No. RAM 32K	
32K RAM Kit	\$749.00
Catalog Order No. RAM 32A	
32K RAM Assembled	\$1099.00

32K byte dynamic random access memory. Paging option allows virtual memory addressing in 16K byte increments. S-100 compatible. Hidden refresh and no wait states.

64K RANDOM ACCESS MEMORY RAM 64

Catalog Order No. RAM 64K	
64K RAM Kit	\$2599.00
Catalog Order No. RAM 64A	
64K RAM Assembled	\$3899.00

64K byte dynamic random access memory. Paging option allows virtual memory addressing in 16K byte increments. S-100 compatible. Hidden refresh and no wait states.

This board (PROM 4-4) provides non-volatile program storage that cannot be changed by the computer or erased when power is turned off. Use a PROM board for programs that are run frequently. For example, IMSAI provides the BASIC language in PROM.

The board contains 16 Intel 1702A, or equivalent, EPROM chips in sockets. They may be erased by ultraviolet light and can be reprogrammed electrically by a PROM programmer unit. Each device stores 256 bytes for a total of 4K bytes on the board. Each of the 16 PROM sockets is individually addressable and PROM's operate independent of each other. Thus, memory space may be structured by simply arranging PROM's in appropriate sockets. The board address is jumper-selected to any 4K block of the computer's 64K memory space.

A user-selectable memory-read delay (0 to 3 machine cycles) allows most efficient use of fast or slow PROM chips. The chips supplied have an access time of 1000 nanoseconds.

The board includes tri-state bus drivers and fully decoupled supply voltage regulators. An EXPM edge connector is required to install the board.

512 BYTES PROM MEMORY PROM 4-512

Catalog Order No. PROM 4-512K	
PROM Board Kit	\$165.00
Catalog Order No. PROM 4-512A	
PROM Board Kit	\$247.00

This is a memory board (PROM 4-512) with only two PROM chips that provide 512 bytes of PROM storage. The board may be fully populated, in 512-byte increments, up to 4K bytes by adding 512 Byte Memory Module (MM702-5) sets. An EXPM edge connector is required.

READ ONLY MEMORY PROM 4-4

Catalog Order No. PROM 4-4K	
PROM Board Kit	\$399.00
Catalog Order No. PROM 4-4A	
PROM Board Assembled	\$579.00

Catalog Order No. MM702-5K	
PROM Module Kit	\$ 50.00
Catalog Order No. MM702-5A	
PROM Module Assembled	\$ 69.00

This is a set of PROM chips (MM702-5) to add 512 bytes of storage to a PROM 4-512 board.

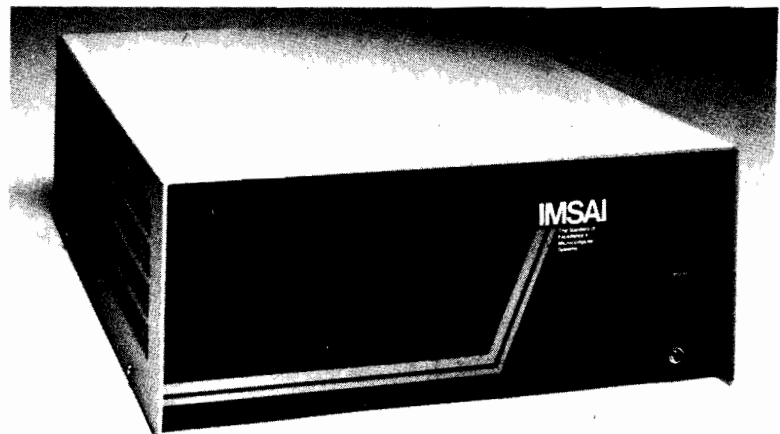

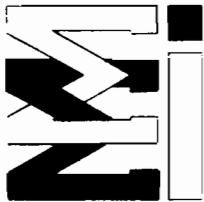
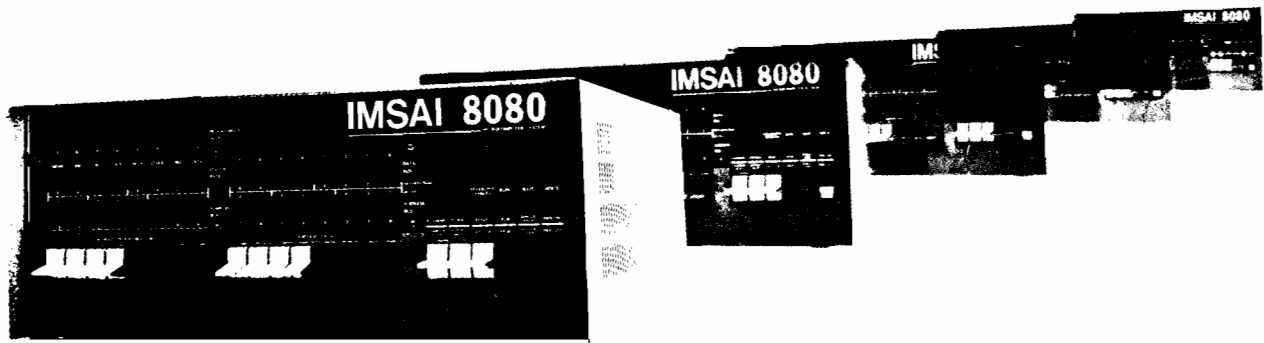

System & Software, Inc.

The Virtual Micro™

The era of the Virtual Machine has finally arrived. Today, with the Virtual Micro™ software, you may turn your 8080 or Z-80 into a powerful multi-user, multi-programming system which provides you the ultimate performance for your application horizon!

As the state of the art in microprocessor programming, Virtual Micro™ allows more than one user to access the same microcomputer resources simultaneously as if each user had his own machine. That is why it is called the Virtual Micro™.

Under Virtual Micro™ each user senses a system responsiveness found only in large systems with the operator ease of a typewriter. The software incorporates rapid time slices to dynamically allocate CPU resources to CPU bound jobs. As a result, a multi-tasking and multi-user system with maximum responsiveness and utilization is achieved. In addition, the software provides interactive BASIC programming, and a floppy disc file manager with individual and system directory. Features found in the Virtual Micro™ include:

- Multi-user/multi-tasking BASIC supporting up to eight users.
- Dynamic allocation of system resources.
- Floppy disc file management system.
- Instant bootstrapping.
- Line printer spooler.
- Realistic 4K expandable memory partition per user.
- Supports for a multitude of I/O devices and speeds.
- Hardware compatibility with all standard 8080 (S-100) systems.

Dynamic allocation of CPU resources

Under the control of the Virtual Micro™ software, multiple tasks are allocated with 1/60th of a second time slices. At the end of each time slice, the individual task is suspended and current states of the task are stored for future execution. The program is continued at the next time slice for this task.

The Virtual Micro™ has a resource allocation system that effectively maximizes CPU utilization. That is when a current task cannot proceed processing pending a I/O completion, this task is suspended. The CPU is then assigned to the next task waiting in queue.

Operator response

The Virtual Micro™ software provides high speed keyboard response due to the 1/60th of a second sampling rate. The fastest "touch" typists will never exceed the input capacity of the system. In addition, the fixed sampling rate enables CPU bound task to get full shares of the total processing time. Couple this with the dynamic resource allocation aspects of the Virtual Micro™, this enables the system to appear totally dedicated to the individual user.

Instant bootstrap

The Virtual Micro™ operating system resides on the disc for fast, convenient bootstrapping with a minimum of operator steps. Just power up, reset, and run.

Line printer spooling

The Virtual Micro™ has a spooling feature that allows users to output to a single, high speed printer. Listings and formatted results are queued as received for successive printing. This is made possible by the resource sharing nature of the Virtual Micro™ system. Thus, the line printer as well as the disc are considered as system resources that are shareable by user's task under Virtual Micro™.

Floppy disc file management system

The Virtual Micro™ provides two levels of files—system and user. User may create, save, load and erase their own files. They may also access system files for their use. All the system files are protected from unauthorized penetration, however.

File directories for both the individual and system files are available. Individuals are restricted to their own files and system files to assure the integrity of the system.

Hardware compatibility

The Virtual Micro™ software will operate on practically any 8080 or Z-80 CPU mainframe—IMSAI®, Altair™, Vector Graphics, Vector-1; Cromemco, Z-2; and Polymorphic Systems, Poly 88. I/O devices may be interfaced to the system including high speed CRT's, ASCII teletypewriters, paper tape reader and punch, high speed printers, etc. Additional devices such as graphic terminals, Video Display Module (VDM), Diablo Terminal, etc., may easily be added.

Extended disc BASIC

Virtual Micro™ supports a disc based BASIC interpreter to allow interactive BASIC programming. Both string and floating point data types, as well as a full set of functions for manipulating data, found only in most of the large computer installations, are available. In addition, both data and program files can be accessed through a BASIC program. To add more versatility, flexibility, and performance for your application, both sequential and random access file structures are supported.

Virtual Micro™, available with any computer system purchased through itty bitty, contains a mainframe, 8" floppy disk, and 32K static memory. Write or call for quotes

IMSAI CABLES

Catalog Order No.	Description	Unit Price
CABLE A	18" flat cable to carry signals from SIO 2-1, 2-2 and MIO interfaces to cabinet backframe.	\$ 18.00
CABLE B	Flat cable connects parallel I/O board to rear of computer mainframe chassis for peripheral device.	\$ 29.00
CABLE C	4H" cable to connect floppy disk drives, modems, or terminals.	\$ 25.00
CABLE D	5' extension for CABLE C	\$ 35.00
CABLE H	18" flat cable for Shared Memory Facility	\$ 45.00
CABLE L	Video cable to connect VIO board cabinet backframe.	\$ 20.00
CABLE M	Cable set which connects MIO board to cabinet backframe for cassette recorder.	\$ 12.00
CABLE R	5' flat cable which connects 3 ports of PIO-6 board to breadboard system.	\$ 35.00
CABLE S	5' flat cable which connects data and address lines of PIO-6 board to breadboard system.	\$ 25.00
CABLE Z	6' flat cable for Shared Memory Facility	\$ 45.00
CABLE AF	18" flat cable to connect MPU-B board to cabinet backframe.	\$ 18.00

IMSAI DOCUMENTATION CHAPTERS

Catalog Order No.	Unit Description	Price
IM4K	4K BASIC Source Listing w/paper tape	\$ 14.00
IM8K	8K BASIC Source Listing Only	\$100.00
IM9K	9K BASIC Source Listing Only	\$100.00
IMAP	AP-44	\$ 5.00
IMCB	Commercial BASIC	\$ 5.00
IMCP	CP-A	\$ 5.00
IMDA	DOS-A (CP/M) Assembler	\$ 5.00
IMDD	DOS-A (CP/M) Dynamic Debugging Tool (DDT)	\$ 5.00
IMDE	DOS-A (CP/M) Editor	\$ 5.00
IMDI	DOS-A (CP/M) Interface Guide	\$ 5.00
IMDS	DOS-A (CP/M) System Alteration Guide	\$ 5.00
IMFIF	FIF (IFM-FIB)	\$ 5.00
IMFPD	FPS-D	\$ 5.00
IMFPU	FPS-U	\$ 5.00
IMIFM	IFM	\$ 5.00
IML	LIF (IFM-LIB)	\$ 5.00
IMMI	MIO	\$ 15.00
IMMB	Motherboard(EXP 6 & 22)	\$ 5.00
IMMP	MPU-A	\$ 5.00
IMPG1	PGM 1A (SCS-1)	\$ 5.00
IMPG2	PGM 2A (TCOS)	\$ 5.00
IMPG6	PGM 6A (SCS-2)	\$ 5.00
IMPC	PIC-8	\$ 5.00
IMPI4	PIO 4	\$ 5.00
IMPI6	PIO 6	\$ 5.00
IMP28D	PS-28D	\$ 5.00
IMP28U	PS-28U	\$ 5.00
IMPR4	PROM-4	\$ 5.00
IMR4	RAM 4A	\$ 5.00
IMSIO2	SIO 2	\$ 5.00
IMVIO	VIO	\$ 15.00

THE VERSATILE INFORMATION

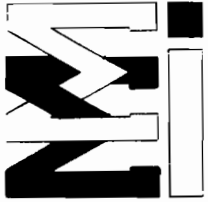

PROCESSING SYSTEM — VIPS-8000

System & Software, Inc.

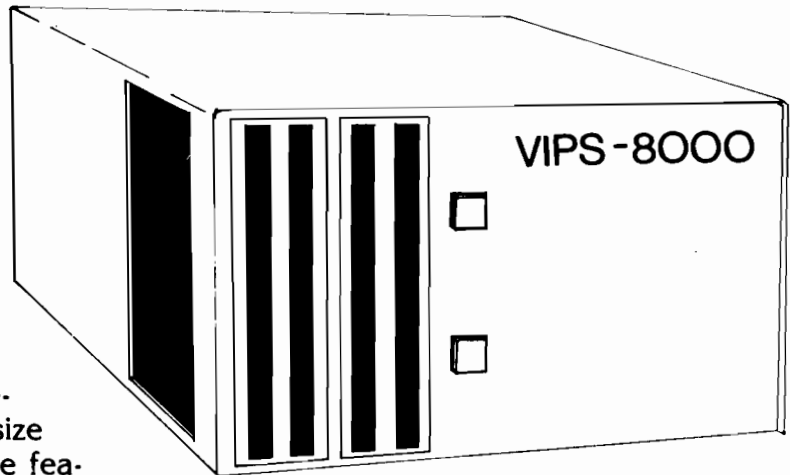

System & Software, Inc. proudly announce the VIPS-8000, a fully integrated system design especially suitable for small to medium-size business application. The hardware features a powerful 8-bit microprocessor with 48K of memory, expandable to 65K, terminal and printer interfaces, floppy disc based mass storage with storage capability up to 1MB, and a powerful file management system that provides broad control and access to the data you need for timely and accurate decision-making.

The VIPS-8000 runs under the control of the Virtual Micro™ Software, giving effective multi-user, multi-terminal operation in a resource sharing environment. Up to four terminals can be supported, and the printer output is spooled.

In addition, a Business System Library is developed for the VIPS-8000 as an integrated series of application software packages which are organized in modules. As the user's business grows, modules from our standard library can be selectively integrated into the user's current system. This enables the user to tailor the VIPS-8000 system to his specific and unique business needs. Thus, applications such as General Ledger, Accounts Payable/Receivable, Job Costing, Labor Distribution, Inventory Control, Payroll, Order Entry and Text Processing/Mailing Labels can all easily be customized and integrated under the VIPS-8000.

Please contact us for further information , price quotations , and delivery dates.

PCS-80 MAINFRAMES WITH INTEGRATED PERIPHERALS

CRT 8085 MICROPROCESSOR *PSC-80/30*

Catalog Order No. <i>PSC-80/30K</i>	
CRT 8085 Kit	\$1199.00
Catalog Order No. <i>PSC-80/30A</i>	
CRT 8085 Assembled	\$1499.00

Table top version of basic computer system with 5 inch CRT. Includes MPU-B, PS-28, VIO-C, IKB-1, and necessary cables. 10 card capacity.

SINGLE FLOPPY 8085 MICROPROCESSOR *PSC-80/34*

Catalog Order No. <i>PSC-80/34K</i>	
Floppy 8085 Kit	\$1649.00
Catalog Order No. <i>PSC-80/34A</i>	
Floppy 8085 Assembled	\$1899.00

Table top version of BASIC computer system with one minifloppy DISK DRIVE. Includes MPU-B, DIO, PS-28 and necessary cables. 10 card capacity.

DUAL FLOPPY 8085 MICROPROCESSOR *PSC-80/35*

Catalog Order No. <i>PSC-80/35K</i>	
Dual Floppy 8085 Kit	\$1995.00
Catalog Order No. <i>PSC-80/35A</i>	
Dual Floppy 8085 Assembled	\$2245.00

Table top version of basic computer system with two minifloppy disk drives. Includes MPU-B, DIO, PS-28 and necessary cables. 10 card capacity.

COMPONENT SYSTEMS

PERSONAL 8085 CASSETTE SYSTEM *PCS-80/100*

Catalog Order No. <i>PCS-80/100K</i>	
8085 Cassette System Kit	\$1886.00
Catalog Order No. <i>PCS-80/100A</i>	
8085 Cassette System Assembled	\$2670.00

Basic personal cassette system consists of a PCS-80/30, MIO, 8K Cassette BASIC, PGM-2A and RAM 16. Includes necessary cables. (Requires audio cassette recorder.)

PERSONAL 8085 DISK SYSTEM *PCS-80/200*

Catalog Order No. <i>PCS-80/200K</i>	
8085 Disk System Kit	\$2610.00
Catalog Order No. <i>PCS-80/200A</i>	
8085 Disk System Assembled	\$3357.00

Basic personal disk system consists of a PCS-80/34, IKB-1, RAM 16, VIO-B and DOS-A. Includes necessary cables. (Requires a TV monitor.)

PERSONAL 8085 CASSETTE SYSTEM II *PCS-80/300*

Catalog Order No. <i>PCS-80/300K</i>	
8085 Cassette System II Kit	\$2686.00
Catalog Order No. <i>PCS-80/300A</i>	
8085 Cassette System II Assembled	\$3732.00

Intermediate personal cassette system consists of a PCS-80/30, RAM 32, AP-44, MIO and 8K Cassette BASIC and PGM 2-A. Includes necessary cables. (Requires audio cassette recorder.)

PERSONAL 8085 DISK SYSTEM II *PCS-80/400*

Catalog Order No. <i>PCS-80/400K</i>	
8085 Disk System II Kit	\$3881.00
Catalog Order No. <i>PCS-80/400A</i>	
8085 Disk System II Assembled	\$4915.00

Intermediate personal disk system consists of IKB-1, RAM 32, AP-44, VIO-B, PCS-80/35, DOS-A and Commercial BASIC. Includes necessary cables. (Requires a TV Monitor.)

INTEGRATED SYSTEMS IMSAI VDP-80

The IMSAI Video Data Processor (VDP-80) is a compact, single-cabinet, stand-alone computer/intelligent terminal with dual floppy disk storage. The latest microprocessor design features allow the VDP-80 to fill the range of information processing needs for small businesses through major corporations.

In the small business environment, the IMSAI VDP-80 will provide management personnel the information they require to stay ahead in today's competitive business climate. For the larger business with an existing computer, it provides the means to implement Distributed Data Processing with real local processing capability on a highly cost effective basis.

The IMSAI VDP-80 comes fully assembled, tested and ready to run your applications programs. The basic configuration consists of a 12 inch CRT, dual PerSci floppy disks (250K each or 512K each diskette), 32K bytes of RAM memory, and a full function microcomputer based alphanumeric keyboard with 10 key numeric pad and control keys. The VDP-80 allows you to configure your system to meet your specific needs. Memory may be expanded to 196K bytes in 16K byte increments. Under program control, the dual PerSci floppy disks are capable of storing 512K bytes or one megabyte each. Optionally, another dual floppy double density disk unit can be added to the system to give you an additional 512K bytes on each diskette for a total of 2,000,000 bytes of on-line storage! Interface support included in the VDP-80 will support various hard copy devices including the letter quality Diablo

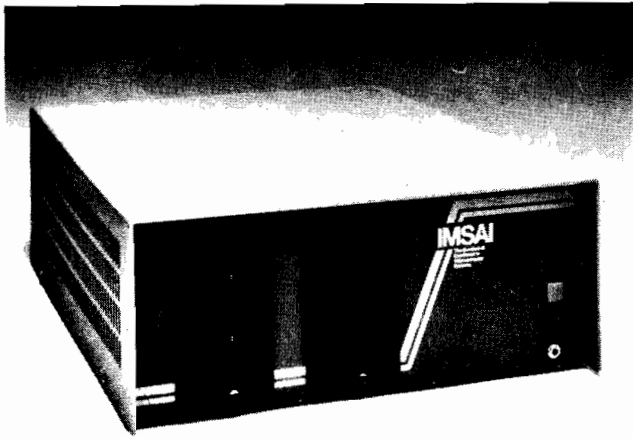

MSAI Computer

HyType II at 45 CPS through the teletype Model 40 line printer at 300 LPM. Optionally the included serial interface can be used to connect to a modern serial interface can be used to connect to a modem to drive other terminals or to connect the VDP-80 into a data communication network.

Software provided with the VDP-80 comprises a comprehensive array of operating system capabilities within the context of high level languages such as our extended and commercial BASIC or level II ANSI Fortran IV, and an Assembler with relocatable code, linking loader, file management, disk space management, etc. This complement of software allows you to program the sophisticated applications you need and/or convert programs from outdated and less cost effective computers.

Special features unique to the VDP-80 are provided by the IMSAI VIO and IMSAI MPU-B. The 12" display capacity is 80 characters per line by 24 lines. Protected field formatting in inverse video combined with character and line insert/delete provides the data entry and text editing capabilities required for business applications. For foreign and special purpose text editing applications, the character set may be reprogrammed in any combination of 256 different characters. A 2K ROM monitor provides extensive debugging and diagnostic test capability.

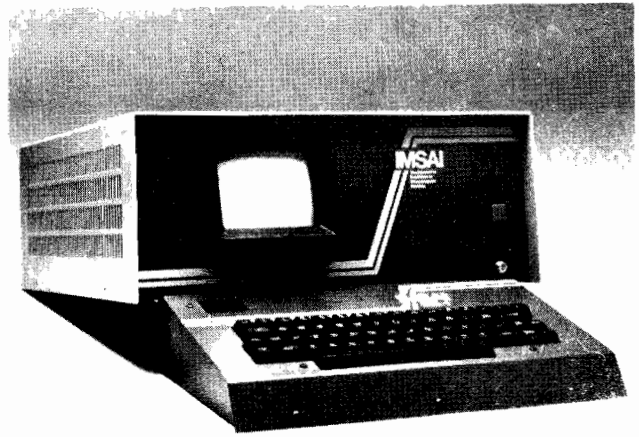

The MPU-B features the 8085 microprocessor chip which operates standard memory at a 50 or 70 per cent higher throughput rate due to its three megahertz clock cycle and more efficient internal instruction processor. Additionally, the MPU-B comes with parallel and serial I/O ports. The input side of the parallel port handles the keyboard. The output side can be used to drive a printer or a plotter. The serial port support the synchronous (including bisyne) and asynchronous communications with programmable baud rates from 56 baud to 19.2 kilobaud, and may be used to drive a MODEM, line printer, terminal or other RS-232 or current loop compatible device.

Catalog Order No. VDP-80/1000
VDP System Assembled \$5995.00

Video Data Processor. Integrated computer system with 12 inch CRT, keyboard, dual PerSei floppy disk, and mainframe with 8085 processor, 32K of RAM memory and all interfaces housed in single table-top cabinet (must order DOS-A).

Catalog Order No. VDP-80/1050
VDP System Assembled \$6745.00

Same as VDP-80/1000 with 64K of RAM memory.

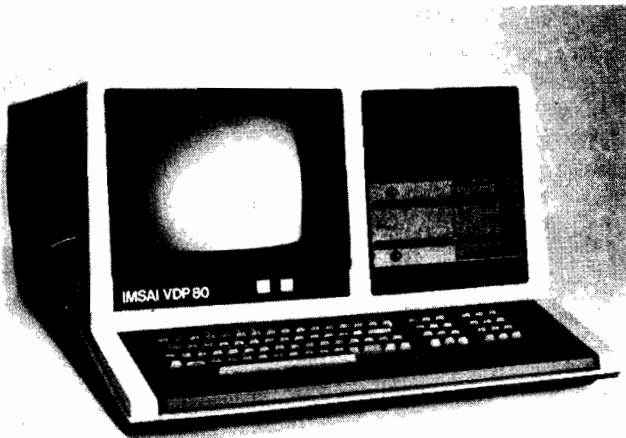

DUTRONICS

280-80 piggy back card for your existing IMSAI or ALTAIR

THE DZ80-80 CPU

Z80-80 piggy back card for your existing IMSAI or ALTAIR
Introduction

The DZ80-80 is a 4-inch square "Piggyback" PC card designed to upgrade and 8080/8080A CPU microprocessor based system to a Z-80 CPU system without requiring replacement of the system processor card. The Z-80 CPU is NOT electrically interchangeable with the 8080 CPU and has meant, until the DZ80-80, that to obtain the power of the nearly 690 instruction variations of the Z-80, the 8080 processor card had to be discarded.

Nine integrated circuits and a bevy of passive components provide a network which interface the Z-80 CPU to the system's existing 8080 socket. An umbilical cord connects from the DZ80-80 to the system's existing 8212 status latch socket. Thereby providing Z-80 power by replacing only two ICs.

It is recommended that all included reference material be read prior to the installation of the DZ80-80. Since the Z-80 IC included is an MOS device, improper handling or installation can become an expensive education.

THE Z-80 CPU

Included is the 'Z-80 Technical Manual' written by the Z-80 design team. A thorough study and understanding of this Manual is a must to obtain full benefit of Z-80 POWER.

COMPATABILITY

AS A SUBSET OF THE Z-80 INSTRUCTION SET IS THE 8080 INSTRUCTION SET. THEREFORE, PROGRAMS WRITTEN FOR THE 8080 WILL EXECUTE IDENTICALLY.

As a subset of the Z-80 instruction set is the 8080 instruction set. Therefore, programs written for the 8080 will execute identically on the DZ80-80 system with one minor exception.

The Parity flag of the 8080 is shared by a new Overflow flag on the Z-80 (see 'Z80 Technical Manual' for description). Some sophisticated software writers have been known to store information in the Parity flag to react differently on the Z-80 than the 8080. Therefore, in one or two rare instances, where the Parity flag is used for other than Parity, a minor incompatibility could exist (ALTAIR Basic is one rare instance). This is the only inconsistency found after extensive research.

Another difference between the DZ80-80 provides the user

Another difference between the DZ80-80 and the 8080 is that there is no provision for STACK status. As of this writing, no known hardware is available that would be inoperative without STACK status.

As a consolation the DZ80-80 provides the user an option to connect the STACK status line to the Z-80 Refresh signal, thereby allowing the DZ80-80 to perform all necessary refreshing of the system's dynamic memory.

One final note on compatibility is when operating the DZ80-80 in an IMSAI, ALTAIR or other systems with a hardware front panel that is supposed to stop (when STOP is pressed) on an MI cycle only, the DZ80-80 may stop on any random machine cycle. This occurs when the front panel samples the data lines during SYNC to decode MI status rather than using the STATUS lines themselves. The DZ80-80 does not place STATUS on the data lines.

Panel switches EXAMINE, EXAMINE NEXT, DEPOSIT and DEPOSIT NEXT do not operate correctly unless the processor is in an MI cycle. It is thus required to single step the processor to an MI cycle before operating the previously mentioned panel switches after a STOP. (RESET while STOP will always generate an MI cycle.)

This idiosyncrasy has been found not to be a problem once the operator becomes used to checking for MI before pressing EXAMINE. It was felt that the extra cost that would have been incurred by the end user did not warrant the addition of hardware to eliminate this inconvenience.

DZ80-80 THEORY OF OPERATION

As noted in the 'Technical Manual' the Z-80 does not provide many of the signals required for the operation of an 8080 system. Namely SYNC, INTE, DBIN, INTA, OUT, IMP and MEMR had to be generated from the Z-80 System Control Signals IORQ, MREQ, RD and MI.

The system $\phi 2$ clock was chosen to generate the clock for the Z-80 since the specification for $\phi 2$ is compatible with the 8080.

The system $\phi 2$ clock was chosen to generate the $\phi 2$ clock for the Z-80 since the specification for $\phi 2$ is compatible with the 8080 clock specification and no system timing change occurs for this choice. $\phi 2$ is a 12V clock, unlike the 8080 the Z-80 requires a single 5V supply and no high voltage clocking. Diode CR1 and resistor R1 shift the $\phi 2$ clock to a 5V signal which is double inverted by IC5 and derives $\phi 1$ with pull-up resistor R2. R2 is included to insure that $\phi 1$ has a High of 5V as required by the Z-80.

System SYNC (beginning of each machine cycle) is created as one $\phi 1$ period beginning when both IORQ and MREQ are False by NAND gate IC3, inverter IC5 and JK flip flop IC6 clocked by $\phi 1$ IC5 output, SYNC, is used to gate WR and WO to insure that time is available for the system to decode OUT status before WR becomes active during a write operation.

Status INP is the AND of RD and IORQ implemented by NOR gate IC7. Status OUT is IORQ ANDED with WR using NOR gate IC4. The status signal INTA is MI and IORQ with NOR gate IC4 acting as the AND function.

Status MEMR is formed with NOR gate IC7 as RD AND MREQ. The remaining two implemented status signals, MI and HALT, are merely the inversion of Z-80 outputs MI and HALT by IC2 and IC3 respectively.

The Z-80 does not provide any indication where it is performing a STACK operation, therefore, the STK status has not been provided. The DZ80-80 is assembled with a jumper from the STACK status input to ground. At the user's option this jumper may be connected to the Z-80 RFSH output thus providing the system with automatic dynamic memory refresh. See 'Z80 Technical Manual' for a discussion of this subject.

No external indicator is provided by the Z-80 as to the state of the internal Interrupt Flip-Flop. Thus NAND gate IC1, Inverters (2) IC2 and NORS (2) IC4 decode each EI and DI instruction on the falling edge of MI and store this information in Flip-Flop IC6 providing the INTE signal. System RESET or Status INTA will set IC6 through NOR gate IC7 indicating INTE False. IC7 then parrots the state of the internal Z-80 interrupt Flip-Flop.

DBIN is implemented as RD or INTA by NAND gate IC3 and NOR gate IC7. Notice that DBIN is true also during System RESET. This is not a system requirement but included only to save an IC package. It was determined that DBIN True at RESET time would not degrade performance and create a physically smaller DZ80-80 assembly.

A potentially powerful feature of the Z-80 is its handling of the high order address lines during I/O operations, refer to the 'Technical Manual' for a discussion. Most existing 8080 systems, however, have used A8 through A15 for I/O addressing and this feature could not be included in the DZ80-80. (If this feature is desired IC8 and IC9 can be removed and A8 through A15 strapped straight through.)

Multiplexers IC8 and IC9 are connected between the Z-80 and 8080 system address lines, such that during status, INP or OUT NOR Gate IC7 causes A8 through A15 to contain the same data as A0 through A7.

The Z-80 NMI (Non-Maskable interrupt) line has been brought to a solder pad on the DZ-8080 so the user may connect this, to say VIC. This connection would mean V IO is the ultimately highest priority interrupt.

As noted on the DZ80-80 schematic the remainder of the Z-80 to 8080 system interface is either by straight connection or by simple inversion and need not be dwelled upon.

With the exception of the eight status lines (and NMI) all DZ80-80 connections are made through the system's 8080 socket. Connector I2 provides the connection of the status to the system via Plus P2, 8 conductor flat cable, 24-pin

connector, connector J3 to the system 8212 status latch socket (8212 is removed). The flat cable is permanently attached and wired to J3 pins 4, 6, 8, 10, 15, 17, 19, and 21, the output pins of the 8212.
Marked on J2 are two different positions. P2 can be plugged in. POSition A and Position B:

POS A - ALTAIR Position
POS B - IMSAI Position
In the event another pin-out is required, the pins of plug P2 may be removed and scrambled to fit the user's requirements (see INSTALLATION and CHECKOUT section).

Catalog Order No. DZ80-80

Assembled Z-80 Board, Technical Manuals, System Monitor on Paper Tape

\$159.95

THE SPACE BYTE 8085 CPU

As the dedicated controller with its own software development system

Applications for dedicated system controllers are virtually limitless. The SPACE BYTE 8085 CPU is a complete dedicated system controller because it has full I/O capability, 256 bytes of RAM, 14 bit binary interval timer/counter, 3MHz operational speed and the capacity for 3K or 6K of on board application firmware. Additionally, the SPACE BYTE 8085 CPU will serve as the heart of its own software development system when installed in a S-100 type mainframe. With the optional SPACE BYTE 2708/2716 EPROM PROGRAMMER, application firmware can be developed and tested on the very device for which it was conceived.

By inserting programmed EPROMS in the sockets on board the SPACE BYTE 8085 CPU, the dedicated controller can now be tested "as itself," while still installed in the S-100 mainframe.

The SPACE BYTE 8085 CPU and increments of 16K SPACE BYTE fully static memory offer perhaps the most innovative, versatile and cost effective software development system in the industry.

The SPACE BYTE 8085 is:
a self contained computer
a software development system
a dedicated controller

SPACE BYTE 8085 CPU SPECIFICATIONS

This CPU card provides all facilities necessary for operating a Disk system, console CRT, and high speed serial EIA printer. It is delivered complete with Tape and Disk software PROM resident.

CARD SIZE: 5.1 x 10 x .6
COMPATABILITY: S-100 Bus
ON CARD MEMORY: RAM 256 x 8
EPROM 3072 x 8 (2708) Standard
EPROM 6144 x 8 (2716) Optional
PROCESSOR TYPE: INTEL 8085
OPERATING SPEED: 3MHz operation, using 450ns memory
1.302 microsecond minimum instruction cycle time.
Crystal = 6.144 MHz
PARALLEL I/O: 8155 Parallel I/O /Timer/Counter/RAM Terminated on 50 pin header pinned for ICOM FC-360 Disk controller
1—8 bit unlatched input port
2—8 bit latched/buffered output ports
1—6 bit input/output/handshake port
SERIAL I/O: 8251 USART
CRT RS232C 110-9600 BPS
Self seeking baud rate selection
110-150-300-1200-1800-2450-4800-9600 BPS
Printer RS232C 110-9600 BPS
Software speed select
51D/50D RS232C buffers provided
2 ea. 26 pin headers complete with 12" extention cables to rear panel, terminated in 25 pin female data connectors.
INTERRUPT: 4 Vectored priority interrupts
POWER REQUIREMENTS: Standard (2708 EPROM)
+8v @ 430 MA
+16v @ 110 MA
-16v @ 120 MA
Optional (2716 EPROM)
+8v @ 470 MA
+16v @ 35 MA
-16v @ 80 MA

SYSTEM MONITOR COMMAND TABLE

Reset and Initialization

"A" Automatically selects baud rate for which CRT is set (110-9600 baud)
Seeks and displays high address of usable RAM

After Initialization

"A" Assign Assigns list device (CRT or Printer)
"B" Boot Loads disk executive
"C" Compare Compare PROM to RAM
"D" Dump Display memory contents
"E" Tape-Execute Load and execute program from Tarbell Cassette
"F" Fill Fill memory with constant
"G" Go Go to RAM location XXXX (with break points)
"H" Hexarith Hexidecimal arithmetic function
"I" Inspect Inspect and change memory
"J" Jump Jump to location 0000
"L" Tape-Load Load only from Tarbell Cassette
"M" Move Move a block of memory
"N" Null Set nulls to printer
"P" PROM Program PROM
"R" Registers Examine and change CPU registers
"S" Speed Set baud rate to Printer
"T" Transfer Transfer PROM to RAM
"V" Verify Check sum verification of mag tape
"W" Write Write file to Tarbell Cassette

Video driver routines resident in system monitor for Polymorphic video module enables use of video terminal instead of CRT. System monitor searches for "A" after reset to assign console device.

ERROR TABLE:
Check sum error
File size error
Disk full
Disk not ready
Key board error

DYNABYTE

The Features & Benefits of a Great Memory

TRANSPARENT REFRESH

The 4K dynamic memory chips employed by the 16K module are organized internally as 64 columns of 64 bits. Each column must be refreshed at least once every 2 ms, which results in column refreshes at intervals of about 30us. When this interval has elapsed and a column must be refreshed, the refresh will actually be delayed until the next regular memory cycle has occurred. Immediately following this memory cycle the refresh will be performed and the refresh will be complete before the 8080 can access memory again. In this way, refreshes will be performed without interfering with 8080 operation. It is never necessary to make the 8080 WAIT. Refresh operation is fully automatic, self-contained, and transparent to the 8080 system.

INTERNALLY GENERATED TIMING

The clock and control signals the 4K dynamic memory chips must be precisely controlled to guarantee reliable operation with various "compatible" systems, each of which actually has a few quirks of its own. All control signals for the dynamic RAM chips are generated on the 16K RAM Module itself from a 20MHz crystal controlled oscillator. Consequently, the timing of control signals to the RAM chips is perfectly repeatable and cannot be influenced by variations in the timing of signals from the host system. The host system starts a cycle rolling and from that point on all

timing functions are keyed to the on-board crystal oscillator. There are no RC's to drift, no one shots to misfire and no dependence on a tight relationship between $\phi 1$ and $\phi 2$. Self-contained and independent control logic means a simple, trouble-free, and reliable memory system.

RIGOROUS BURN-IN AND TESTING

Each module is initially tested (and debugged if necessary) using diagnostic software including (but not limited to) WALKPAT, MARCH and various processing pattern routines. These tests confirm complete functionality of the module in both normal and DMA operation. Next, each module enters a 72 hour burn-in cycle at 70°-75°C during which memory diagnostics are run and all errors are automatically logged. Any failures, including soft errors, cause the module to re-enter the burn-in cycle after the offending parts have been replaced. In addition, just prior to shipment, each module must pass a final Quality Control Test which again checks complete functionality. This rigorous testing results in a level of memory reliability previously unavailable for the S100 bus..

DMA CONTROL

Direct memory access is provided by means of control logic completely separate from the 8080 control logic. Only SMEMR, PSYNC, and PWR are needed by this

DMA control logic, thereby facilitating simple DMA interfacing. Similar to normal operation, refreshes are performed immediately following a DMA access and are, therefore, transparent to the DMA device. This imposes a maximum instantaneous DMA transfer rate

of 1 MHz, higher than required by floppy disks and most other peripherals.

catalog Order No. DYN16D
16K Dynamic RAM Assembled \$399.00

SPECIFICATIONS

Storage Capacity	16384 Bytes
Addressing	16K Boundaries
Buffering	200uA max.
(All address and Data)	
Access Time	
from ϕ_2	200 ns
from address setup	350 ns
Cycle Time	500 ns
Refresh Interval	=10us
Over-refresh Factor	=3x
Wait States Generated	None
DMA Rate	1 MHz max. 33 kHz min.
Power Consumption	
Operation	
+16 v	150 ma (avg.)
+ 5V	500 ma (typ.)
- 5V	20 ma (max.)
During a WAIT state	
+16V	15 ma (avg.)
+ 5V	500 ma (typ.)
- 5V	20 ma (max.)
Ambient Operating Temperature	70°C (max.)

COMPATABILITY

- Mainframes**
 IMSAI 8080
 POLY 88
 ALTAIR 8800
 SOL
 BYTE 8
 VECTOR GRAPHICS
 Dutronix DZ80
- Disks**
 Digital Systems
 North Star
 Micropolis
 Altair
 ICOM

DYNABYTE INC.

What a FULLY STATIC memory means to YOU

A fully static RAM requires no clocks or timing signals. Its cycle time is identical to its access time and its access time is a function of internal propagation delays from address setup to data output. Its only control signals are:

- a) Write enable, and
- b) Chip select, which is usually decoded from the higher order address bits.

Either of these signals may be held in any logic state for any length of time, contrary to either a semistatic or a dynamic RAM.

A fully static RAM is, therefore, simple to use and

should never present any compatibility problems for the S100 bus, as long as its access time is fast enough for the particular processor in use. This makes a fully static RAM the most desirable type of memory in terms of trouble-free operation and interfacing.

RIGOROUS BURN-IN AND TESTING

Every Dynabyte memory module is tested and debugged using diagnostic hardware and software designed to identify soft errors and pattern sensitivity as well as hard errors. After initial testing, each memory module enters a 72-hour (minimum) burn-in cycle at 70°-75°C during which diagnostics are run and all errors are automatically logged. Any failures cause the module to re-enter the burn-in cycle after the offending parts have been replaced. In addition, just

Storage Capacity	16,384 Bytes
Addressing	Each 4K Block may be located on 4K boundary
Buffering	a) Schmitt triggers on all addresses and control inputs b) Data buffered in and out
Access Time	
Model 1625	294 nsec max (Compatible with 4 MHz Z80)
Model 1645	494 nsec.
Cycle Time	Same as access time
Wait States	None
DMA	No Restrictions
Power Consumption	
Model 1625	2.4 A at 8.0 VDC (Nominal)
Model 1645	1.8 A at 8.0 VDC (Nominal)
Supply Voltage Range	
Minimum	7.0 V (Instantaneous)
Maximum	A function of Ambient Temperature: 11.0 V at 70°C (see derating curves in manual)
Ambient Operating Temperature	70°C (Max)

prior to shipment, each module must pass a final Quality Control Test which checks complete functionality once again. This rigorous testing results in a level of reliability suitable for industrial data processing. It also allows us to guarantee the memory module against defects in materials and workmanship for a period of 1 year from the date of purchase.

Catalog Order No. DYN16S
16K Static RAM Assembled \$555.00

ADDITIONAL FEATURES

Write Protect—Each 4K block of memory may be individually write-protected by means of switches located on the memory module. If an attempt is made to write into a protected area, both an audible and a visible alarm will be activated.

Bank Select—The memory module may be located in any one (or more) of eight possible "Banks" by means of switches mounted on the memory module. Software may then control which of these eight Banks is active. This allows up to eight 64K memory Banks to reside in the same system. Software control of the active bank is implemented by means of an output port which comes set up at address 42H but which may be located anywhere. The data sent to this output port will activate one or more of the eight possible banks and the memory modules addressed to these Banks will then be enabled.

A fully static RAM requires no clocks or timing signals. Its cycle time is identical to its access time and its access time is a function of internal propagation delays from address setup to data output. Its only control signals are:

- a) Write enable, and
- b) Chip select, which is usually decoded from the higher order address bits.

Either of these signals may be held in any logic state

and should never present any compatibility problems for the S100 bus, as long as its access time is fast enough for the particular processor in use. This makes a fully static RAM the most desirable type of memory in terms of trouble-free operation and interfacing.

RIGOROUS BURN-IN AND TESTING

Every Dynabyte memory module is tested and debugged using diagnostic hardware and software designed to identify soft errors and pattern sensitivity as well as hard errors. After initial testing, each memory module enters a 72-hour (minimum) burn-in cycle at 70 -75 C during which diagnostics are run and all errors are automatically logged. Any failures cause the module to re-enter the burn-in cycle after the offending parts have been replaced. In addition, just prior to shipment, each module must pass a final Quality Control Test which checks complete functionality once again. This rigorous testing results in a level of reliability suitable for industrial data processing. It also allows us to guarantee the memory module against defects in materials and workmanship for a period of 1 year from the date of purchase.

THERMAL DESIGN

The 32K Fully static Memory Module packs a lot of memory onto one board. Consequently a lot of heat is generated and must be dissipated into the surrounding environment to ensure proper operation of the memory module at elevated temperatures. The 32K Fully Static Memory Module utilizes eight regulators and heat sinks, each one carrying part of the burden, in order to assure reliable operation at 70 C. This arrangement maintains the voltage regulators at a temperature well below the limit recommended by their manufacturers for maximum reliability.

Catalog Order No. DYN32
32K Static RAM Assembled \$995.00

SPECIFICATION

Storage Capacity	32768 Bytes
Addressing	4K boundaries
Buffering	a) Schmitt triggers on all address and control inputs b) Data buffered in and out
Access Time	
Model 3225	294 nsec max. (Compatible with 4 MHz Z80)
Model 3245	494 nsec max.
Wait States	None
DMA	No Restrictions
Power Consumption	
Model 3225	4.20 A at 8.0 VDC (Nominal)
Model 3245	2.95 A at 8.0 VDC (Nominal)
Supply Voltage	
Minimum	7.0 V (Instantaneous)
Maximum	A function of Ambient Temperature 11.0V at 70 C (see derating curves in manual)
Ambient Operating Temperature	70 C (Max)

SpeechLab™

by HEURISTICS , INC.

Use SpeechLab to directly control any S-100 Bus Computer such as Sol, IMSAI, Altair and so on. SpeechLab digitizes and extracts data from speech wave form and applies pattern matching techniques to recognize the vocal input. Response is real time. The system features 64 bytes of storage per spoken word and can handle up to a 64 word vocabulary. And recognition after very little practice is 95 percent or better.

Includes a complete hardware/software system, a 275 page laboratory manual, 95 page hardware manual and high fidelity microphone.

The lab manual includes 35 graded experiments with over 100 tables and graphs. In fact, it's the only introductory volume on speech recognition currently available.

includes Speech Basic programming language in source and paper tape, assembly language speech recognition program in source and paper tape, hardware self-test program in source and paper tape. Speech Basic plot, correlation, recognition and advanced recognition programs are offered in source.

**You can't get better quality
You can't get more performance**

Sure, more complex, higher price equipment is available for about 50 times more money. It won't do much more than you can do with SpeechLab. And the quality and state-of-the-art engineering can't be any better. We use CMOS design for low power and ultimate reliability.



FEATURES

- Complete hardware/software system
- 275 page laboratory manual
- 95 page hardware manual
- 100 tables and diagrams
- Speech recognition tutorial
- 35 graded experiments

- 64 bytes of storage per spoken word
- S-100 compatible
- High Fidelity Microphone
- 200 millisecond response
- Automatic hardware self test capability
- Advanced C-MOS design/low power consumption
- 95% correct recognition

SOFTWARE

- SpeechBasic Basic programming language Source and paper tape
- Assembly language speech recognition program Source and paper tape
- SpeechBasic plot program Source
- SpeechBasic correlation program Source
- SpeechBasic recognition program Source
- SpeechBasic advanced recognition program Source
- Hardware self test program Source and paper tape

Catalog Oder No. HSLK

SpeechLab Kit \$249.00

Catalog Order No. HSLA

SpeechLab Assembled \$299.00

MULLEN COMPUTER BOARDS EXTENDERBOARD with built-in LOGIC PROBE

WHY AN EXTENDER BOARD: When many boards are loaded side-by-side into a computer, troubleshooting becomes almost impossible. This useful accessory "extends" a given board over the tops of other boards for easy troubleshooting and examination. Almost every computer owner will at some point need one of these, and there are many reasons to choose Mullen.

- 1 Compatible with the S-100 bus scheme used by Altair, IMSAI, and over a dozen other manufacturers.
- 2 Built-in TTL logic probe indicates low level logic (green LED), high level logic (red LED), and high/low transition or pulse (yellow LED remains lit for about .2 second to catch short pulses). The probe itself uses a "phono needle" type point for secure, nonskid contact.
- 3 Specially designed edge connector allows use of clip lead probing; edge connector label identifies pin numbers, locates power and ground connections.
d size, full width board takes advantage of the S-100 card guide system.
- 4 Jumper links in power lines (8V, 16V, -16V) allow easy current measurement and fusing of the board under test; by adding a switch you may shut down board power without turning off your computer.
- 5 Naturally, a piece of equipment used for service and development should be reliable — towards that end we use plated through holes, solder plate traces over 1 oz. copper, 50 micro-inch gold plating on the connector teeth to maintain reliability after repeated insertions, and high quality components.
- 6 nstructions are not an afterthought, but are designed from the ground up to insure a properly assembled kit regardless of level of builder experience.
- 7 **Catalog Order No. MEBLPK**
Extender Board with Logic Probe Kit \$35.00
Catalog Order No. MEBLPA
Extender Board with Logic Probe Assembled \$46.00

Opto-Isolator/Relay Control Board

alarms, display lights, audio signal lines, and the like— is severely limited. This board controls low current devices directly, or triggers heavy duty power relays or

WHY AN OPTO-ISOLATOR/RELAY CONTROL BOARD: Although a computer may perform interesting operations and programs, its usefulness in controlling real world devices—such as motors, burglar triacs. Additionally, 8 opto-isolators accept an 8 bit word from the outside world and send it to the computer for handshaking or further control purposes.

You will find these boards valuable in plugging I/O gaps that prevent your computer from interacting with other devices. Model railroads, ham radio, music synthesizer, and hi-fi switching applications — as well as many others — may now be brought directly under computer control.

The Board offers the following features:

- 1 Compatible with the S-100 bus scheme used by Altair, IMSAI, and over a dozen other manufacturers.
- 2 Unambiguous operation: Eight reed relays response to an 8 bit word. Feed the relay associated with its bit a "1" and it closes, give it a "0" and it opens.
- 3 On board regulation.
- 4 Reliable design uses low power Schottky support ICs for fast, low power operation. Edge connector fingers are gold plated for optimum connector contact. An epoxy glass, double sided, plated through board contributes to reliability and ease of assembly.
- 5 Dipswitch selects I/O port address.
- 6 Figure 1 shows tradeoffs for power handling capacity and contact voltage for the reed relays. The contacts are rated for several million cycles; however, the greater the load on the contacts the shorter their life.
- 7 Mullen instructions are not an afterthought, but are designed from the ground up to insure a properly built kit regardless of level of builder experience.

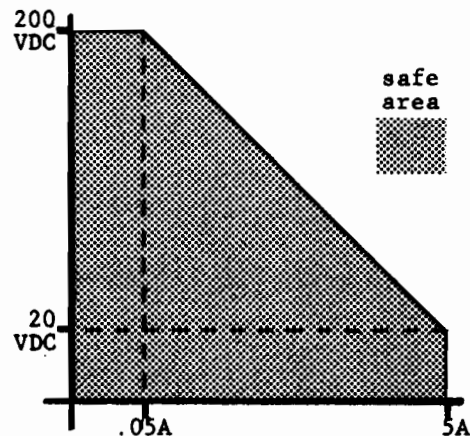

FIGURE 1-- REED RELAY CONTACT RATINGS

- Catalog Order No. MOIK**
Opto-Isolator/Relay Control Board Kit \$117.00
- Catalog Order No. MOIA**
Opto-Isolator/Relay Control Board Assembled \$153.00

iCOM[®] MICROPERIPHERALS[®]

FD3700 Series Floppy Disk System for Microcomputers



THE NEW STANDARD

The iCOM FD3700 Series Floppy Disk System for microcomputers continues in the fine tradition of the famous iCOM FD360 in use throughout the world. The FD3700 brings to the OEM, and to the development lab, proven reliability and popular features, while incorporating advanced styling and new convenience items. The FD3700 Series is the new standard to which other floppy disk systems will be compared.

FEATURES

- Fully IBM 3740 media and format compatible
- Full formatter and controller built-in
- Full sector Read/Write buffers allow asynchronous or DMA data transfer
- Drive and diskette Write Protect capability
- Positive latching door mechanism
- Up to 4 drives with no software or hardware modifications
- MTBF in excess of 2300 hours (FD3712 dual drive)
- Plug-in convenience allows MTTR of 18 minutes
- Front panel LED status indicators
- LED drive select indicators
- Fully retracting head and pressure pad for maximum diskette life
- 50 pin flat ribbon cable with 3M interface connector — FD360 compatible

PERFORMANCE SPECIFICATIONS

- Disk Speed 360 RPM \pm 1.5%
- 10 ms Track to Track Access Time
- 40 ms Head Load Time
- 5 ms Sector Read/Write Time
- 83 ms Average Latency Time
- 700 ms Automatic Head Unload Time
- 1 ms Interrecord Time

FULLY COMPATIBLE WITH iCOM SOFTWARE AND INTERFACES

Interfacing is easy using any of iCOM's plug-in interface and software packages for most popular microcomputers. For the OEM or development system application, iCOM interfaces are the convenient and economical answer. All iCOM interface packages are plug-in compatible with the FD360, the FD3712 and the popular iCOM Frugal Floppies.[™] For unique applications, a simplified general purpose TTL compatible interface is also available at no extra cost.

BUILT-IN COMMAND FUNCTIONS

iCOM's sophisticated controller features the following built-in command functions to simplify total system integration:

- SEEK AND VERIFY: Automatically Seeks Track and Verifies Track Address from ID Field on Diskette
- SEEK TRACK ϕ (Seek Track ϕ)
- SECTOR AND UNIT SELECT (Specifies Sector and Unit Number for Read/Write Operation)
- TRACK SELECT (Specifies Track to be used by next Seek)
- WRITE: (Writes the Contents of Write Buffer to the selected Sector and Unit on the existing track)
- READ (Reads the Contents of Selected Sector into Read Buffer)
- WRITE DELETED DATA ADDRESS MARK (Same as Write but uses header in Data Field which can later be detected in Read operation)
- READ CRC (Same as Read but no data is transferred to the Read Buffer. Used to verify integrity of data previously written)
- SHIFT WRITE BUFFER (Loads Data into Write Buffer)
- SHIFT READ BUFFER (Inputs Data from Read

Buffer)

- GATE STATUS (Gates Status of Data onto Input Data Lines)

POWER REQUIREMENTS:110-125 VAC, 60 Hz, 200 watts max.

CABINET DIMENSIONS:7.75 x 19.16 x 20.5 inches (H,W,D)
196.8 x 486.6 x 520.0 mm (H,W,D)

MICROFLOPPY™DISK SYSTEM

for:• IMSAI 8080 • Poly 88 • Altair 8800 and
other microcomputers with the S100
bus format.

THE MICROFLOPPY™ System has been specifically designed for the personal computer user. It uses the new 5¼ inch diskette, and its lower price includes the disk drive and its associated electronics, power supply, cabinet, controller/interface card, power supply, cabinet, controller/interface card, power cord, fuse and all cables and connectors. Also included on diskette is iCOM's famous FDOS-M software. In addition, an optional 8K disk BASIC software package is available at nominal cost.

The controller/interface card, which contains 42 IC's, including LSI components, has all of the electronics necessary to interface the Disk Drive and the Microcomputer, making the system 100% plug-in compatible with the IMSAI 8080, the Altair 8800, the Poly 88 and other microcomputers using the Altair S-100 bus format.

FDOS-M SOFTWARE

iCOM's FDOS-M software includes a macro assembler and a string-oriented text editor. Its features include named variable length files, auto file create, open & close, multiple file merge and delete. Under FDOS-M, programs stored on the diskette are assigned 5 character names by the operator. Up to 175 named files (programs) can be stored on a single diskette, each available within seconds. Each file can be as small as 128 bytes or as large as the entire diskette.

8K DISK BASIC SOFTWARE (BASIC-M)

An 8K disk resident BASIC software package is also available. The BASIC-M package is fully compatible with FDOS-M, the assembler and the editor. For example, the output of the editor can be used as input to BASIC-M and vice versa. Using BASIC-M, the operator can open and close data files, read and write from and to disk files, and can store and retrieve programs and/or data. BASIC-M is supplied on diskette as is FDOS-M, the assembler and the editor. No media conversion is required with iCOM.

SPECIFICATION

Format Specifications

- Media can be initialized by the user with a wide variety of formats; including the 128 bytes/sector, 16 sector/track IBM-like format used by the iCOM software.
- 35 tracks/diskette.

- Uses 5.25 in. (133 mm) diskettes available from iCOM and other sources.

Performance Specifications

- Formatted Capacity

Per disk

Per track

Per sector

Sectors/track

- Transfer rate

- Average latency time:

- Access time

Track to Track

Settling Time

- Head load time

- Drive motor start time

Functional Specifications

- Rotational Speed

- Recording Density (inside track)

- Flux Density

- Track Density

Power Requirements

115/230VAC, 50/60 Hz, 60 watts.

Cabinet Dimensions

3.80" H x 6.10" W x 12.9" D

(9.65 cm.)H x (15.5 cm.)x (32.77 cm.)D

Cabinet Weight

8 lbs. (3.63 kg.)

Interface/Controllers

- IMSAI 8080 (also compatible with TDL Z-80).
- Altair 8800 (also compatible with TDL Z-80).
- Polymorphic Systems Poly 88.

INTEGRATED CONTROLLER HEAD

GENERAL INFORMATION

iCOM's Integrated Controller/Interface for the Microfloppy™ is truly a state-of-the-art product. It features an LSI controller chip which uses IBM format standards. It's a hardware oriented controller, with little real time software required to control the disk. The controller can handle up to 3 disk drives, daisy chained and automatically selected by software.

Inputs to the disk drive from the controller are composite clock and data formatted. Output signals are composite clock and data which are then separated by the controller.

FEATURES

- Uses MOS LSI and low power Schottky technology for high reliability.
 - Onboard ROM and RAM minimize user memory requirements and facilitate system boot.
 - Single or Multiple record read/write with Automatic track seek with Verification.
 - Entire track read.
 - Entire track write for Diskette initialization.
 - Phase Locked Loop data separator for high data reliability.
- Compatible with iCOM's new FDOS-M, Assembler, and Editor software operating systems. Also works with iCOM's exciting new 8K disk BASIC-M.

Electrical and Mechanical Specifications

- TTL tri-state I/O.
- Housed on one 5.4 in. x 10.0 in. (13.72 cm x 15.4 cm) Altair/IMSAI/Poly 88 compatible PCB. Also works with Z-80.
- Onboard regulators require +16 V DC unregulated @10ma, -16 V DC unregulated @1ma, and +8 V DC unregulated @600ma. Power obtained from CPU bus.

INTERNAL REGISTERS

- Data (Read/Write)
- Track (Read/Write)
- Sector (Read/Write)
- Command/Status (Command Write Status Read)

Commands

- Restore
- Seek
- Step
- Step-in
- Step-out
- Read
- Write
- Read Address
- Read Track
- Write Track
- Force Interrupt

Status

- Busy
- Index
- Track 00
- CRC Error
- Seek Error
- Head Loaded
- Diskette Protected
- Not ready
- Data Request
- Lost Data
- Record Not Found
- Record Type/Write Fault
- Record Type/Write Protect

The Frugal Floppy™

At last, a high performance, low cost Floppy Disk Subsystem is available for OEM or hobbyist microprocessor based systems. The system elements are the same ones used in iCOM's proven FD360 Floppy Disk Systems in use throughout the world.

At last, a high performance, low cost Floppy Disk Subsystem is available for OEM or hobbyist

microprocessor based systems. The system elements are the same ones used in iCOM's proven FD360 Floppy Disk Systems in use throughout the world.

By eliminating expensive cabinetry, power supply, and system assembly labor, iCOM can offer the most cost effective Floppy Disk System available anywhere.

HERE'S WHAT YOU GET

- Controller/formatter Model CF360, completely assembled and tested at iCOM factory. See CF-360 specification sheet (other side) for complete controller details.
- Brand new daisy chainable floppy disk drive
- Controller-to-computer connecting ribbon cable with connector
- Controller-to-disk drive interconnecting ribbon cable with connectors. Includes dual disk connectors ready to add second disk in the future.
- Mating connectors to connect the controller and disk drive to your power supply
- Controller inter-board cables
- Complete logic and schematic diagrams, maintenance manual, and interfacing manual including software command, data and status information
- Full parts and labor warranty for 90 days.

SUMMARY SPECIFICATIONS

- Two independent 128 byte I/O buffers
- IBM compatible 256K bytes/diskette capacity. One drive included. Controller supports up to 4 drives
- Power requirements:
(All $\pm 5\%$, 0.1% regulation)
+ 24V @ 2 amps average per drive
- 12V @ 1 amp
+ 5v @ 6 amps
- Dimensions:
Controller: 2 PCB's 7 x 15 inches each
Disk Drive: 3.45" x 8.58" x 13.28"
Cables: Disk to controller---24"
Controller to CPU---48"

CF 360 FLOPPY DISK CONTROLLER

The iCOM Model CF360 Controller/Formatter is designed for use by OEM's in industrial, commercial, and development applications. It is the same controller used in the iCOM FD360 series Floppy Disk System.

The CF360 can accommodate from one to four floppy disk drives and includes a TTL compatible general purpose interface.

The CF360 offers many features which reduce computer service overhead. For example, the controller is fully IBM 3740 and 3540 compatible with all formatting and deformatting accomplished automatically within the controller. The controller also performs track seek/verify, and CRC (Cyclic Redundance Check) generation and verification automatically.

Independent 128 byte (full-sector) input and output buffers offer the possibility for DMA or programmed I/O operation. The ability to write-protect individual drives is also provided by the controller.

Interface signals to the CPU/MPU are TTL compatible and consist of independent input and output parallel data lines and an 8 bit parallel control port. Upon command, controller status data is presented to the CPU via the input data lines.

DISKETTE FORMAT SPECIFICATIONS

- 2,050,048 bits/diskette
- 256,256 bytes/diskette
- 77 tracks/diskette

- 26 sectors/track
- 128 bytes/sector
- Uses IBM 3740 initialized type media available from many sources including iCOM
- Fully IBM 3740 Format & Media compatible

CONTROLLER SPECIFICATIONS

- Housed on two 7.25 x 15 inch (18.4 x 38.1 cm) PCB's
- Interface connectors on one edge obivate need for card cage or back plane wiring
- Requires +5 VDC $\pm 5\%$ @ 6 amps and -12 VDC $\pm 5\%$ @ 1 amp
- All signals are TTL, Grd True (Pos True optional)
- 16 Output Lines, 8 Input Lines

STATUS FUNCTIONS

- Busy
- Selected Unit (2 Bits)
- CRC Error (data error on Read or Seek)
- Deleted Data Address Mark (found on Read)
- Drive Fail (selected unit not ready, e.g. door open, no diskette, or not up to speed)
- Write Protect (selected unit Write-Protected)
- Done (2 usec pulse)

COMMAND FUNCTIONS

- *SEEK AND VERIFY* (Seeks selected track and verifies

track address from ID field)

- *SEEK TRACK 0* (Seeks Track 0)
- *SECTOR AND UNIT SELECT* (specifies sector and unit number for Read/Write operation)
- *TRACK SELECT* (specifies track to be used by next seek)
- *WRITE* (Writes contents of Write Buffer to selected unit and sector on existing track)
- *READ* (Reads contents of selected sector into Read Buffer)
- *WRITE DELETED DATA ADDRESS MARK* (Same as Write but uses header in Data Field which can later be detected in Read operation)
- *READ CRC* (Same as Read but no data is transferred to the Read Buffer. Used to verify integrity of data previously written)
- *SHIFT WRITE BUFFER* (Loads data into Write Buffer)
- *SHIFT READ BUFFER* (Inputs data from Read Buffer)
- *GATE STATUS* (Gates status or data onto Input Data Lines)

DEBBI™ Disk Extended BASIC By iCOM

DEBBI is a comprehensive BASIC language system designed to be compatible with iCOM's FDOS-IIIR floppy disk operating system.

DEBBI has the easy-to-use algebraic structure and interactive nature of standard BASIC, but includes a number of features making it even more powerful.

- String constants, variables and arrays can be handled, as well as numbers.
- Arrays can have any number of dimensions up to the limit of available memory.
- An integral EDIT command makes program modification and correction fast and easy.
- Lines can be numbered and renumbered automatically, leaving the programmer free to keep track of program logic line numbers.

ARITHMETIC

For arithmetic calculations, DEBBI provides the following features:

- A full complement of arithmetic operators, including integer division (about eight times faster than floating point) and a modulus arithmetic operator. The standard addition, subtraction, multiplication, division and exponentiation operators are provided.
- Logical operators include AND, OR, NOT, IMP (implication), EQV (equivalence) and XOR (Exclusive OR).
- Numeric variables may be of integer, single precision or double precision type. Types may be declared explicitly or implicitly.
- A full range of mathematical functions are intrinsic to the system.

These include:

- ABS—absolute value
- ATN—arc tangent
- COS—cosine
- EXP—exponential function
- FIX—truncates floating point to integer
- INT—largest integer less than the argument
- LOG—natural logarithm
- RND—random number generator

SGN—determines sign of argument

SIN—sine

SQR—square root

TAN—tangent

INPUT/OUTPUT

In addition to the standard INPUT, PRINT and READ statements, DEBBI also provides a PRINT USING statement for formatted output and a LINE INPUT statement for text entry. Byte-oriented transfers are allowed by the INP and OUT statements.

STRINGS

DEBBI's string manipulation functions allow the processing of alphanumeric strings up to 255 characters long. String length is variable and need not be declared explicitly.

- DEBBI allows string variables and multi-dimensional string arrays.
- A concatenation operator adds one string to the right end of another
- Substrings may be taken from the left end, right end or middle of a string.
- Numbers may be converted into their string representations in decimal, octal or hexadecimal notation, and vice-versa.
- Characters can be converted to their binary ASCII code, and vice-versa.

OTHER POWERFUL FEATURES

- A DEFUSR function allows up to ten machine language subroutines to be used with a BASIC program. Starting addresses are generated automatically.
- Famous "PEEK" and "POKE" features read and write data to or from programmer-specified memory locations.

ICOM'S NEW FDOS-IIIR Floppy Disk Operating System for Microcomputers

- Features relocatable assembler for Z80 and 8080 code to give you maximum flexibility and power. Destined to become the new standard of the microcomputer world.

- All console communications in decimal format for ease of program development.

- "BATCH" command allows automatic chain operations.

- Also includes optional operator prompt feature for variable input requirements.

- Fully compatible with programs written under iCOM's FDOS-II. Allows immediate use of any existing iCOM compatible programs.

- Relocatable driver modules allow easy use of iCOM software and hardware in custom or OEM volume applications.

- Handles binary or hex ASCII files with ease for maximum data handling flexibility.
- String oriented text editor makes file or program modification fast and easy.

Although iCOM's new FDOS-IIIIR retains all the sought after features of the famous iCOM FDOS-II package, new power and versatility make FDOS-IIIIR the answer to tomorrow's problems as well as today's.

FDOS-IIIIR provides one of the most powerful and complete development software packages available anywhere. When used with any of iCOM's family of Floppy Disk Systems and compatible plug-in interfaces, FDOS-IIIIR provides an easy to use, reliable, fast, and extremely efficient capability for auxiliary program and data storage. Using the iCOM program development package, time is reduced by a factor of 20 to 100 compared to cassette or teletype. Discover how the iCOM Floppies with FDOS-IIIIR can bring new speed, convenience, and capability to your development tasks.

PROVEN FLOPPY DISK HARDWARE

No matter which member of the iCOM family of Floppy Disks you choose, you are assured of getting proven designs built to the exacting standards of the Pertec Computer Corporation. All iCOM Floppy Disk products give you these important features:

- Direct plug in compatibility with most popular microcomputers.
- Head and pressure pad retraction from media for maximum diskette life.
- IBM compatible data format on full sized diskette.
- Multiple disk drive capability with no modifications. Just plug in additional drives.
- Individual drive write protect capability for security of data.
- Complete hardware track seek and verification reduces computer workload.
- Complete hardware CRC generation and verification.

FDOS—IIIIR: THE COMPLETE PROGRAM DEVELOPMENT PACKAGE

iCOM FDOS-IIIIR is a complete program development system which, along with the microcomputer's monitor, provides high-speed software development tools usually available only on large minicomputer systems. With iCOM FDOS-IIIIR, you can virtually eliminate the need for paper tape or cassette storage and handling. Program storage and back-up is now on low-cost, reusable, compact, and reliable diskettes which are readily available from a number of sources, including iCOM.

The single command operations of FDOS-IIIIR gives you disk-to-disk program editing and assembling; disk-to-memory program loading; named files; disk-to-punch device transfer, reader-to-disk transfer; disk-to-disk transfer, and more.

Using FDOS-IIIIR you can achieve at least a 50-fold increase in program development throughput. The

time required for a typical edit/assembly sequence is reduced to minutes, as opposed to almost 3 hours required when using a teletype, or 45 minutes when using a high speed paper tape reader or cassette unit.

• INCLUDES RESIDENT FDOS, PLUS RELOCATABLE ASSEMBLER AND EDITOR!

The resident FDOS-IIIIR is conveniently contained in a 1K PROM located on the plug-in interface card. FDOS-IIIIR also contains its own powerful disk-resident assembler and editor. The microcomputer's monitor remains intact, thus retaining all existing non-FDOS operations. FDOS-IIIIR is available for any iCOM Floppy Disk System operating on 8080 or Z80 and can utilize all available disk storage capacity.

• VARIABLE-LENGTH NAMED FILES

The storage area on each diskette is available for any number of files of any length from a single sector up to an entire diskette. The files may contain program source data, program object data, or user generated data.

Files are specified by a 1-5 character filename, and any number of files may be merged to create a new file. Any file may be renamed, or files may be deleted (FDOS repacks the diskettes automatically to make the deleted filespace available). Also, files may be tagged with attributes (i.e. a file may be declared permanent, not allowing it to be inadvertently deleted).

FDOS-II'S POWERFUL COMMAND REPERTOIRE

When you put an iCOM Floppy with FDOS-IIIIR on your microcomputer, you also get a comprehensive Operator's Guide with detailed description, examples and explanations of how to use FDOS-IIIIR to maximum advantage. Below is a brief summary of the commands you have available with FDOS-IIIIR.

COPY

Copies the contents of the entire diskette in drive unit "o" onto the diskette in drive unit "1".

COPY, file

Copies the contents of only the specified file.

ALLOC,size,filename

Creates the designated filename in the directory and allocates disk space equal to size.

BATCH

Allows you to specify in the BATCH file a series of operations to be performed in sequence, with little or no operator intervention. You can also insert optional operator prompts between any operations when operator response or attention is required.

DELET:u,filename 1,filename 2,.....filename n

Deletes the designated files from the diskette in drive unit u.

PACK,u

Automatically repacks the contents of the diskette in drive unit u, making the disk space available for additional files.

DELPK

Combines DELET and PACK functions in a single command.

EDIT,input filename,output filename

Enables editing of the input file's contents. Edited data is stored into the output file. String oriented format makes program or file modification fast and easy.

ASMB,source filename,destination filename,p

New! Z80 or 8080 code. Assembles the contents of the source file and directs the object output to the destination file. p is the pass number which determines

whether you want the assembly to produce a listing only, object only, or both. New relocatable feature lets you assemble programs for execution wherever you desire in memory. If you have an 8080 now but are thinking about using the Z80 in the future, FDOS-III gives you full capability now and for the future.

VIEW,filename,device,#of lines per frame

Allows you to view or print a file. You can specify the number of lines to be viewed at one time, or you can output the entire file. Time saving multiple frame scan allows you to scroll rapidly forward or backwards through any file.

LIST,n,device,mode

Lists the contents of the directory of the diskette in drive n on the console or on the printer. Optional mode allows listing 11 directory entries at one time to facilitate viewing lengthy libraries.

LIBO

Provides management of relocatable code files within specific FDOS-III files.

RDBFL,filename

Displays contents of binary files on console or list device

DUMP,filename

Dumps the contents of the file to the punch output storage device, or communication link device. File structure can be either hex or binary format as you choose. Formats can be mixed on a diskette too.

LOAD,destination filename

Loads the contents of the reader device into the specified file on diskette. Any file can be hex or binary as you choose.

MERGE,new filename,filename 1,filename 2,.....,filename n

a new file which is a concatenation of filenames 1-n, in that order.

PRINT,filename,device

Prints the contents of the file on the list output device. If you wish to print only part of a file you can specify the number of lines to be printed on console or printer.

RENAM,old filename,new filename

Renames the old file with the new filename.

FILENAME,(IMPLIED RUNGO)

Loads the contents of the file into RAM and begins execution.

RUN,filename

Loads the contents of the file into RAM for examination or modification.

LINK,command file,output file,pass

Links relocatable object modules and stores object code in absolute format in output file. Optional pass allows module alignment on page boundaries for ease of debugging.

XGEN,filename

Enables system generation of other iCOM FDOS versions as might become available in the future.

CHGAT,filename,new attributes

Changes the present attributes of the designated file to those specified in the new attributes field. Can be used to declare a file "permanent" or as a file classification character.

HOME,u

Positions the disk head on drive unit "u" to track 0.

INIT,u

Initializes the file directory on the diskette in drive unit "u". Clears any existing user files on that diskette.

EXIT

Returns to the microcomputer system monitor.

iCOM PRICES

Catalog Order No.	Description	Unit Price
FD3712-XX	Dual Desk Top Floppy System..... with Controller and Power Supply, complete.	\$2,650.00
FD3711-XX	Single Desk Top Floppy System..... with Controller and Power Supply, complete.	\$2,350.00
Options for Model FD3712-XX	Specify at time of order—Includes Hardware Interface, Software on Diskette and Documentation	
-57	Altair FDOS-II Software	\$ 300.00
-58	IMSAI FDOS-II Software	\$ 300.00
-59	POLY 88 FDOS-II Software	\$ 300.00
-60	SOL-20 (Solos) FDOS-III Software	\$ 350.00
	Microfloppy	
FD2411-XX	Single Drive Microfloppy, Assembled,..... Tested, Power Supply with Interface/ Controller, FDOS-II and DEBBI* Software Documentation included.	\$1,095.00
FD2402	Second Microfloppy Drive, Assembled	\$ 649.00
	Tested, Cabinet, Power Supply and Daisy Chain Cable.	
FD2403	Third Microfloppy Drive	\$ 649.00
	with 3 Drive Cable	
At the time of Order select	Interface/Controller Model—XX	
-46	For SOL-20 (Solos) FDOS-III and DEBBI* Software	
-47	For Altair FDOS-II and DEBBI Software	

DIGITAL SYSTEMS

FLOPPY DISK SYSTEM FDS-1

DIGITAL SYSTEMS now has available a high quality Floppy Disk System. The system is completely assembled and tested and features Shugart Associates drives and Digital Systems FDC-1 controller. Disk formatting is IBM compatible and diskette initialization capability is provided. The powerful CP/M Disk Operating System, written by the originator of Intel's PL/M compiler, has been operational on this hardware for over two years and is available for only \$70. An interface is available to the Altair/IMSAI bus. All systems are completely assembled and tested and carry a 90-day warranty.

Features

HARDWARE

- The Controller uses the IBM format, implemented with a TTL microcontroller.
- Hardware implements 2 byte CRC error check and generate.
- Once initialized, all data transfers for sector READ or WRITE are handled by the controller via a simple DMA interface allowing concurrent processor execution.
- Simple COMMAND and STATUS registers are available via programmed I/O.
- All interface signals are TTL compatible.
- Hardware bootstrap is available without processor intervention.
- Systems are thoroughly tested and burned in before shipment.

- The hardware design is field proven for over two years.
- Hardware and Software is Z80 compatible.

SOFTWARE

- Software driver flowcharts and 8080 assembly language routines for READ, WRITE, and SEEK are provided.
- A complete 8080 operating system is available.
- The CP/M Operating System was developed on our hardware, and systems have been operating in the field for over two years.
- CP/M is a complete software package consisting of:
BDOS—Basic Disk Operating System
CCP—Console Command Processor
PIP—Peripheral Interchange Program
ED—CP/M Text Editor
ASM—CP/M Assembler
DDT—Dynamic Debugging Tool with Breakpoint, Trace, and built-in assembler and disassembler.
- A user library of CP/M compatible software with high-level language processors, including extended disk BASIC.
- Custom I/O devices are easily patched into CP/M.

COMPLETE SYSTEM—1 or 2 Assembled

This package is a completely assembled and tested unit with a cabinet, power supply, FDC-1 controller, S-Unit with a cabinet, power supply, FDC-1 controller, S-100 interface, disk drives, and all connecting cables.

Catalog Order No. FDS-1-1

Single Drive System \$1,845.00

Catalog Order No. FDS-1-2

Dual Drive System \$2,545.00

FDC-1 CONTROLLER BOARD Assembled

The FDC-1 is an IBM compatible controller for the Shugart floppy disk drives. It comes with connecting cables to the drive.

Catalog Order No. FDC-1

Controller Card \$ 650.00

CP-M SOFTWARE

Six system manuals and object code on verified diskette are available for

Catalog Order No. CP-M

Manuals and Diskette \$ 70.00

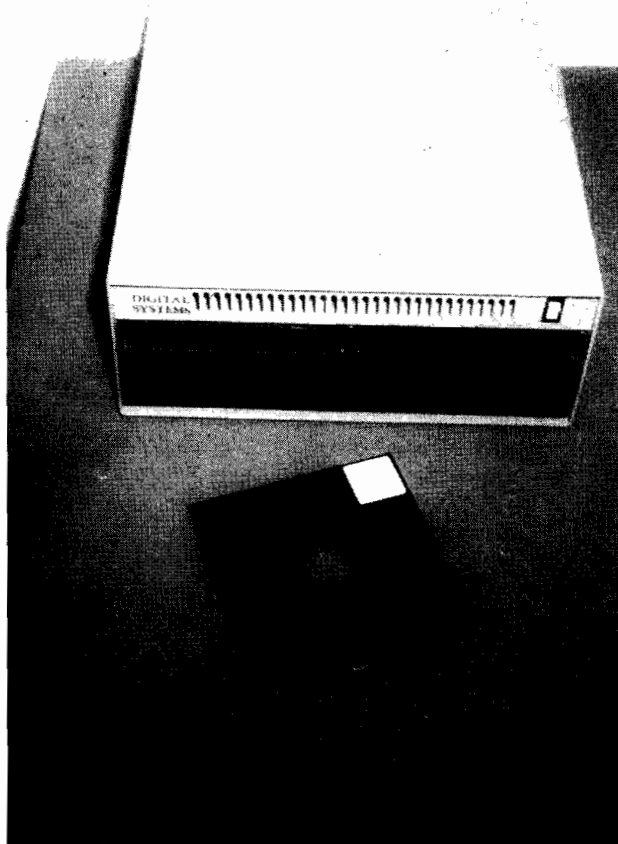

Catalog Order No.	Description	Unit Price
-48	For IMSAI FDOS-II and DEBBI* Software	
-49	For POLY 88 FDOS-II and DEBBI* Software	
Frugal Floppy—Section		
FF36-1	Single Drive Frugal Floppy	\$1,195.00
	Includes Controller/Formatter	
FF36-2	Dual Drive Frugal Floppy	\$1,895.00
	Includes Controller/Formatter	
360-57	Altair Interface, FDOS-II	\$ 300.00
	Software Diskette and Manual	
360-58	IMSAI Interface, FDOS-II	\$ 300.00
	Software Diskette and Manual	
360-59	POLY 88 Interface, FDOS-II	\$ 300.00
	Software Diskette and Manual	
360-60	SOL-20 (Solos) Interface, FDOS-IIIR	\$ 350.00
	Software Diskette and Manual	
FD400-20	Upgrade Kit converting Single Drive to	\$ 700.00
	Dual Drive System	
S171H	Frugal Floppy Power Supply	\$ 250.00
Software Options—Section		
FDOS-II	Dos Software with relocatable Assembler/Linker for Z80 and 8080 Code	
	-57 Altair	\$ 50.00
	-58 IMSAI	\$ 50.00
	-59 POLY 88	\$ 50.00
	**47 Altair (Microfloppy)	\$ 50.00
	**48 IMSAI (Microfloppy)	\$ 50.00
	**49 POLY 88 (Microfloppy)	\$ 50.00
	**46 SOL-20 (Solos) (Microfloppy)	\$ 50.00

Catalog Order No.	Description	Unit Price
DEBBI™	Disk Extended Basic by iCOM	
	-57 Altair	\$ 75.00
	-58 IMSAI	\$ 75.00
	-59 POLY 88	\$ 75.00
	-60 SOL-20 (Solos)	\$ 75.00
	-47 Altair (Microfloppy)	\$ 75.00
	-48 IMSAI (Microfloppy)	\$ 75.00
	-49 POLY 88 (Microfloppy)	\$ 75.00
	-46 SOL-20 (Solos) (Microfloppy)	\$ 75.00



CENTRONICS

700 series overview

In response to the business community's need for a truly user-oriented family of low- to high-speed, attractively priced serial printers...Centronics now offers the simply better 700 Series.

The 700 Series is an applications-oriented family, well suited to a variety of business environments. The family's performance range encompasses the Serial Dot Matrix market — from 13 to 370 lines-per-minute, and offers:

- **Broad Range and Modular Flexibility** — provide price/performance **TODAY**.
- **Upward Compatibility and Optional Features** — provide expansion and flexibility for the **FUTURE**.
- **High Reliability and Spare Parts Commonality** — provide low cost-of-ownership **ALWAYS**.

MODEL 700

This printer presents an ideal solution for those users that require basic low throughput, hard copy output. The 700 is a 60 character-per-second serial printer, which offers up to 132 column Dot Matrix printing. Effective throughput is from 13 to 90 lines-per-minute.

The 700's performance characteristics are well suited for CRT output, data logging, stand alone business systems, or applications where selective off-line printing is required.

MODEL 701

The 701 has similar characteristics to that of the 700. Its faster speed attracts those having higher throughput requirements. The 701's 60 character-per-second printing is enhanced by the bidirectional, logic seeking movement of the print head. Data can be printed from 26 to 120 lines-per-minute in formats up to 132 columns.

The 701's performance characteristics match those requirements needed with small business systems, reservation systems, banking, credit and other applications.

MODEL 703

The model 703 represents the top of the 700 Series line. 180 character-per-second, bidirectional, logic seeking, dot matrix printing puts the 703 in a class approaching that of line printers. It provides high throughput rates from 75 to 370 lines-per-minute. Formatting freedom is enabled by the 132 column print image and optional features such as operator selectable 6/8 inch vertical spacing and either a 2, 8 or 12 channel electronic vertical format unit.

The 703 is offered as a solution to business system environments having high speed, high throughput requirements and as an upgrade for 700/701 users.

MODEL 780

The 780 is Centronics' answer to users with limited space availability. This stylish low-profile machine (19.4" wide, 18" deep and 8" high) is ideal for counter top use in banks, airline terminals, or retail environments. Although it has an 80-column print image, 132 column forms can be produced using the condensed printing feature. Condensed printing on an eight-inch form results in substantial paper savings.

The 780's 60 character-per-second print speed results in up to 90 lines-per-minute output, which is ideal for invoice, airline manifests, stock reports, data logging applications or CRT output.

MODEL 781

The 781 has the same attractive features as that of 780, with one important exception — bidirectional, logic seeking movement of the print head enables throughput of up to 120 lines-per-minute. This advantage is essential to high throughput environments and provides an upgrade for 780 users.

For performance comparison and specific feature availability refer to the 700 Series Features List.

MODEL 761

The 700 Series would not be complete without a versatile teleprinter designed to sustain 300 baud transmission rates. The 761 has the same modular flexibility as other 700 models and is offered in a keyboard send/receive (KSR) or a read only (RO) configuration. Both models print bidirectionally and employ state-of-the-art-microprocessor technology.

The 761 KSR and 761 RO offer an integrated serial asynchronous interface for direct connect or remote operations. The serial interface conforms to EIA RS-232/CCITT V.24 or 20/60 milliamp current loop.

The 761 RO/KSR are designed to be used as output/input computer consoles, remote terminals in message switching networks, inquiry response, data entry/logging systems, and on-line time share systems.

**CENTRONICS PRINTERS
SOLD BY QUOTATION ONLY**

FLEXIBILITY THROUGH MODULARIZATION

Each member of the 700 Series is configured to meet the needs of different segments of the Serial Dot Matrix printer market. Product differentiation is accomplished using one of the print modules and adding various modules matching the application areas desired. Each printer within the family is composed of three or four distinct modules.



PRINT MODULES

Two highly reliable carriage drive systems are used with the 700 Series print modules:

- Synchronous motor band drive—700, 701, 761, 780, and 781
- Stepping motor drive—703

Working in conjunction with the drive system is a wire dot matrix print head which was pioneered and patented by Centronics. Depending on the model, this print head can be configured to produce 5x7, 7x7, 9x7, 7x9, and 9x9 dot matrix pattern of crisp, clean print. A 64 ASCII character set is standard on all models; however, over 60 optional character sets can be specified.

Six line-per-inch vertical spacing is standard on all 700 members and paper movement is up to 15 inches-per-second on the 703. To highlight important data, a selectable or full line elongation feature comes standard on all models. All members use an economical ribbon cartridge stuffing box design for easy, clean ribbon replacement. The continuous loop ribbon is ten yards long and has a normal life of over two million characters.

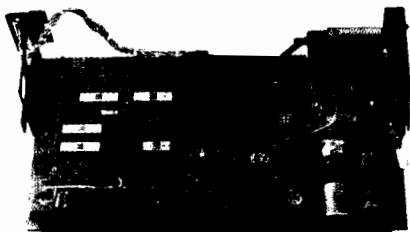

ELECTRONICS MODULES

Printer control is maintained by the electronics modules which contains the input power transformer, DC power supply and logic card. Electronics for models 700, 701, 780, and 781, utilize LSI technology to minimize component parts in addition to providing easy maintainability. Control for model 703 and 761 is maintained by state-of-the-art micro-processor electronics.



PAPER HANDLING MODULES

One of three different paper handling methods can be incorporated on 700 Series printers:

- **Pinch Roll**—recommended for those users requiring an original and one copy output. Paper rolls up to 6.7 inches in diameter are fed through the rear paper feed. Maximum paper width is 9.8 inches affording an 8-inch print width.
- **Tractor Feed Module**—recommended for those users with up to five-part form requirements. Paper can be fed through either the rear or bottom feed. Depending on model type, forms up to 17.3 inches wide with a print image up to 13.2 inches can be used.
- **Pin Feed Platen Module**—recommended to those users having demand printing requirements. (up to five parts). The pin feed platen permits the operator to tear the paper close to the last printed line. Depending on model, forms up to 14.8 inches wide with a print line up to 13.2 inches can be used.



KEYBOARD MODULE

The keyboard module is used with the 761 KSR. The keyboard contains 61 sculptured keys arranged in a standard typewriter layout. The keys are capacitively coupled using solid state electronics and are rated at 100 million operations. Optionally, a 10-key numeric pad is offered for those high-numeric use environments. A six-key printer control panel is located at the left of the keyboard.

To facilitate operator/keyboard interaction both physical (positive tactile feel) and audible (key clicker) feedback systems have been incorporated.

700 SERIES FEATURES

MODEL	700	701	703	780	781	761
FEATURE						
Print Speed	60CPS	60CPS	180CPS	60CPS	60CPS	300 BAUD
Lines-Per-Minute						
20 char. per line	90	120	370	90	120	NA
80 char. per line	21	43	120	21	43	NA
132 char. per line	13	26	75	NA	NA	NA
Unidirectional Printing	STD	NA	NA	STD	NA	NA
Bidirectional Printing	NA	STD	STD	NA	STD	STD
LSI Electronics	STD	STD	NA	STD	STD	NA
Microprocessor Electronics	NA	NA	STD	NA	NA	STD
5x7 Dot Matrix	STD	STD	OPT	STD	STD	OPT
7x7 Dot Matrix	NA	NA	STD	NA	NA	STD
9x7 Dot Matrix	OPT	OPT	OPT	OPT	OPT	OPT
7x9/9x9 Dot Matrix	NA	NA	OPT	NA	NA	OPT
Paper Slew	5.5 IPS	5.5 IPS	15 IPS	5.5 IPS	5.5 IPS	5.5 IPS
Prints Original Plus—Copies Pinch Roll	1	1	1	1	1	1
Tractor/Pin Feed Platen	4	4	5	4	4	4
Ribbon Cartridge	STD	STD	STD	STD	STD	STD
Vertical Spacing 6LPI	STD	STD	STD	STD	STD	STD
Character Set						
64 Standard ASCII	STD	STD	STD	STD	STD	STD
Character Sets 64, 96, 128	OPT	OPT	OPT	OPT	OPT	OPT
Selectable Vertical Spacing 6/8	NA	NA	OPT	NA	NA	NA
Paper Handling						
Pinch Roll (Rear Feed Only)	STD	STD	NA	STD	STD	STD
Max. Paper Width (in.)	9.8	9.8	NA	9.8	9.8	9.8
Max. Print Width (in.)	8.0	8.0	NA	8.0	8.0	8.0
Tractor Feed (Rear or Bottom Feed)	OPT	OPT	STD	OPT	OPT	OPT
Max. Paper Width (in.)	17.3	17.3	17.3	12.1	12.1	17.3
Max. Print Width (in.)	13.2	13.2	13.2	8.0	8.0	13.2
Pin Feed Platen	OPT	OPT	OPT	OPT	OPT	OPT
Max. Paper Width (in.)	14.8	14.8	14.8	9.5	9.5	14.8
Max. Print Width (in.)	13.2	13.2	13.2	8.0	8.0	13.2
Interface; Parallel—CDCC	STD	STD	STD	STD	STD	NA
Two Channel Mechanical VFU	OPT	OPT	NA	OPT	OPT	OPT
Electronic VFU 2, 8, 12 Channel	NA	NA	OPT	NA	NA	NA
Electronic Top of Form	NA	NA	STD	NA	NA	NA
Automatic Motor Control	STD	STD	STD	STD	STD	STD
Condensed Print— 12, 15, 16.5 cpi Fixed	OPT	OPT	OPT	OPT	OPT	NA
Condensed Print— 10, 12, 15, 16.5 Switchable (any two)	OPT	NA	NA	OPT	NA	NA
Selectable Single Character or Full Line Elongation	STD	STD	STD	STD	STD	STD
Column Scale/Tear Bar	STD	STD	STD	STD	STD	STD
Self Test	NA	NA	STD	NA	NA	STD
Paper Empty Indicator	STD	STD	STD	STD	STD	STD
Audio Alarm	OPT	OPT	OPT	OPT	OPT	OPT
Single Line Feed Switch	OPT	OPT	STD	OPT	OPT	OPT
Forms Override Switch	OPT	OPT	STD	OPT	OPT	OPT
Single/Double Line Feed Switch	OPT	OPT	OPT	OPT	OPT	OPT
Elapsed Print Time Indicator	OPT	OPT	OPT	OPT	OPT	OPT
Auto LF on CR	OPT (N/C)	OPT (N/C)	OPT (N/C)	OPT (N/C)	OPT (N/C)	OPT (N/C)
Printer Stand	OPT	OPT	OPT	OPT	OPT	OPT

Specifications subject to change without notice.

SOROC IQ 120 TERMINAL

- Cursor Control Keys Standard
- Numeric Key Pad Standard
- Line and Page Erase Standard
- Addressable Cursor Standard
- Switch Selectable Transmission from 75 to 19,200 bps Standard
- Communication Mode: HDX/FDX/Block
- Interfaces: Printer Interface/RS232 Extension
- RS232C Interface
- Non-Glare Read Out Screen
- Protect Mode Standard
- Tab Standard

The SOROC IQ 120 is the result of an industry-wide demand for a capable remote video display terminal which provides a multiple of features at a low affordable price. THE IQ120 terminal is a simple self contained operator/computer unit. The IQ120 offers such features as: switch selectable transmissions rates from 75 to 19,200 bps, cursor control, RS232C interface, addressable cursor, erase functions and protect mode. Expansion options presently available are: block mode hard copy capability with printer interface, lower case, RS232C extension and 1920 character screen memory. The IQ 120 terminal incorporates a 12-inch CRT formatted to display 12 (or optional 24) lines with 80 characters per line.

SPECIFICATIONS

Industry Compatability
Lear Siegler Compatable Code Structure

DISPLAY FORMAT
12 lines x 80 characters

DISPLAY SIZE
6.5" high x 8.4" wide

CRT SIZE
12" measured diagonally

CHARACTER SIZE
Approximately 0.2" high x 0.1" wide

CHARACTER TYPE
5 x 7 dot matrix—Two dot spacing between characters, white on black, two scan spacing between adjacent lines.

CHARACTER SET
64 ASCII displayable

CHARACTER GENERATION
MOS ROM

REFRESH RATE
60 Hz

REFRESH MEMORY
MOS RAM

CURSOR
Non-destructive block

CURSOR CONTROL
Left, Right, Up, Down, Home, Carriage

Return, Line Feed, Format Tab
COMMUNICATIONS INTERFACE
Serial RS232C

TRANSMISSION RATE
Switch selectable 75 to 19,200 bps

COMMUNICATION MODE
Full duplex, Half duplex, 10 or 11 bit word, asynchronous

PARITY
Odd, Even, Mark or Space strap

selectable
CONVERSATION MODE
Character by character transmission

PROTECT MODE
Protected data displayed in reduced intensity

ADDRESSABLE CURSOR
Directly positions the cursor by line and column

SCROLL
The unit is in scroll mode when the display is unprotected

ERASE FUNCTIONS
Erase from cursor to end of line or field
Erase from cursor to end of memory
Clear screen
Erase unprotected fields in protect mode

BELL
Audible alarm when control G is received

KEYBOARD
73 keys featuring auto repeat, alpha lock, 11-key numeric pad with decimal, and additional functional keys for convenient operation

INPUT VOLTAGE
115VAC 10% 60 Hz

TERMINAL WEIGHT
45 lb. approximately

TERMINAL SIZE
18" W x 13" H x 20.5" D

OPERATOR CONTROLS
Keyboard
Rear Panel—power on/off, Full duplex/Half duplex
Contrast, I/O baud rate, Brightness
PC Board—Parity Selection, 10/11

bit word. printer baud rate
SIGNAL CHARACTERISTICS

Transmit
Mark= -10 Volts nominal
Space= +10 Volts nominal
Receive
Mark= -3 Volts to -25 Volts
Space= =3 Volts to =25 Volts

TRANSMISSION CODE
Start Bit=1 bit
Data Bit=7 bits ASCII
Parity Bit=1 or 2 bits

ENVIRONMENTAL SPECIFICATIONS
Altitude: Sea level to 10,000 ft. (operational)
Temperature: +5°C to +40°C
Humidity: 5% to 90% non-condensing
Vibration: Shock (in shipping container)
Vibration (non-operational) =10 Hz to 55Hz0.01" peak to peak

STRAPPING OPTIONS
•Printer Baud Rate
•Parity Odd/Even
•10- or 11-bit Word
•Mark/Space Parity
STANDARD OPTIONS
•95 character ASCII set displayable (Upper/Lower Case)
•24 lines x 80 characters
•Line/Page Block Send
•Screen Print
•RS232 Extension
Catalog Order No. IQ 120
SOROC Terminal Assembled
\$995.00

SANYO

9 inch (diag.) video monitor VM-4092 \$170.00

Description

VM-4092 38 square inches of sharp, clear video and professional features make this industrially designed video monitor an excellent choice for the most demanding CCTV and VTR applications. All solid state circuitry and rugged construction assures complete reliability in a wide range of environments.

A high impedance bridging input-with switchable 75 ohm termination permits the Model VM-4092 to be used singly, or to be connected in a loop-through configuration with other video monitors. Fast acting horizontal AFC circuits assure full compatibility with all helical scan video tape recorders.

Brightness, contrast, vertical hold and horizontal hold controls are located on the front panel for operator convenience.

Housed in an attractive steel cabinet, the Model VM-4092 may be operated on a desk top or mounted in a standard 19 inch communications rack in pairs.

Catalog Order No. VM-4092 Price is \$ 170.00

VM-4092 SPECIFICATIONS

Viewing Area

38 square inches; 9 inch diagonal

Picture Tube

24OdB4; 90° deflection, aluminized

Scanning System

EIA Standard (525 lines; 30 frames, 60 fields/sec.)

Synchronization

Internally derived

Horizontal Resolution

600 lines

Video Input/Output Level

1.0 volt p-p composite composite video, sync negative

Video Input Impedance

High Impedance bridging; switchable 75 ohm termination

Horizontal Time Constant

Corrected for use with helical scan VTR's

Semiconductor Complement

16 silicon transistors; 10 silicon diodes

Power Requirements

117 V.A.C.; 60 Hz; 25 watts

Cabinet

Painted steel

Dimensions

8-³/₈"(w); 9-3/16"(h); 9-³/₄"(d)

Weight

13 lbs. 12 oz.

Connectors

Video; Type M

Optional Accessories

RMK-4092 Rack Mounting Kit

KOYO

solid state video monitors VM-9, VM-17S

MODEL	MV - 9	MV - 17S
PICTURE TUBE	9" (230ADB4) 90° Deflection	17" (440MB4) 114° Deflection
SEMICONDUCTORS	14 Transistors, 15 Diodes	16 Transistors, 16 Diodes
INPUT IMPEDANCE	75Ω or High impedance	
INPUT LEVEL	1.4 V _{p-p}	1.4 V _{p-p}
SCANNING FREQUENCY	Horizontal ; 15.75 KHz (* 15.62 KHz) Vertical ; 60 Hz (* 50 Hz)	
RESOLUTION (CENTER)	Horizontal ; 600 lines Vertical ; 300 lines	Horizontal ; 750 lines Vertical ; 300 lines
FREQUENCY RESPONSE	6 MHz	7 MHz
AMBIENT TEMPERATURE	14° F to 113° F (-10°C to 45°C)	
POWER CONSUMPTION	26 watts	65 watts
POWER SOURCE	AC 120 V ± 10%, 60 Hz (*AC 220 V ± 10%, 50 Hz)	
FRONT PANEL CONTROL	BRIGHTNESS, CONTRAST VERTICAL HOLD HORIZONTAL HOLD POWER ON/OFF (with pilot light)	BRIGHTNESS, CONTRAST VERTICAL HOLD HORIZONTAL HOLD POWER ON/OFF (with pilot light)
REAR PANEL CONTROL	75Ω termination switch for video input	
REAR PANEL CONNECTOR	UHF connectors for video input and looping	
DIMENSIONS	8 ³⁷ / ₆₄ " (W) x 9 ³ / ₃₂ " (H) x 8 ⁵⁵ / ₆₄ " (D) (218mm (W) x 231 mm (H) x 225 mm (D))	16 1/4" (W) x 15 5/8" (H) x 12 1/4" (D) (410 mm (W) x 395 mm (H) x 310 mm (D))
WEIGHT	13.2 lbs. (6 kg)	35.2 lbs. (16 Kg)

Catalog Order No. VM-9
9 inch Video Monitor \$166.00

Catalog Order No. VM-17S
17 Inch Video Monitor \$279.00

GEORGE RISK INDUSTRIES , INC.

Model 753 ASCII Keyboard , especially designed for Hobby-OEM Microprocessor users.

Check these professional features:

- 53 Keys, popular ASR-33 format!
- Rugged G-10 P.C. Board!
- Tri-mode MOS encoding!
- Two-Key Rollover!
- MOS/DTL/TTL Compatible outputs!
- Upper Case lockout!
- Data and Strobe inversion option!
- Low contact bounce!
- Selectable Parity!
- Custom Keycaps!
- Three User Definable Keys!
- MORE!

The Model 753 uses only top quality, new components and is furnished with complete documentation and a 90 day limited warranty. The combination of our proven KBM series keyswitches and dependable MOS encoding provides maximum flexibility at minimum cost and complexity. A unique interface arrangement allows user selection of parity, data and strobe sense, upper-case operation, and allows three user-definable keys to be defined as unique keycodes or functions. And it is a natural for microprocessor systems, drawing less than a watt from existing power supplies. The Model 753 comes either fully assembled and tested or in kit form. Rugged construction allows easy mounting, yet assembly time is less than two hours. Both models are provided with full data, and checkout procedures.

Catalog Order No. 753K Keyboard Kit	\$59.95
Catalog Order No. 753A Keyboard Assembled	\$71.25
Catalog Order No. 701 Plastic Enclosure for 753 Keyboard	\$14.95

End your monitoring problems with a

"PIXE-VERTER"

A transistorized modulated oscillator which instantly converts a TV receiver into a top-notch video monitor. Absolutely no wiring modifications required on the TV receiver! Ideally suited for "video only" type cameras , VTR's , computers , games , etc.

FEATURES INCLUDE:

- Operates on any blank channel from 2 to 6.

TV cameras, VTR's, computers, video games, etc. Accepts digital or analog video from .25 to 5V. Wide bandpass allows color & 4.5 Mhz optional sound subcarrier operation.

- No direct camera-to-receiver connection required on AC/DC sets thus reducing possibility of shock hazard.
 - Miniature size (approx. 1.25" x 2.1") allows it to be mounted inside most cameras and VTR's or on back of TV receiver near antenna terminals.
 - Requires less than 3 ma at 6 volts.
 - Printed circuit construction (including oscillator coil) permits quick and easy assembly. Total time averages about 30 minutes.
 - Excellent frequency stability. Precise channel adjustment trimmer.
- able input gain control adjusts for all types of analog and digital signals.

Catalog Order No. PXV-2A
Pixe-Verte Kit \$8.50

A new TV video-to-RF modulator module!

"PIXE-PLEXER"

A special integrated circuit type modulator-RF oscillator module for multiplexing and interfacing color and luminance video signals plus audio from computers , TV cameras , VTR's games , etc , for display on any regular TV set via the antenna terminals.

- 3.5 Mhz color subcarrier oscillator.
- 4.5 Mhz audio subcarrier complete with varactor diode modulator for FM sound insertion.
- Operates on any blank channel from 2 to 6.
- May be operated as simple monochrome character display or deluxe multiplexer-modulator for color difference (R-Y and B-Y) inputs plus audiosubcarrier operation.
- Accepts analog or digital signals.
- Single IC chip construction
- Compact. Printed circuit board size: 1.5" x 3"
- Printed circuit RF coil. Very stable.
- Power requirements: 15V single supply or optional split supply (-12V and +5V). Max. current: 50 ma.
- Complete with assembly instructions plus engineering data sheet on IC for special applications designing.
- P.C. board includes special 'proto-type' section for addition of custom stages and/or circuits.

Catalog Order No. PXP-4500
Pixe-Plexer Kit \$24.50

SUPERSCOPE C-104 CASSETTE RECORDER

FEATURES

Specifications:

Power Requirements:

AC 120 Volts Ac, 6 Watts 50/60 Hz

DC 6 Volts

Battery size and quantity: 4

Size "C" batteries

Battery life: 6 hrs. continuous

Type of Level Indication:

Record Level Battery Strength Meter

Power Output:

1.4 Watts Max. @ 1 kHz

Head Configuration:

1 half track erase

1 half track record/playback

Wow and Flutter:

NAB 0.25% RMS @ 1.7/8 ips

Number and Type of Motor:

1 DC Servo—Vari-Speed+20%

Number of Semi-conductors:

10 Transistors

1 Field Effect Transistors (FET)

6 Diodes

Outputs:

1 Extension speakers: (one)

Plug type: Mini

Impedance: 8 Ohms

Unit Dimensions: 6"W x 2½"H x 11"D

unit weight; 3 lbs., 0 ozs.

Tape Speed:

1-7/8

Reel Size:

Cassette

Recording System:

Half-track Mono

Inputs:

1 Auxiliary: (one)

Plug type: Mini

Impedance: 100 K Ohms

Input Sensitivity: 100 mV

Speaker Complement:

Built-in speaker, 3%

Bias Frequency:

65 kHz

Rewind and Fast Forward Time:

100 seconds/C-60

Frequency Response:

Standard Tape:

60 Hz to 10kHz @ 1-7/8 ips

Signal-to-noise Ratio:

Low Noise Tape: 48dB

1 Microphone: (one)

Plug type: mini

Impedance: Low

Input sensitivity: -72 mV

Catalog Order No. SC-104

Tape Drive.....\$119.00

100 EDGE CONNECTORS

for IMSAI , Cromemco , SOL , Polymorphic , Vector Graphics

Design Features

Bifurcated bellows contact

Choice of mounting styles (thru-hole or tapped insert)

Wire-Wrap and dip solder terminations

Extra-large chamfer board entry

Replaceable contacts

Molded contact identification

In between contact polarizing

Insulator stand-off for solder flux flushing

Increased contact wiping length on PC board

PC board

Specifications

Contact Resistance:

30 Mv (max.) @ rated current

Rated Current:

3 amps. Insulation Resistance:

5000 megohms, minimum

Operating Voltage:

600 VDC @ sea level

Operating Temperature:

-55°C to +150°C

Materials:

Insulator:

Phenolic, color black

Alternate material:

Diallyl Phthalate, color green

Contacts:

Phosphor bronze per QQ-B-750

Gold plated per MIL-G-45204,

Type II.

Polarizing Key:

Glass-filled nylon type 6/6

Catalog Order No. PEC-100

100 Pin Edge Connector with card

guide

Quantity 1-9 \$5.50 ea.

Quantity 10-up \$5.00 ea.

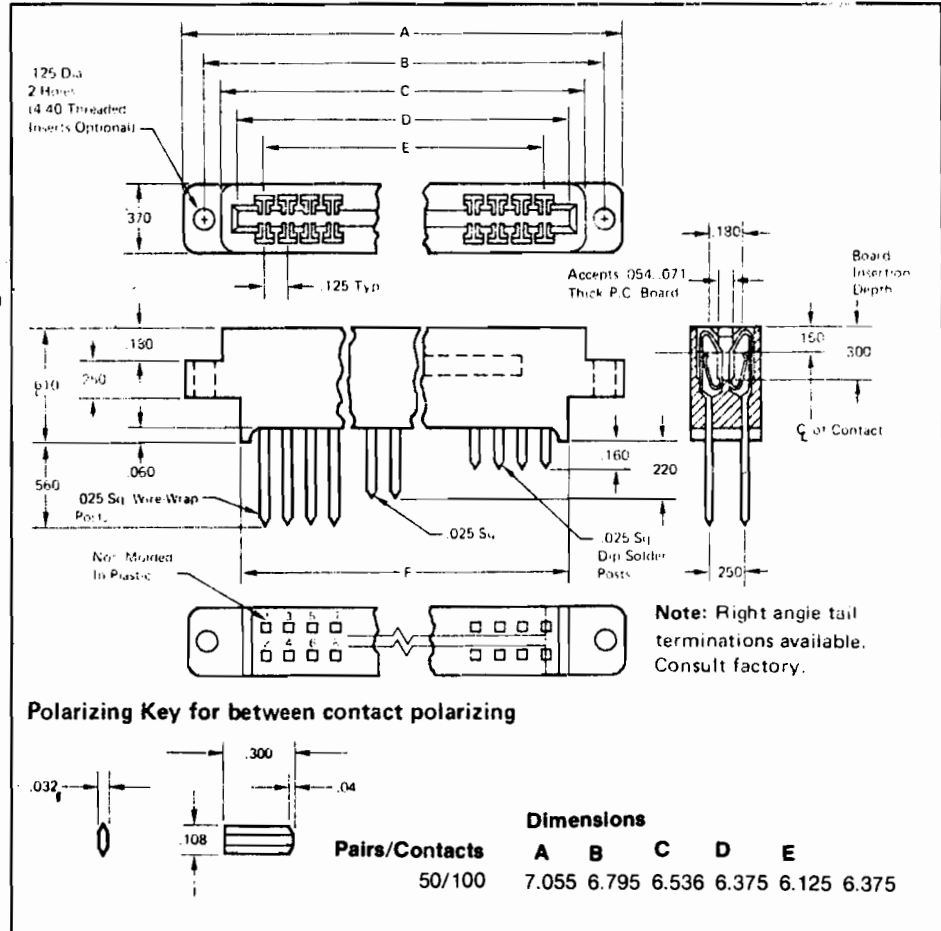

Contact spacing: .125 centers Terminals: Wire-Wrap .025" sq. X .62"; Dip solder .025" sq. X .160" or .220" Pairs/Contacts: 15/30 thru 50/100 For PC Boards ; 1/16 thick

IC SOCKETS

DESIGN FEATURES:

Double-beam contact construction for increased reliability

Gas-tight seal on IC leads at contact area

Closed entry type insulator restricts over-stressing of contact beam

anti-wicking protection

Mounting dimensions per MIL-S-83734

Ideal for high-density applications such as in op amps, timing circuits, memory devices, etc., and packaging standard MOS/LSI dual-in-line devices.

Only .150" high above the circuit board, these low-profile edge wipe sockets maintain their .100" contact centers when butted end-to-end. This provides continuous rows of contacts for universal applications, and high-density packaging.

Special spring design accepts leads as large as .016" x .023. Closed entry insulator design protects spring members and guides component leads. Anti-wicking feature eliminates solder wicking entirely. Body construction permits flux-flushing and subsequent visual inspection. Pins are completely visible for inspection after soldering.

SPECIFICATIONS

Contact Resistance:

15 milliohms (max.) @ 1 amp.

Insulation Resistance:

5000 megohms (min.) @ 500 VDC.

Operating Temperature:

-55°C to +140°C

Materials:

Insulator:
Thermoplastic glass-filled polyester.
Color, black or white

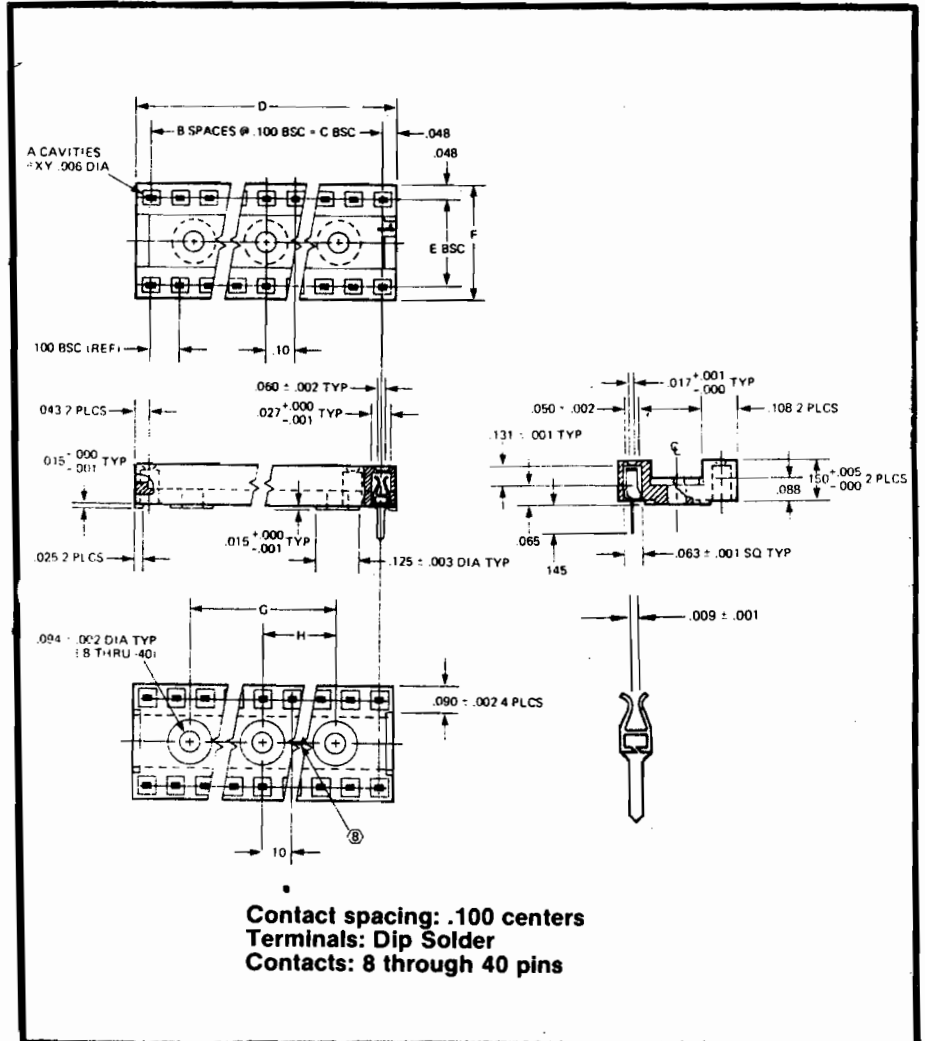

Edge Wipe

	A	B	C	D	E	F	G	H
-08 Pin	8	3	.300	.396	.300	.395	—	—
-14 Pin	14	6	.600	.696	.300	.395	.500	.250
-16 Pin	16	7	.700	.796	.300	.395	.500	.250
-18 Pin	18	8	.800	.896	.300	.395	.500	.250
-22 Pin	22	10	1.000	1.096	.400	.495	.800	.400
-24 Pin	24	11	1.100	1.196	.600	.695	.800	.400
-28 Pin	28	13	1.300	1.396	.600	.695	.800	.400
-40 Pin	40	19	1.900	1.996	.600	.695	.800	.400

Catalog

Order No. Description

IC8	08 Pin IC
IC14	14 Pin IC
IC16	16 Pin IC
IC18	18 Pin IC
IC22	22 Pin IC
IC24	24 Pin IC
IC28	28 Pin IC
IC40	40 Pin IC

BOOK SECTION

A. COMPUTERS

AN INTRODUCTION TO MICROCOMPUTERS, VOL. 1—BASIC CONCEPTS, by Osborne, takes you by the hand, from elementary logic and simple binary arithmetic through the concepts which are shared by all microcomputers. It tells you how to take an idea that may need a microcomputer and create a product that uses one. This book is complete—every aspect of microcomputers is covered: the logic devices that constitute a microcomputer system; communicating with external logic via interrupts, direct memory access, and serial or parallel I/O; microprogramming and macroprogramming; assemblers and assembler directives; linking and relocation—everything you need to know if you are going to select or use a microcomputer.

Catalog Order No. AV1 Paper \$ 7.50

AN INTRODUCTION TO MICROCOMPUTERS, VOL. 2—SOME REAL PRODUCTS, by Osborne, covers real microcomputers, in considerable detail. Every major microcomputer: 4-bit, 8-bit or 16-bit, is described, including some soon to be announced products. Major chip slice products are also covered.

Catalog Order No. AV2 Paper \$12.50

8080 PROGRAMMING FOR LOGIC DESIGN

6800 PROGRAMMING FOR LOGIC DESIGN Both by Osborne. These are completely new books on totally new subject: implementing digital and combinatorial logic using assembly language within an 8080 or 6800 microcomputer system. What happens to fan-in and fan-out? How do you implement a one-shot? These book describe the meeting ground of programmer and logic designer; they are written for both readers.

Catalog Order No. A8080 Paper \$ 7.50

Catalog Order No. A6800 Paper \$ 7.50

MICROPROCESSOR BASICS, Edited by M. Elphick. Aimed at the design engineer, this new volume on microprocessors is a collection of articles which appeared in *Electronic Design* in 1975 and 1976 under a series entitled "Microprocessor basics".

Separate sections are devoted to each of the popular microprocessors currently available. Specific models covered in the book include the 8080, F8, 6800, 2650, 6100, 1802 and PACE. All the microprocessors mentioned are available from two or more vendors.

Each section discusses one available model, explaining its advantages and disadvantages, and its capabilities. Also included are many illustrations of the applications of each microprocessor. You won't find anywhere a more up-to-date volume on the new world of microprocessors.

Catalog Order No. H5763 Paper \$ 9.95

MICROCOMPUTER PRIMER, by Waite & Pardee. The microcomputer explosion is here! This book tells what a microcomputer is and how it works. It explores the basic concepts and characteristics of microcomputer CPUs, memories input/output devices and interfaces, software, hardware, programming techniques and number systems.

Catalog Order No. S21404 Paper \$ 7.95

MICROPROCESSORS: NEW DIRECTIONS FOR DESIGNERS, By Edward A. Torrero. "For the hobbyist hardware expert, the book provides a fair overview of the microcomputer field; for the person more acquainted with software, it gives a good introductory look at the field from a hardware perspective." Byte.

This valuable book offers convenient access to the growing applications and design features in the new world of microprocessors. It's a systematic compilation of the wealth of data, information, statistics, advice and suggestions on microprocessors that has recently appeared in *Electronic Design* magazine.

Catalog Order No. H5777 Paper \$10.95

COMPUTER MATHEMATICS, By Conrad, Conrad, Higley. In this new text, the basic operations of arithmetic, logic, and array arithmetic are simplified into formal languages called the Numeric Calculus, Logic Calculus, and Array Calculus that can serve as a means for communicating with a computer much as languages such as FORTRAN and PL/1 do.

Catalog Order No. H5095 Cloth \$13.95

PROCESSOR ARCHITECTURE, By S. H. Lavington. Several fields overlap in processor architecture: digital electronics, memory systems, compiler writing, operating systems. In this new text, this common theme is pursued from first principle to a discussion of some of the advanced concepts of larger computer systems. Hardware and software design requirements are balanced together throughout the text, forming a useful reference for all concerned with computers.

Catalog Order No. H5457 Paper \$ 8.95

MINICOMPUTERS: STRUCTURE AND PROGRAMMING, By Lewis or Doerr. This introductory text on assembly language, machine architecture, and small machine algorithms is designed for use in computer science courses using small computers. It thoroughly introduces the reader to minihardware and then covers all the essentials needed to program a minicomputer. Section I (Preliminaries) covers number conversion, codes, and provides basic review. Section II (Minicomputing) includes an exceptional chapter on computer organization communications and peripheral devices, and goes on to define a minicomputer. The third section on Software Engineering covers the programming of the PDP-11 minicomputer and algorithms for small machines. Section IV on Microcomputing ends with a chapter on microprogramming.

Catalog Order No. H5642 Paper \$12.95

COMPUTERS IN ACTION, By Donald D. Spencer. This book, vividly illustrated with cartoons, photographs, and diagrams, offers the student and layman a greater understanding of computers and how they work. Its main objectives is to answer such questions as "What are computers?" "How do computers work?" and "What can a computer do?" The book includes a discussion of how computers are used in our society and where the modern computer originated. After dealing with the components of a

basic computer system, the book describes how computers are made to do the work of man. The BASIC programming language is used to illustrate the basics of computer programming.

Catalog Order No. H5861 Paper \$ 5.50

COMPUTERS IN SOCIETY: THE WHERE'S, WHYS, AND HOWS OF COMPUTER USE, By Donald D. Spencer. Exploring the many ways computers are used in our society this book is appropriate as a supplement for courses in introductory computing and technology and as a text in courses introducing the social uses of computers. It examines a wide range of up-to-date applications in medicine, engineering, transportation, business the arts, education, law, process control, and many other areas.

Catalog Order No. H5915 Paper \$ 5.50

COMPUTER CAREERS: PLANNING, PRE-REQUISITES, POTENTIAL, By Maniotes & Quasney. A practical guide for anyone now in, or about to enter, the computer field. It maps out the many career opportunities in the computer field (now and in the future), educational and training opportunities, valuable pointers on choosing the best computer school, and available ways to finance your education.

The book gives a concise, practical rundown of today's computer, its capabilities, functions, and uses. It offers both the newcomer and the experienced professional valuable advice on problems and pitfalls, as well as opportunities and benefits. It will be invaluable to high school or college counselors, teachers, librarians, parents, and anyone considering a career in the computer field.

Catalog Order No. H5913 Paper \$ 5.95

COMPUTERS METHODS FOR SCIENCE AND ENGINEERING, By Robert L. LaFara. Scientists and engineers with computer skills are in demand these days. An excellent professional reference and text this volume offers the computer methods and techniques that scientists and engineers need to solve their numerical problems.

All derivations, proofs and methods are honed down to to pertinent essentials without sacrificing accuracy or thoroughness. You'll find an exceptionally lucid, clear-cut treatment of problem organization and flow-charting.

The text offers basic background on computer hardware and computer organization, and assumes knowledge of FORTRAN or some other programming language.

Catalog Order No. H5766 Cloth \$14.90

I/O DESIGN DATA MANAGEMENT IN OPERATING SYSTEMS, By Freeman & Perry. Now you can master every facet of today's I/O systems more easily than ever before—design your systems with more confidence and accuracy. This handbook, written by two professionals with many years experience in designing and implementing programming systems, details the many I/O system and subsystem designs in use today.

Catalog Order No. H5789 Cloth \$17.50

B. PROGRAMMING

PROGRAMMING MICROPROCESSORS, By M. W. McMurrin. A practical and comprehensive new guide to microprocessor architecture and programming,

Including fixed-point and floating-point arithmetic, data exchange with peripherals, flow-charting, assemblers, compilers, and other programming aids.

Here's a book that bridges the gap between elementary microprocessor programming techniques, and the more sophisticated routines now available. It shows how to make every bit count when it comes to preserving numerical accuracy, how to do arithmetic in fixed-point and floating-point formats (scaling the numbers to make most efficient use of registers and memories), and how to use the various arithmetic/logic operations to perform register manipulations and counting chores.

Catalog Order No. T985 Paper \$ 6.95

MICROPROCESSOR/MICROPROGRAMMING HANDBOOK, By Brice Ward. An authoritative, practical guide to the construction, operation, programming and applications of perhaps the most significant new technological achievement of our time. Tells what microprocessors are, how they work, where they're used, and how YOU can use them in your own applications! Shows you how to write the necessary programs (called microprograms) to allow your microprocessor to process and manipulate information, simulate control processes, and emulate other machines.

Catalog Order No. T785 Paper \$ 6.95

PROGRAMMING PROVERBS, By Henry F. Ledgard.
Catalog Order No. H5527 Paper \$ 6.50

PROGRAMMING PROVERBS FOR FORTRAN PROGRAMMERS, By Henry F. Ledgard. Recently published, both of these books feature 26 ingenious *proverbs* designed to improve your programming accuracy and style. The first contains sample programs in PL/1, ALGOL, and several other languages; the second is specially designed to help FORTRAN programmers improve their skills.

Catalog Order No. H5820 Paper \$ 6.50

COBOL WITH STYLE: PROGRAMMING PROVERBS, By Louis J. Chmura, Jr. The successful technique used in *PROGRAMMING PROVERBS* and *PROGRAMMING PROVERBS FOR FORTRAN PROGRAMMERS* has now been applied to COBOL. This new book features coherent, practical, and common-sense guidelines to writing perfect COBOL programs every time. Here, for the first time for the COBOL user, are *standards* for writing programs and prettyprinting. This handbook also fetures numerous examples of the best written COBOL programs in print today. Every program has been tested and thoroughly debugged.

Catalog Order No. H5781 Paper \$ 5.45

ABC'S OF COMPUTER PROGRAMMING (2nd Edition), By Lytel & Buckmaster. Presents all the fundamentals of digital computer programming. Includes numbering systems, binary notation, punched card codes, arithmetic operations, octal numbering, the hexadecimal system, numbering codes, COBOL and FORTRAN.

Catalog Order No. S20841 Paper \$ 3.95

WHAT TO DO AFTER YOU HIT RETURN, or P.C.C.'s

First Book of Computer Games. By PCC and HP. This book provides a starting point for exploring the uses of computers in the capacity of playmate, tool, and teacher. The computer games and simulations were contributed by a variety of people. It is crammed to the margins with interesting tidbits and graphics—one of those books you feel compelled to pick up, just to see what is inside.

Catalog Order No. PCRET Paper \$ 6.95

101 BASIC COMPUTER GAMES, Edited by David H. Ahl. Digital's 101 Basic Computer Games is not the first collection of computer games and simulations nor will it by any means be the last. However, in many ways it is unique. It is the first collection of games all in BASIC. It is also the only collection containing both a complete listing and a sample run of each game along with a descriptive write-up.

Catalog Order No. CC101 Paper \$ 7.50

GAME PLAYING WITH COMPUTERS, revised Second Edition. By Donald D. Spencer. Now you can sharpen programming skills through a relaxed and radically different approach. Completely devoted to computerized game playing, this volume presents over 70 games, puzzles, and mathematical recreations for a digital computer. It's fully illustrated and includes more than 25 game-playing programs in FORTRAN or BASIC, complete with descriptions, flowcharts, and output.

Catalog Order No. H5103 Cloth \$16.95

BASIC BASIC: AN INTRODUCTION TO COMPUTER PROGRAMMING IN BASIC LANGUAGE, By James S. Coan. This text for high school and college students integrates programming in BASIC language and the teaching of mathematics. Written in a precalculus setting, it is suitable either as a supplementary text within already established math courses or as the sole text in a course on programming alone.

Each topic begins with a short, complete program and progresses to more sophisticated problems. The use of flow-charts is encouraged as an aid in writing programs. Summaries and questions allow the student to gradually increase both his understanding of concepts and his ability to write programs.

Catalog Order No. H5872 Paper \$ 7.95

DISCOVERING BASIC: A PROBLEM SOLVING APPROACH, By Robt. E. Smith. This course introduces programming through a practical approach to learning that motivates the reader to discover the vocabulary of the BASIC language as he develops skill and confidence in putting it to work.

The brief lessons, usually two pages long, are explained in clear, concise language and are followed by review problems. Over thirty-five pages of programs Back up both lessons and problems. A wide range of interests including insurance, geometry, puzzles, and economics is covered in the lessons which reflect the growing importance of BASIC as a language used with time-sharing systems in computer installations and for programming microcomputers.

Catalog Order No. H5783 Paper \$ 6.85

ADVANCED BASIC APPLICATIONS AND PROBLEMS, By James S. Coan. Both professionals

and students usually find that after they have been through introductory BASIC books, they're pretty much left on their own. This book is for those who want to extend their expertise with BASIC and offers advanced techniques and applications including coordinate geometry area sequences and series, polynomials, graphing, simulations and games. A special review chapter is given for those whose knowledge of BASIC is limited or distant in time. The book is also intended for those who already know another programming language and want to pick up BASIC.

Catalog Order No. H5855 \$6.95

COMPUTER PROGRAMMING HANDBOOK, By Peter Stark. A complete guide to computer programming and data processing, with scores of worked-out examples. An extremely comprehensive, informative, and interesting work on digital computer programming, and data processing in general. And it doesn't require a knowledge of higher mathematics to understand and use! This GIANT text covers all three types of computer languages machine, symbolic, and problem-oriented (which focuses on FORTRAN IV—the universal language): each type is covered in detail, complete with worked-out examples which include computer printouts and actual results. If ever there was a one-book course on computer programming, this is it!

Catalog Order No. T752 Paper \$8.95

MY COMPUTER LIKES ME...WHEN I SPEAK BASIC. An introduction to BASIC...simple enough for your kids. If you want to teach BASIC to anyone quickly, this booklet is the way to go.

Catalog Order No. PCL2 \$2.00

FORTRAN FUNDAMENTALS: A SHORT COURSE. By Jack Steingraber. Beginning programmers with some mathematical background will find this text a fast and efficient guide to the fundamentals of FORTRAN. The main objectives are to provide an abbreviated means of learning the language to introduce format statements to encourage immediate results, and to make students familiar with their language manuals.

Sample problems are given along with complete solutions however, students are consistently encouraged to try various routines and to analyze their success or failure. Questions appear throughout the text and are designed to be answered with reference to the FORTRAN manual being used. Although the text is ideal for self-study, it was designed for a FORTRAN class of approximately 10 hours.

Catalog Order No. H5860 Paper \$4.95

COMPREHENSIVE STANDARD FORTRAN PROGRAMMING, By James N. Haag. This text teaches how to program effectively using the full version of FORTRAN IV as standardized by the American National Standards Institute. It provides a mastery of the 32 different FORTRAN IV instructions, as well as an understanding of computer capabilities and limitations. From the outset, portions of the language are applied in writing complete programs, until by the end of the text, the reader has the capacity to solve numerous problems.

Requiring no previous knowledge of computers or programming, the book employs examples and exercises drawn from general experience to show how to apply the complete language in solving the problems of a variety of disciplines.

Catalog Order No. H5811 Paper \$8.95

C. DIGITAL AND ELECTRONICS

DIGITAL TROUBLESHOOTING: PRACTICAL DIGITAL THEORY AND TROUBLESHOOTING TIPS. By Richard E. Gasperini. New digital products are presenting as big a challenge to service personnel as did the change from vacuum tubes to transistors. The thrust of this new handbook is practical digital theory and troubleshooting, so it is ideal for all engineers and technicians, it was originally developed as a training program for Hewlett-Packard and includes new test instruments that will replace or extend the oscilloscope in troubleshooting.

Catalog Order No. H5708 Paper \$9.95

FUNDAMENTALS AND APPLICATIONS OF DIGITAL LOGIC CIRCUIT. By Sol Libes. Digital logic circuits are finding widespread applications in instrumentation, process control, even consumer products. If you have a basic knowledge of electronics, this book will supply you with all the information you need to get into the new era of digital electronics. You'll find everything from the basic theory to the most advanced applications—including the complete circuitry of calculators, digital voltmeters, frequency counters, as well as the latest computer applications. The book explores the applications of RTL, DTL, TTL, and other gating circuits. The presentation is simple and direct—neither math nor Boolean algebra is needed to understand these circuits and systems. Objective exam available.

Catalog Order No. H5505 Paper \$6.95

DIGITAL SIGNAL ANALYSIS. By Samuel D. Stearns. This important handbook features recent advances in the field, new design materials, and a comparison between continuous and digital systems.

Areas covered include sampled-data systems and analog-to-digital conversion; discrete and fast Fourier transforms nonrecursive and recursive digital systems; simulation of continuous systems; digital filter analysis; and digital time series synthesis and analysis. There is also brand-new material on waveform reconstruction.

The appendices, especially valuable to the practicing engineer, include an extensive table of Laplace and z transforms, as well as useful FORTRAN routines for solving linear equations, computing the fast Fourier transform, and finding digital filter coefficients.

Catalog Order No. H5828 Cloth \$19.95

111 DIGITAL & LINEAR IC PROJECTS. By Don Tuite. A practical sourcebook of circuits for every taste—digital and linear—using off-the-shelf components. Complete specs and clear layout drawings are provided for every IC (including phase locked loop featured, and detailed applications into including all the values needed to make it work, accompanies each circuit project. The projects themselves, too numerous to mention, cover a broad spectrum that touches every phase of electronics—audio, computers, radio, test instruments, power supplies and regulators, and MANY more. Includes an Appendix providing basic performance data and busing diagrams on 50 common and uncommon IC's.

Catalog Order No. T780 Paper \$5.95

MODERN GUIDE TO DIGITAL LOGIC—PROCESSORS, MEMORIES AND INTERFACES. By United Technical Publications. For the first time

anywhere, the problem of interfacing high-speed logic with lower-speed logic and memory systems is taken up in depth. Emphasizing interfacing, this truly modern guide contains up-to-date data on the most advanced logic circuits used in today's digital systems—such as minicomputers and microprocessors. It's a veritable factbook of design info on Schottky TTL, high-speed ECL, high noise immunity logic. CMOS logic, microprocessors, and bipolar and MOS memory systems. Not only does the book fully discuss the basic logic families, but it fully illustrates how to design and interface logic and memory systems, using the latest techniques and digital ICs. Design factors of microprocessors, including programming time, are discussed in relation to overall system objectives.

Catalog Order No. T709 Paper \$6.95

TV TYPEWRITER COOKBOOK. By Don Lancaster. An in-depth coverage of tv typewriters (tv't's)—the only truly low-cost microcomputer and small-systems display interface. Covers tvt terminology, principles of operation, tvt configurations, memories, system design, cursor and update circuitry and techniques, truly low-cost microcomputer and small-systems encoders. 256 pages; 5½x8½; softbound.

Catalog Order No. S21313 Paper \$9.95

Insert the word softbound above

ITL COOKBOOK. By Donald Lancaster. A complete and detailed guide to transistor-transistor logic (TTL) Explains what TTL is, how it works, and how to use it. Discusses practical applications, such as a digital counter and display system, events counter, electronic stopwatch, digital voltmeter, and digital tachometer. 336 pages; 5½x8½; softbound.

Catalog Order No. S21035 \$8.95

OP AMP CIRCUIT DESIGN & APPLICATIONS. By Joseph Carr. An easy-to-read, easy-to-understand, no-frills volume with ALL the applications info you need to put op amps, right to work for you...you can design your own functional circuits as well as adapt the author's designs to your own requirements.

Catalog Order No. T787 Paper \$6.95

IC OP-AMP COOKBOOK. By Walter G. Jung. The first book of its kind to be published. Covers not only the basic theory of the IC op amp in great detail, but also includes over 250 practical circuit applications, liberally illustrated. Organized into three basic parts introduction to the IC op amp and general considerations, practical circuit applications, and appendixes of manufacturers' reference material.

Catalog Order No. S20969 Paper \$12.95

110 CMOS DIGITAL IC PROJECTS. By Marston. This valuable handbook first outlines the operating characteristics of CMOS and then presents 110 CMOS digital IC circuits ranging in complexity from simple inverter gate and logic circuits to more complex electronic alarm circuits. They are technically interesting and time-and-money-saving for the amateur and professional engineer.

Catalog Order No. H0856 Paper \$4.95

UNDERSTANDING CMOS INTEGRATED CIRCUITS. By Meler & Garland. Takes a building-block approach to the subject of complimentary metal-oxide semiconductors physics. CMOS fabrication technology and design, and advanced CMOS regular applications.

technology and design, an advanced CMOS applications.
Catalog Order No. S21129 Paper \$4.95

BUILD YOUR OWN WORKING ROBOT, By David Heiserman. Here are complete instructions—plans schematics, logic circuits, and wiring diagrams—for building Buster, the most lovable (and mischievous) mechanical pet in the world! He'll forage for his own "food" and scream when he can't find it. His "curiosity" will get him into one plight after another, but Buster has the capacity to get himself out of trouble just as easily as he got into it! Not a project for novices, Buster is a sophisticated experiment in cybernetics. You build him in phases, and watch his personality develop as you add progressively more advanced circuitry to his mainframe. The first/phase robot, Buster I, is "leashed" and dependent on his master for decision-making you create the "animal" and give him wheels, steering capability, in the capacity to "understand" your basic commands. Phase 1 makes Buster more independent.

Now he has a basic brain he can use to decide when he's "hungry" (in need of battery charge), or trapped into a physically binding situation he can't get out of. Properly equipped with a wireless mike and a simple receiver, he can enter a room and talk with the occupants...or scoot around the floor, chase the cat, or perform ballet maneuvers. Buster III usually responds when called (not always, though—he's as unpredictable as a chimp). You can take him for walks and laugh as he inspects your neighbors' driveways or follows children down the block. When he gets "hungry", he searches until he finds his charger; and when he does find it, he plugs himself in and settles down for his feeding. You'll love Buster and you'll enjoy watching his personality evolve as you build him from the ground up. You'll find the learning experience totally unparalleled in electronic construction.

Catalog Order No. T84I Paper \$5.95

CMOS COOKBOOK, By Don Lancaster CMOS (complimentary metal-oxide-semiconductor), the newest digital logic family has gained wide acceptability because of low cost and availability of hundreds of CMOS devices from several manufacturers. This book gives all information needed to understand and use CMOS.

Catalog Order No. S21398 Paper \$9.95

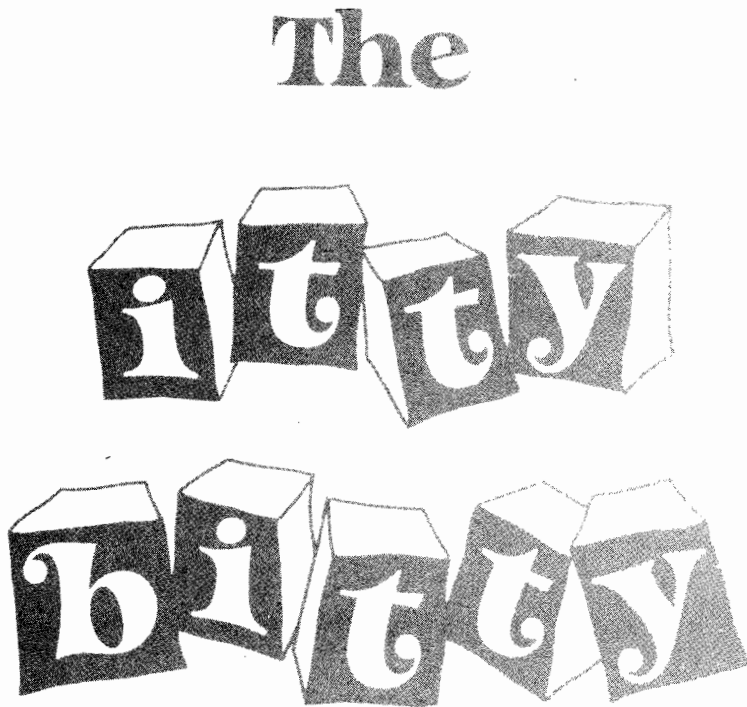

machine co., inc.

ORDER INSTRUCTIONS

1. **DELIVERY TIME:** Most shipments will be within 48 hours. The itty bitty machine company tries to stock all items listed in this catalog but, in many cases delivery time will depend on manufacturers availability. For example, this catalog lists several items which have been announced as new products by manufacturers, but we do not expect delivery of these items for several months. If we do not anticipate delivery of your order within 30 days, we will notify you immediately.
2. **MINIMUM ORDER:** The minimum order that will be accepted is \$10.00.
3. **HANDLING CHARGE:** All orders under \$50.00 require a \$2.00 handling charge.
4. **SHIPPING:** We pay the shipping on all orders.
5. **INSURANCE:** We insure all orders at our expense.
6. **PERSONAL CHECKS:** Allow 21 days for all personal checks to clear our bank. Therefore, all orders paid for by personal checks will be shipped 21 days after we receive your order.
7. **INSUFFICIENT PAYMENT:** If sufficient payment is not remitted with the order, the order will be shipped C.O.D. for the remainder. C.O.D. charges will be added to your bill.
8. **SHIPPING:** All shipping will be by best way, unless otherwise specified.
9. **CREDIT:** No shipments will be for credit, unless your credit has been approved by our credit department. Phone our order desk for a credit application.
10. **CORPORATE ORDERS:** Orders from corporations will not be filled unless signed by an authorized agent of the corporation.
11. **GOVERNMENTAL ORDERS:** No orders from governmental bodies or agencies will be accepted unless signed by an authorized agent.
12. **PAYMENT:** Payment will be accepted by money order, certified check, Master Charge, VISA, BankAmericard or personal check (see item 6, above). Send no CASH.
13. **QUOTATIONS:** Check with us on orders above \$15,000 for special quoted prices.
14. **EDUCATIONAL DISCOUNT:** All tax exempt educational institutions will receive at least a 5% discount on all orders.
15. **ORDER FORM:** Please include the Catalog Order No., short description, unit price, and total price of all items ordered. Complete all other required information on the order form so we can process your order promptly.

TELEPHONE ORDERS: Telephone orders on Master Charge, BankAmericard or VISA will be accepted between the hours of 9:00 a.m. and 9:00 p.m. C.S.T., on Monday, Tuesday, Thursday, Friday; and between the hours of 10:00 a.m. and 5:00 p.m. C.S.T. on Wednesday and Saturday. CALL AREA CODE 312-328-6800.

ALL PRICES AND SPECIFICATIONS IN THIS CATALOG ARE SUBJECT TO CHANGE WITHOUT NOTICE.

Please visit our Computer Stores

The

itty

bitty

machine co., inc.

1322 CHICAGO AVENUE
EVANSTON, ILLINOIS 60201
312-328-6800

42 WEST ROOSEVELT ROAD
LOMBARD, ILLINOIS 60148
312-620-5808

If you don't see a product in our
catalog, give us a call

itty bitty machine co.
42 W. Roosevelt Rd.
Lombard , Il. 60148

BULK RATE
U.S. POSTAGE
PAID
PERMIT NO. 292
LOMBARD, IL.